

The Light Book.

INDELAGUE GROUP

iNDELAGUE ROXO lighting

ÍNDICE GENERAL



6th ELEMENT	29	LNS IP	664
AURA	451	NOAH	59
AVL	793	OREO	207
AVT	656	PAS	781
bLED	641	REBA	495
CAB	757	REBA 50 bOPTICS	465
CLOUD	633	ROFY	155
CONCEPT 35	71	ROFY SQ	197
CONCEPT 65	131	SENSE	415
CORA	617	SLIM	455
DORIS	751	TALEA	669
DYNA	429	TEI	637
ELI	325	THE	658
ELI 50	281	THS	660
FESAL	419	TRN	789
FOCUS 2	359	TTP	695
GLAM	241	TTP 50 360	733
HOLI	387	TTP 70 Colour	743
LNE	645	VEGA	363
LNE IP	662	VISA	459
LNS	649	ZLP	765

ILUMINACIÓN ARQUITECTÓNICA	27
SISTEMAS EN PERFIL DE ALUMINIO	463
ILUMINACIÓN TÉCNICA	615
HOSPITALES Y SALAS BLANCAS	653
LUMINARIAS TUBULARES	667
LUMINARIAS ESTANCAS	749
AMBIENTES INDUSTRIALES Y DEPORTIVOS	755
LUMINARIAS ANTIVANDÁLICAS	763
REGLETAS & CARRIL DE ALUMBRADO	779
SISTEMA DE CARRIL	797
INFORMACIÓN TÉCNICA	803

Todos los datos contenidos en este catálogo no constituyen ningún compromiso por parte de INDELAGUE - Industria Eléctrica de Águeda, S.A.. La empresa se reserva el derecho de efectuar las modificaciones que considere oportunas, sin previo aviso. Está prohibida la reproducción, incluso parcial de este catálogo. Los datos eléctricos / ópticos están sujetos a una tolerancia de +/- 10%. La temperatura de color está sujeta a una tolerancia de +/- 150°K, excepto cuando se especifique claramente. Todos los valores se aplican a una temperatura ambiente de 25°C.

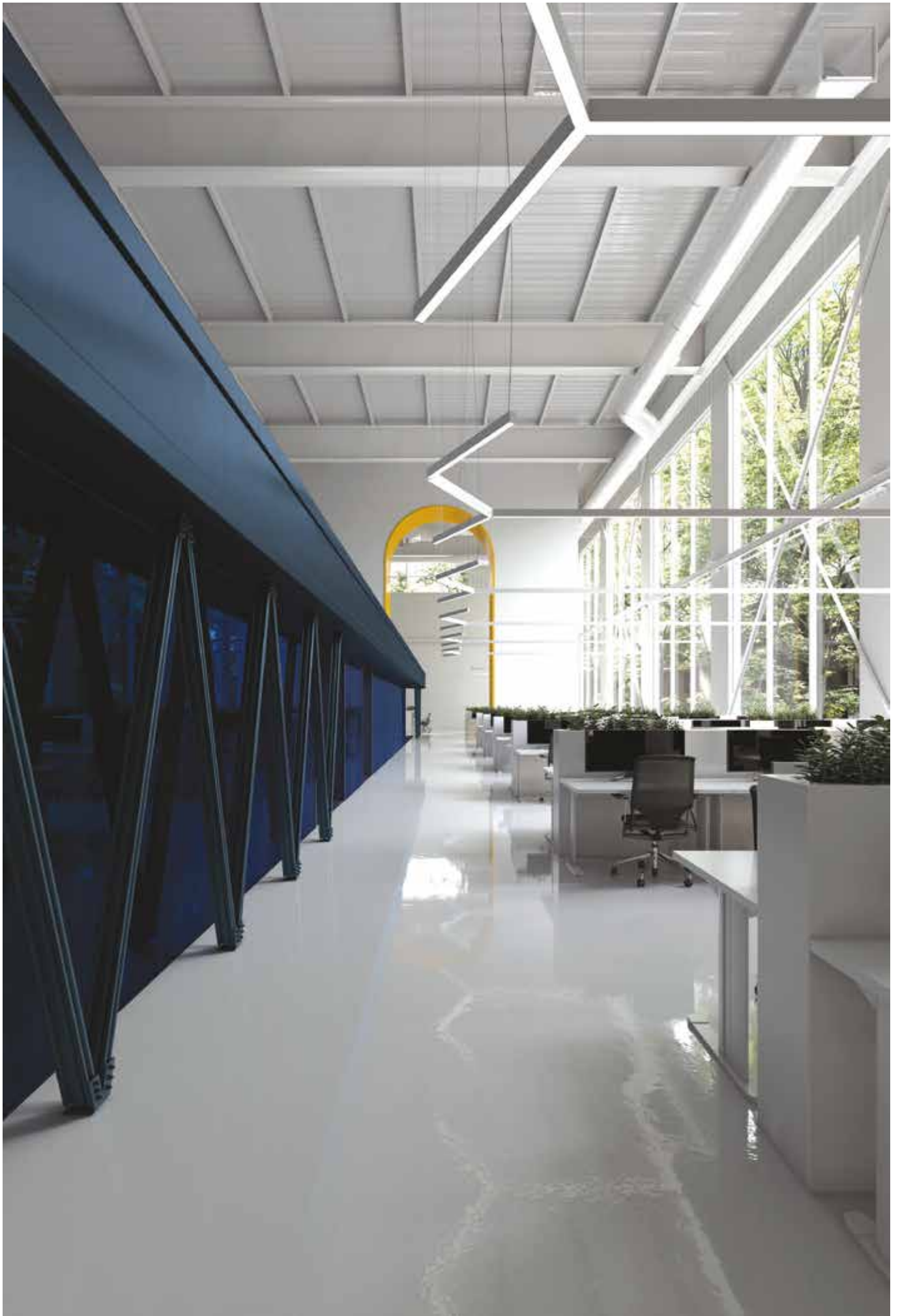

Índice

ILUMINACIÓN ARQUITECTÓNICA

EMPOTRAR

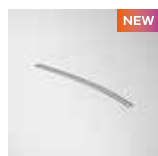

CONCEPT S 35 / E
90



CONCEPT O 35 / E
104



ROFY 60 / T
166



ROFY 60 / T D/I
168



ROFY 85 / E
180



ROFY 85 IP / E
190

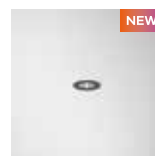

ELI 50 / E 1
284

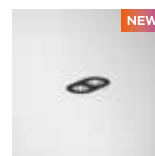

ELI 50 / E 2
286

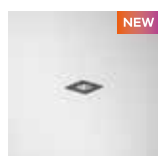

ELI 50 Sq / E 1
288

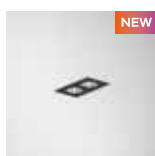

ELI 50 Sq / E 2
290

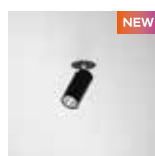

ELI 50 Spot / E 1
314

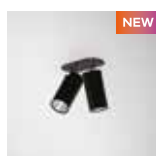

ELI 50 Spot / E 2
316

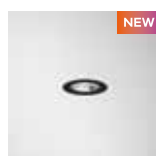

ELI / E 1
328

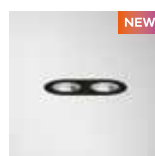

ELI / E 2
330

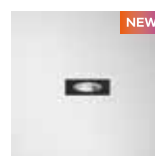

ELI Sq / E 1
332

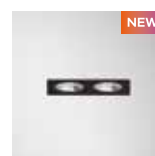

ELI Sq / E 2
334



VEGA / E
366



VEGA Sq / E
368



VEGA IP / E
378



VEGA Sq IP / E
380



HOLI Sq / T Mini
388



HOLI Sq / T
390



HOLI Sq / T Max
392



HOLI Sq Mini
396



HOLI Sq
398



HOLI Sq Max
400



HOLI Sq / AS Max
404



SENSE
416



FESAL
420



FESAL Sq
422

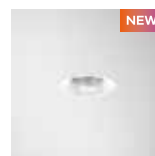

FESAL IP
424



FESAL Sq IP
426



DYNA MINI
430

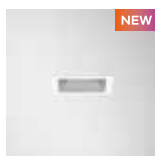

DYNA MINI Sq
432



DYNA
438



DYNA Sq
440



DYNA IP
444



DYNA Sq IP
446

SUPERFICIE / SUSPENDER

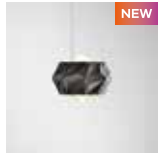

6th ELEMENT +
36



6th ELEMENT
40



6th ELEMENT FIX
44



6th ELEMENT /C
48



NOAH
62



CONCEPT S 35
94



CONCEPT S 35 D/I
98



CONCEPT O 35
106



CONCEPT O 35 D/I
110



CONCEPT Sq 35
114



CONCEPT Sq 35 D/I
118



CONCEPT D 35
122



CONCEPT D 35 D/I
126



CONCEPT S 65
138



CONCEPT S 65 D/I
142



CONCEPT O 65
146



CONCEPT O 65 D/I
150



ROFY 60
172



ROFY 60 D/I
176



ROFY 85
182



ROFY 85 D/I
186



ROFY 85 IP /C
192



ROFY 60 Sq
198



ROFY 60 Sq D/I
202



OREO /C
214



OREO In
216



OREO Out
220



OREO V In
224



OREO V Out
228



OREO Linea Down
232



OREO Linea Up
236



GLAM
248



GLAM S4
254



GLAM S8
258



ELI 50
294



ELI 50 Sq
296

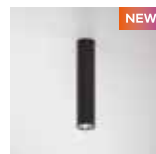

ELI 50 /C
300



ELI 50 Sq /C
302



ELI 50 Spot /C
318



ELI
338



ELI Sq
340

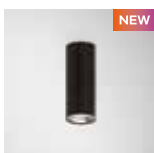

ELI /C
342



ELI Sq /C
344



VEGA
372



VEGA Sq
374



VEGA IP
382



HOLI Sq /C Mini
406



HOLI Sq /C
408



HOLI Sq /C Max
410



DYNA MINI /C
434



DYNA /C
442

Índice

PARED



6th ELEMENT /W
54



GLAM /WE
264



GLAM /W
268



ELI 50 /W
306

NEW



ELI 50 Sq /W
306

NEW



ELI 50 /W D/I
308

NEW



ELI 50 Sq /W D/I
310

NEW

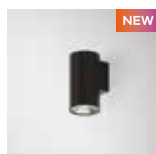

ELI /W
348

NEW

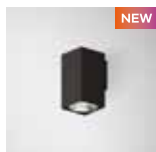

ELI Sq /W
350

NEW



ELI /W D/I
352

NEW



ELI Sq /W D/I
354

NEW



AURA
452



SLIM
456



VISA
460

PROYECTOR Y CARRIL



GLAM 48V
274



ELI 50 Spot Track
320

NEW



FOCUS 2
360

NEW



Sistema de carril
800

LUMINARIA DE MESA



NOAH /D
68

SISTEMAS Y PERFILES
DE ALUMINIO

EMPOTRAR



**REBA 50 /E
bOPTICS**
474

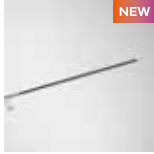

**REBA 50 /E
bOPTICS Line**
478



REBA 50 /T
512

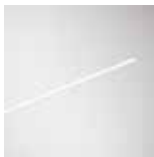

REBA 50 /T Line
516



REBA 50 /E
522



REBA 50 /E Line
526



REBA 65 /T
574



REBA 65 /T Line
578



REBA 65 /E
584



REBA 65 /E Line
588

SUPERFICIE / SUSPENDER

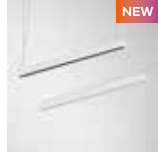

REBA 50 bOPTICS
484



**REBA 50 bOPTICS
Line**
488



REBA 50
532



REBA 50 Line
536



REBA 50 HEXA
546



REBA 50 D/I
550



REBA 50 D/I Line
554



REBA 65
594



REBA 65 Line
598



REBA 65 D/I
604



REBA 65 D/I Line
608

PARED



REBA 50 /W
560



REBA 50 /W Line
564

Índice

ILUMINACIÓN TÉCNICA

EMPOTRAR



CORA / E
620



CLOUD
634



TEI
638



bLED
642



LNE
646

SUPERFICIE / SUSPENDER



CORA
624



CORA / C
628



LNS
650

AMBIENTES ASÉPTICOS

EMPOTRAR



AVT
656



THE
658



LNE IP
662

SUPERFICIE



THS
660



LNS IP
664

LUMINARIAS TUBULARES

SUPERFICIE / SUSPENDER



TALEA
678



TALEA Line
682



TALEA Glare
690



TTP 50 Line
712



TTP 70 Line
720



TTP 100 Line
728

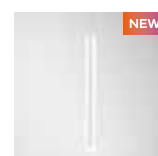

TTP 50 360 VRT
738



TALEA HRZ
678



TALEA Glare / C
686



TTP 50
708



TTP 70
716



TTP 100
724



TTP 50 360 HRZ
734



TTP 70 Colour
746

**LUMINARIAS
ESTANCAS**

**SUPERFICIE /
SUSPENDER**

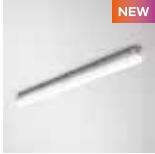

DORIS
752

**AMBIENTES INDUSTRIALES
Y DEPORTIVOS**

**EMPOTRAR / SUPERFICIE /
SUSPENDER**



CAB
758

**LUMINARIAS
ANTIVANDÁLICAS**

EMPOTRAR



ZLP /E
766

**REGLETAS &
CARRIL DE
ALUMBRADO**

SUPERFICIE



TRN
790



AVL
794

**SUPERFICIE /
SUSPENDER**



ZLP
768

SUSPENDER



ZLP /C
772



PAS
782



ZLP /W
774



PAS Line
784

INTRODUCCIÓN



Quiénes somos

Fabricamos iluminación desde principios de los años 80. Estamos orgullosos de nuestro trabajo y de nuestra historia.





Quiénes somos

Somos especialistas en iluminación sostenible con tecnología LED. Una empresa familiar, ubicada en Águeda, en el corazón de Portugal, que opera como un actor global con ventas independientes y alianzas comerciales en alrededor de 35 países. Fundados en 1978, hemos sido pioneros en el desarrollo de la iluminación técnica y arquitectónica en Portugal, desde nuestra fundación hasta la actualidad. Somos el primer fabricante portugués en establecer una cartera de producción basada exclusivamente en tecnología LED. La estrategia corporativa para la iluminación sostenible combina la responsabilidad ecológica con el conocimiento tecnológico. Nuestros 100 empleados están comprometidos y dedicados a garantizar que nuestros productos no sean solo productos, sino herramientas de iluminación sostenible adecuadas para su proyecto.

45 años de historia

Crear soluciones de iluminación estéticas y de calidad es nuestra pasión.

Llevamos 45 años trabajando continuamente en la luz del mañana con un enfoque de diseño único. Contribuimos a mejorar la calidad de la vida humana a través de la luz, ofreciendo la luz adecuada para cada actividad en cualquier momento del día o

de la noche. El desarrollo continuo de la cartera de productos no sólo está impulsado por la investigación y la tecnología más avanzadas, sino sobre todo por una larga colaboración con arquitectos, ingenieros, diseñadores de iluminación e internacionales de

renombrados en sus trabajos de diseño. Nuestras luminarias se adaptan siempre a las necesidades individuales de nuestros clientes y de las personas que utilizan nuestros productos.

1978

Fundación de la empresa.



1985-86

Desarrollo de los primeros productos de iluminación IRN y IAI.
Desarrollo de productos de iluminación IAP e inicio de la producción de sistemas de bandejas portacables.



1987

Ampliación de capacidad de fabricación con la construcción de una nueva nave de 900 m² y el inicio de la producción de reflectores de aluminio para los modelos LAE y LAS.



1993

Ampliación de la capacidad fabril con la construcción de un nuevo pabellón de 1000 m².



2007

Construcción de la nueva sede.
Una inversión de 10 millones de euros permitió construir una nueva fábrica de 17000 m².
También se adquirió un nuevo laboratorio fotométrico, varias máquinas CNC y un nuevo sistema de línea de pintura.



2012

Se crea la marca **ROXO LIGHTING**.
Inicio de la producción de iluminación arquitectónica, incluida una nueva gama de downlights.

ROXO lighting

2014

Desarrollo e inicio de producción de la gama REBA 65 en perfil de aluminio, la gama TTP 70 con un alto nivel de protección y la gama ZLP con alta resistencia mecánica y antivandalismo.

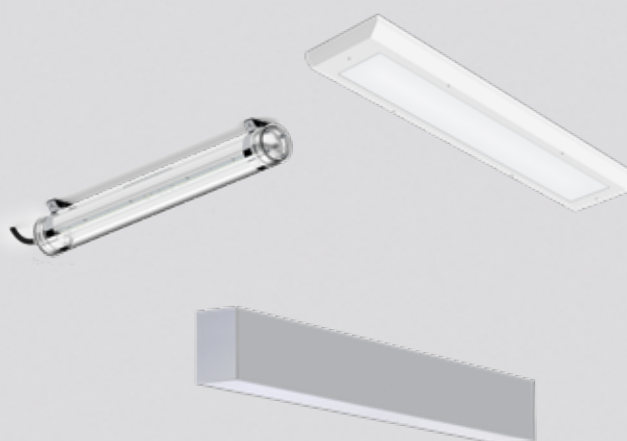

45 años de historia

2017

El **6th ELEMENT** ganó el prestigioso Premio Alemán de Diseño - Special Mention 2017.



2018

El jurado del Premio Alemán de Diseño otorgó a la luminaria **NOAH** del grupo Indelague el Premio Alemán de Diseño - WINNER 2018.

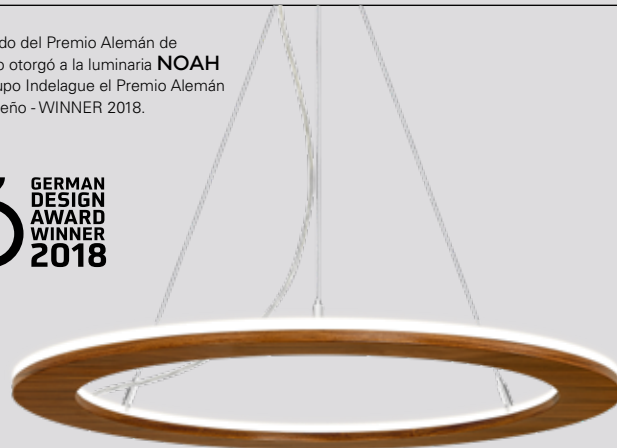

2019

En 2019 decidimos invertir en un perfil más ecológico y socialmente sustentable en nuestra unidad fabril a través de la instalación de 600 paneles solares fotovoltaicos con una potencia máxima de 295W y capacidad de producir 235000 kWh de energía eléctrica al año a partir del sol. Permitiendo la reducción del impacto ambiental, evitando la emisión de 120 toneladas de CO2 al año.

2020

La gama **TALEA** ha ganado el aclamado German Design Award 2020, ganando la categoría "Excellent Product Design Lighting".

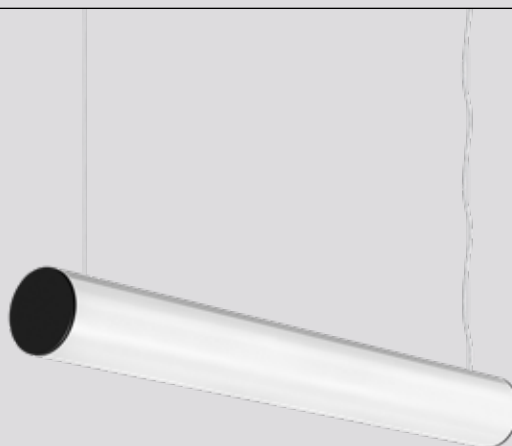

2021

Nuestro producto **CONCEPT S 35** recibió el premio German Design Award 2021 con la "SPECIAL MENTION" en la categoría de iluminación.

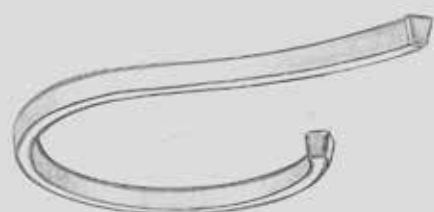

2022

6ª participación de Indelague en la feria Light+ Building de Frankfurt, Alemania, donde expuso sus soluciones de iluminación que combinan innovación, sostenibilidad y diseño.

2023

Indelague cumple **45 años** de excelencia y experiencia en el sector de la iluminación. Remodelación del showroom.



I+D y diseño



Nuestros productos son el resultado de una constante y continua investigación en diferentes áreas.

I+D e Diseño

El departamento de I+D (Investigación y Desarrollo) desempeña un papel destacado en las actividades del Grupo Indelague. La estrecha relación con nuestros clientes es fundamental para estar al día de las últimas novedades del mercado, lo que motiva a nuestro equipo de I+D a investigar nuevos materiales y realizar ensayos cada vez más rigurosos, permitiendo al Grupo Indelague garantizar

un alto nivel de tecnología y estándares únicos de calidad. El equipo de I+D se dedica a la investigación y desarrollo de productos LED innovadores, mediante pruebas (técnicas y fotométricas) en nuestro propio laboratorio y mediante colaboraciones con laboratorios independientes. Nuestros productos son el resultado de una constante y continua investigación en diferentes áreas. Desde componentes

electrónicos y ópticos, hasta diseño y fotometría, enfocados en productos que incorporan tecnología avanzada con materiales sostenibles y un diseño atemporal. Desarrollamos constantemente procesos de producción altamente avanzados para lograr un menor consumo de energía, una mayor vida útil del producto, temperaturas de funcionamiento optimizadas, nuevos efectos de iluminación y excelentes rendimientos.



Nuevos productos

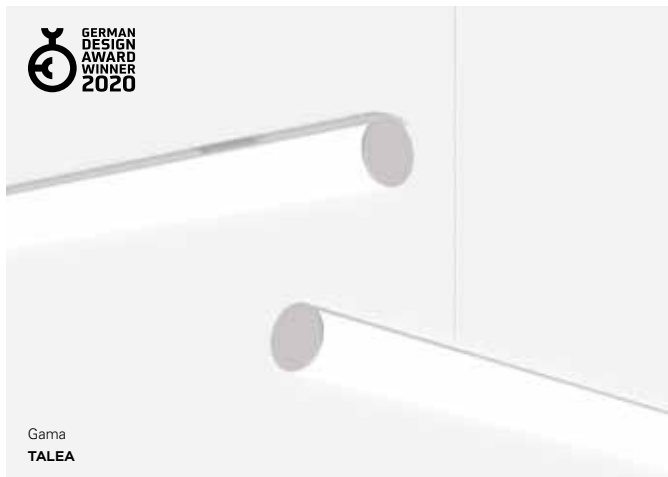

Gama
TALEA



Gama
OREO

Nuevos productos

Presentamos nuestras últimas soluciones en iluminación LED. Innovadores, fiables y eficientes, se adaptan a cualquier espacio y se integran en cualquier tipo de ambiente. Están diseñados para aplicaciones versátiles, soluciones verdaderamente únicas para cualquier espacio arquitectónico. Nuestras luminarias son herramientas de iluminación que integran la más alta tecnología y niveles excepcionales de rendimiento lumínico, permitiéndoles lograr efectos de iluminación acentuados, precisos o uniformes. Las nuevas gamas ofrecen nuevas perspectivas en el diseño de iluminación para oficinas, salas de conferencias, instalaciones educativas y edificios administrativos.



Gama
CORA



Gama
ROFY

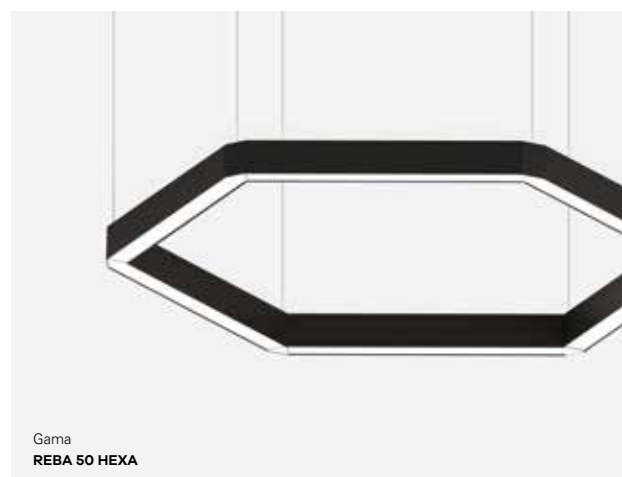

Gama
REBA 50 HEXA



**La luz es mucho más
que diseño, material y
tecnología.
¡La luz es una experiencia!**



Proyectos de referencia





INTRODUCCIÓN

Rodi
Aveiro, Portugal

Proyectos de referencia

Definimos continuamente nuevas formas de crear productos de iluminación para nuevos contextos de aplicación. Los proyectos culturales, sociales y urbanos nos ofrecen nuevas oportunidades y conocimientos, que nos permiten resaltar detalles, superficies y volúmenes arquitectónicos. La iluminación evoluciona rápidamente hacia una profunda revolución arquitectónica. Es un elemento fundamental para la calidad y el bienestar de cualquier tipo de

ambiente incluyendo oficinas, tiendas minoristas, museos, instituciones educativas, hogares, parques y jardines. El Grupo Indelague ofrece soluciones de iluminación sofisticadas y de valor añadido. Disponemos de gamas de productos que cubren diversos sectores de aplicación. A lo largo de los años, hemos adquirido experiencia y conocimiento para satisfacer las necesidades funcionales y estéticas de sus proyectos.

Cada proyecto requiere un enfoque personalizado, y en este sentido creamos el Departamento de Proyectos de Iluminación que ofrece el apoyo necesario a nuestros clientes, arquitectos, ingenieros, interioristas y light designers. También tenemos paquetes de servicios excepcionales y herramientas de diseño a su disposición. Nuestro equipo global trabaja con todas las partes interesadas para obtener el mejor resultado posible.



Utopia
Aalst, Belgium



Dr. Cautela Dental Clinic
Lisbon, Portugal

Capítulo
01

ILUMINACIÓN ARQUITECTÓNICA





6th ELEMENT

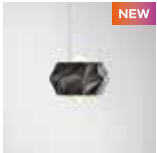

6th ELEMENT +
36



6th ELEMENT
40



6th ELEMENT FIX
44



6th ELEMENT /C
48



6th ELEMENT /W
54



Tipos de aplicación





1. Semiempotrar Fijo

2. Pared Orientable

3. Semiempotrar Orientable

4. Suspendida

Minimalismo y tecnología



140 mm

1. Cuerpo
Cuerpo de aluminio inyectado,
disponible en 3 colores.

2. LED
SDCM MacAdam ≤ 3 ,
temperatura de color 3000K /
4000K, CRI > 80 y vida útil
de 80.000h L90 B10.

3. Sistema óptico
3.1 Lente de 50°
3.2 Lente de 80°

4. Suspensiones y cable de alimentación
Suspensiones y cable de
alimentación disponibles
en longitudes de 1500,
3000 o 6000 mm.

5. Base de alimentación
Bases empotradas o de
superficie.
Disponibles en blanco o negro.

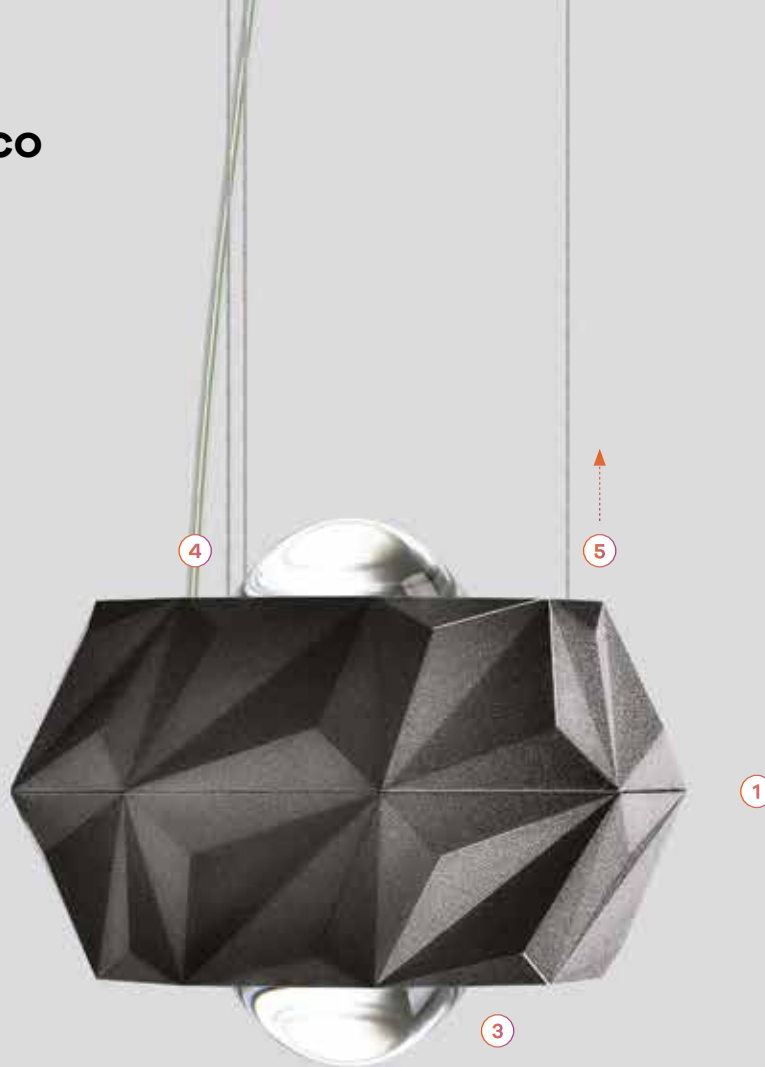

3.1. Lente de 50°

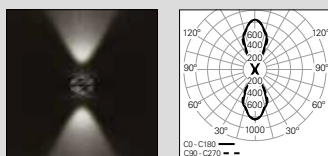

3.2. Lente de 80°

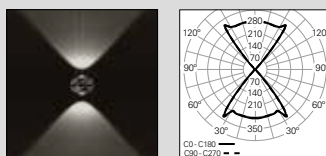

Defina su color

ILUMINACIÓN
ARQUITECTÓNICA





6th ELEMENT +



Características del productos

Cuerpo

Aluminio inyectado



Acabado

Pintado en epoxi-poliéster



Sistema óptico

Lente



Fuente de luz

LED, RG1, CRI>90, MacAdam Step ≤3

Vida útil del LED

50.000h @ L80, B10, Ta 25°C

Fuente de alimentación

No incluida

01. Seleccionar versión

6th ELEMENT +

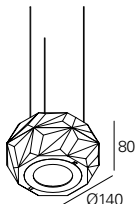

Lente de 50° | Directa / Indirecta (50%/50%)

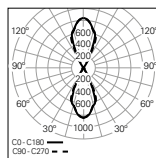

UGR	W	lm output	lm/W	mA	CÓDIGO*
≤10	17	2232	131	500	90568L0160▲0◆50

Lente de 80° | Directa / Indirecta (50%/50%)

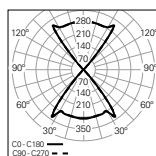

UGR	W	lm output	lm/W	mA	CÓDIGO*
≤19	17	2158	127	500	90568L0160▲0◆80

Lente de 50° | Directa

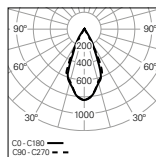

UGR	W	lm output	lm/W	mA	CÓDIGO*
≤13	9	1128	125	250	90578L0090▲0◆50
≤13	12	1512	126	350	90578L0160▲0◆50

Lente de 80° | Directa

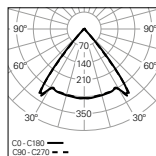

UGR	W	lm output	lm/W	mA	CÓDIGO*
≤25	9	1091	121	250	90578L0090▲0◆80
≤25	12	1428	119	350	90578L0160▲0◆80

6th ELEMENT +

- Para completar el producto es necesario pedir el cable/suspensión y la base de alimentación por separado.



*Sustituya los símbolos para completar el código

Color	◆
□ Blanco	W
■ Negro	B
■ Rusty chain	R

Temp. de color	◆
3000K	B
4000K	A

02. Seleccionar base de alimentación

Encastrar - T55 Q200

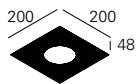

135x135

HF

	CÓDIGO*
10,5W 10-42V 250mA HF	972710♣
14,7W 10-42V 350mA HF	972711♣
21W 10-42V 500mA HF	972712♣

DALI

	CÓDIGO*
13W 09-52V 250mA DALI	972720♣
18,2W 09-52V 350mA DALI	972721♣
26W 09-52V 500mA DALI	972722♣

Superficie - T54 D120



HF

	CÓDIGO*
10W 30-42V 250mA HF	972730♣
15W 26-43V 350mA HF	972731♣
21W 30-42V 500mA HF	972732♣

DALI

	CÓDIGO*
12W 03-45V 250mA DALI	972740♣
16W 03-45V 350mA DALI	972741♣
20W 03-40V 500mA DALI	972742♣

BASE DE ALIMENTACIÓN

- Base de empotrar T55 Q200 de clase II.
- Base de superficie T54 D120 de clase I.
- Driver incluido en la base de techo.

03. Seleccionar opciones

OPCIONES	Código
Cable de alimentación / suspensión	
L1500 mm (x3)	942900
L3000 mm (x3)	942901
L6000 mm (x3)	942902



*Sustituya los símbolos para completar el código

Color	♣
□ Blanco	W
■ Negro	B
■ Rusty chain	R



Détail du produit



Efeito de luz com lentes de 50°



Efeito de luz com lentes de 80°

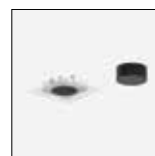

Base de techo



6th ELEMENT



Características del productos

Cuerpo

Aluminio inyectado



Acabado

Pintado en epoxi-poliéster



Sistema óptico

Lente



Fuente de luz

LED, RG1, CRI>90, MacAdam Step ≤3

Vida útil del LED

50.000h @ L80, B10, Ta 25°C

Fuente de alimentación

No incluida

01. Seleccionar versión

6th ELEMENT

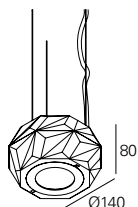

Lente de 50° | Directa / Indirecta (50%/50%)

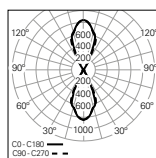

UGR	W	lm output	lm/W	mA	CÓDIGO*
≤10	17	2232	131	500	90280L0160▲0◆50

Lente de 80° | Directa / Indirecta (50%/50%)

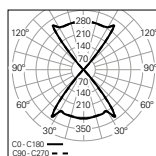

UGR	W	lm output	lm/W	mA	CÓDIGO*
≤19	17	2158	127	500	90280L0160▲0◆80

Lente de 50° | Direta

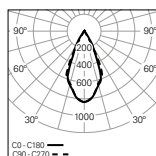

UGR	W	lm output	lm/W	mA	CÓDIGO*
≤13	9	1128	125	250	90328L0090▲0◆50
≤13	12	1512	126	350	90328L0160▲0◆50

Lente de 80° | Direta

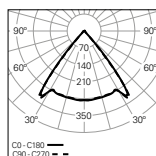

UGR	W	lm output	lm/W	mA	CÓDIGO*
≤25	9	1091	121	250	90328L0090▲0◆80
≤25	12	1428	119	350	90328L0160▲0◆80

6th ELEMENT

- Para completar el producto es necesario pedir la suspensión, el cable y la base de alimentación por separado.



*Sustituya los símbolos para completar el código

Color	◆
□ Blanco	W
■ Negro	B
■ Rusty chain	R

Temp. de color	◆
3000K	B
4000K	A

02. Seleccionar base de alimentación

Empotrar - T12 Q200

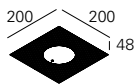

135x135

HF

	CÓDIGO*
10,5W 10-42V 250mA HF	971810♣
14,7W 10-42V 350mA HF	971811♣
21W 10-42V 500mA HF	971812♣

DALI

	CÓDIGO*
13W 09-52V 250mA DALI	971820♣
18,2W 09-52V 350mA DALI	971821♣
26W 09-52V 500mA DALI	971822♣

Superficie - T53 D120



HF

	CÓDIGO*
10W 30-42V 250mA HF	971830♣
15W 26-43V 350mA HF	971831♣
21W 30-42V 500mA HF	971832♣

DALI

	CÓDIGO*
12W 03-45V 250mA DALI	971840♣
16W 03-45V 350mA DALI	971841♣
20W 03-40V 500mA DALI	971842♣

BASE DE ALIMENTACIÓN

- Base de empotrar T12 Q200 de clase II.
- Base de superficie T53 D120 de clase I.
- Driver incluido en la base de techo.

03. Seleccionar opciones

OPCIONES	Código
Suspensión	
S14 L1500 mm (x3)	913300
S14 L3000 mm (x3)	913301
S14 L6000 mm (x3)	913302
Cable de alimentación	
L1500 mm - 2 x 0,75 mm ²	942800
L3000 mm - 2 x 0,75 mm ²	942801
L6000 mm - 2 x 0,75 mm ²	942802



*Sustituya los símbolos para completar el código

Color	♣
□ Blanco	W
■ Negro	B
■ Rusty chain	R



Détail du produit



Efeito de luz com lentes de 50°



Efeito de luz com lentes de 80°



Base de techo

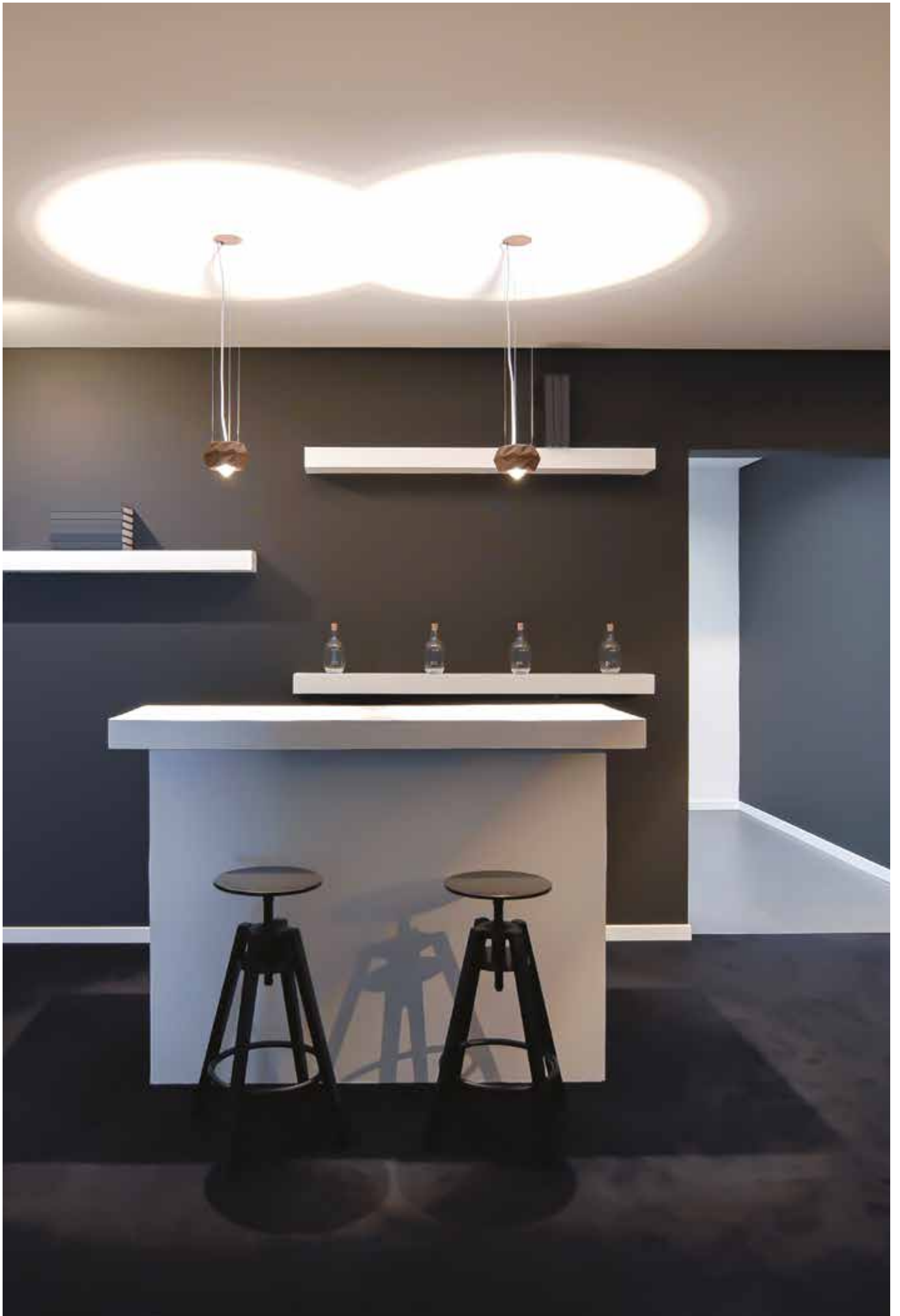

6th ELEMENT FIX



Características del productos

Cuerpo

Aluminio inyectado



Acabado

Pintado en epoxi-poliéster



Sistema óptico

Lente

Fuente de luz

LED, RG1, CRI>90, MacAdam Step ≤3



Vida útil del LED

50.000h @ L80, B10, Ta 25°C

Fuente de alimentación

No incluida

Espesor del techo

Para techos entre 10-25 mm

01. Seleccionar versión

6th ELEMENT FIX



Lente de 50°

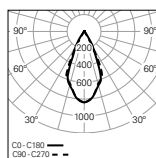

UGR	W	Im output	lm/W	mA	Ø	CÓDIGO*
≤13	9	1128	125	250	Ø125	90303L0090▲0♦50
≤13	12	1512	126	350	Ø125	90303L0160▲0♦50

Lente de 80°

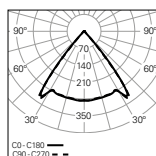

UGR	W	Im output	lm/W	mA	Ø	CÓDIGO*
≤25	9	1091	121	250	Ø125	90303L0090▲0♦80
≤25	12	1428	119	350	Ø125	90303L0160▲0♦80



*Sustituya los símbolos para completar el código

Color	Symbol
Blanco	W
Negro	B
Rusty chain	R

Temp. de color	Symbol
3000K	B
4000K	A

6th ELEMENT FIX

- Para completar el producto es necesario pedir la base de alimentación por separado.

02. Seleccionar opciones

OPCIONES Código

Fuente de alimentación HF	Código
Driver 10,5W 10-42V 250mA HF	900002E
Driver 14,7W 10-42V 350mA HF	900004E

Fuente de alimentación DALI	Código
Driver 13W 09-52V 250mA DALI+ PUSH	900102H
Driver 18,2W 09-52V 350mA DALI+ PUSH	900104H

Cable de seguridad en acero	Código
L1500 mm	955000



Détail du produit



Efecto de luz con lente de 50°

Efecto de luz con lente de 80°

Orientable de techo





**1. Rotación de 355°
y inclinación de 90°**

El producto permite una rotación
355° e inclinación de 90°,
lo que proporciona versatilidad
para iluminar objetos o zonas
específicas.



6th ELEMENT /C



Características del productos

Cuerpo

Aluminio inyectado



Acabado

Pintado en epoxi-poliéster



Sistema óptico

Lente



Fuente de luz

LED, RG1, CRI>90, MacAdam Step ≤3

Vida útil del LED

50.000h @ L80, B10, Ta 25°C



Fuente de alimentación

No incluida

01. Seleccionar versión

6th ELEMENT /C

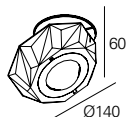

Lente de 50°

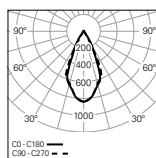

UGR	W	lm output	lm/W	mA	CÓDIGO*
≤13	9	1128	125	250	90278L0090▲0◆50
≤13	12	1512	126	350	90278L0160▲0◆50

Lente de 80°

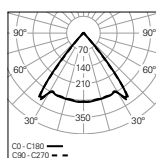

UGR	W	lm output	lm/W	mA	CÓDIGO*
≤25	9	1091	121	250	90278L0090▲0◆80
≤25	12	1428	119	350	90278L0160▲0◆80



*Sustituya los símbolos para completar el código

Color ▲
 Blanco W
 Negro B
 Rusty chain R

Temp. de color ◆
 3000K B
 4000K A

6th ELEMENT /C

- Para completar el producto es necesario pedir la base de alimentación por separado.

02. Seleccionar base de alimentación

Empotrar - T52 Q200



135x135

HF

	CÓDIGO*
10,5W 10-42V 250mA HF	972010♣
14,7W 10-42V 350mA HF	972011♣

DALI

	CÓDIGO*
13W 09-52V 250mA DALI	972020♣
18,2W 09-52V 350mA DALI	972021♣

Superficie - T51 D120



HF

	CÓDIGO*
10W 30-42V 250mA HF	972030♣
15W 26-43V 350mA HF	972031♣

DALI

	CÓDIGO*
12W 03-45V 250mA DALI	972040♣
16W 03-45V 350mA DALI	972041♣

BASE DE ALIMENTACIÓN

- Base de empotrar T52 Q200 de clase II.
- Base de superficie T51 D120 de clase I.
- Driver incluido en la base de techo.



*Sustituya los símbolos para completar el código

Color	♣
□ Blanco	W
■ Negro	B
■ Rusty chain	R



Détail du produit



Efecto de luz con lente de 50°



Efecto de luz con lente de 80°



Base de techo



Orientable de pared

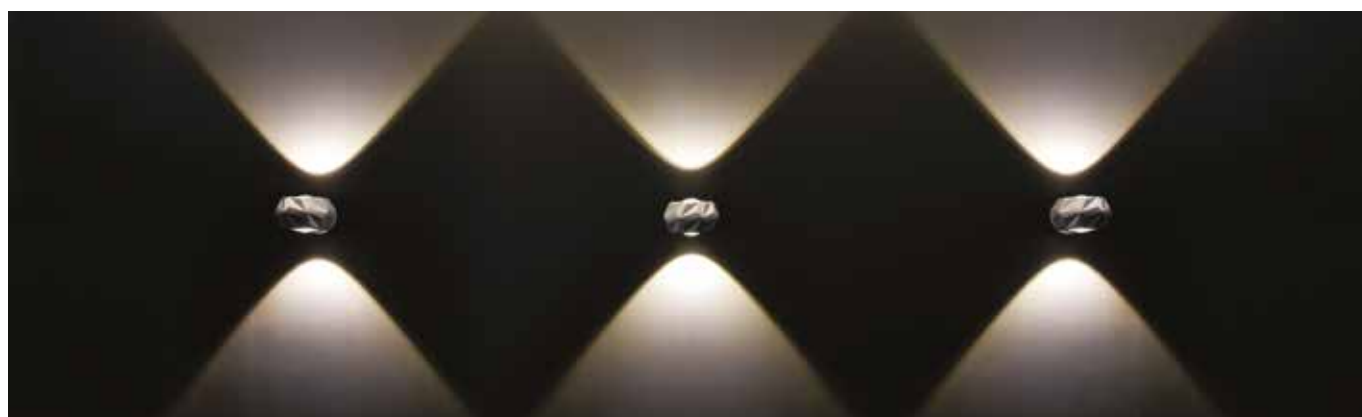
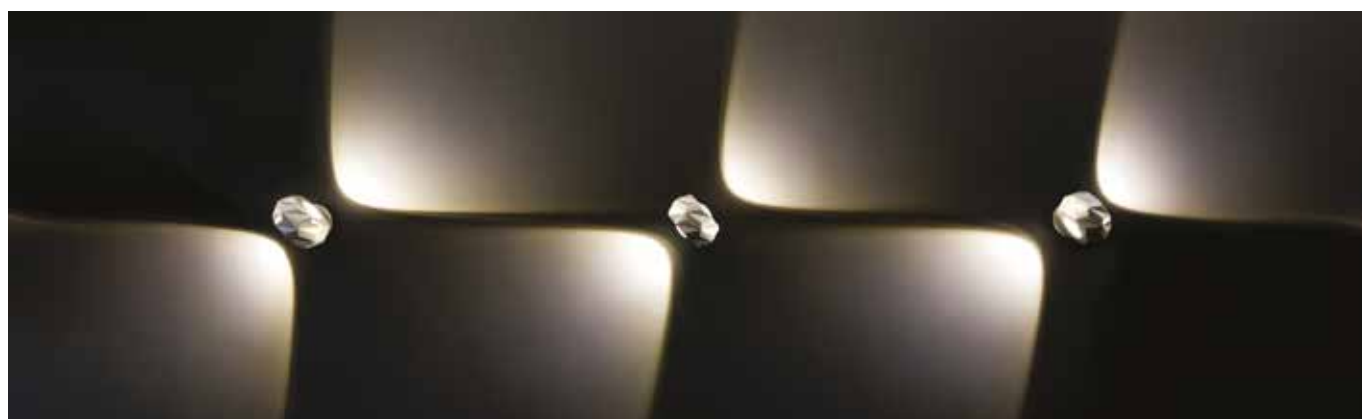

6th ELEMENT /W

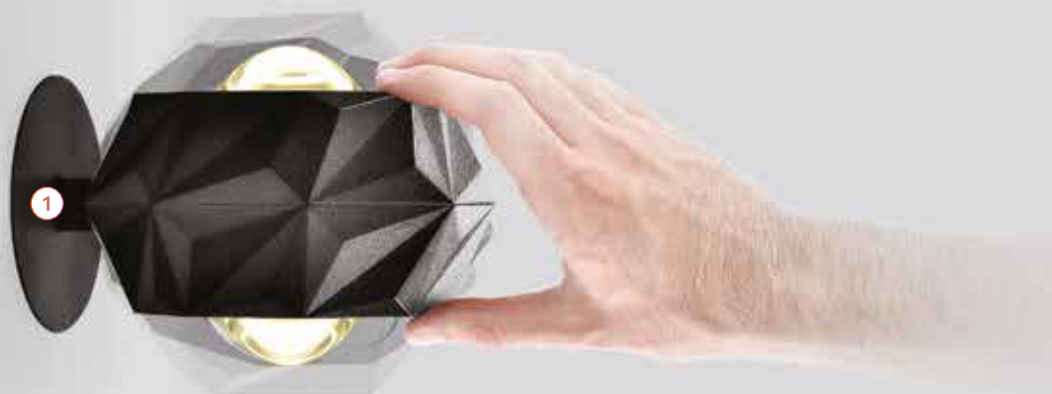

1. Rotación 355°

El producto permite una rotación de 355° que proporciona versatilidad para iluminar objetos o zonas específicas.



6th ELEMENT /W



Características del productos

Cuerpo

Aluminio inyectado



Acabado

Pintado en epoxi-poliéster



Sistema óptico

Lente



Fuente de luz

LED, RG1, CRI>90, MacAdam Step ≤3

Vida útil del LED

50.000h @ L80, B10, Ta 25°C

Fuente de alimentación

No incluida

01. Seleccionar versión

6th ELEMENT /W

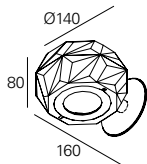

Lente de 50° | Directa / Indirecta (50%/50%)

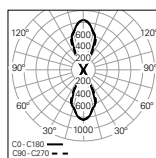

UGR	W	lm output	lm/W	mA	CÓDIGO*
≤10	17	2232	131	500	90279L0160▲0♦50

Lente de 80° | Directa / Indirecta (50%/50%)

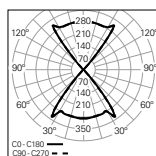

UGR	W	lm output	lm/W	mA	CÓDIGO*
≤19	17	2158	127	500	90279L0160▲0♦80

Lente de 50° | Directa

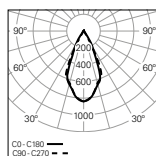

UGR	W	lm output	lm/W	mA	CÓDIGO*
≤13	9	1128	125	250	90330L0090▲0♦50
≤13	12	1512	126	350	90330L0160▲0♦50

Lente de 80° | Directa

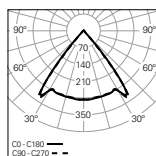

UGR	W	lm output	lm/W	mA	CÓDIGO*
≤25	9	1091	121	250	90330L0090▲0♦80
≤25	12	1428	119	350	90330L0160▲0♦80

6th ELEMENT /W

- Para completar el producto es necesario pedir la base de alimentación por separado.



*Sustituya los símbolos para completar el código

Color	◆
□ Blanco	W
■ Negro	B
■ Rusty chain	R

Temp. de color	◆
3000K	B
4000K	A

02. Seleccionar base de alimentación

Empotrar - T52 Q200

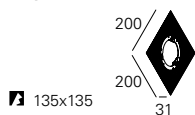

HF

	CÓDIGO*
10,5W 10-42V 250mA HF	972010♣
14,7W 10-42V 350mA HF	972011♣
21W 10-42V 500mA HF	972012♣

DALI

	CÓDIGO*
13W 09-52V 250mA DALI	972020♣
18,2W 09-52V 350mA DALI	972021♣
26W 09-52V 500mA DALI	972022♣

Superficie - T51 D120

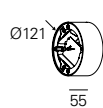

HF

	CÓDIGO*
10W 30-42V 250mA HF	972030♣
15W 26-43V 350mA HF	972031♣
21W 30-42V 500mA HF	972032♣

DALI

	CÓDIGO*
12W 03-45V 250mA DALI	972040♣
16W 03-45V 350mA DALI	972041♣
20W 03-40V 500mA DALI	972042♣



*Sustituya los símbolos para completar el código

Color	♣
□ Blanco	W
■ Negro	B
■ Rusty chain	R

BASE DE ALIMENTACIÓN

- Base de empotrar T52 Q200 de clase II.
- Base de superficie T51 D120 de clase I.
- Driver incluido en la base de techo.

Détail du produit



Efeito de luz com lentes de 50°



Efeito de luz com lentes de 80°



Base de superficie





NOAH



NOAH
62



NOAH /D
68



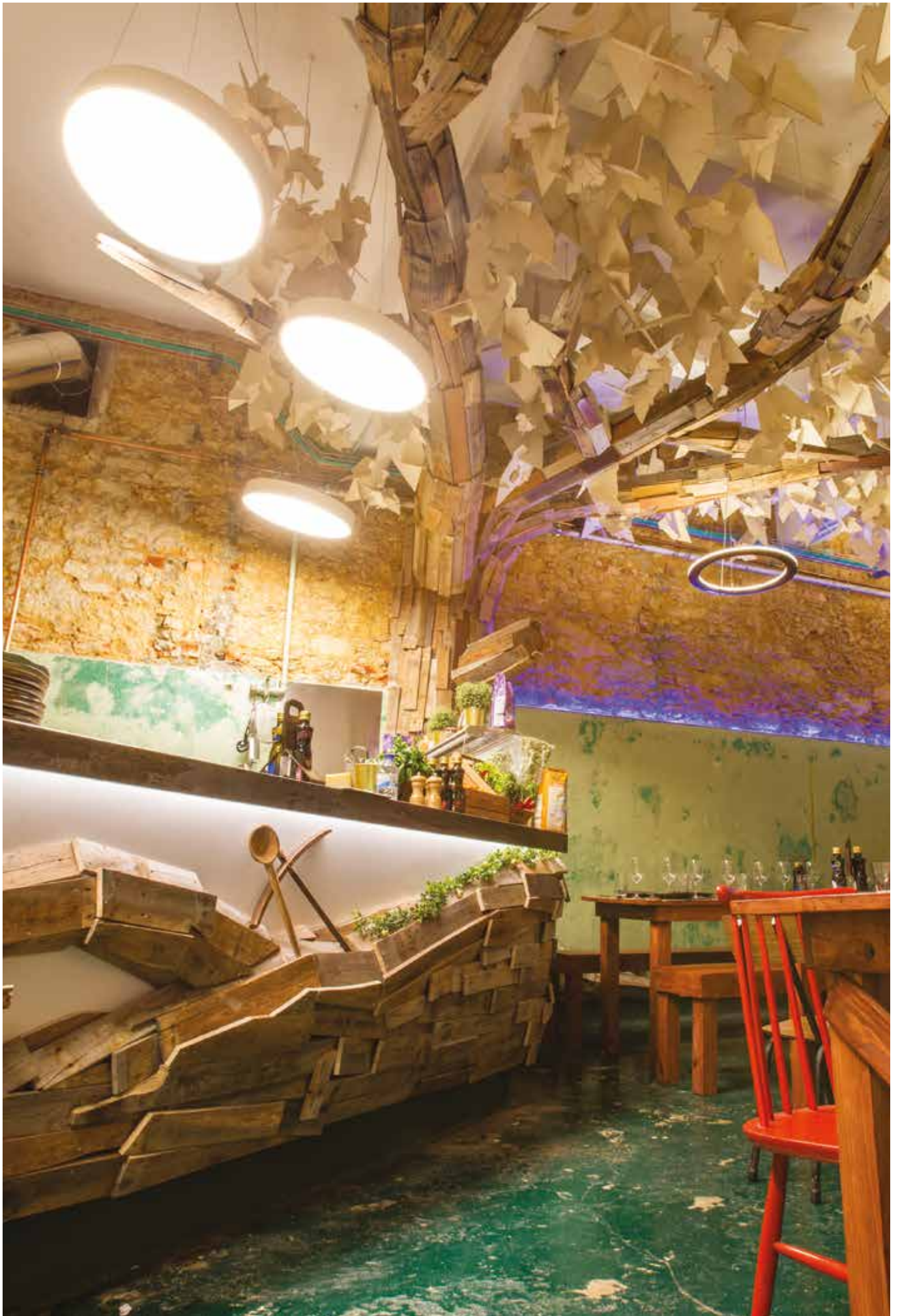



DAZ - Difusor opalino

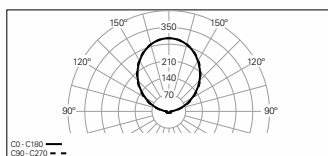

NOAH



Características del productos

Cuerpo

Madera



Acabado

Rosewood

230V/50Hz

Sistema óptico

DAZ - Difusor opalino



IP 40

Cablagem

Cable de alimentación transparente
con 1500 mm incluido

Fuente de luz

LED, RG1, CRI>80, MacAdam Step ≤3

650°C

Vida útil del LED

65.000h @ L90, B10, Ta 25°C

Fuente de alimentación

No incluida

01. Seleccionar versión



NOAH



DAZ - Difusor opalino

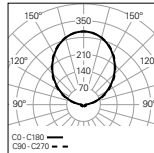

W
35

lm
output
5273

lm/W
135

CÓDIGO*
90061L0360J0♦00



*Sustituya los
símbolos para
completar el código

Temp. de color ♦
3000K 3
4000K 0

NOAH

- Para completar el producto es necesario añadir el driver. Por favor, solicítelo por separado.

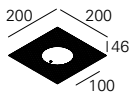
02. Seleccionar base de alimentación

Trimless		Superficie	
			
HF 130x135		HF	
Ø650	CÓDIGO* 974810♣	Ø650	CÓDIGO* 974910♣
DALI		DALI	
Ø650	CÓDIGO* 973010♣	Ø650	CÓDIGO* 973210♣
BLUETOOTH		BLUETOOTH	
Ø650	CÓDIGO* 972910♣	Ø650	CÓDIGO* 973110♣
BASE DE ALIMENTACIÓN • Driver incluido en la base de techo.			



*Sustituya los símbolos para completar el código

Color	
<input type="checkbox"/> Blanco	W
<input checked="" type="checkbox"/> Negro	B

03. Seleccionar opciones

OPCIONES	Código
Suspensión S10 L1500 mm (x3)	9111001



Détail du produit



Acabado Rosewood brillo



Aplicación suspendida



Difusor DAZ



Detalle de acabado



Base de techo de trimless



Base de techo de superficie



Luminaria orientable de mesa





1. Inclinable 20°

El producto es orientable y permite una inclinación de hasta 20° en todas las direcciones, lo que aporta versatilidad para dirigir la luz como desees.

2. Pulsador Touch Dim

El pulsador TouchDIM permite encender o apagar el producto e incluso ajustar la intensidad de la luz de forma fácil.



NOAH /D



Características del productos

Cuerpo

Base de acero
Parte superior en madera

Acabado

Base pintado en negro
Parte superior en Rosewood brillo

Sistema óptico

DAZ - Difusor opalino

Cablagem

Incluye cable de alimentación negro
con 1500 mm y enchufe tipo F

Fuente de luz

LED, RG1, CRI>90, MacAdam Step ≤3

Vida útil del LED

60.000h @ L80, B10, Ta 25°C

Fuente de alimentación

Incluye transformador 24V



01. Seleccionar versión



NOAH / D

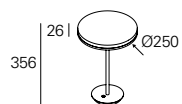

DAZ - Difusor opalino

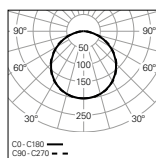

W
5

Im
output
307

Im/W
61

CÓDIGO*
90306L009HJ0♦00

*Sustituya los
símbolos para
completar el código

Temp. de color ♦
2700K 2
4000K 0

NOAH / D

- El producto estándar se suministra con un pulsador TouchDIM.



Détail
du produit



Acabado Rosewood
brillo



Pulsador Touch Dim



Ajustável



Enchufe tipo F

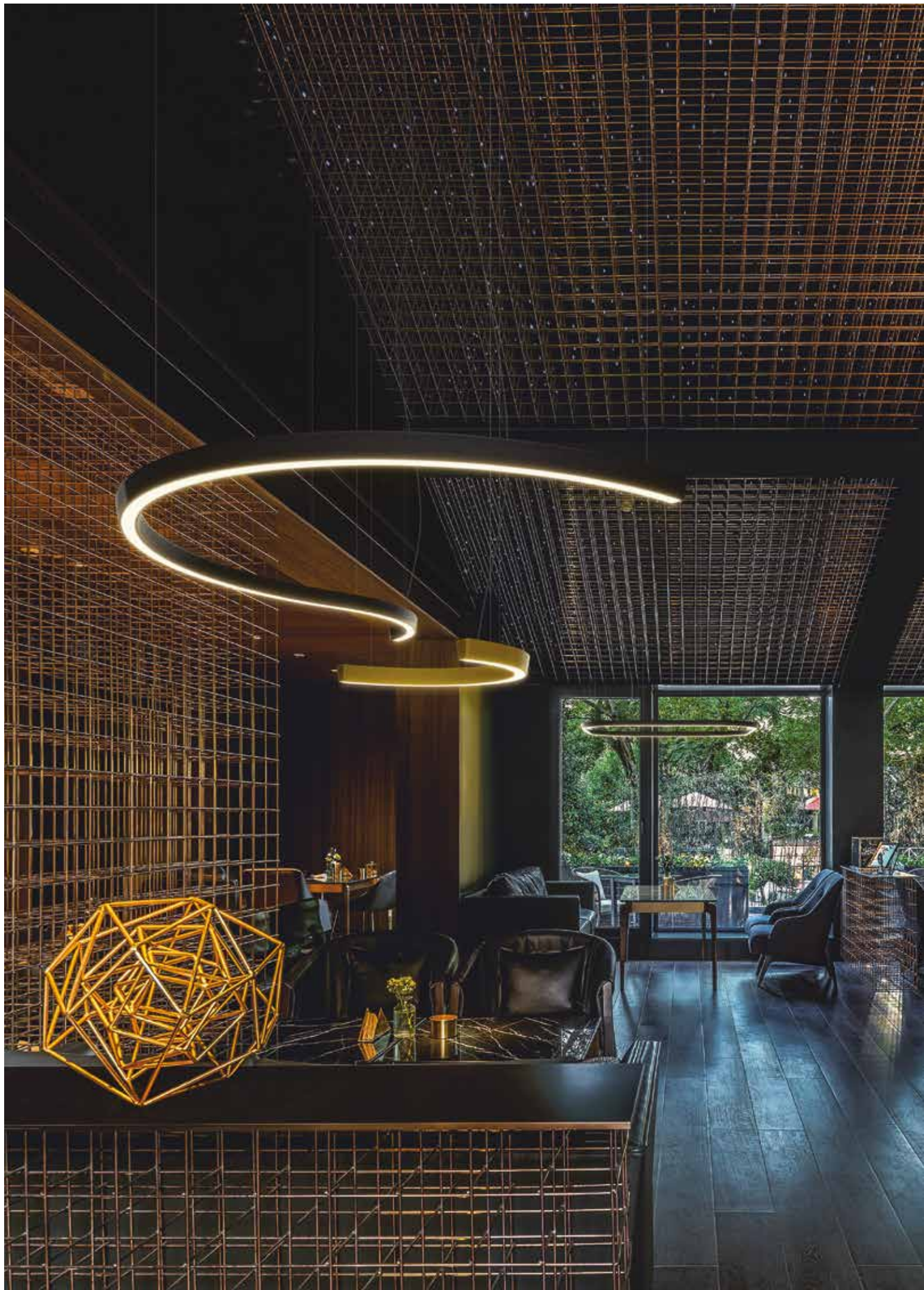

CONCEPT 35



CONCEPT S 35 / E
90



CONCEPT S 35
94



CONCEPT S 35 D/I
98



CONCEPT O 35 / E
104



CONCEPT O 35
106



CONCEPT O 35 D/I
110



CONCEPT Sq 35
114



CONCEPT Sq 35 D/I
118



CONCEPT D 35
122



CONCEPT D 35 D/I
126



Tipos de aplicación





1. Empotrado

2. Superficie

3. Suspendida
Directa

4. Suspendida
Directa / Indirecta

5. Pared

Un aspecto moderno para su espacio

1/16 (22,5°)



1/8 (45°)



1/4 (90°)



1/2 (180°)





LINEA

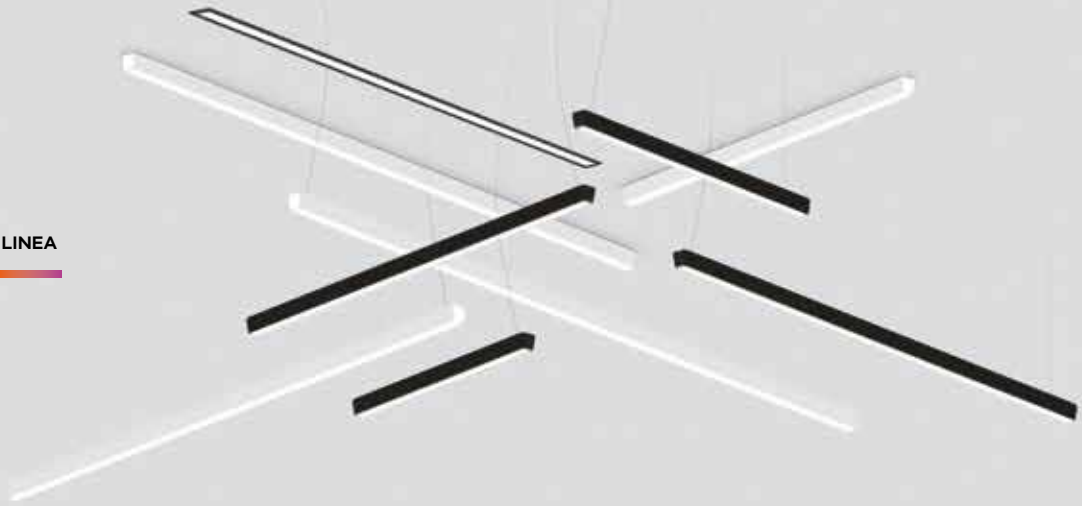

Cómo crear espacios a través de la luz

Ejemplo 1



Ejemplo 2



Ejemplo 3



Ejemplo 4





1. bFLEX

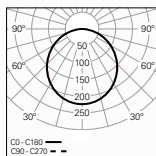

Minimalismo y tecnología

1. Cuerpo

Perfil de aluminio soldado sin marcas, disponible en 12 colores.

2. LED

SDCM MacAdam ≤ 3 , temperatura de color 3000K / 4000K, CRI > 80 y vida útil de 60.000h L90 B10.

3. bFLEX

Difusor de alta tecnología en versión opalina (bFLEX) que garantiza una luz suave y uniforme sin puntos visibles. Difusor especial disponible en rollo individual de hasta 5000, 15000 o 30000 mm.



4. Tapas

Tapas de aluminio inyectado, sin salidas de luz y sin tornillos visibles. Disponibles en el color del producto.

5. HPR

Reflector interno de alto rendimiento para garantizar una alta eficiencia y una luz suave y uniforme.

6. Luz indirecta

Versión directa / indirecta con 80% / 20% de proporción de luz y difusor opalino para uniformidad de la luz en el techo.

7. Fuente de alimentación DALI ou HF

SwitchDIM bajo consulta.

8. Suspensión y cable de alimentación

Suspensiones y cable de alimentación disponibles en longitudes de 1500, 3000 o 6000 mm.

9. Base de alimentación

Bases empotradas o de superficie. Disponibles en blanco o negro.



10. Kit de unión

Los extremos de los módulos están fabricados de tal forma que no hay salida de luz, sea en versión curva o recta.

El kit de unión incluye un conector rápido para la parte eléctrica que garantiza una instalación rápida y sencilla.

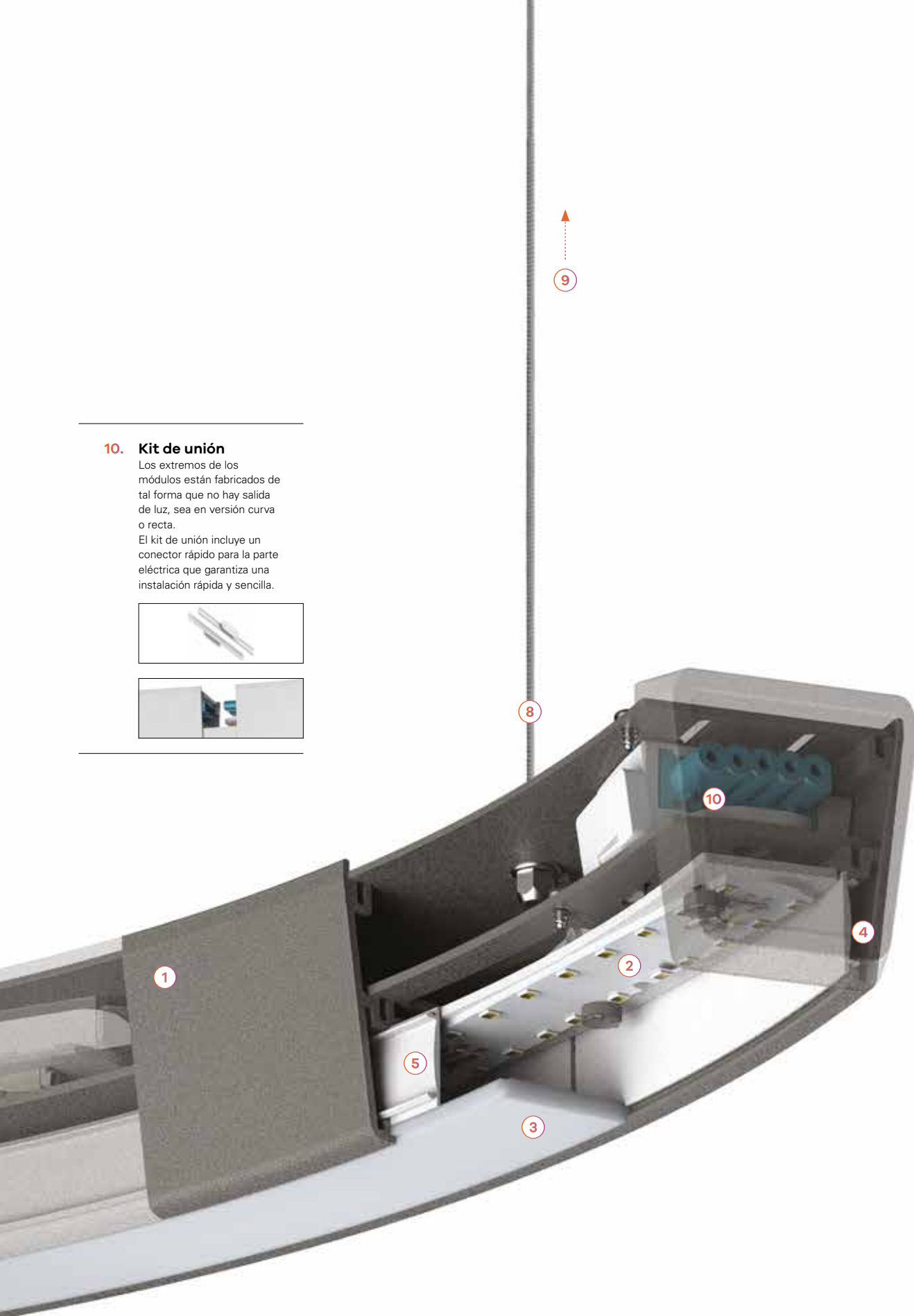

Composición de los elementos estructurales

Cómo montar una línea

(Vista desde arriba)

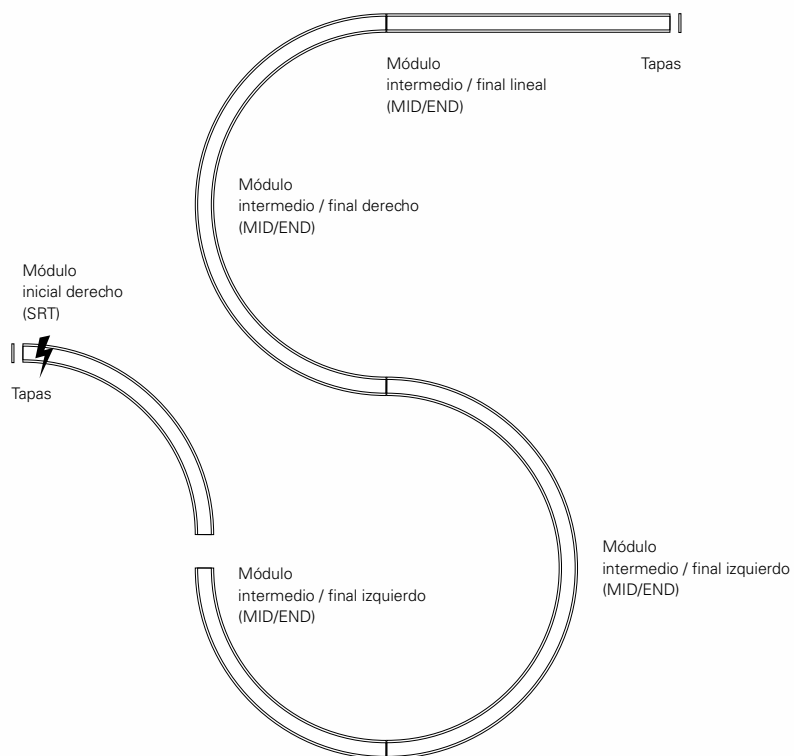

Módulos disponibles

(Vista desde arriba)

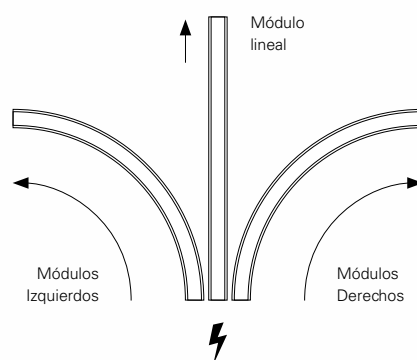

1. Tapas

2. Módulos LED

- 2.1 Módulo inicial (SRT)
 - 2.2 Módulo intermedio / final (MID/END).
-

3. Kit de unión

4. Base de techo

5. Cable de alimentación

6. Suspensión

Empotrar

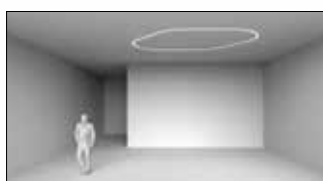

Suspendida, superficie o pared

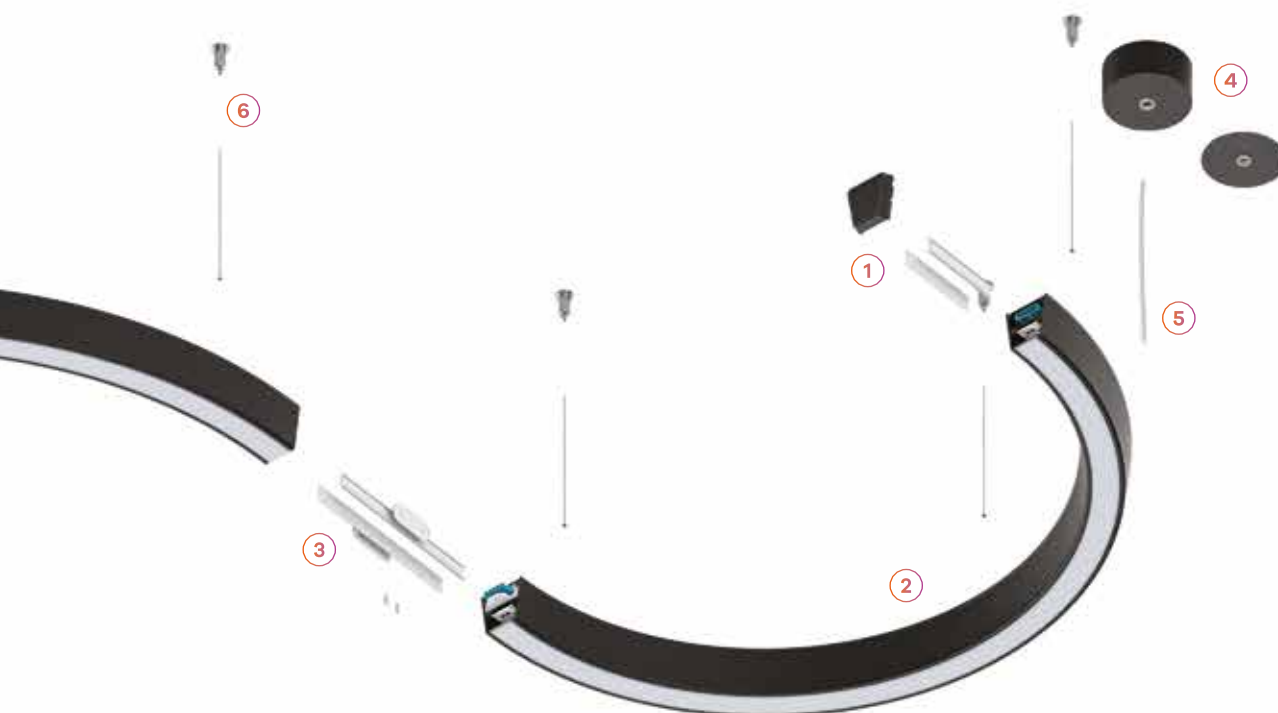

Una gama de posibilidades infinita

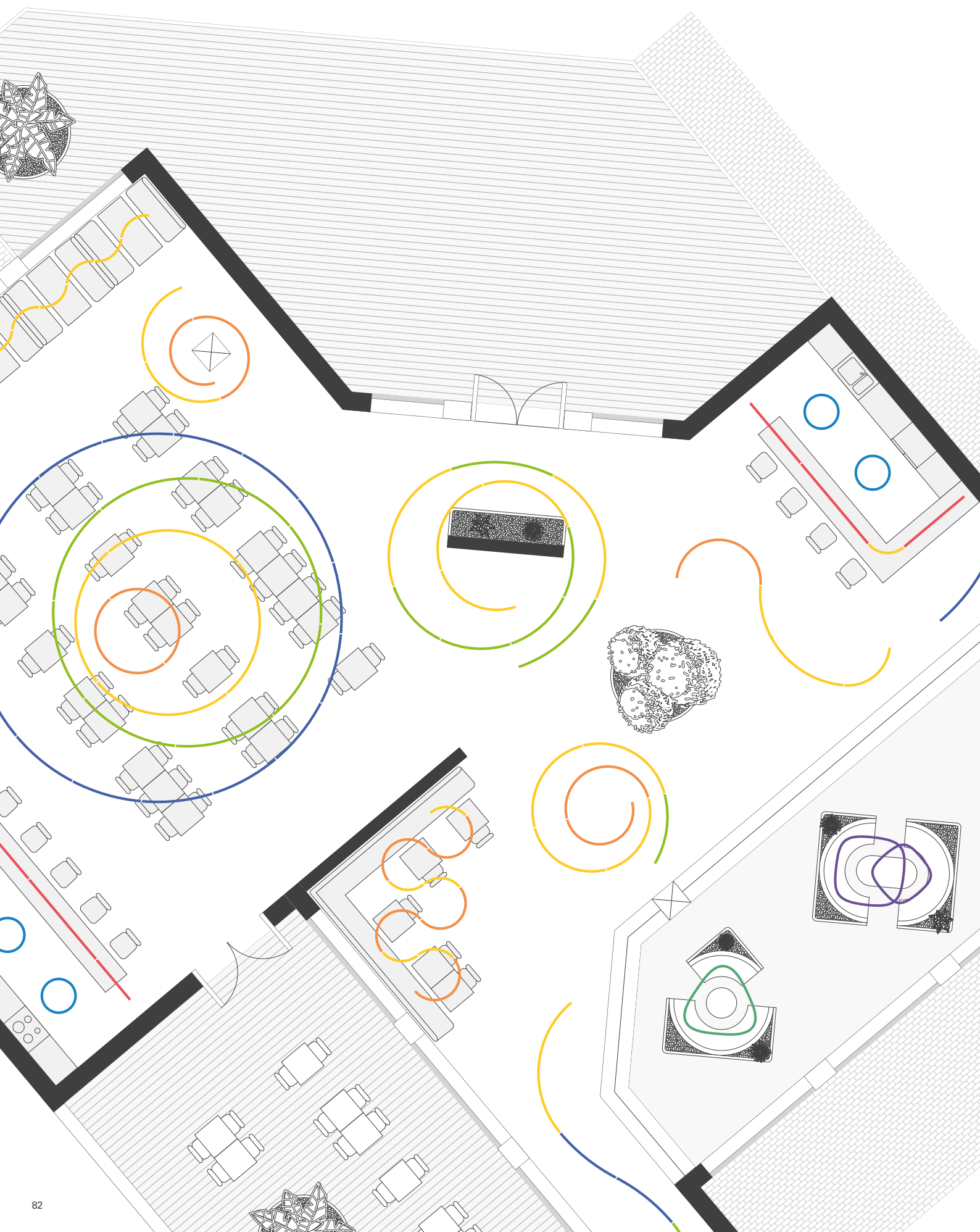

LINEA 1/16 (22,5°) 1/8 (45°) 1/4 (90°) 1/2 (180°) 1/1 (360°)



≈843 mm	•				
≈1124 mm	•				
≈1405 mm	•				
≈1686 mm	•				
≈1967 mm	•				
≈2248 mm	•				
≈2529 mm	•				
≈2810 mm	•				
≈Ø455 mm					•
≈Ø777 mm				•	•
≈Ø1136 mm			•	•	•
≈Ø1494 mm			•	•	•
≈Ø1853 mm		•	•	•	
≈Ø2569 mm		•	•		
≈Ø2926 mm		•	•		
≈Ø4000 mm		•	•		
≈Ø5789 mm		•			
≈Ø7936 mm		•			



≈1126 mm		•
≈1187 mm	•	
≈1441 mm		•
≈1465 mm	•	

Módulos
disponibles

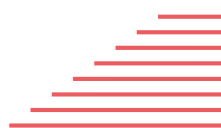

Escala 1:100 1000 mm

Defina su color

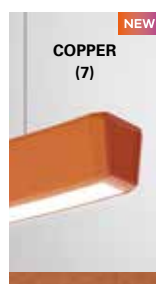
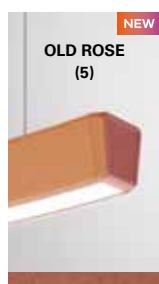
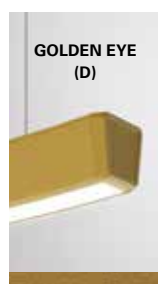
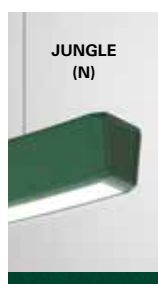
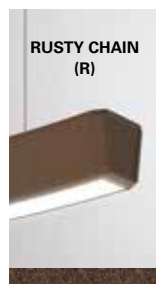
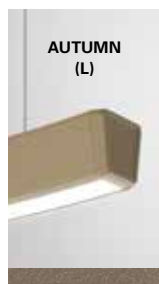
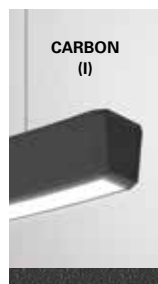
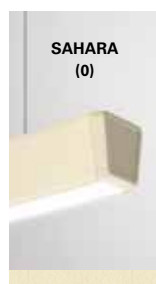
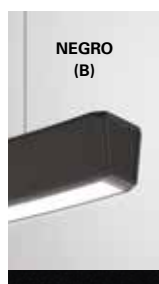
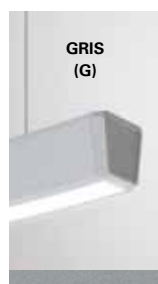

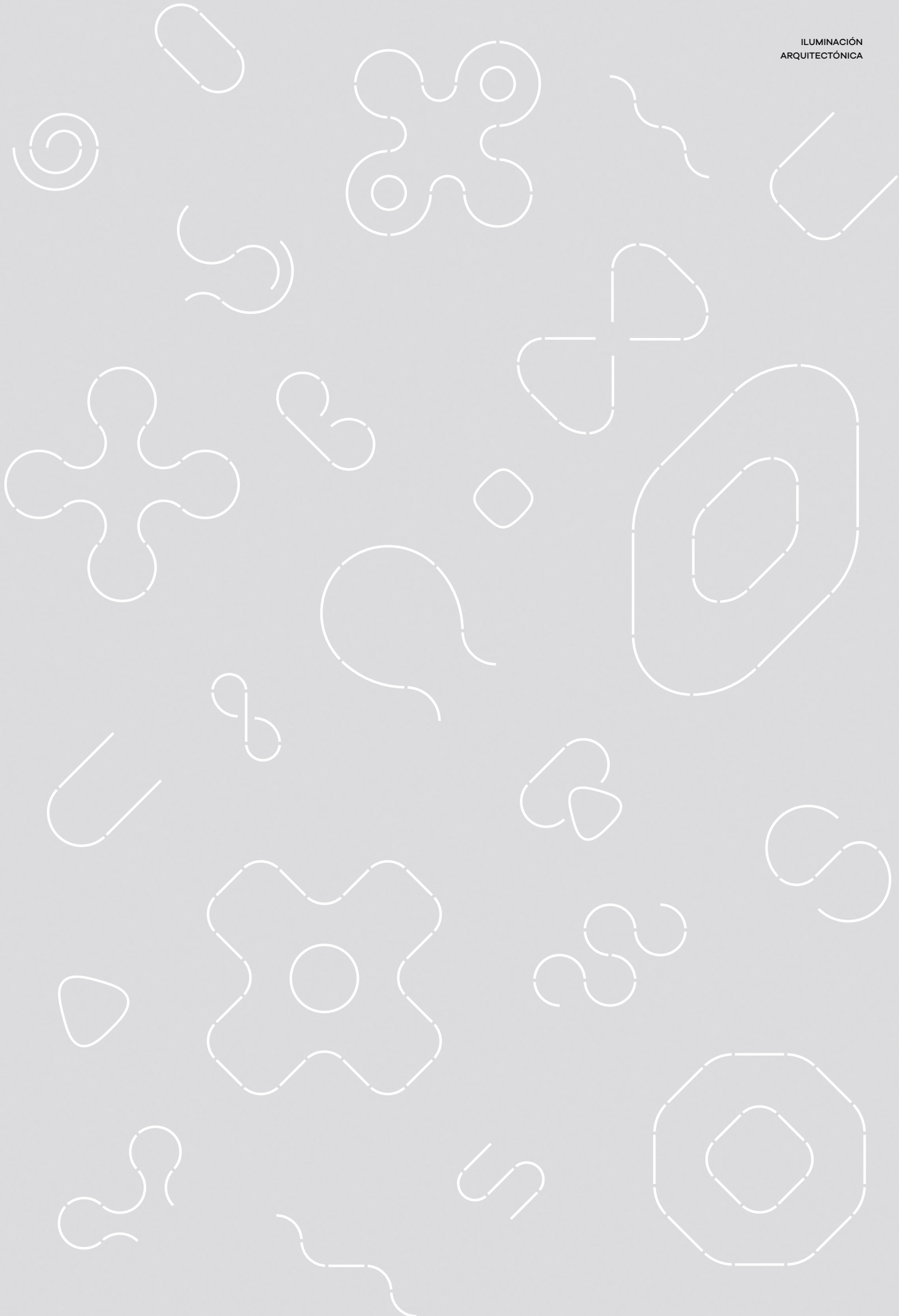

Diseño y elegancia



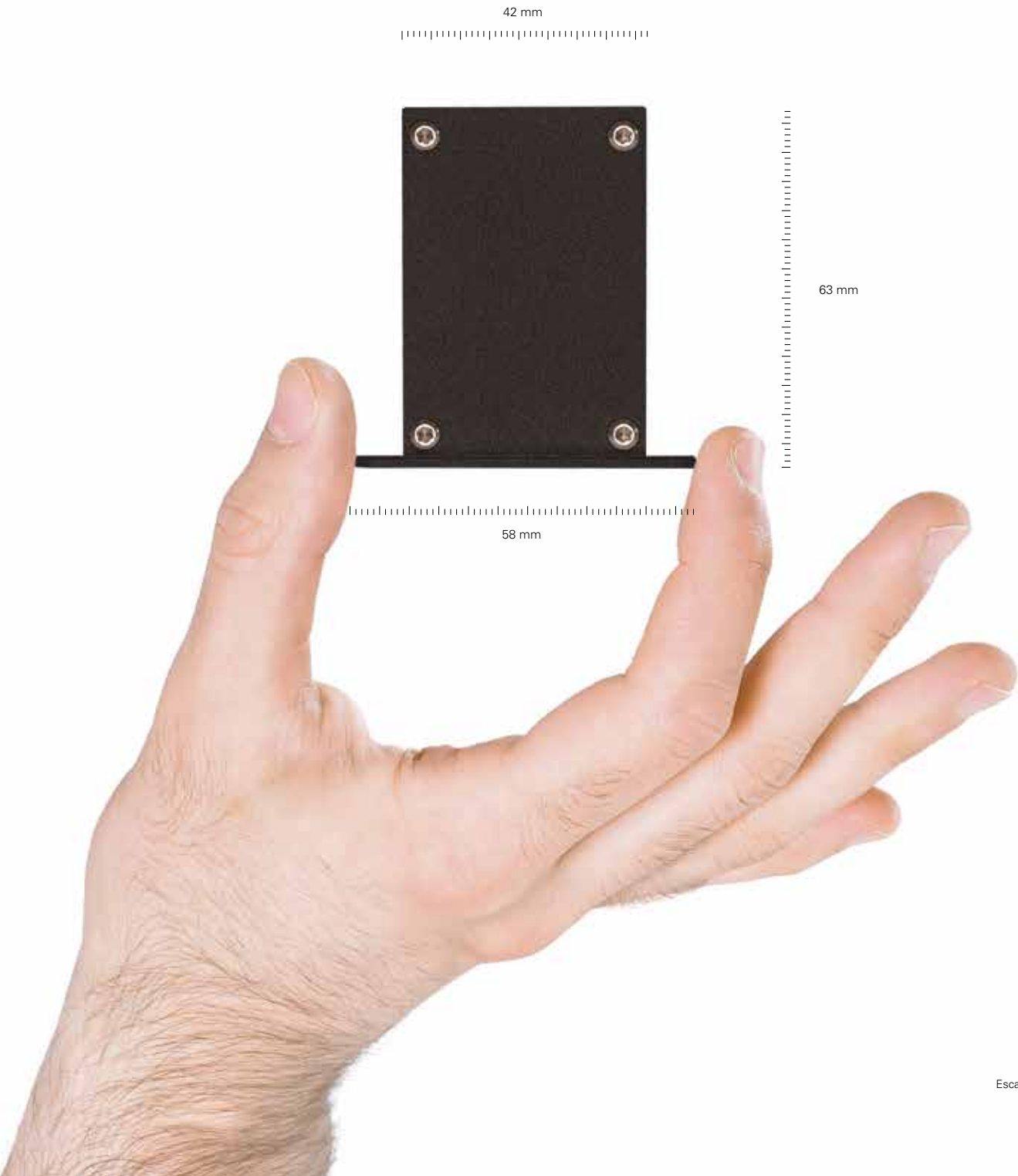

¡Créalo tú mismo!



Configurador

Descubra nuestro configurador de la gama CONCEPT 35 y cree su propio diseño de iluminación de forma más rápida e inteligente!

configurator.indelaguegroup.com



CONCEPT S 35 /E



Características del productos

Cuerpo

Aluminio



Acabado

Pintado en epoxi-poliéster

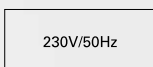

Sistema óptico

bFLEX - Difusor opalino no incluido



Cablagem

Incluye cableado de línea continua



Fuente de luz

LED, RG1, CRI>80, MacAdam Step ≤3

Vida útil del LED

70.000h @ L90, B10, Ta 25°C

Fuente de alimentación

Driver LED 220-240V-50/60Hz incluido

Espesor del techo

Para techos entre 1-25 mm

01. Seleccionar módulo



MÓDULO CURVO

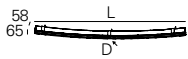

1/16 (22,5°) | bFLEX - Difusor opalino (no incluido)

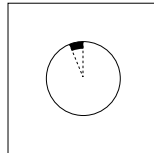

W	Im output	Im/W	Lmm	Dmm	CÓDIGO*
49	4539	93	1549	Ø7939	90710▲011▼▲0♣♣



1/8 (45°) | bFLEX - Difusor opalino (no incluido)

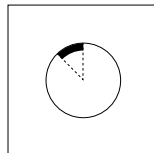

W	Im output	Im/W	Lmm	Dmm	CÓDIGO*
24	2063	86	710	Ø1856	90711▲005▼▲0♣♣
32	2889	90	984	Ø2572	90711▲007▼▲0♣♣
36	3301	92	1121	Ø2929	90711▲008▼▲0♣♣
49	4539	93	1532	Ø4003	90711▲011▼▲0♣♣
68	6602	97	2217	Ø5792	90711▲016▼▲0♣♣

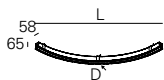

1/4 (90°) | bFLEX - Difusor opalino (no incluido)

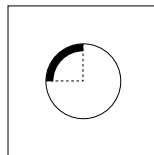

W	Im output	Im/W	Lmm	Dmm	CÓDIGO*
28	2476	88	805	Ø1139	90712▲006▼▲0♣♣
36	3301	92	1059	Ø1497	90712▲008▼▲0♣♣
44	4127	94	1312	Ø1856	90712▲010▼▲0♣♣
61	5777	95	1818	Ø2572	90712▲014▼▲0♣♣
68	6602	97	2071	Ø2929	90712▲016▼▲0♣♣
90	9078	101	2831	Ø4003	90712▲022▼▲0♣♣

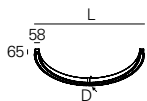

1/2 (180°) | bFLEX - Difusor opalino (no incluido)

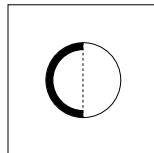

W	Im output	Im/W	Lmm	Dmm	CÓDIGO*
36	3301	92	780	Ø780	90713▲008▼▲0♣♣
53	4952	93	1139	Ø1139	90713▲012▼▲0♣♣
68	6602	97	1497	Ø1497	90713▲016▼▲0♣♣
83	8253	99	1856	Ø1856	90713▲020▼▲0♣♣

*Sustituya los símbolos para completar el código

Orientación	▲
LEFT	L
RIGHT	R

Fuente de alimentación	▼
HF	E
DALI	H

Color ¹	♣
Blanco	W
Gris	G
Negro	B
Sahara	0
Mist	1
Carbon	I
Autumn	L
Rusty chain	R
Jungle	N
Golden eye	D
Old rose	5
Copper	7

Temp. de color	♦
3000K	3
4000K	0

Módulo	♣
SRT	49
MID/END	98

MÓDULO LINEAL

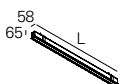

LINEA | bFLEX - Difusor opalino (no incluido)

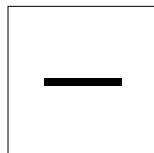

W	Im output	Im/W	Lmm	CÓDIGO*
28	2476	88	843	90709L006▼▲0♣♣
36	3301	92	1124	90709L008▼▲0♣♣
44	4127	94	1405	90709L010▼▲0♣♣
53	4952	93	1686	90709L012▼▲0♣♣
61	5777	95	1967	90709L014▼▲0♣♣
68	6602	97	2248	90709L016▼▲0♣♣
76	7428	98	2529	90709L018▼▲0♣♣
83	8253	99	2810	90709L020▼▲0♣♣

MÓDULO CURVO | MÓDULO LINEAL

- Para completar el producto individual es necesario añadir difusor bFLEX y Start Kit. Por favor solicítelo por separado.
- Para completar una línea, es necesario un difusor bFLEX, Start Kit y kit de unión. Por favor solicítelo por separado.
- Las dimensiones no incluyen Start Kit. Para completar la dimensión empotrada de la línea, incremente 6 mm a la longitud de corte.
- Para las dimensiones de corte, consulte las instrucciones de montaje del producto o en nuestro sitio web.

02. Seleccionar opciones

OPCIONES	Código*
Difusor bFLEX	
L5000 mm	985705
L15000 mm	985715
L30000 mm	985730
SwitchDIM	
• Mediante solicitud.	
Start kit - Tapas inicio/final	923010♣
• Incluye dos tapas y tornillos.	
Kit de unión (x1)	932010
• Tornillos incluidos.	
Kit de unión VRT 90° (x1)	932020
• Tornillos incluidos.	
Cable de seguridad en acero	
L1500 mm	955000
Kit de marcado	
• Mediante solicitud.	



*Sustituya los símbolos para completar el código

Color ¹	
□ Blanco	W
■ Gris	G
■ Negro	B
■ Sahara	0
■ Mist	1
■ Carbon	I
■ Autumn	L
■ Rusty chain	R
■ Jungle	N
■ Golden eye	D
■ Old rose	5
■ Copper	7



Détail du produit

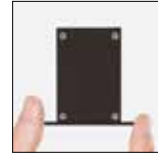

Tapa

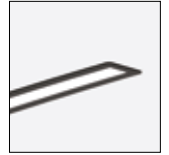

Aplicación de empotrar



Difusor continuo



Difusor bFLEX



Difusor aplicado



CONCEPT S 35



Características del productos

Cuerpo

Aluminio



Acabado

Pintado en epoxi-poliéster

230V/50Hz

Sistema óptico

bFLEX - Difusor opalino no incluido



IP 40

Cablagem

Incluye cableado de línea continua

Fuente de luz

LED, RG1, CRI>80, MacAdam Step ≤3



Vida útil del LED

70.000h @ L90, B10, Ta 25°C

Fuente de alimentación

Driver LED 220-240V-50/60Hz incluido

01. Seleccionar módulo



MÓDULO CURVO

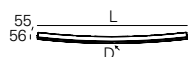

1/16 (22,5°) | bFLEX - Difusor opalino (no incluido)

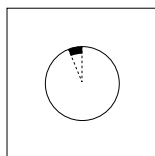

W	Im output	Im/W	Lmm	Dmm	CÓDIGO*
49	4539	93	1548	Ø7936	90543▲011▼▲0♣♣

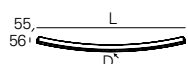

1/8 (45°) | bFLEX - Difusor opalino (no incluido)

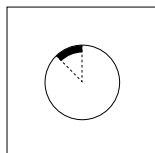

W	Im output	Im/W	Lmm	Dmm	CÓDIGO*
24	2063	86	709	Ø1853	90544▲005▼▲0♣♣
32	2889	90	983	Ø2569	90544▲007▼▲0♣♣
36	3301	92	1120	Ø2926	90544▲008▼▲0♣♣
49	4539	93	1531	Ø4000	90544▲011▼▲0♣♣
68	6602	97	2215	Ø5789	90544▲016▼▲0♣♣



1/4 (90°) | bFLEX - Difusor opalino (no incluido)

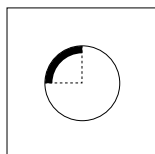

W	Im output	Im/W	Lmm	Dmm	CÓDIGO*
28	2476	88	803	Ø1136	90545▲006▼▲0♣♣
36	3301	92	1057	Ø1494	90545▲008▼▲0♣♣
44	4127	94	1310	Ø1853	90545▲010▼▲0♣♣
61	5777	95	1816	Ø2569	90545▲014▼▲0♣♣
68	6602	97	2069	Ø2926	90545▲016▼▲0♣♣
90	9078	101	2828	Ø4000	90545▲022▼▲0♣♣

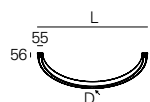

1/2 (180°) | bFLEX - Difusor opalino (no incluido)

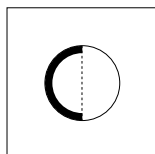

W	Im output	Im/W	Lmm	Dmm	CÓDIGO*
36	3301	92	777	Ø777	90546▲008▼▲0♣♣
53	4952	93	1136	Ø1136	90546▲012▼▲0♣♣
68	6602	97	1494	Ø1494	90546▲016▼▲0♣♣
83	8253	99	1853	Ø1853	90546▲020▼▲0♣♣

*Sustituya los símbolos para completar el código

Orientación	▲
LEFT	L
RIGHT	R

Fuente de alimentación	▼
HF	E
DALI	H

Color ¹	♣
Blanco	W
Gris	G
Negro	B
Sahara	0
Mist	1
Carbon	I
Autumn	L
Rusty chain	R
Jungle	N
Golden eye	D
Old rose	5
Copper	7

Temp. de color	♦
3000K	3
4000K	0

Módulo	♣
SRT	49
MID/END	98

MÓDULO LINEAL

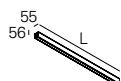

LINEA | bFLEX - Difusor opalino (no incluido)

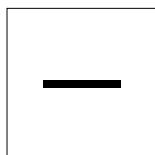

W	Im output	Im/W	Lmm	CÓDIGO*
28	2476	88	843	90541L006▼▲0♣♣
36	3301	92	1124	90541L008▼▲0♣♣
44	4127	94	1405	90541L010▼▲0♣♣
53	4952	93	1686	90541L012▼▲0♣♣
61	5777	95	1967	90541L014▼▲0♣♣
68	6602	97	2248	90541L016▼▲0♣♣
76	7428	98	2529	90541L018▼▲0♣♣
83	8253	99	2810	90541L020▼▲0♣♣

MÓDULO CURVO | MÓDULO LINEAL

- Para completar el producto individual es necesario añadir difusor bFLEX y Start Kit. Por favor solicítelo por separado.
- Para completar una línea, es necesario un difusor bFLEX, Start Kit y kit de unión. Por favor solicítelo por separado.
- Para la versión suspendida, es necesario pedir suspensiones, cable y base de alimentación por separado.
- Las dimensiones no incluyen el start kit. Incremente 26 mm para completar la línea.
- Para ayudarle en la configuración del producto, por favor consulte CONFIGURATOR.INDELAGEGROUP.COM.

02. Seleccionar opciones

OPCIONES	Código*
Difusor bFLEX	
L5000 mm	985705
L15000 mm	985715
L30000 mm	985730
SwitchDIM	
• Mediante solicitud.	
Start kit - Tapas inicio/final 923000♣	
• Dos tapas finales incluidas.	
Kit de unión (x1) 932000	
• Tornillos incluidos.	
Suspensión	
• Para todas las versiones curvas y rectas L1967, L2248, L2529, L2810 mm:	
S11 L1500 mm (x3)	9129031
S11 L3000 mm (x3)	9129032
S11 L6000 mm (x3)	9129033
• Para versiones línea L843, L1124, L1405, L1686 mm:	
S11 L1500 mm (x2)	9129021
S11 L3000 mm (x2)	9129022
S11 L6000 mm (x2)	9129023
Cable de alimentación transparente	
L1500 mm - 3 x 1,5 mm ²	940300
L1500 mm - 5 x 1,5 mm ²	940000
L3000 mm - 3 x 1,5 mm ²	940301
L3000 mm - 5 x 1,5 mm ²	940001
L6000 mm - 3 x 1,5 mm ²	940302
L6000 mm - 5 x 1,5 mm ²	940002
Base circular ¹	
Superficie T24 D95 45 Ø95	978600♣
Empotrar T5 D90 Ø70 33 Ø90	971300♣
Kit de marcado	
• Mediante solicitud.	



*Sustituya los símbolos para completar el código

Color ^{1 2}	♣
□ Blanco	W
■ Gris	G
■ Negro	B
■ Sahara	0
■ Mist	1
■ Carbon	I
■ Autumn	L
■ Rusty chain	R
■ Jungle	N
■ Golden eye	D
■ Old rose	5
■ Copper	7



Détail du produit



Tapas sin tornillos visibles



Aplicación de superficie



Aplicación suspendida



Conexión rápida



Difusor continuo



Difusor bFLEX



Difusor aplicado



Start kit



Kit de unión



Base de techo

¹ Bases de techo solo están disponibles en blanco o negro.

² Ver página 84.



CONCEPT S 35 D/I



Características del producto

Cuerpo

Aluminio

**Acabado**

Pintado en epoxi-poliéster

230V/50Hz

Sistema óptico

bFLEX - Difusor opalino no incluido



IP 40

Cablagem

Incluye cableado de línea continua

Fuente de luz

LED, RG1, CRI>80, MacAdam Step ≤ 3

**Vida útil del LED**

70.000h @ L90, B10, Ta 25°C

Fuente de alimentación

Driver LED 220-240V-50/60Hz incluido

01. Seleccionar módulo



MÓDULO CURVO

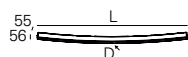

1/16 (22,5°) | bFLEX - Difusor opalino (no incluido) (80%/20%)

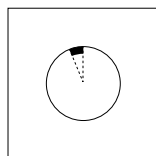

W	lm output	lm/W	Lmm	Dmm	CÓDIGO*
61	5777	95	1548	Ø7936	90547▲011▼▲0◆♣

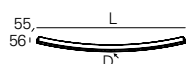

1/8 (45°) | bFLEX - Difusor opalino (no incluido) (80%/20%)

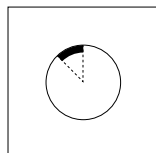

W	lm output	lm/W	Lmm	Dmm	CÓDIGO*
44	4127	94	1120	Ø2926	90548▲008▼▲0◆♣
61	5777	95	1531	Ø4000	90548▲011▼▲0◆♣
83	8253	99	2215	Ø5789	90548▲016▼▲0◆♣



1/4 (90°) | bFLEX - Difusor opalino (no incluido) (80%/20%)

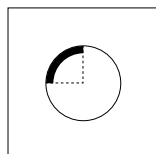

W	lm output	lm/W	Lmm	Dmm	CÓDIGO*
44	4127	94	1057	Ø1494	90549▲008▼▲0◆♣
57	5364	94	1310	Ø1853	90549▲010▼▲0◆♣
76	7428	98	1816	Ø2568	90549▲014▼▲0◆♣
83	8253	99	2069	Ø2926	90549▲016▼▲0◆♣
122	11554	95	2828	Ø4000	90549▲022▼▲0◆♣

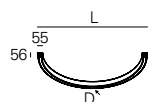

1/2 (180°) | bFLEX - Difusor opalino (no incluido) (80%/20%)

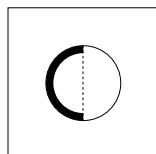

W	lm output	lm/W	Lmm	Dmm	CÓDIGO*
44	4127	94	777	Ø777	90550▲008▼▲0◆♣
64	6190	97	1136	Ø1136	90550▲012▼▲0◆♣
83	8253	99	1494	Ø1494	90550▲016▼▲0◆♣
110	10316	94	1853	Ø1853	90550▲020▼▲0◆♣

MÓDULO LINEAL

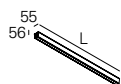

LINEA | bFLEX - Difusor opalino (no incluido) (80%/20%)

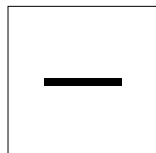

W	lm output	lm/W	Lmm	CÓDIGO*
44	4127	94	1124	90542L008▼▲0◆♣
57	5364	94	1405	90542L010▼▲0◆♣
64	6190	97	1686	90542L012▼▲0◆♣
76	7428	98	1967	90542L014▼▲0◆♣
83	8253	99	2248	90542L016▼▲0◆♣
94	9491	101	2529	90542L018▼▲0◆♣
110	10316	94	2810	90542L020▼▲0◆♣

MÓDULO CURVO | MÓDULO LINEAL

- Para completar el producto es necesario pedir el difusor bFLEX, start kit, suspensión, cable y la base de alimentación por separado.
- Para completar la línea es necesario pedir el difusor bFLEX, start kit, kit de unión, suspensión, cable y la base de alimentación por separado.
- Las dimensiones no incluyen el start kit. Incremente 26 mm para completar la línea.
- Para garantizar una uniformidad total de la luz en el techo, la instalación debe realizarse con una distancia mínima de 500 mm.
- Para ayudarle en la configuración del producto, por favor consulte CONFIGURATOR.INDELAGUEGROUP.COM.

*Sustituya los símbolos para completar el código

Orientación	▲
LEFT	L
RIGHT	R

Fuente de alimentación	▼
HF	E
DALI	H

Color ¹	♣
Blanco	W
Gris	G
Negro	B
Sahara	0
Mist	1
Carbon	I
Autumn	L
Rusty chain	R
Jungle	N
Golden eye	D
Old rose	5
Copper	7

Temp. de color	◆
3000K	3
4000K	0

Módulo	♣
SRT	49
MID/END	98

¹ Ver página 84.

02. Seleccionar opciones

OPCIONES	Código*
Difusor bFLEX	
L5000 mm	985705
L15000 mm	985715
L30000 mm	985730
SwitchDIM	
• Mediante solicitud.	
Start kit - Tapas inicio/final	
• Dos tapas finales incluidas.	55 923000♣ 56 13 35
Kit de unión (x1)	
• Tornillos incluidos.	932000
Suspensión	
• Para todas las versiones curvas y rectas L1967, L2248, L2529, L2810 mm:	
S11 L1500 mm (x3)	9129031
S11 L3000 mm (x3)	9129032
S11 L6000 mm (x3)	9129033
• Para versiones línea L843, L1124, L1405, L1686 mm:	
S11 L1500 mm (x2)	9129021
S11 L3000 mm (x2)	9129022
S11 L6000 mm (x2)	9129023
Cable de alimentación transparente	
L1500 mm - 3 x 1,5 mm ²	940300
L1500 mm - 5 x 1,5 mm ²	940000
L3000 mm - 3 x 1,5 mm ²	940301
L3000 mm - 5 x 1,5 mm ²	940001
L6000 mm - 3 x 1,5 mm ²	940302
L6000 mm - 5 x 1,5 mm ²	940002
Base circular¹	
Superficie T24 D95	45 Ø95 978600♣
Empotrar T5 D90	Ø70 33 Ø90 971300♣
Kit de marcado	
• Mediante solicitud.	



*Sustituya los símbolos para completar el código

Color ^{1,2}	♣
□ Blanco	W
■ Gris	G
■ Negro	B
■ Sahara	0
■ Mist	1
■ Carbon	I
■ Autumn	L
■ Rusty chain	R
■ Jungle	N
■ Golden eye	D
■ Old rose	5
■ Copper	7



Détail du produit



Tapas sin tornillos visibles



Aplicación suspendida



Conexión rápida



Difusor continuo



Luz indirecta



Difusor bFLEX



Difusor aplicado



Start kit



Kit de unión



Base de techo

¹ Bases de techo solo están disponibles en blanco o negro.

² Ver página 84.



Composición de los elementos estructurales



Módulos disponibles

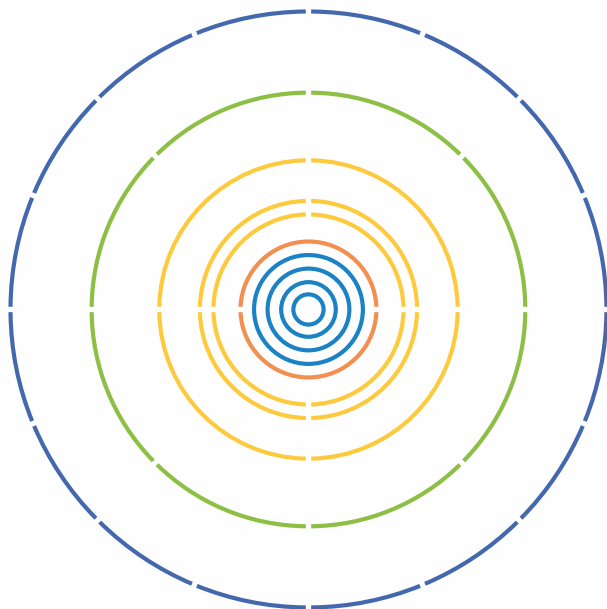

INDIVIDUAL (módulo único)

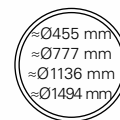

COMPUESTO (varios módulos)



Nº DE
MÓDULOS

VERSIÓN DE
MÓDULOS

Nº DE
SUSPENSIONES

Díámetro

≈Ø455 mm	1	1/1 (360°)	3
≈Ø777 mm	1	1/1 (360°)	3
≈Ø1136 mm	1	1/1 (360°)	4
≈Ø1494 mm	1	1/1 (360°)	6
≈Ø1853 mm	2	1/2 (180°)	6
≈Ø2569 mm	4	1/4 (90°)	8
≈Ø2926 mm	4	1/4 (90°)	12
≈Ø4000 mm	4	1/4 (90°)	12
≈Ø5789 mm	8	1/8 (45°)	24
≈Ø7936 mm	16	1/16 (22,5°)	32

Escala 1:100
1000 mm



1. Musgo acústico

El musgo acústico puede transformar el ambiente de su habitación.

Tiene excelentes propiedades de aislamiento acústico y regulación de la humedad, lo que contribuye a disminuir el ruido y mejorar el ambiente laboral.



2. Panel acústico

El panel acústico tiene una excelente absorción acústica, aumentando el confort y bienestar de quienes trabajan o viven en los espacios. Disponible en una variedad de colores, perfecto para combinar con cualquier ambiente.



CONCEPT O 35 /E



Características del productos

Cuerpo

Aluminio



Acabado

Pintado en epoxi-poliéster

230V/50Hz

Sistema óptico

bFLEX - Difusor opalino



Fuente de luz

LED, RG1, CRI>80, MacAdam Step ≤3

Vida útil del LED

70.000h @ L90, B10, Ta 25°C



Fuente de alimentación

Driver LED 220-240V-50/60Hz incluido

Espesor del techo

Para techos entre 1-25 mm

01. Seleccionar versión

CONCEPT O 35 /E



bFLEX - Difusor opalino

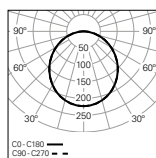

W	lm output	lm/W	Dmm	CÓDIGO*
36	3296	92	Ø458	90708L012
68	6602	97	Ø780	90708L016
97	9904	102	Ø1139	90708L024
136	13205	97	Ø1497	90708L032
166	16506	99	Ø1856	90708L040
244	23108	95	Ø2572	90708L056
272	26410	97	Ø2929	90708L064
360	36313	101	Ø4003	90708L088
544	52819	97	Ø5792	90708L128
784	72626	93	Ø7939	90708L176

CONCEPT O 35 /E

- Para diámetros superiores a Ø1497 mm el producto se compone de varios módulos.
- Para dimensiones de corte, consulte las instrucciones de montaje del producto o en nuestro sitio web.



*Sustituya los símbolos para completar el código

Fuente de alimentación ▼
 HF E
 DALI H

Color † ▲

□ Blanco	W
■ Gris	G
■ Negro	B
■ Sahara	0
■ Mist	1
■ Carbon	I
■ Autumn	L
■ Rusty chain	R
■ Jungle	N
■ Golden eye	D
■ Old rose	5
■ Copper	7

Temp. de color ◆

3000K	3
4000K	0

02. Seleccionar opciones



Détail du produit

OPCIONES Código

SwitchDIM

- Mediante solicitud.

Cable de seguridad en acero

L1500 mm 955000

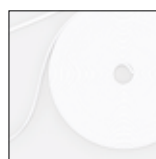

Difusor bFLEX

† Ver página 84.

CONCEPT O 35



Características del productos

Cuerpo

Aluminio

Acabado

Pintado en epoxi-poliéster

Sistema óptico

bFLEX - Difusor opalino

Fuente de luz

LED, RG1, CRI>80, MacAdam Step ≤3

Vida útil del LED

70.000h @ L90, B10, Ta 25°C

Fuente de alimentación

Driver LED 220-240V-50/60Hz incluido



230V/50Hz



IP 40



01. Seleccionar versión



CONCEPT O 35

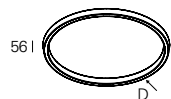

bFLEX - Difusor opalino

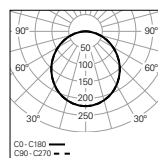

W	lm output	lm/W	Dmm	CÓDIGO*
36	3296	92	Ø455	90539L012▼▲◆00
68	6602	97	Ø777	90539L016▼▲◆00
97	9904	102	Ø1136	90539L024▼▲◆00
136	13205	97	Ø1494	90539L032▼▲◆00
166	16506	99	Ø1853	90539L040▼▲◆00
244	23108	95	Ø2569	90539L056▼▲◆00
272	26410	97	Ø2926	90539L064▼▲◆00
360	36313	101	Ø4000	90539L088▼▲◆00
544	52819	97	Ø5789	90539L128▼▲◆00
784	72626	93	Ø7936	90539L176▼▲◆00

*Sustituya los símbolos para completar el código

Fuente de alimentación ▼

HF E

DALI H

Color † ▲

□ Blanco W

■ Gris G

■ Negro B

■ Sahara 0

■ Mist 1

■ Carbon I

■ Autumn L

■ Rusty chain R

■ Jungle N

■ Golden eye D

■ Old rose 5

■ Copper 7

CONCEPT O 35

- Para la versión suspendida, es necesario pedir suspensiones, cable y base de alimentación por separado.
- Para diámetros superiores a Ø1494 mm el producto se compone de varios módulos.
- Para ayudarle en la configuración del producto, por favor consulte CONFIGURATOR.INDELAGUEGROUP.COM.

Temp. de color ◆

3000K 3

4000K 0

02. Seleccionar opciones

OPCIONES	Código*
SwitchDIM	
• Mediante solicitud.	
Suspensión	
S11 (x3) - Ø455, Ø777 mm	912903▲
S11 (x4) - Ø1136 mm	912904▲
S11 (x6) - Ø1494, Ø1853 mm	912906▲
S11 (x8) - Ø2569 mm	912908▲
S11 (x12) - Ø2926, Ø4000 mm	912912▲
S11 (x24) - Ø5789 mm	912924▲
S11 (x32) - Ø7936 mm	912932▲
Cable de alimentación transparente	
L1500 mm - 3 x 0,75 mm ²	940400
L1500 mm - 5 x 0,75 mm ²	940500
L3000 mm - 3 x 0,75 mm ²	940401
L3000 mm - 5 x 0,75 mm ²	940501
L6000 mm - 3 x 0,75 mm ²	940402
L6000 mm - 5 x 0,75 mm ²	940507
Base circular	
Superficie T24 D95  45 l Ø95	978600▲
Empotrar T5 D90  Ø70 33 l Ø90	971300▲
Base de techo central	
Superficie T20 3l - Ø455, Ø777 mm	977201▲
Superficie T20 4l - Ø1136 mm	977202▲
Superficie T20 6l - Ø1494 mm  45 l Ø95	977204▲
Musgo acústico	
Ø455 mm	926800
Ø777 mm	926801
Ø1136 mm	926802
• Absorción acústica y control de la humedad.	
• Otros diámetros mediante solicitud.	
Panel acústico	
Ø455 mm	926900
Ø777 mm	926901
Ø1136 mm	926902
• Absorción acústica.	
• Otros diámetros mediante solicitud.	



*Sustituya los símbolos para completar el código

Longitud	▲
L1500 mm	1
L3000 mm	2
L6000 mm	3

Color	▲
<input type="checkbox"/> Blanco	W
<input checked="" type="checkbox"/> Negro	B



Détail du produit



Difusor bFLEX



Base de techo



Musgo acústico



Musgo acústico (macro)



Panel acústico



Panel acústico (macro)



CONCEPT O 35 D/I



Características del productos

Cuerpo

Aluminio



Acabado

Pintado en epoxi-poliéster

230V/50Hz

Sistema óptico

bFLEX - Difusor opalino



IP 40

Fuente de luz

LED, RG1, CRI>80, MacAdam Step ≤ 3

Vida útil del LED

70.000h @ L90, B10, Ta 25°C



Fuente de alimentación

Driver LED 220-240V-50/60Hz incluido

01. Seleccionar versión

CONCEPT O 35 D/I

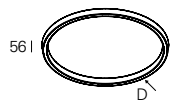

bFLEX - Difusor opalino (80%/20%)

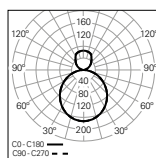

W	lm output	lm/W	Dmm	CÓDIGO*
83	8253	99	Ø777	90540L016▼▲◆00
128	12380	97	Ø1136	90540L024▼▲◆00
166	16506	99	Ø1494	90540L032▼▲◆00
220	20633	94	Ø1853	90540L040▼▲◆00
304	29711	98	Ø2569	90540L056▼▲◆00
332	33012	99	Ø2926	90540L064▼▲◆00
488	46217	95	Ø4000	90540L088▼▲◆00
664	66024	99	Ø5789	90540L128▼▲◆00
976	92434	95	Ø7936	90540L176▼▲◆00

CONCEPT O 35 D/I

- Para completar el producto es necesario pedir la suspensión, el cable y la base de alimentación por separado.
- Para diámetros superiores a Ø1494 mm el producto se compone de varios módulos.
- Para garantizar una uniformidad total de la luz en el techo, la instalación debe realizarse con una distancia mínima de 500 mm.
- Para ayudarle en la configuración del producto, por favor consulte CONFIGURATOR.INDELAGUEGROUP.COM.



*Sustituya los símbolos para completar el código



Fuente de alimentación	
HF	E
DALI	H

Color ¹	
□ Blanco	W
■ Gris	G
■ Negro	B
■ Sahara	0
■ Mist	1
■ Carbon	I
■ Autumn	L
■ Rusty chain	R
■ Jungle	N
■ Golden eye	D
■ Old rose	5
■ Copper	7

Temp. de color	
3000K	3
4000K	0

¹ Ver página 84.

02. Seleccionar opciones

OPCIONES	Código*
SwitchDIM	
• Mediante solicitud.	
Suspensión	
S11 (x3) - Ø777 mm	912903▲
S11 (x4) - Ø1136 mm	912904▲
S11 (x6) - Ø1494, Ø1853 mm	912906▲
S11 (x8) - Ø2569 mm	912908▲
S11 (x12) - Ø2926, Ø4000 mm	912912▲
S11 (x24) - Ø5789 mm	912924▲
S11 (x32) - Ø7936 mm	912932▲
Cable de alimentación transparente	
L1500 mm - 3 x 0,75 mm ²	940400
L1500 mm - 5 x 0,75 mm ²	940500
L3000 mm - 3 x 0,75 mm ²	940401
L3000 mm - 5 x 0,75 mm ²	940501
L6000 mm - 3 x 0,75 mm ²	940402
L6000 mm - 5 x 0,75 mm ²	940507
Base circular	
Superficie T24 D95  45 l Ø95	978600▲
Empotrar T5 D90  Ø70 33 l Ø90	971300▲
Base de techo central	
Superficie T20 3l - Ø777 mm	977201▲
Superficie T20 4l - Ø1136 mm	977202▲
Superficie T20 6l - Ø1494 mm  45 l Ø95	977204▲
Musgo acústico	
Ø777 mm	926801
Ø1136 mm	926802
• Absorción acústica y control de la humedad.	
• Otros diámetros mediante solicitud.	
Panel acústico	
Ø777 mm	926901
Ø1136 mm	926902
• Absorción acústica.	
• Otros diámetros mediante solicitud.	



*Sustituya los símbolos para completar el código

Longitud	▲
L1500 mm	1
L3000 mm	2
L6000 mm	3

Color	▲
<input type="checkbox"/> Blanco	W
<input checked="" type="checkbox"/> Negro	B



Détail du produit



Luz indirecta



Difusor bFLEX



Musgo acústico



Musgo acústico (macro)



Panel acústico



Panel acústico (macro)



Base de techo



CONCEPT Sq 35



Características del productos

Cuerpo

Aluminio

Acabado

Pintado en epoxi-poliéster

Sistema óptico

bFLEX - Difusor opalino

Fuente de luz

LED, RG1, CRI>80, MacAdam Step ≤3

Vida útil del LED

70.000h @ L90, B10, Ta 25°C

Fuente de alimentación

Driver LED 220-240V-50/60Hz incluido



230V/50Hz



IP 40

bFLEX
960°C

01. Seleccionar versión

CONCEPT Sq 35

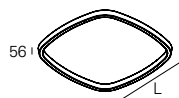

bFLEX - Difusor opalino

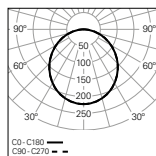

W	lm output	lm/W	Lmm	CÓDIGO*
112	10450	93	1126	90704L027▼▲◆00
140	13752	98	1441	90704L033▼▲◆00

CONCEPT Sq 35

• Para la versión suspendida, es necesario pedir suspensiones, cable y base de alimentación por separado.



*Sustituya los símbolos para completar el código





Fuente de alimentación	▼
HF	E
DALI	H

Color ¹	▲
Blanco	W
Gris	G
Negro	B
Sahara	0
Mist	1
Carbon	I
Autumn	L
Rusty chain	R
Jungle	N
Golden eye	D
Old rose	5
Copper	7

Temp. de color	◆
3000K	3
4000K	0

¹ Ver página 84.

02. Seleccionar opciones

OPCIONES	Código*
SwitchDIM	
• Mediante solicitud.	
Suspensión	
S11 L1500 mm (x4)	9129041
S11 L3000 mm (x4)	9129042
S11 L6000 mm (x4)	9129043
Cable de alimentación transparente	
L1500 mm - 3 x 0,75 mm ²	940400
L1500 mm - 5 x 0,75 mm ²	940500
L3000 mm - 3 x 0,75 mm ²	940401
L3000 mm - 5 x 0,75 mm ²	940501
L6000 mm - 3 x 0,75 mm ²	940402
L6000 mm - 5 x 0,75 mm ²	940507
Base circular	
Superficie T24 D95  Ø95	45 978600▲
Empotrar T5 D90  Ø70 33  Ø90	971300▲
Base de techo central	
Superficie T20 4l  Ø95	45 977202▲



*Sustituya los símbolos para completar el código

Color

<input type="checkbox"/> Blanco	W
<input checked="" type="checkbox"/> Negro	B



Détail du produit



Difusor bFLEX



Base de techo

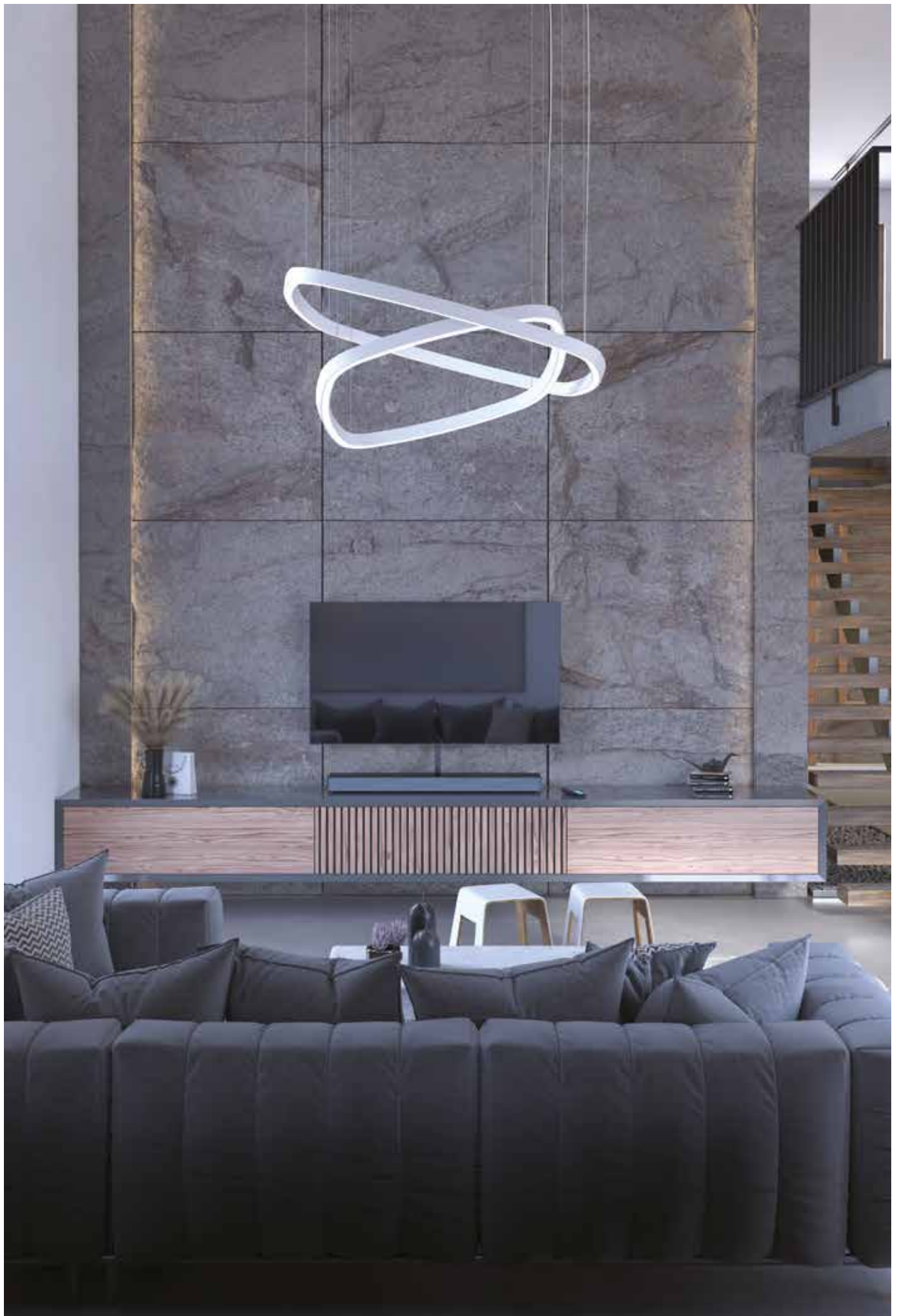

CONCEPT Sq 35 D/I



Características del productos

Cuerpo

Aluminio



Acabado

Pintado en epoxi-poliéster

230V/50Hz

Sistema óptico

bFLEX - Difusor opalino



IP 40

Fuente de luz

LED, RG1, CRI>80, MacAdam Step ≤3

Vida útil del LED

70.000h @ L90, B10, Ta 25°C



Fuente de alimentación

Driver LED 220-240V-50/60Hz incluido

01. Seleccionar versión



CONCEPT Sq 35 D/I

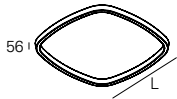

bFLEX - Difusor opalino (80%/20%)

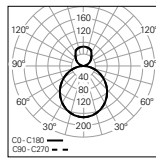

W	lm output	lm/W	Lmm	CÓDIGO*
140	13752	98	1126	90705L027▼▲◆0◆00
170	17053	100	1441	90705L033▼▲◆0◆00

*Sustituya los símbolos para completar el código

Fuente de alimentación ▼

HF	E
DALI	H

Color ¹ ▲

□ Blanco	W
■ Gris	G
■ Negro	B
■ Sahara	0
■ Mist	1
■ Carbon	I
■ Autumn	L
■ Rusty chain	R
■ Jungle	N
■ Golden eye	D
■ Old rose	5
■ Copper	7

CONCEPT Sq 35 D/I





- Para completar el producto es necesario pedir la suspensión, el cable y la base de alimentación por separado.
- Para garantizar una uniformidad total de la luz en el techo, la instalación debe realizarse con una distancia mínima de 500 mm.

Temp. de color ◆

3000K	3
4000K	0

¹ Ver página 84.

02. Seleccionar opciones

OPCIONES	Código*
SwitchDIM	
• Mediante solicitud.	
Suspensión	
S11 L1500 mm (x4)	9129041
S11 L3000 mm (x4)	9129042
S11 L6000 mm (x4)	9129043
Cable de alimentación transparente	
L1500 mm - 3 x 0,75 mm ²	940400
L1500 mm - 5 x 0,75 mm ²	940500
L3000 mm - 3 x 0,75 mm ²	940401
L3000 mm - 5 x 0,75 mm ²	940501
L6000 mm - 3 x 0,75 mm ²	940402
L6000 mm - 5 x 0,75 mm ²	940507
Base circular	
Superficie T24 D95  Ø95	45 978600▲
Empotrar T5 D90  Ø70 33  Ø90	971300▲
Base de techo central	
Superficie T20 4l  Ø95	45 977202▲



*Sustituya los símbolos para completar el código

Color ▲

Blanco W

Negro B



Détail du produit



Luz indirecta



Difusor bFLEX



Base de techo



CONCEPT D 35



Características del productos

Cuerpo

Aluminio

Acabado

Pintado en epoxi-poliéster

Sistema óptico

bFLEX - Difusor opalino

Fuente de luz

LED, RG1, CRI>80, MacAdam Step ≤ 3

Vida útil del LED

70.000h @ L90, B10, Ta 25°C

Fuente de alimentación

Driver LED 220-240V-50/60Hz incluido



230V/50Hz



IP 40

bFLEX
960°C

01. Seleccionar versión

CONCEPT D 35



bFLEX - Difusor opalino

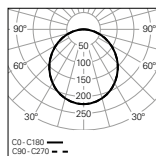

W	lm output	lm/W	Lmm	CÓDIGO*
108	9900	92	1187	90706L027▼▲◆0◆00
135	12376	92	1465	90706L033▼▲◆0◆00

CONCEPT D 35

• Para la versión suspendida, es necesario pedir suspensiones, cable y base de alimentación por separado.



*Sustituya los símbolos para completar el código







Fuente de alimentación	
HF	E
DALI	H

Color ¹	
□ Blanco	W
■ Gris	G
■ Negro	B
■ Sahara	0
■ Mist	1
■ Carbon	I
■ Autumn	L
■ Rusty chain	R
■ Jungle	N
■ Golden eye	D
■ Old rose	5
■ Copper	7

Temp. de color	
3000K	3
4000K	0

¹ Ver página 84.

02. Seleccionar opciones

OPCIONES		Código*
SwitchDIM		
• Mediante solicitud.		
Suspensión		
S11 L1500 mm (x3)		9129031
S11 L3000 mm (x3)		9129032
S11 L6000 mm (x3)		9129033
Cable de alimentación transparente		
L1500 mm - 3 x 0,75 mm ²		940400
L1500 mm - 5 x 0,75 mm ²		940500
L3000 mm - 3 x 0,75 mm ²		940401
L3000 mm - 5 x 0,75 mm ²		940501
L6000 mm - 3 x 0,75 mm ²		940402
L6000 mm - 5 x 0,75 mm ²		940507
Base circular		
Superficie T24 D95	45 l  Ø95	978600 
Empotrar T5 D90	 Ø70 33 l  Ø90	971300 
Base de techo central		
Superficie T20 3l	45 l  Ø95	977201 



*Sustituya los símbolos para completar el código

Color

<input type="checkbox"/> Blanco	W
<input checked="" type="checkbox"/> Negro	B



Détail du produit



Difusor bFLEX



Base de techo



CONCEPT D 35 D/I



Características del productos

Cuerpo

Aluminio



Acabado

Pintado en epoxi-poliéster

230V/50Hz

Sistema óptico

bFLEX - Difusor opalino



IP 40

Fuente de luz

LED, RG1, CRI>80, MacAdam Step ≤3

Vida útil del LED

70.000h @ L90, B10, Ta 25°C



Fuente de alimentación

Driver LED 220-240V-50/60Hz incluido

01. Seleccionar versión

CONCEPT D 35 D/I



bFLEX - Difusor opalino (80%/20%)

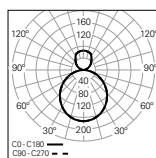

W	lm output	lm/W	Lmm	CÓDIGO*
135	12376	92	1187	90707L027▼▲0◆00
171	16090	94	1465	90707L033▼▲0◆00

CONCEPT D 35 D/I

- Para completar el producto es necesario pedir la suspensión, el cable y la base de alimentación por separado.
- Para garantizar una uniformidad total de la luz en el techo, la instalación debe realizarse con una distancia mínima de 500 mm.



*Sustituya los símbolos para completar el código





Fuente de alimentación	▼
HF	E
DALI	H

Color ¹	▲
Blanco	W
Gris	G
Negro	B
Sahara	0
Mist	1
Carbon	I
Autumn	L
Rusty chain	R
Jungle	N
Golden eye	D
Old rose	5
Copper	7

Temp. de color	◆
3000K	3
4000K	0

¹ Ver página 84.

02. Seleccionar opciones

OPCIONES	Código*
SwitchDIM	
• Mediante solicitud.	
Suspensión	
S11 L1500 mm (x3)	9129031
S11 L3000 mm (x3)	9129032
S11 L6000 mm (x3)	9129033
Cable de alimentación transparente	
L1500 mm - 3 x 0,75 mm ²	940400
L1500 mm - 5 x 0,75 mm ²	940500
L3000 mm - 3 x 0,75 mm ²	940401
L3000 mm - 5 x 0,75 mm ²	940501
L6000 mm - 3 x 0,75 mm ²	940402
L6000 mm - 5 x 0,75 mm ²	940507
Base circular	
Superficie T24 D95  Ø95	45 978600▲
Empotrar T5 D90  Ø70 33  Ø90	971300▲
Base de techo central	
Superficie T20 3l  Ø95	45 977201▲



*Sustituya los símbolos para completar el código

Color ▲

Blanco W

Negro B



Détail du produit



Luz indirecta



Difusor bFLEX



Base de techo





CONCEPT 65



CONCEPT S 65
138



CONCEPT S 65 D/I
142



CONCEPT O 65
146



CONCEPT O 65 D/I
150



Tipos de aplicación





1. Superficie

2. Suspendida
Direta

3. Suspendida
Directa / Indirecta

4. Pared



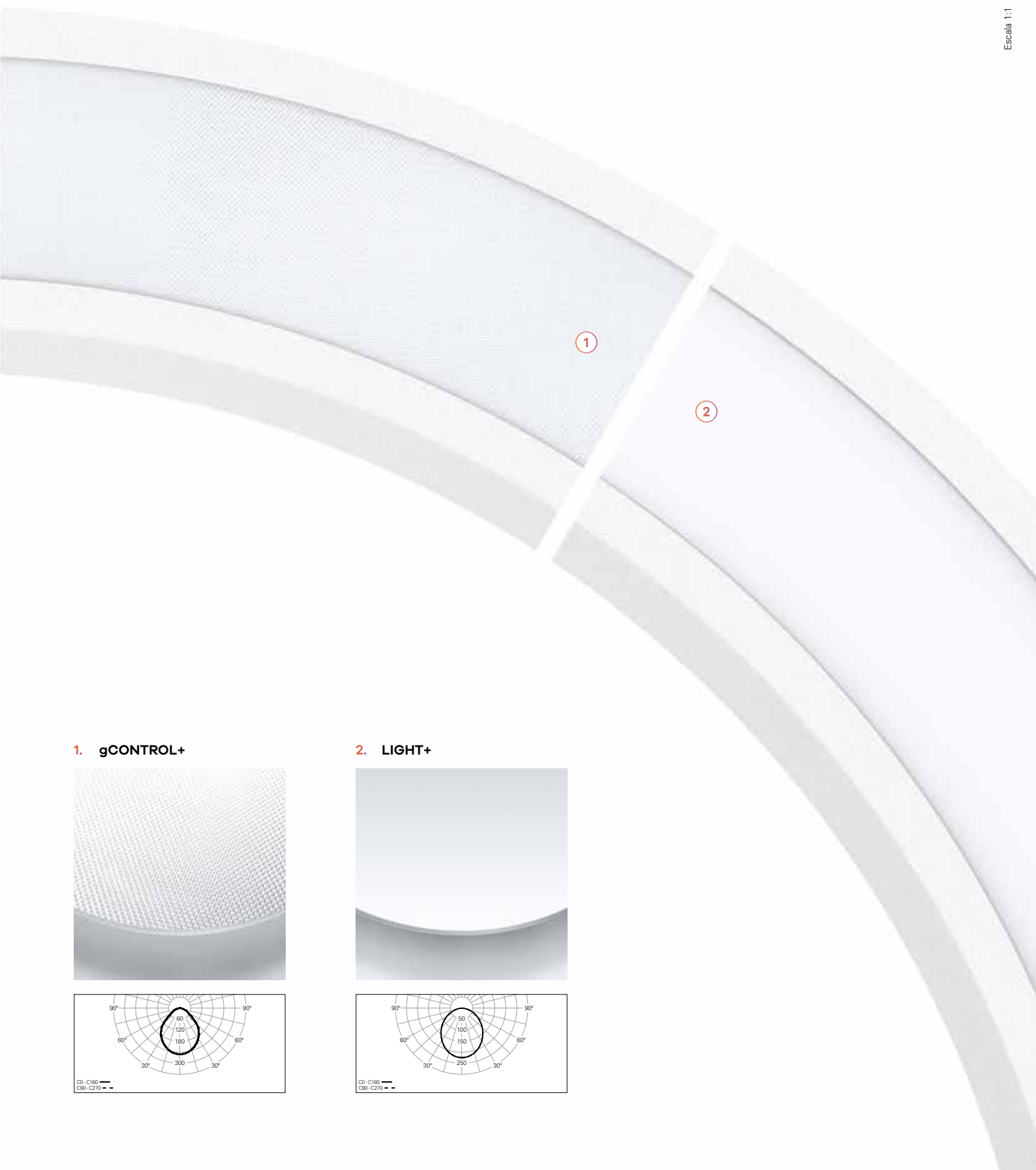

1. gCONTROL+

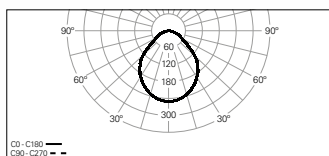

2. LIGHT+

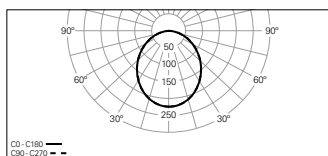

Defina su color

ILUMINACIÓN
ARQUITECTÓNICA

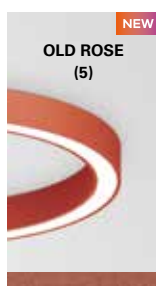
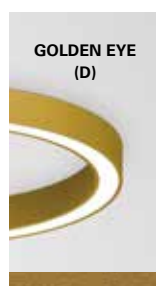
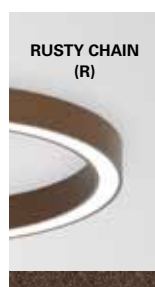
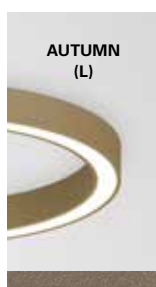
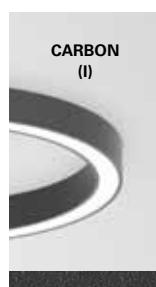
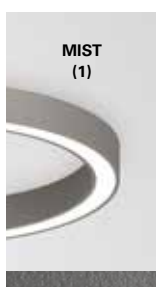
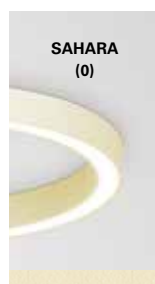
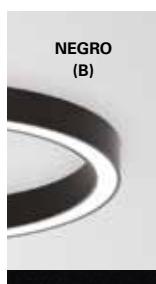
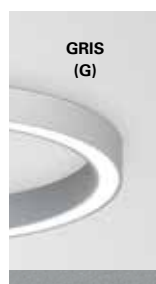
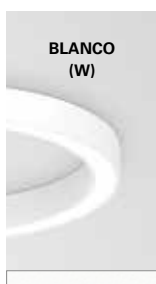

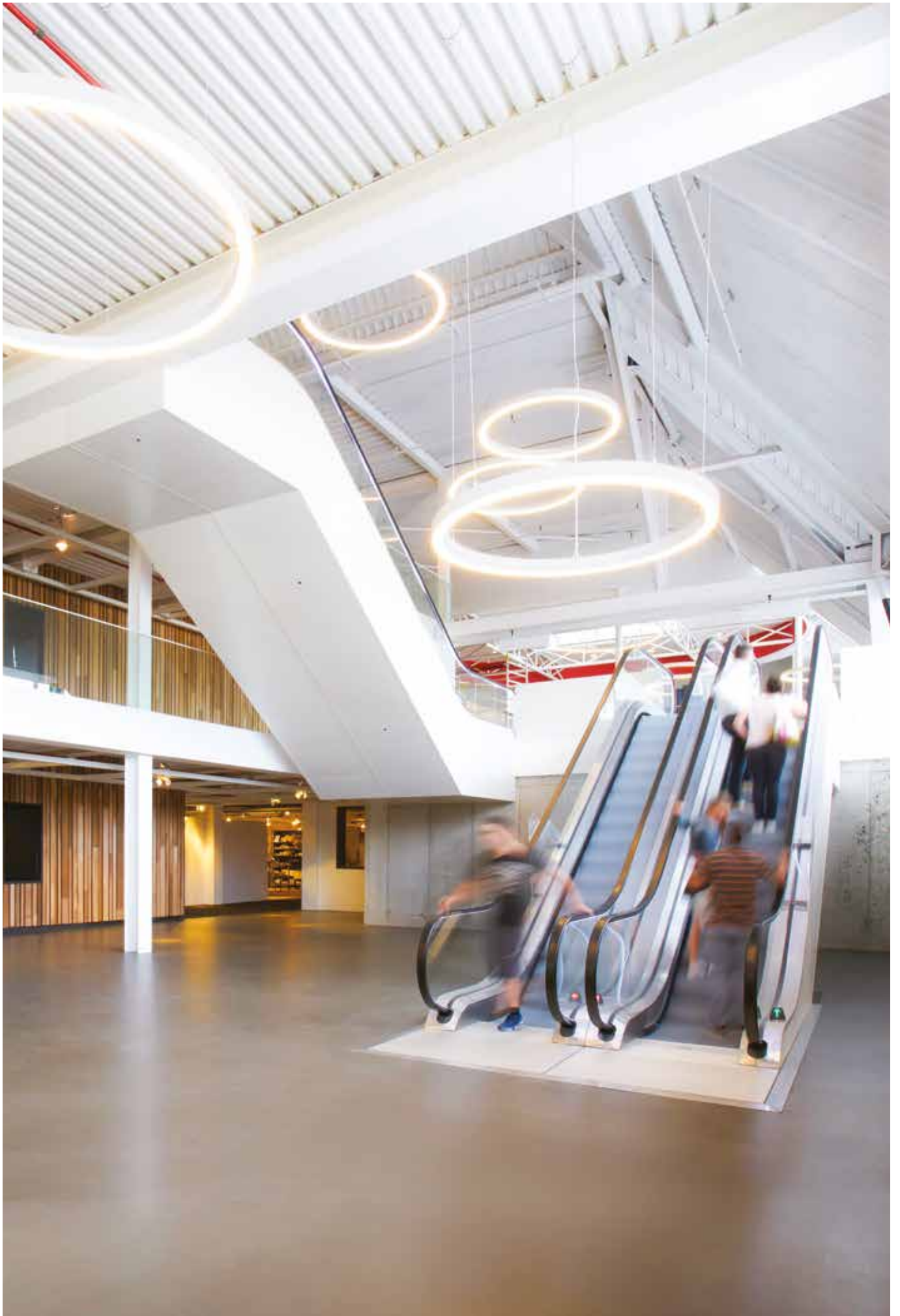

CONCEPT S 65



Características del productos

Cuerpo

Aluminio



Acabado

Pintado en epoxi-poliéster

230V/50Hz

Sistema óptico

LIGHT+ - Difusor opalino



IP 20

Fuente de luz

LED, RG1, CRI>80, MacAdam Step ≤ 3

Vida útil del LED

80.000h @ L80, B10, Ta 25°C

650°C

Fuente de alimentación

Driver LED 220-240V-50/60Hz incluido

01. Seleccionar módulo



MÓDULO CURVO

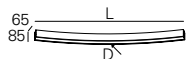

1/16 (22,5°) | LIGHT+ - Difusor opalino

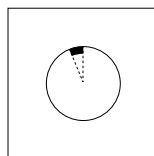

W	lm output	lm/W	Lmm	Dmm	CÓDIGO*
27	2776	103	1531	Ø7850	90781L010▼▲◆00

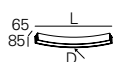

1/8 (45°) | LIGHT+ - Difusor opalino

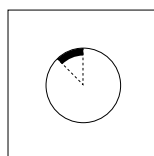

W	lm output	lm/W	Lmm	Dmm	CÓDIGO*
15	1388	93	784	Ø2050	90782L005▼▲◆00
18	1666	93	937	Ø2450	90782L006▼▲◆00
20	1943	97	1071	Ø2800	90782L007▼▲◆00
22	2221	101	1224	Ø3200	90782L008▼▲◆00

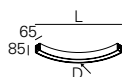

1/4 (90°) | LIGHT+ - Difusor opalino

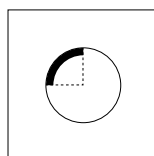

W	lm output	lm/W	Lmm	Dmm	CÓDIGO*
15	1388	93	742	Ø1050	90783L005▼▲◆00
18	1666	93	884	Ø1250	90783L006▼▲◆00
20	1943	97	1025	Ø1450	90783L007▼▲◆00
22	2221	101	1166	Ø1650	90783L008▼▲◆00
25	2498	100	1308	Ø1850	90783L009▼▲◆00
27	2776	103	1414	Ø2000	90783L010▼▲◆00
39	3886	100	1980	Ø2800	90783L014▼▲◆00
44	4441	101	2262	Ø3200	90783L016▼▲◆00
53	5552	105	2828	Ø4000	90783L020▼▲◆00

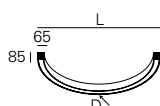

1/2 (180°) | LIGHT+ - Difusor opalino

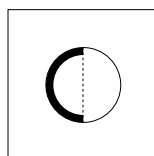

W	lm output	lm/W	Lmm	Dmm	CÓDIGO*
22	2221	101	850	Ø850	90784L008▼▲◆00
27	2776	103	1050	Ø1050	90784L010▼▲◆00
33	3331	101	1250	Ø1250	90784L012▼▲◆00
39	3886	100	1450	Ø1450	90784L014▼▲◆00
44	4441	101	1650	Ø1650	90784L016▼▲◆00
48	4997	104	1850	Ø1850	90784L018▼▲◆00
53	5552	105	2000	Ø2000	90784L020▼▲◆00

MÓDULO LINEAL

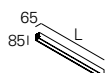

LINEA | LIGHT+ - Difusor opalino

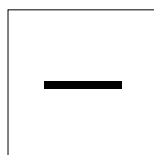

W	lm output	lm/W	Lmm	CÓDIGO*
15	1388	93	750	90789L005▼▲◆00
20	1943	97	1050	90789L007▼▲◆00
25	2498	100	1350	90789L009▼▲◆00
30	3053	102	1650	90789L011▼▲◆00
36	3609	100	1950	90789L013▼▲◆00

MÓDULO CURVO | MÓDULO LINEAL

- Para completar una línea, es necesario un Start Kit, cableado de línea continua y kit de unión. Por favor solicítelo por separado.
- Para la versión suspendida, es necesario pedir suspensiones, cable y base de alimentación por separado.
- Las dimensiones no incluyen el star kit. Incremente 4 mm a la longitud para completar la línea.

*Sustituya los símbolos para completar el código

Fuente de alimentación ▼
HF E
DALI H





Color ¹ ▲

- Blanco W
- Gris G
- Negro B
- Sahara 0
- Mist 1
- Carbon I
- Autumn L
- Rusty chain R
- Jungle N
- Golden eye D
- Old rose 5
- Copper 7

Temp. de color ◆
3000K 3
4000K 0

¹ Ver página 136.

02. Seleccionar opciones

OPCIONES	Código*
Start kit - Tapas inicio/final • Dos tapas finales incluidas.	65 921750♣ 851  2
Cableado de línea continua 3 x 1,5 m ² 5 x 1,5 m ²	949200 949201
Kit de unión (x1) • Tornillos incluidos.	931100♣
Suspensión • Para todas las versiones curvas:	
S1 L1500 mm (x3)	910005
S1 L3000 mm (x3)	910015
S1 L6000 mm (x3)	910016
• Para todas las versiones y rectas:	
S1 L1500 mm (x2)	910001
S1 L3000 mm (x2)	910011
S1 L6000 mm (x2)	910012
Cable de alimentación transparente L1500 mm - 3 x 1,5 mm ² L1500 mm - 5 x 1,5 mm ² L3000 mm - 3 x 1,5 mm ² L3000 mm - 5 x 1,5 mm ² L6000 mm - 3 x 1,5 mm ² L6000 mm - 5 x 1,5 mm ²	940300 940000 940301 940001 940302 940002
Base circular¹	
Superficie T24 D95  45 Ø95	978600♣
Empotrar T5 D90  Ø70 33  Ø90	971300♣



*Sustituya los símbolos para completar el código

Color ^{1,2}	♣
<input type="checkbox"/> Blanco	W
<input type="checkbox"/> Gris	G
<input type="checkbox"/> Negro	B
<input type="checkbox"/> Sahara	0
<input type="checkbox"/> Mist	1
<input type="checkbox"/> Carbon	I
<input type="checkbox"/> Autumn	L
<input type="checkbox"/> Rusty chain	R
<input type="checkbox"/> Jungle	N
<input type="checkbox"/> Golden eye	D
<input type="checkbox"/> Old rose	5
<input type="checkbox"/> Copper	7



Détail du produit



Difusor LIGHT+



Base de techo



CONCEPT S 65 D/I



Características del productos

Cuerpo

Aluminio



Acabado

Pintado en epoxi-poliéster

230V/50Hz

Sistema óptico

LIGHT+ - Difusor opalino



IP 20

Fuente de luz

LED, RG1, CRI>80, MacAdam Step ≤3

Vida útil del LED

80.000h @ L80, B10, Ta 25°C

650°C

Fuente de alimentación

Driver LED 220-240V-50/60Hz incluido

01. Seleccionar módulo



MÓDULO CURVO

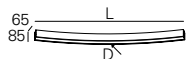

1/16 (22,5°) | LIGHT+ - Difusor opalino (80%/20%)

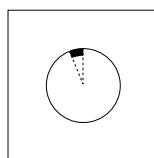

W	lm output	lm/W	Lmm	Dmm	CÓDIGO*
33	3390	103	1531	Ø7850	90785L010▼▲◆0◆00

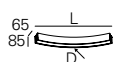

1/8 (45°) | LIGHT+ - Difusor opalino (80%/20%)

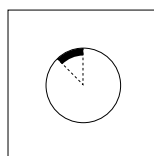

W	lm output	lm/W	Lmm	Dmm	CÓDIGO*
22	2260	103	1071	Ø2800	90786L007▼▲◆0◆00
25	2542	102	1224	Ø3200	90786L008▼▲◆0◆00

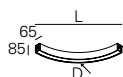

1/4 (90°) | LIGHT+ - Difusor opalino (80%/20%)

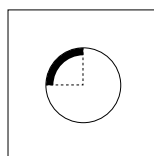

W	lm output	lm/W	Lmm	Dmm	CÓDIGO*
25	2542	102	1164	Ø1650	90787L008▼▲◆0◆00
30	3107	104	1305	Ø1850	90787L009▼▲◆0◆00
33	3390	103	1411	Ø2000	90787L010▼▲◆0◆00
47	4802	102	1977	Ø2800	90787L014▼▲◆0◆00
50	5367	107	2260	Ø3200	90787L016▼▲◆0◆00
63	6497	103	2826	Ø4000	90787L020▼▲◆0◆00

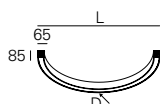

1/2 (180°) | LIGHT+ - Difusor opalino (80%/20%)

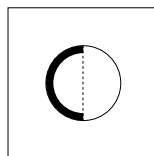

W	lm output	lm/W	Lmm	Dmm	CÓDIGO*
33	3390	103	1050	Ø1050	90788L010▼▲◆0◆00
39	3954	101	1250	Ø1250	90788L012▼▲◆0◆00
47	4802	102	1450	Ø1450	90788L014▼▲◆0◆00
50	5367	107	1650	Ø1650	90788L016▼▲◆0◆00
55	5932	108	1850	Ø1850	90788L018▼▲◆0◆00
63	6497	103	2000	Ø2000	90788L020▼▲◆0◆00

MÓDULO LINEAL

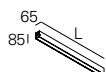

LINEA | LIGHT+ - Difusor opalino (80%/20%)

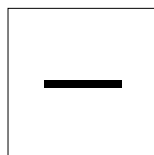

W	lm output	lm/W	Lmm	CÓDIGO*
30	3118	104	1350	90790L009▼▲◆0◆00
39	3976	102	1650	90790L011▼▲◆0◆00
44	4502	102	1950	90790L013▼▲◆0◆00

*Sustituya los símbolos para completar el código

Fuente de alimentación ▼
 HF E
 DALI H

Color ¹ ▲
 □ Blanco W
 ■ Gris G
 ■ Negro B
 ■ Sahara 0
 ■ Mist 1
 ■ Carbon I
 ■ Autumn L
 ■ Rusty chain R
 ■ Jungle N
 ■ Golden eye D
 ■ Old rose 5
 ■ Copper 7





Temp. de color ◆
 3000K 3
 4000K 0

MÓDULO CURVO | MÓDULO LINEAL

- Para completar una línea, es necesario un Start Kit, cableado de línea continua y kit de unión. Por favor solicítelo por separado.
- Para completar el producto es necesario pedir la suspensión, el cable y la base de alimentación por separado.
- Las dimensiones no incluyen el star kit. Incremente 4 mm a la longitud para completar la línea.
- Para garantizar una uniformidad total de la luz en el techo, la instalación debe realizarse con una distancia mínima de 500 mm.

¹ Ver página 136.

02. Seleccionar opciones

OPCIONES	Código*
Start kit - Tapas inicio/final	65 921750♣
• Dos tapas finales incluidas.	85  2
Cableado de línea continua	
3 x 1,5 mm ²	949200
5 x 1,5 mm ²	949201
Kit de unión (x1)	931100♣
• Tornillos incluidos.	
Suspensión	
• Para todas las versiones curvas:	
S1 L1500 mm (x3)	910005
S1 L3000 mm (x3)	910015
S1 L6000 mm (x3)	910016
• Para todas las versiones y rectas:	
S1 L1500 mm (x2)	910001
S1 L3000 mm (x2)	910011
S1 L6000 mm (x2)	910012
Cable de alimentación transparente	
L1500 mm - 3 x 1,5 mm ²	940300
L1500 mm - 5 x 1,5 mm ²	940000
L3000 mm - 3 x 1,5 mm ²	940301
L3000 mm - 5 x 1,5 mm ²	940001
L6000 mm - 3 x 1,5 mm ²	940302
L6000 mm - 5 x 1,5 mm ²	940002
Base circular¹	
Superficie T24 D95  45  Ø95	978600♣
Empotrar T5 D90  Ø70 33  Ø90	971300♣



*Sustituya los símbolos para completar el código

Color ^{1,2}	♣
<input type="checkbox"/> Blanco	W
<input type="checkbox"/> Gris	G
<input type="checkbox"/> Negro	B
<input type="checkbox"/> Sahara	0
<input type="checkbox"/> Mist	1
<input type="checkbox"/> Carbon	I
<input type="checkbox"/> Autumn	L
<input type="checkbox"/> Rusty chain	R
<input type="checkbox"/> Jungle	N
<input type="checkbox"/> Golden eye	D
<input type="checkbox"/> Old rose	5
<input type="checkbox"/> Copper	7



Détail du produit



Difusor LIGHT+



Luz indirecta



Base de techo



CONCEPT O 65



Características del producto

Cuerpo

Aluminio

Acabado

Pintado en epoxi-poliéster

Sistema óptico

gCONTROL+ - Difusor microprismático
LIGHT+ - Difusor opalino

Fuente de luz

LED, RG1, CRI>80, MacAdam Step ≤3

Vida útil del LED

80.000h @ L90, B10, Ta 25°C

Fuente de alimentación

Driver LED 220-240V-50/60Hz incluido



230V/50Hz



IP 20

650°C

01. Seleccionar versión

CONCEPT O 65

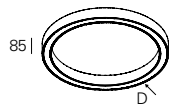

gCONTROL+ - Difusor microprismático

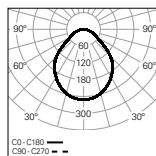

UGR	W	lm output	lm/W	Dmm	CÓDIGO*
≤19	38	3722	98	Ø600	90625L600▼▲0◆00
≤19	54	5377	100	Ø900	90625L900▼▲◆◆00
≤19	77	7858	102	Ø1200	90625L120▼▲◆◆00
≤19	91	9099	100	Ø1500	90625L150▼▲◆◆00

LIGHT+ - Difusor opalino

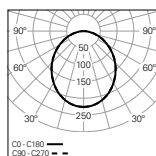

UGR	W	lm output	lm/W	Dmm	CÓDIGO*
≤22	38	3993	105	Ø600	90635L600▼▲0◆00
≤22	54	5768	107	Ø900	90635L900▼▲◆◆00
≤22	77	8430	109	Ø1200	90635L120▼▲◆◆00
≤22	91	9761	107	Ø1500	90635L150▼▲◆◆00

CONCEPT O 65

• Para la versión suspendida, es necesario pedir suspensiones, cable y base de alimentación por separado.



*Sustituya los símbolos para completar el código

Fuente de alimentación	
HF	E
DALI	H

Color ¹	
Blanco	W
Gris	G
Negro	B
Sahara	0
Mist	1
Carbon	I
Autumn	L
Rusty chain	R
Jungle	N
Golden eye	D
Old rose	5
Copper	7





Emergencia	
No EM	0
EM 3h (K3) ²	3

Temp. de color	
3000K	3
4000K	0

¹ Ver página 136.

² Preparado para telemando.

02. Seleccionar opciones

OPCIONES	Código*
Bluetooth	927200
• Módulo Bluetooth controlable por smartphone.	
Suspensión	
S10 L1500 mm (x3)	9111001
S10 L3000 mm (x3)	9111002
S10 L6000 mm (x3)	9111003
Cable de alimentación transparente	
L1500 mm - 3 x 0,75 mm ²	940400
L1500 mm - 5 x 0,75 mm ²	940500
L1500 mm - 7 x 0,75 mm ²	940600
L3000 mm - 3 x 0,75 mm ²	940401
L3000 mm - 5 x 0,75 mm ²	940501
L3000 mm - 7 x 0,75 mm ²	940601
L6000 mm - 3 x 0,75 mm ²	940402
L6000 mm - 5 x 0,75 mm ²	940507
L6000 mm - 7 x 0,75 mm ²	940602
• Para la opción DALI con kit de emergencia teledomable, es necesario solicitar 2 cables de alimentación de 5 x 0,75 mm ² .	
Base circular	
Superficie T24 D95  Ø95	978600♣
Superficie T26 D95 (DALI+K3)	978601♣
Empotrar T5 D90  Ø70 33 l  Ø90	971300♣
Empotrar T27 D90 (DALI+K3)	978700♣
Base de techo central	
Superficie T21 3l D95  Ø95	977211♣
Superficie T28 3l D95 (DALI+K3)	977230♣



*Sustituya los símbolos para completar el código

Color 

Blanco W

Negro B



Détail du produit



Aplicación de superficie

Aplicación suspendida



Aplicación suspendida con base de techo central

Aplicación de Pared



Difusor gCONTROL+

Difusor LIGHT+

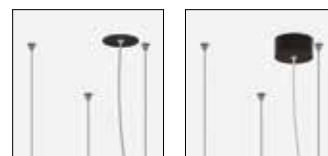

Suspensión paralela con base de techo de empotrar

Suspensión paralela con base de techo de saliente



Suspensión central

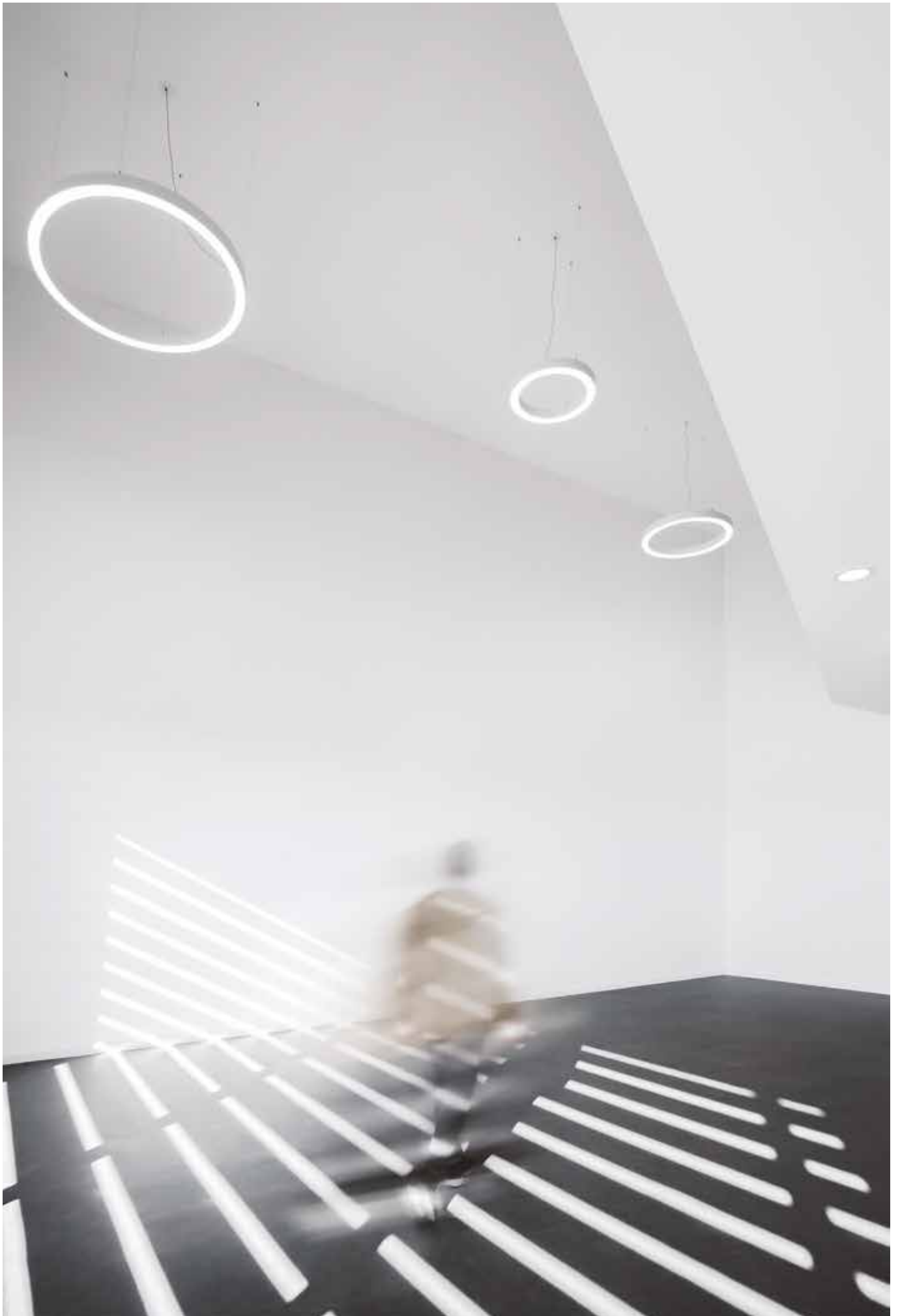

CONCEPT O 65 D/I



Características del producto

Cuerpo

Aluminio

Acabado

Pintado en epoxi-poliéster

Sistema óptico

gCONTROL+ - Difusor microprismático
LIGHT+ - Difusor opalino

Fuente de luz

LED, RG1, CRI>80, MacAdam Step ≤3

Vida útil del LED

80.000h @ L90, B10, Ta 25°C

Fuente de alimentación

Driver LED 220-240V-50/60Hz incluido



230V/50Hz



IP 20

650°C

01. Seleccionar versión

CONCEPT O 65 D/I

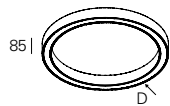

gCONTROL+ - Difusor microprismático (80%/20%)

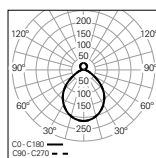

UGR	W	lm output	lm/W	Dmm	CÓDIGO*
≤19	44	4580	104	Ø600	90626L600▼▲◆0◆00
≤19	63	6651	106	Ø900	90626L900▼▲◆◆◆00
≤19	92	9596	104	Ø1200	90626L120▼▲◆◆◆00
≤19	110	11558	105	Ø1500	90626L150▼▲◆◆◆00

LIGHT+ - Difusor opalino (80%/20%)

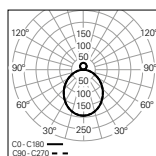

UGR	W	lm output	lm/W	Dmm	CÓDIGO*
≤22	44	4817	109	Ø600	90636L600▼▲◆0◆00
≤22	63	6995	111	Ø900	90636L900▼▲◆◆◆00
≤22	92	10092	110	Ø1200	90636L120▼▲◆◆◆00
≤22	110	12156	111	Ø1500	90636L150▼▲◆◆◆00

CONCEPT O 65

- Para completar el producto es necesario pedir la suspensión, el cable y la base de alimentación por separado.
- Para garantizar una uniformidad total de la luz en el techo, la instalación debe realizarse con una distancia mínima de 500 mm.



*Sustituya los símbolos para completar el código

Fuente de alimentación	
HF	E
DALI	H



Color ¹	
Blanco	W
Gris	G
Negro	B
Sahara	0
Mist	1
Carbon	I
Autumn	L
Rusty chain	R
Jungle	N
Golden eye	D
Old rose	5
Copper	7

Emergencia	
No EM	0
EM 3h (K3) ²	3

Temp. de color	
3000K	3
4000K	0

¹ Ver página 136.
² Preparado para teledmando.

02. Seleccionar opciones

OPCIONES	Código*
Bluetooth	927200
• Módulo Bluetooth controlable por smartphone.	
Suspensión	
S10 L1500 mm (x3)	9111001
S10 L3000 mm (x3)	9111002
S10 L6000 mm (x3)	9111003
Cable de alimentación transparente	
L1500 mm - 3 x 0,75 mm ²	940400
L1500 mm - 5 x 0,75 mm ²	940500
L1500 mm - 7 x 0,75 mm ²	940600
L3000 mm - 3 x 0,75 mm ²	940401
L3000 mm - 5 x 0,75 mm ²	940501
L3000 mm - 7 x 0,75 mm ²	940601
L6000 mm - 3 x 0,75 mm ²	940402
L6000 mm - 5 x 0,75 mm ²	940507
L6000 mm - 7 x 0,75 mm ²	940602
• Para la opción DALI con kit de emergencia telemandable, es necesario solicitar 2 cables de alimentación de 5 x 0,75 mm ² .	
Base circular	
Superficie T24 D95  45 l Ø95	978600♣
Superficie T26 D95 (DALI+K3)	978601♣
Empotrar T5 D90  Ø70 33 l Ø90	971300♣
Empotrar T27 D90 (DALI+K3)	978700♣
Base de techo central	
Superficie T21 3l D95  45 l Ø95	977211♣
Superficie T28 3l D95 (DALI+K3)	977230♣



*Sustituya los símbolos para completar el código

Color 

Blanco W

Negro B



Détail du produit



Aplicación suspendida



Aplicación suspendida con base de techo central



Difusor gCONTROL+



Difusor LIGHT+



Luz indirecta



Suspensión paralela con base de techo de empotrar



Suspensión paralela con base de techo de saliente



Suspensión central

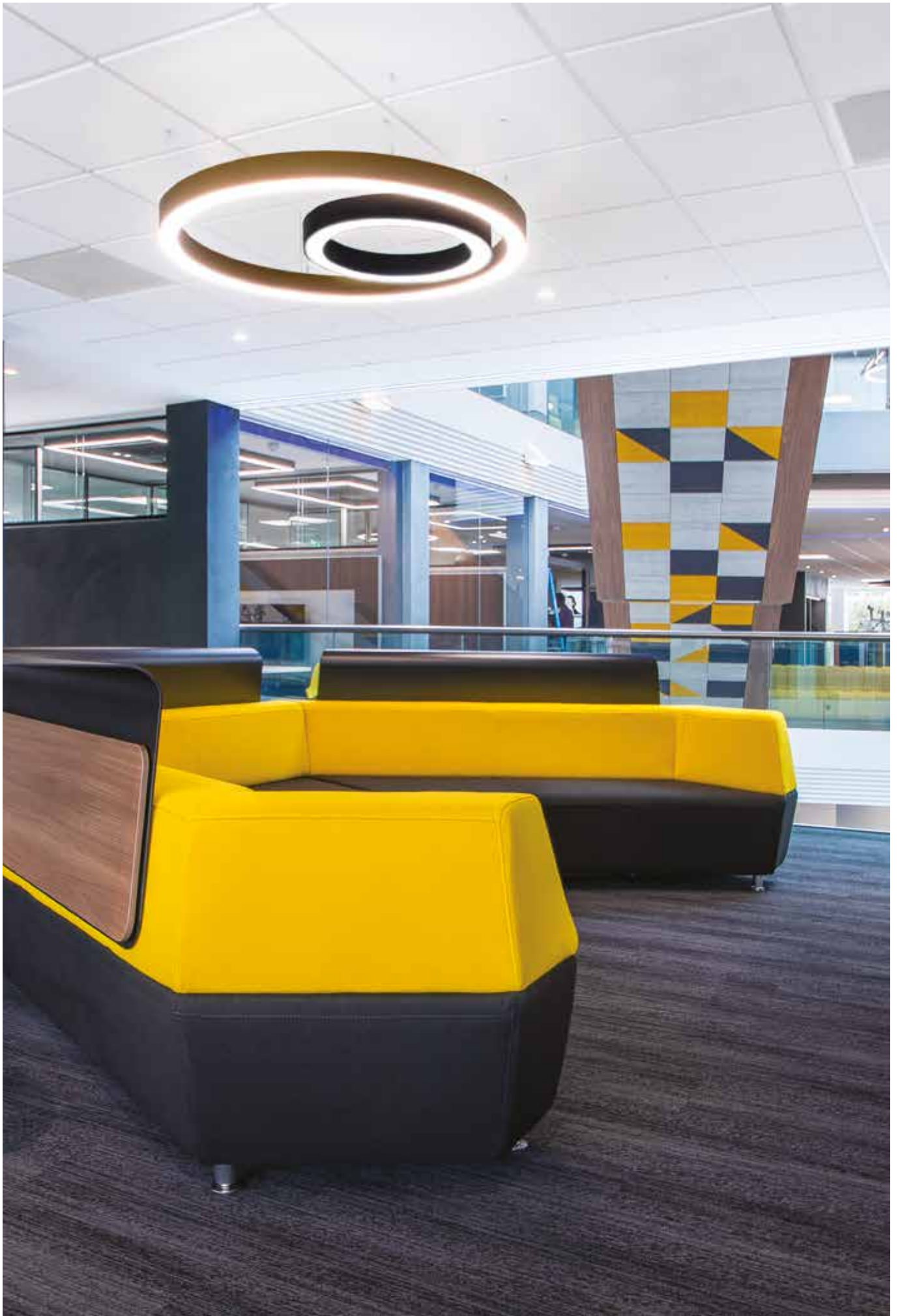

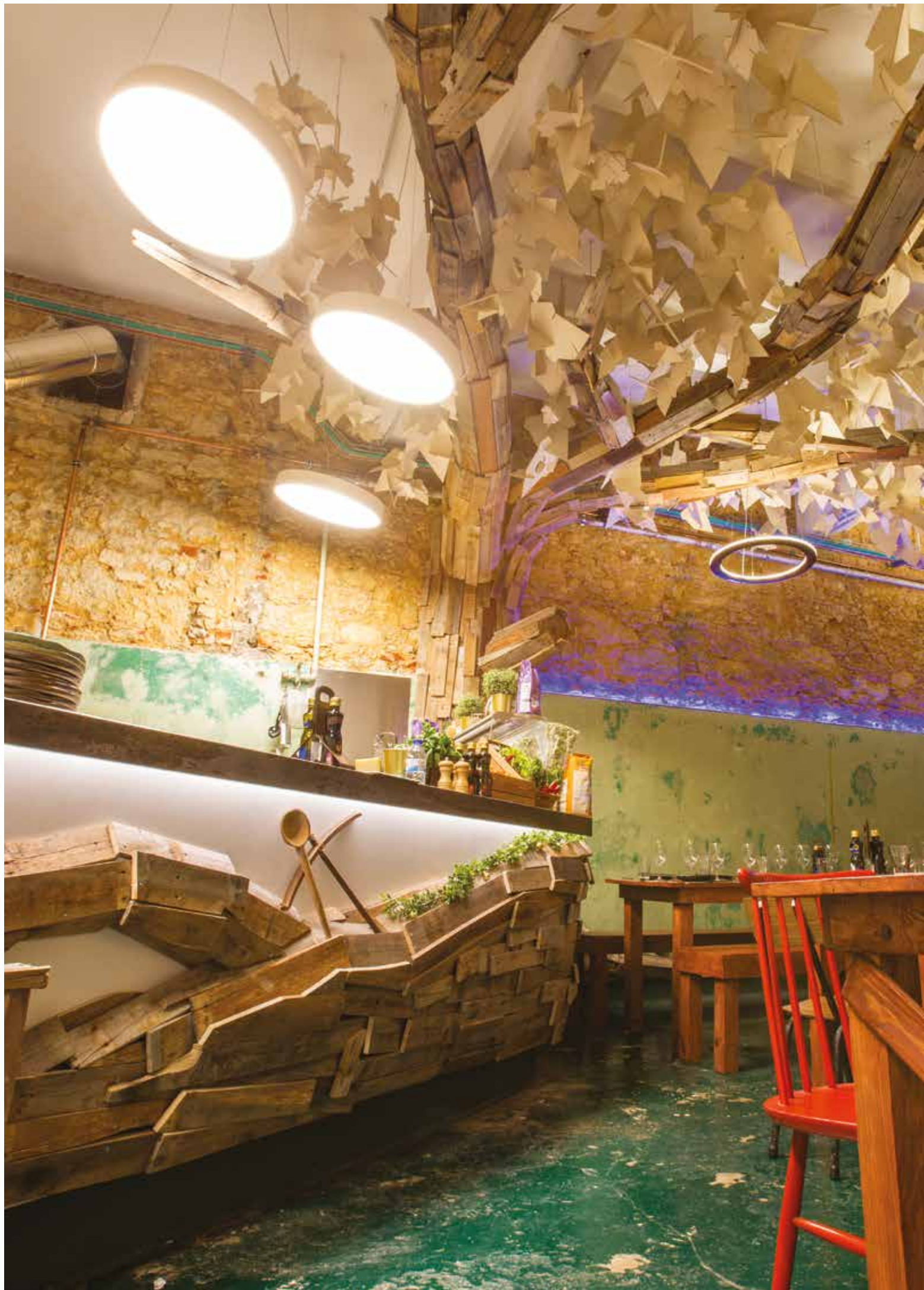

ROFY



ROFY 60 / T
166



ROFY 60 / T D/I
168



ROFY 60
172



ROFY 60 D/I
176



ROFY 85 / E
180



ROFY 85
182



ROFY 85 D/I
186



ROFY 85 IP / E
190



ROFY 85 IP / C
192



Tipos de aplicación





**1. Empotrable
con marco**

**2. Trimless
Directa**

**3. Trimless
Directa / Indirecta**

**4. Pared
Directa**

**5. Pared
Directa / Indirecta**

**6. Superficie
Directa**

**7. Superficie
Directa / Indirecta**

**8. Suspensión
Directa**

**9. Suspensión
Directa / Indirecta**

**Dos versiones
disponibles**



ROFY 60



25 mm

60 mm



ROFY 85

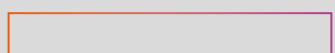

85 mm



1. gCONTROL+

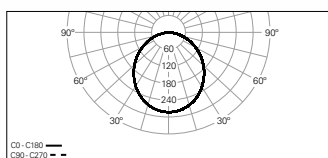

2. LIGHT+

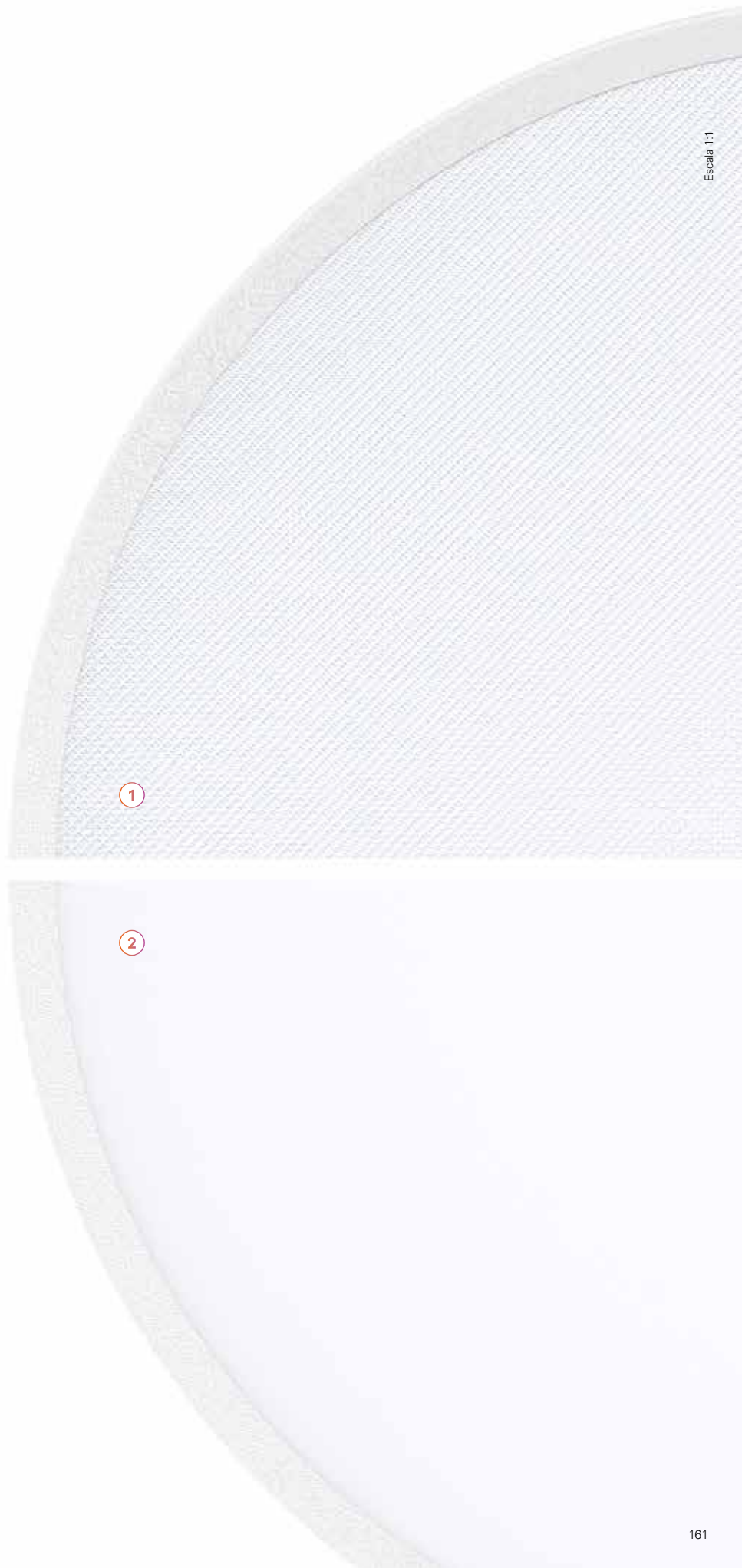
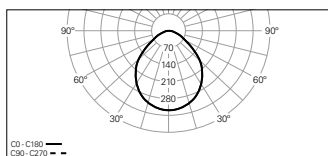

Minimalismo y tecnología

1. Cuerpo

Perfil de aluminio soldado sin marcas, disponible en 12 colores.

2. LED

SDCM MacAdam ≤ 3 , temperatura de color 3000K / 4000K, CRI > 80 y vida útil de 80.000h L90 B10.

3. Tunable White

Versiones Tunable White disponibles con un espectro de blancos de 2700K a 6500K. Disponible para tamaños a partir de $\varnothing 400$ mm.



4. gCONTROL+ o LIGHT+

Sistema óptico de alta tecnología con versión opalina LIGHT+ para garantizar una luz suave e uniforme, o microprismática gCONTROL+ de elevado confort visual (UGR < 19) e sem pontos visíveis.



5. HPR

Reflector interno de alto rendimiento para garantizar una alta eficiencia y una luz suave y uniforme.



6. Luz indirecta

Versión directa / indirecta con 80% / 20% de proporción de luz y difusor opalino para uniformidad de la luz en el techo.

7. Fuente de alimentación DALI o HF

8. Suspensión y cable de alimentación

Gracias a una amplia gama de suspensiones y bases de alimentación, puede optar por una suspensión de techo muy minimalista. La suspensión central permite que la luminaria se integre sutilmente en cualquier proyecto. Suspensiones y cables de alimentación disponibles en longitudes de 1500, 3000 o 6000 mm.

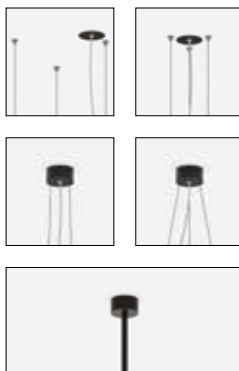

9. Base de techo

Bases empotradas, de superficie o centrales disponibles en color blanco o negro.



10. Kit de emergencia

Kit de emergencia de 3 horas. Disponible desde $\varnothing 600$ hasta $\varnothing 1150$ mm.

11. Versión IP

Índice de protección contra el agua y el polvo IP54 disponible.



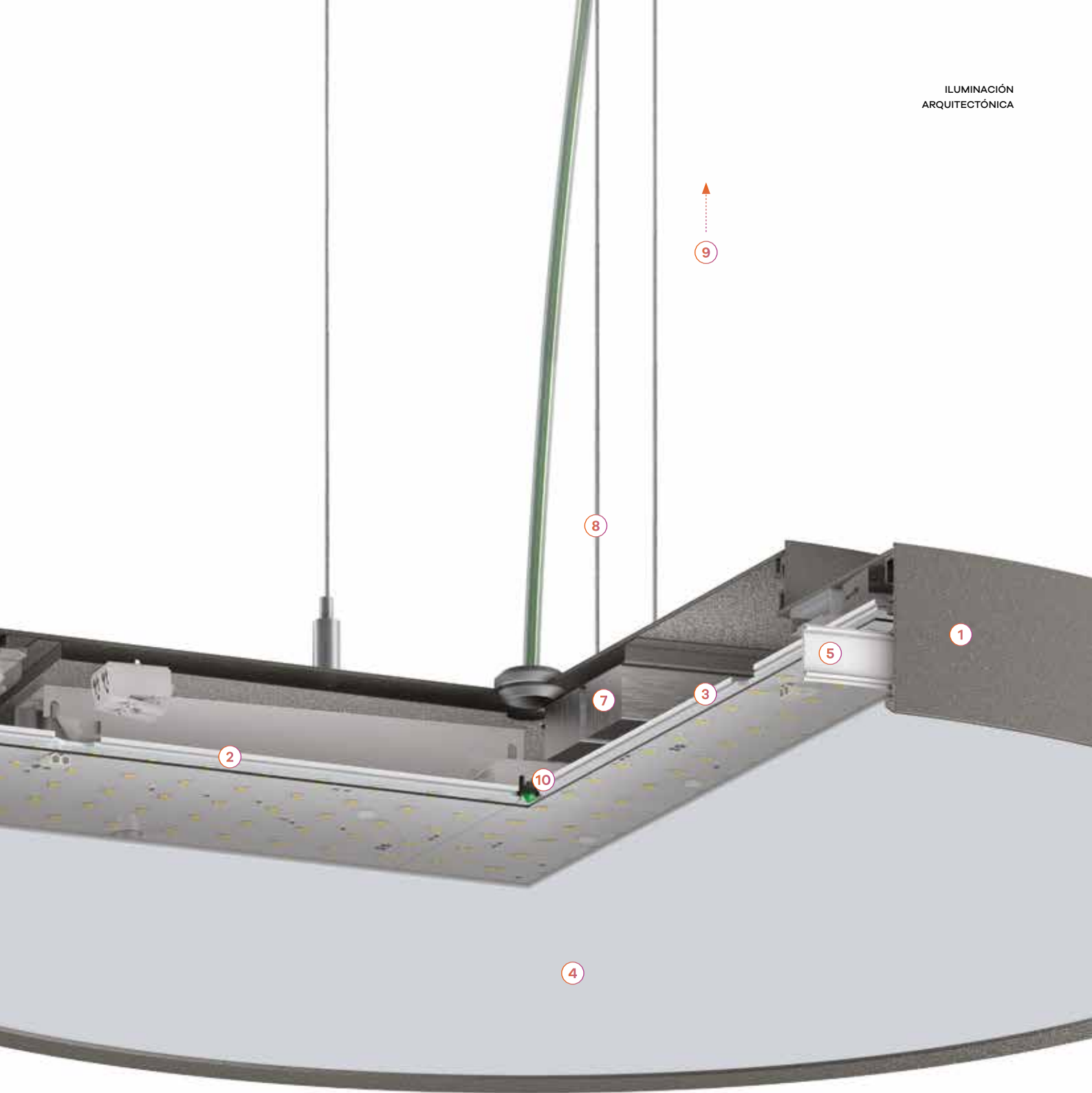

Defina su color

ILUMINACIÓN
ARQUITECTÓNICA

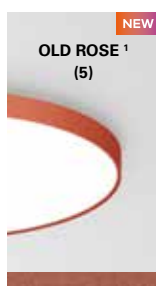
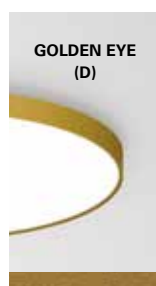
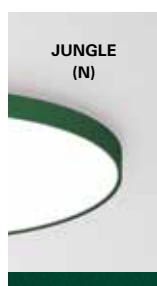
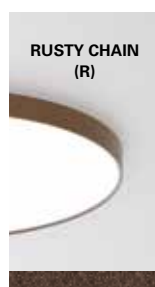
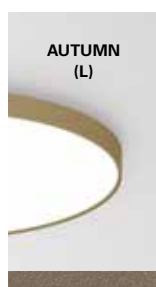
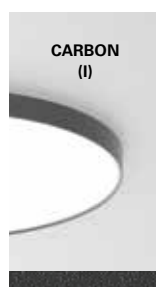
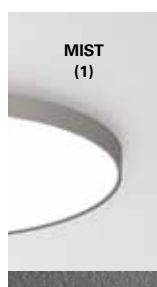
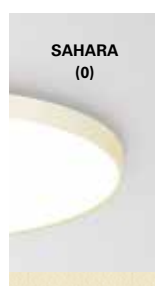
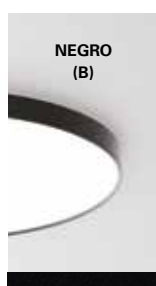
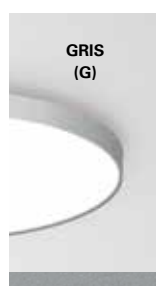
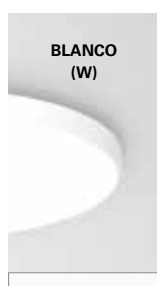



ROFY 60 /T



Características del productos

Cuerpo

Aluminio

Acabado

Pintado en epoxi-poliéster

Sistema óptico

gCONTROL+ - Difusor microprismático
LIGHT+ - Difusor opalino

Fuente de luz

LED, RG1, CRI>80, MacAdam Step ≤3

Vida útil del LED

80.000h @ L90, B10, Ta 25°C

Fuente de alimentación

Driver LED 220-240V-50/60Hz incluido

Espesor del techo

Para techos entre 9,5-18 mm



230V/50Hz

IP 40

IK 04

650°C



01. Seleccionar versión

ROFY 60 /T



gCONTROL+ - Difusor microprismático

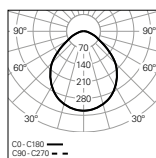

UGR	W	lm output	lm/W	Dmm	Ø	Ø	CÓDIGO*
≤22	16	1945	122	Ø300	Ø331	Ø331	90559L300▼▲◆000
≤22	24	3085	129	Ø400	Ø427	Ø427	90559L400▼▲◆000
≤19	43	5939	138	Ø600	Ø630	Ø630	90559L600▼▲◆000
≤19	65	8844	136	Ø900	Ø927	Ø927	90559L900▼▲◆000
≤19	107	14432	135	Ø1150	Ø1179	Ø1179	90559L115▼▲◆000

LIGHT+ - Difusor opalino

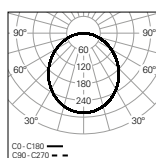

UGR	W	lm output	lm/W	Dmm	Ø	Ø	CÓDIGO*
≤22	16	2135	133	Ø300	Ø331	Ø331	90561L300▼▲◆000
≤25	24	3385	141	Ø400	Ø427	Ø427	90561L400▼▲◆000
≤22	43	6516	152	Ø600	Ø630	Ø630	90561L600▼▲◆000
≤22	65	9704	149	Ø900	Ø927	Ø927	90561L900▼▲◆000
≤22	107	15835	148	Ø1150	Ø1179	Ø1179	90561L115▼▲◆000

ROFY 60 /T

• Este producto no se puede aplicar a la pared.



*Sustituya los símbolos para completar el código

Fuente de alimentación ▼
 HF E
 DALI H

Color ¹ ▲
 □ Blanco W
 ■ Gris G
 ■ Negro B
 ■ Sahara 0
 ■ Mist 1
 ■ Carbon I
 ■ Autumn L
 ■ Rusty chain R
 ■ Jungle N
 ■ Golden eye D

Emergencia ●
 No EM 0
 EM 3h (K3) ² 3

Temp. de color ◆
 3000K 3
 4000K 0
 Tunable White ³ T

02. Seleccionar opciones

OPCIONES Código

Cable de seguridad en acero
 L1500 mm 955000

Versión de baja potencia

• Mediante solicitud.



Detalles del producto

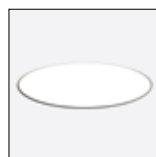

Aplicación trimless



Difusor gCONTROL+



Difusor LIGHT+

¹ Ver página 164.

² Preparado para teledando. Sólo disponible en las versiones de Ø600, Ø900 y Ø1150 mm.

³ No disponible en las versiones de Ø300 mm.

ROFY 60 /T D/I



Características del producto

Cuerpo

Aluminio

Acabado

Pintado en epoxi-poliéster

Sistema óptico

gCONTROL+ - Difusor microprismático
LIGHT+ - Difusor opalino

Fuente de luz

LED, RG1, CRI>80, MacAdam Step ≤3

Vida útil del LED

80.000h @ L90, B10, Ta 25°C

Fuente de alimentación

Driver LED 220-240V-50/60Hz incluido

Espesor del techo

Para techos entre 9,5-18 mm



230V/50Hz

IP 40

IK 04

650°C



01. Seleccionar versión

ROFY 60 /T D/I



gCONTROL+ - Difusor microprismático (80%/20%)

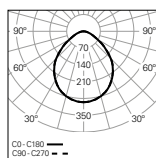

UGR	W	lm output	lm/W	Hmm	Dmm	Ø	Ø	CÓDIGO*
≤19	32	3683	115	119	Ø400	Ø523		90591L400▼▲◆0◆00
≤19	56	6869	123	119	Ø600	Ø723		90591L600▼▲◆◆◆00
≤19	84	10270	122	135	Ø900	Ø1023		90591L900▼▲◆◆◆00
≤19	137	16846	123	135	Ø1150	Ø1273		90591L115▼▲◆◆◆00

LIGHT+ - Difusor opalino (80%/20%)

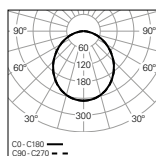

UGR	W	lm output	lm/W	Hmm	Dmm	Ø	Ø	CÓDIGO*
≤22	32	3851	120	119	Ø400	Ø523		90593L400▼▲◆0◆00
≤22	56	7182	128	119	Ø600	Ø723		90593L600▼▲◆◆◆00
≤22	84	10736	128	135	Ø900	Ø1023		90593L900▼▲◆◆◆00
≤22	137	17612	129	135	Ø1150	Ø1273		90593L115▼▲◆◆◆00

ROFY 60 /T D/I

• Este producto no se puede aplicar a la pared.



*Sustituya los símbolos para completar el código

Fuente de alimentación ▼

HF	E
DALI	H
HF+CD ¹	Q
SWD+CD ²	Y

Color³ ▲

Blanco	W
Gris	G
Negro	B
Sahara	0
Mist	1
Carbon	I
Autumn	L
Rusty chain	R
Jungle	N
Golden eye	D

Emergencia ●

No EM	0
EM 3h (K3) ⁴	3

Temp. de color ◆

3000K	3
4000K	0
Tunable White	T

02. Seleccionar opciones

OPCIONES Código

SopORTE inclinado

Ø400 mm	927100
Ø600 mm	927101
Ø900 mm	927102
Ø1150 mm	927103

Cable de seguridad en acero

L1500 mm	955000
----------	--------

Versión de baja potencia

• Mediante solicitud.



Detalles del producto



Aplicación trimless



SopORTE inclinado



Difusor gCONTROL+



Difusor LIGHT+

¹ HF + Doble circuito.

² SwitchDIM + Doble circuito.

³ Ver página 164.

⁴ Preparado para telemando. Sólo disponible en las versiones de Ø600, Ø900 y Ø1150 mm.





ROFY 60



Características del producto

Cuerpo

Aluminio

Acabado

Pintado en epoxi-poliéster

Sistema óptico

gCONTROL+ - Difusor microprismático
LIGHT+ - Difusor opalino

Fuente de luz

LED, RG1, CRI>80, MacAdam Step ≤3

Vida útil del LED

80.000h @ L90, B10, Ta 25°C

Fuente de alimentación

Driver LED 220-240V-50/60Hz incluido



230V/50Hz



IP 40

K 04

650°C

01. Seleccionar versión



ROFY 60

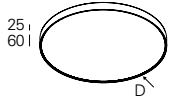

gCONTROL+ - Difusor microprismático

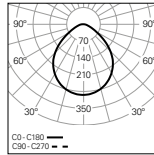

UGR	W	lm output	lm/W	Dmm	CÓDIGO*
≤22	16	1945	122	Ø300	90583L300▼▲◆0◆00
≤22	24	3085	129	Ø400	90583L400▼▲◆0◆00
≤19	43	5939	138	Ø600	90583L600▼▲◆0◆00
≤19	65	8844	136	Ø900	90583L900▼▲◆0◆00
≤19	107	14432	135	Ø1150	90583L115▼▲◆0◆00

LIGHT+ - Difusor opalino

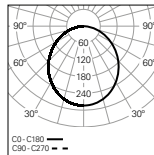

UGR	W	lm output	lm/W	Dmm	CÓDIGO*
≤22	16	2135	133	Ø300	90585L300▼▲◆0◆00
≤25	24	3385	141	Ø400	90585L400▼▲◆0◆00
≤22	43	6516	152	Ø600	90585L600▼▲◆0◆00
≤22	65	9704	149	Ø900	90585L900▼▲◆0◆00
≤22	107	15835	148	Ø1150	90585L115▼▲◆0◆00

*Sustituya los símbolos para completar el código

Fuente de alimentación ▼

HF	E
DALI	H

Color ¹ ▲

□ Blanco	W
■ Gris	G
■ Negro	B
■ Sahara	0
■ Mist	1
■ Carbon	I
■ Autumn	L
■ Rusty chain	R
■ Jungle	N
■ Golden eye	D
■ Old rose	5
■ Copper	7

ROFY 60

• Para la versión suspendida, es necesario pedir suspensiones, cable y base de alimentación por separado.

Emergencia ●

No EM	0
EM 3h (K3) ²	3

Temp. de color ◆

3000K	3
4000K	0
Tunable White ³	T

¹ Ver página 164.

² Preparado para telemando. Sólo disponible en las versiones de Ø600, Ø900 y Ø1150 mm.

³ No disponible en las versiones de Ø300 mm.

02. Seleccionar opciones

OPCIONES	Código*
Suspensión	
S10 L1500 mm (x3)	9111001
S10 L3000 mm (x3)	9111002
S10 L6000 mm (x3)	9111003

Cable de alimentación transparente	
L1500 mm - 3 x 0,75 mm ²	940400
L1500 mm - 5 x 0,75 mm ²	940500
L1500 mm - 7 x 0,75 mm ²	940600
L3000 mm - 3 x 0,75 mm ²	940401
L3000 mm - 5 x 0,75 mm ²	940501
L3000 mm - 7 x 0,75 mm ²	940601
L6000 mm - 3 x 0,75 mm ²	940402
L6000 mm - 5 x 0,75 mm ²	940507
L6000 mm - 7 x 0,75 mm ²	940602

• Para la opción DALI con kit de emergencia teledomable, es necesario solicitar 2 cables de alimentación de 5 x 0,75 mm².

Base circular		
Superficie T24	45 l  Ø95	978600♣
Superficie T26 (DALI+K3)		978601♣
Empotrar T5	 Ø70 33 l  Ø90	971300♣
Empotrar T27 (DALI+K3)		978700♣

Base de techo central		
Superficie T21	45 l  Ø95	977211♣
Superficie T28 (DALI+K3)		977230♣

Suspensión de varilla¹	
D95 - Ø400, Ø600 mm	913000♣
D120 - Ø900, Ø1150 mm	913010♣

• Base de alimentación incluida.

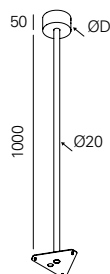

Versión de baja potencia
• Mediante solicitud.



*Sustituya los símbolos para completar el código

Color	
<input type="checkbox"/> Blanco	W
<input type="checkbox"/> Negro	B



Detalles del producto

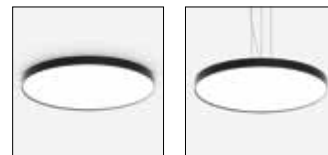

Aplicación de superficie

Aplicación suspendida

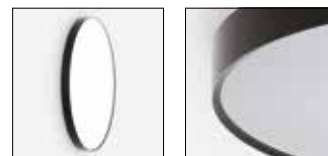

Aplicación de pared

Difusor gCONTROL+



Difusor LIGHT+

Suspensión paralela exterior

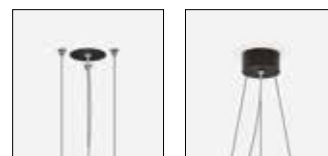

Suspensión paralela interior

Suspensión central exterior



Suspensión central interior

Suspensión de varilla

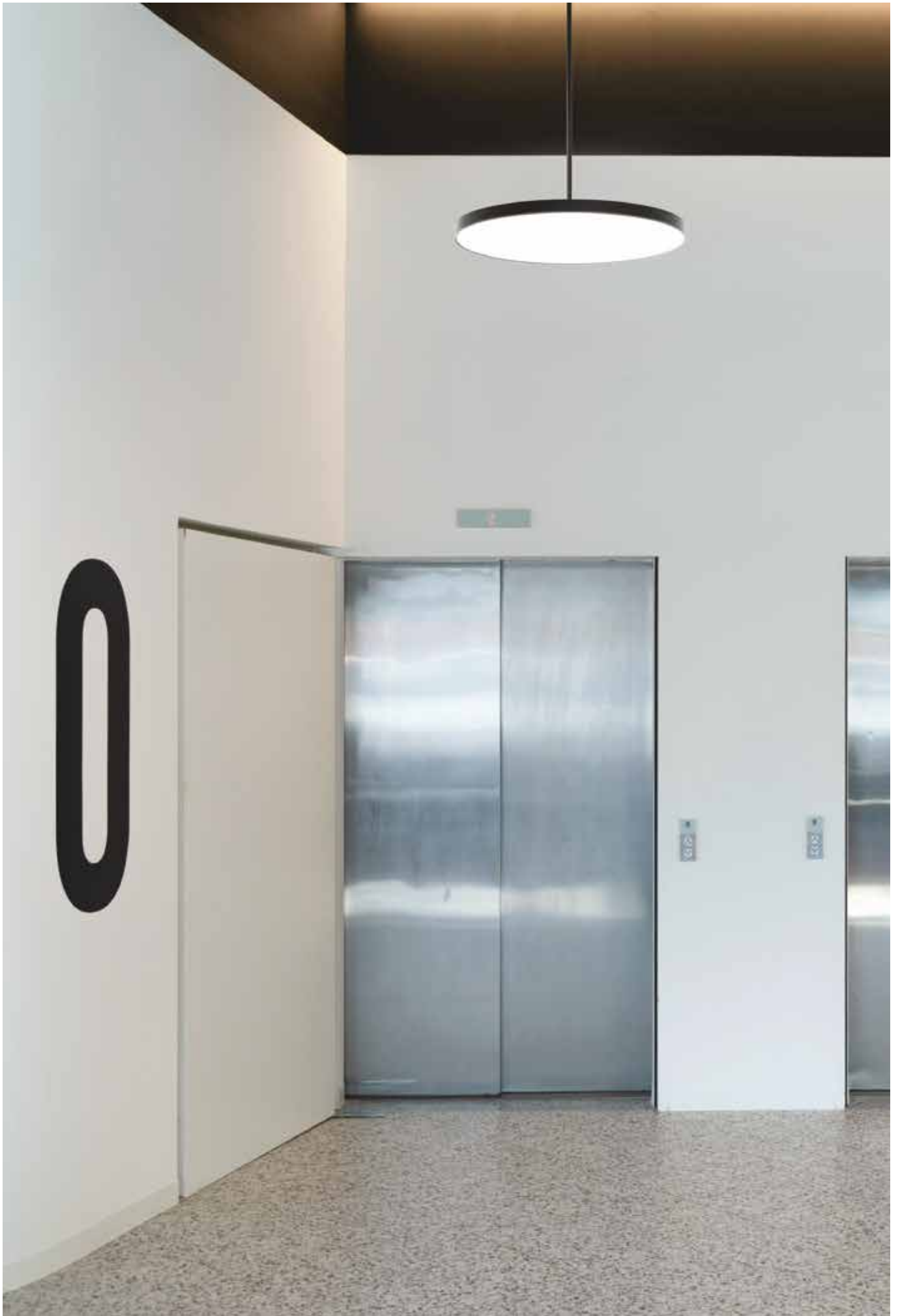

ROFY 60 D/I



Características del producto

Cuerpo

Aluminio

Acabado

Pintado en epoxi-poliéster

Sistema óptico

gCONTROL+ - Difusor microprismático
LIGHT+ - Difusor opalino

Fuente de luz

LED, RG1, CRI>80, MacAdam Step ≤3

Vida útil del LED

80.000h @ L90, B10, Ta 25°C

Fuente de alimentación

Driver LED 220-240V-50/60Hz incluido



230V/50Hz



IP 40

K 04

650°C

01. Seleccionar versión

ROFY 60 D/I

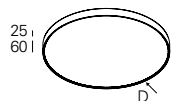

gCONTROL+ - Difusor microprismático (80%/20%)

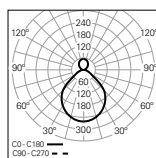

UGR	W	lm output	lm/W	Dmm	CÓDIGO*
≤19	32	3907	122	Ø400	90587L400♥♣♦00
≤19	56	7286	130	Ø600	90587L600♥♣♦♦00
≤19	84	10892	130	Ø900	90587L900♥♣♦♦00
≤19	137	17867	130	Ø1150	90587L115♥♣♦♦00

LIGHT+ - Difusor opalino (80%/20%)

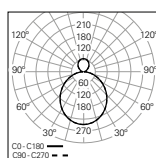

UGR	W	lm output	lm/W	Dmm	CÓDIGO*
≤22	32	4242	133	Ø400	90589L400♥♣♦♦00
≤22	56	7910	141	Ø600	90589L600♥♣♦♦00
≤22	84	11826	141	Ø900	90589L900♥♣♦♦00
≤22	137	19398	142	Ø1150	90589L115♥♣♦♦00

ROFY 60 D/I

- Para la versión suspendida, es necesario pedir suspensiones, cable y base de alimentación por separado.
- Para garantizar una total uniformidad luminica en el techo en la versión suspendida, la instalación debe realizarse a una distancia mínima de 500 mm.



*Sustituya los símbolos para completar el código

Fuente de alimentación	
HF	E
DALI	H
HF+CD ¹	Q
SWD+CD ²	Y

Color ³	
Blanco	W
Gris	G
Negro	B
Sahara	0
Mist	1
Carbon	I
Autumn	L
Rusty chain	R
Jungle	N
Golden eye	D
Old rose	5
Copper	7

Emergencia	
No EM	0
EM 3h (K3) ⁴	3

Temp. de color	
3000K	3
4000K	0
Tunable White	T

¹ HF + Doble circuito.

² SwitchDIM + Doble circuito.

³ Ver página 164.

⁴ Preparado para telemando. Sólo disponible en las versiones de Ø600, Ø900 y Ø1150 mm.

02. Seleccionar opciones

OPCIONES	Código*
Suspensión	
S10 L1500 mm (x3)	9111001
S10 L3000 mm (x3)	9111002
S10 L6000 mm (x3)	9111003

Cable de alimentación transparente	
L1500 mm - 3 x 0,75 mm ²	940400
L1500 mm - 5 x 0,75 mm ²	940500
L1500 mm - 7 x 0,75 mm ²	940600
L3000 mm - 3 x 0,75 mm ²	940401
L3000 mm - 5 x 0,75 mm ²	940501
L3000 mm - 7 x 0,75 mm ²	940601
L6000 mm - 3 x 0,75 mm ²	940402
L6000 mm - 5 x 0,75 mm ²	940507
L6000 mm - 7 x 0,75 mm ²	940602

• Para la opción DALI con kit de emergencia teledomable, es necesario solicitar 2 cables de alimentación de 5 x 0,75 mm².

Base circular		
Superficie T24	45 l  Ø95	978600♣
Superficie T26 (DALI+K3)		978601♣
Empotrar T5	 Ø70 33 l  Ø90	971300♣
Empotrar T27 (DALI+K3)		978700♣

Base de techo central		
Superficie T21	45 l  Ø95	977211♣
Superficie T28 (DALI+K3)		977230♣

Suspensión de varilla	
D95 - Ø400, Ø600 mm	913000♣
D120 - Ø900, Ø1150 mm	913010♣

• Base de alimentación incluida.

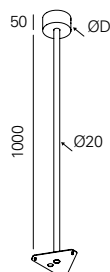

Versión de baja potencia

• Mediante solicitud.



*Sustituya los símbolos para completar el código

Color	
<input type="checkbox"/> Blanco	W
<input checked="" type="checkbox"/> Negro	B



Detalles del producto

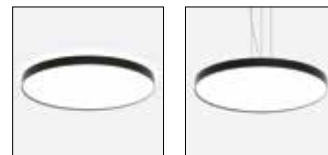

Aplicación de superficie

Aplicación suspendida

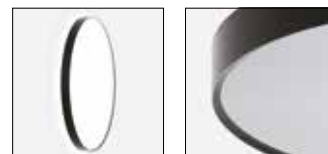

Aplicación de pared

Difusor gCONTROL+



Difusor LIGHT+

Luz indirecta



Suspensión paralela exterior

Suspensión paralela interior



Suspensión central exterior

Suspensión central interior



Suspensión de varilla

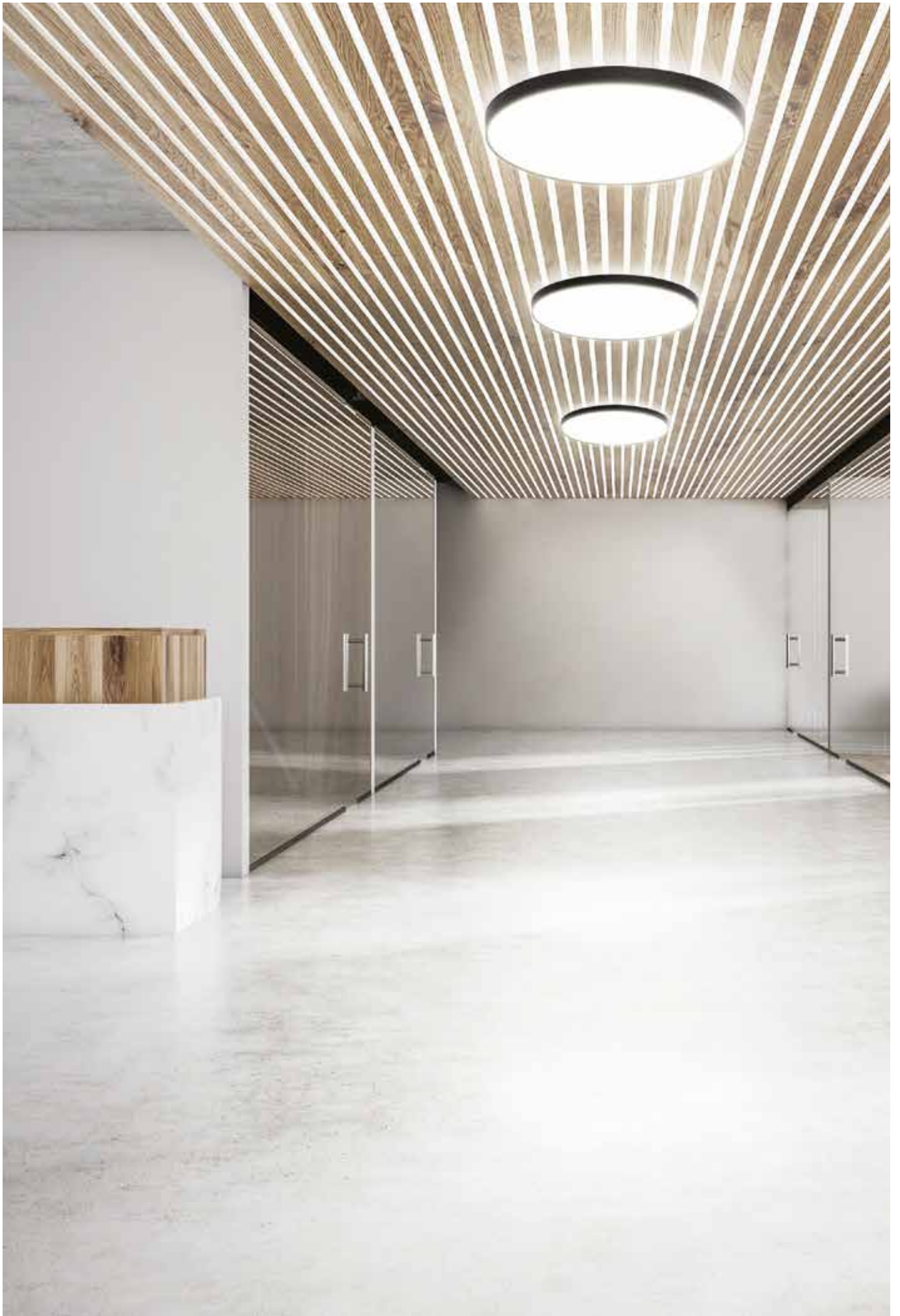

ROFY 85 /E



Características del producto

Cuerpo

Aluminio

Acabado

Pintado en epoxi-poliéster

Sistema óptico

gCONTROL+ - Difusor microprismático
LIGHT+ - Difusor opalino

Fuente de luz

LED, RG1, CRI>80, MacAdam Step ≤3

Vida útil del LED

80.000h @ L90, B10, Ta 25°C

Fuente de alimentación

Driver LED 220-240V-50/60Hz incluido

Espesor del techo

Para techos entre 1-25 mm

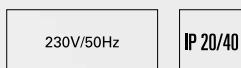

01. Seleccionar versión

ROFY 85 /E



gCONTROL+ - Difusor microprismático

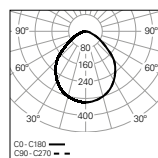

UGR	W	lm output	lm/W	Dmm	Ømm	CÓDIGO*
≤19	16	1810	113	Ø300	Ø286	90622L300▼▲◆0◆00
≤19	24	2871	120	Ø400	Ø386	90622L400▼▲◆0◆00
≤19	43	5526	129	Ø600	Ø586	90622L600▼▲◆0◆00
≤19	65	8230	127	Ø900	Ø886	90622L900▼▲◆0◆00
≤19	107	13429	126	Ø1150	Ø1136	90622L115▼▲◆0◆00

LIGHT+ - Difusor opalino

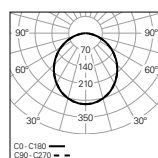

UGR	W	lm output	lm/W	Dmm	Ømm	CÓDIGO*
≤25	16	2135	133	Ø300	Ø286	90621L300▼▲◆0◆00
≤25	24	3385	141	Ø400	Ø386	90621L400▼▲◆0◆00
≤22	43	6516	152	Ø600	Ø586	90621L600▼▲◆0◆00
≤22	65	9704	149	Ø900	Ø886	90621L900▼▲◆0◆00
≤22	107	15835	148	Ø1150	Ø1136	90621L115▼▲◆0◆00

ROFY 85 /E

• Este producto no se puede aplicar a la pared.



*Sustituya los símbolos para completar el código

Fuente de alimentación ▼
 HF E
 DALI H

Color ¹ ▲
 □ Blanco W
 ■ Gris G
 ■ Negro B
 ■ Sahara 0
 ■ Mist 1
 ■ Carbon I
 ■ Autumn L
 ■ Rusty chain R
 ■ Jungle N
 ■ Golden eye D

Emergencia ●
 No EM 0
 EM 3h (K3) ² 3

Temp. de color ◆
 3000K 3
 4000K 0
 Tunable White ³ T

02. Seleccionar opciones

OPCIONES	Código
Cable de seguridad en acero	955000
Versión de baja potencia	
• Mediante solicitud.	



Detalles del producto

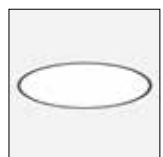

Aplicación de empotrar



Difusor gCONTROL+



Difusor LIGHT+

¹ Ver página 164.

² Preparado para teledmando. Sólo disponible en las versiones de Ø600, Ø900 y Ø1150 mm.

³ No disponible en la versión de Ø300 mm.

ROFY 85



Características del producto

Cuerpo

Aluminio

Acabado

Pintado en epoxi-poliéster

Sistema óptico

gCONTROL+ - Difusor microprismático
LIGHT+ - Difusor opalino

Fuente de luz

LED, RG1, CRI>80, MacAdam Step ≤3

Vida útil del LED

80.000h @ L90, B10, Ta 25°C

Fuente de alimentación

Driver LED 220-240V-50/60Hz incluido



230V/50Hz



IP 40

K 04

650°C

01. Seleccionar versión

ROFY 85

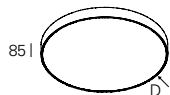

gCONTROL+ - Difusor microprismático

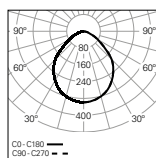

UGR	W	lm output	lm/W	Dmm	CÓDIGO*
≤22	16	1999	125	Ø300	90620L300▼▲◆00
≤22	24	3171	132	Ø400	90620L400▼▲◆00
≤19	43	6104	142	Ø600	90620L600▼▲◆00
≤19	65	9090	140	Ø900	90620L900▼▲◆00
≤19	107	14833	139	Ø1150	90620L115▼▲◆00

LIGHT+ - Difusor opalino

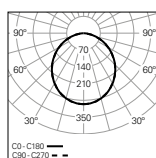

UGR	W	lm output	lm/W	Dmm	CÓDIGO*
≤25	16	2162	135	Ø300	90619L300▼▲◆00
≤25	24	3428	143	Ø400	90619L400▼▲◆00
≤22	43	6598	153	Ø600	90619L600▼▲◆00
≤22	65	9827	151	Ø900	90619L900▼▲◆00
≤22	107	16035	150	Ø1150	90619L115▼▲◆00

ROFY 85

• Para la versión suspendida, es necesario pedir suspensiones, cable y base de alimentación por separado.



*Sustituya los símbolos para completar el código

Fuente de alimentación ▼

HF E
DALI H

Color ¹ ▲

□ Blanco W
■ Gris G
■ Negro B
■ Sahara 0
■ Mist 1
■ Carbon I
■ Autumn L
■ Rusty chain R
■ Jungle N
■ Golden eye D

Emergencia ●

No EM 0
EM 3h (K3) ² 3

Temp. de color ◆

3000K 3
4000K 0
Tunable White ³ T

¹ Ver página 164.

² Preparado para telemando. Sólo disponible en las versiones de Ø600, Ø900 y Ø1150 mm.

³ No disponible en la versión de Ø300 mm.

02. Seleccionar opciones

OPCIONES	Código*
Suspensión	
S10 L1500 mm (x3)	9111001
S10 L3000 mm (x3)	9111002
S10 L6000 mm (x3)	9111003

Cable de alimentación transparente	
L1500 mm - 3 x 0,75 mm ²	940400
L1500 mm - 5 x 0,75 mm ²	940500
L1500 mm - 7 x 0,75 mm ²	940600
L3000 mm - 3 x 0,75 mm ²	940401
L3000 mm - 5 x 0,75 mm ²	940501
L3000 mm - 7 x 0,75 mm ²	940601
L6000 mm - 3 x 0,75 mm ²	940402
L6000 mm - 5 x 0,75 mm ²	940507
L6000 mm - 7 x 0,75 mm ²	940602

• Para la opción DALI con kit de emergencia teledomable, es necesario solicitar 2 cables de alimentación de 5 x 0,75 mm².

Base circular		
Superficie T24	45 l  Ø95	978600♣
Superficie T26 (DALI+K3)		978601♣
Empotrar T5	 Ø70 33 l  Ø90	971300♣
Empotrar T27 (DALI+K3)		978700♣

Base de techo central		
Superficie T21	45 l  Ø95	977211♣
Superficie T28 (DALI+K3)		977230♣

Suspensión de varilla	
D95 - Ø400, Ø600 mm	913000♣
D120 - Ø900, Ø1150 mm	913010♣

• Base de alimentación incluida.

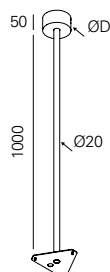

Versión de baja potencia
• Mediante solicitud.



*Sustituya los símbolos para completar el código

Color ♣
 Blanco W
 Negro B



Detalles del producto



Aplicación de superficie



Aplicación suspendida



Aplicación de pared



Difusor gCONTROL+



Difusor LIGHT+



Suspensión paralela exterior

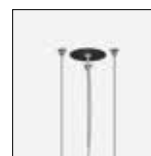

Suspensión paralela interior



Suspensión central exterior



Suspensión central interior



Suspensión de varilla



ROFY 85 D/I



Características del productos

Cuerpo

Aluminio

Acabado

Pintado en epoxi-poliéster

Sistema óptico

gCONTROL+ - Difusor microprismático
LIGHT+ - Difusor opalino

Fuente de luz

LED, RG1, CRI>80, MacAdam Step ≤3

Vida útil del LED

80.000h @ L90, B10, Ta 25°C

Fuente de alimentación

Driver LED 220-240V-50/60Hz incluido



230V/50Hz



IP 40

K 04

650°C

01. Seleccionar versión



ROFY 85 D/I

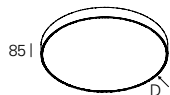

gCONTROL+ - Difusor microprismático (80%/20%)

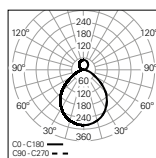

UGR	W	lm output	lm/W	Dmm	CÓDIGO*
≤19	32	4018	126	Ø400	90624L400♥♣♦00
≤19	56	7494	134	Ø600	90624L600♥♣♦♦00
≤19	84	11203	133	Ø900	90624L900♥♣♦♦00
≤19	137	18377	134	Ø1150	90624L115♥♣♦♦00

LIGHT+ - Difusor opalino (80%/20%)

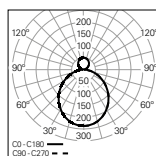

UGR	W	lm output	lm/W	Dmm	CÓDIGO*
≤22	32	4242	133	Ø400	90623L400♥♣♦♦00
≤22	56	7910	141	Ø600	90623L600♥♣♦♦00
≤22	84	11826	141	Ø900	90623L900♥♣♦♦00
≤22	137	19398	142	Ø1150	90623L115♥♣♦♦00

ROFY 85 D/I

- Para completar el producto es necesario pedir la suspensión, el cable y la base de alimentación por separado.
- Para garantizar una uniformidad total de la luz en el techo, la instalación debe realizarse con una distancia mínima de 500 mm.

*Sustituya los símbolos para completar el código

Fuente de alimentación	
HF	E
DALI	H
HF+CD ¹	Q
SWD+CD ²	Y

Color ³	
Blanco	W
Gris	G
Negro	B
Sahara	0
Mist	1
Carbon	I
Autumn	L
Rusty chain	R
Jungle	N
Golden eye	D

Emergencia	
No EM	0
EM 3h (K3) ⁴	3

Temp. de color	
3000K	3
4000K	0
Tunable White	T

¹ HF + Doble circuito.

² SwitchDIM + Doble circuito.

³ Ver página 164.



⁴ Preparado para telemando. Sólo disponible en las versiones de Ø600, Ø900 y Ø1150 mm.

02. Seleccionar opciones

OPCIONES	Código*
Suspensión	
S10 L1500 mm (x3)	9111001
S10 L3000 mm (x3)	9111002
S10 L6000 mm (x3)	9111003

Cable de alimentación transparente	
L1500 mm - 3 x 0,75 mm ²	940400
L1500 mm - 5 x 0,75 mm ²	940500
L1500 mm - 7 x 0,75 mm ²	940600
L3000 mm - 3 x 0,75 mm ²	940401
L3000 mm - 5 x 0,75 mm ²	940501
L3000 mm - 7 x 0,75 mm ²	940601
L6000 mm - 3 x 0,75 mm ²	940402
L6000 mm - 5 x 0,75 mm ²	940507
L6000 mm - 7 x 0,75 mm ²	940602

• Para la opción DALI con kit de emergencia teledomable, es necesario solicitar 2 cables de alimentación de 5 x 0,75 mm².

Base circular			
Superficie T24	45 l  Ø95	978600♣	
Superficie T26 (DALI+K3)		978601♣	
Empotrar T5	 Ø70	33 l  Ø90	971300♣
Empotrar T27 (DALI+K3)		978700♣	

Base de techo central		
Superficie T21	45 l  Ø95	977211♣
Superficie T28 (DALI+K3)		977230♣

Suspensión de varilla	
D95 - Ø400, Ø600 mm	913000♣
D120 - Ø900, Ø1150 mm	913010♣

• Base de alimentación incluida.

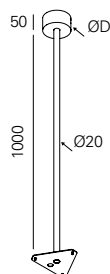

Versión de baja potencia
• Mediante solicitud.



*Sustituya los símbolos para completar el código

Color	
<input type="checkbox"/> Blanco	W
<input checked="" type="checkbox"/> Negro	B



Detalles del producto



Aplicación suspendida

Luz indirecta



Difusor gCONTROL+

Difusor LIGHT+

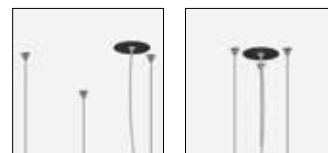

Suspensión paralela exterior

Suspensión paralela interior



Suspensión central exterior

Suspensión central interior



Suspensión de varilla

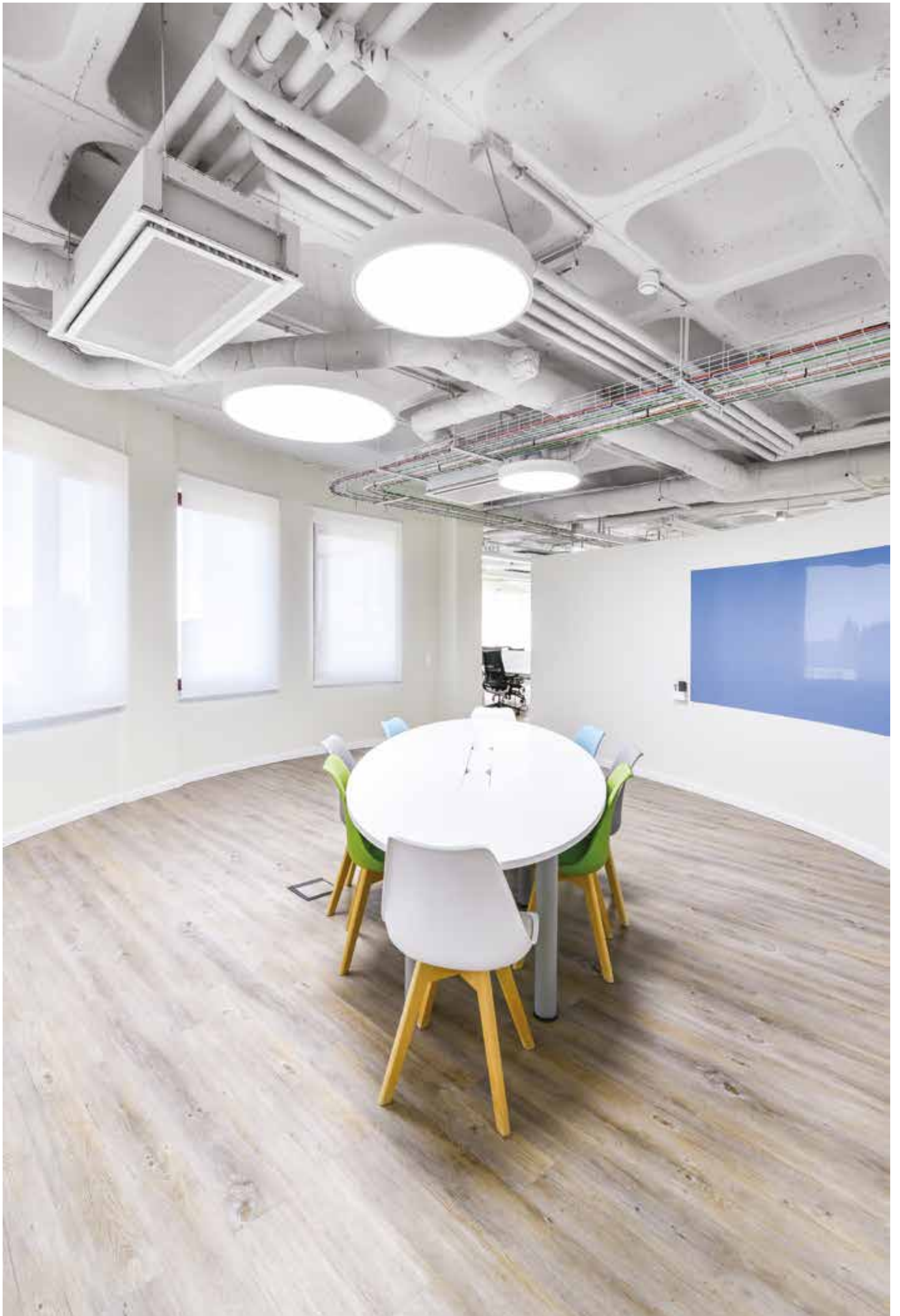

ROFY 85 IP /E



Características del productos

Cuerpo

Aluminio

Acabado

Pintado en epoxi-poliéster

Sistema óptico

LIGHT+ - Difusor opalino

Fuente de luz

LED, RG1, CRI>80, MacAdam Step ≤3

Vida útil del LED

80.000h @ L90, B10, Ta 25°C

Fuente de alimentación

Driver LED 220-240V-50/60Hz incluido

Espesor del techo

Para techos entre 1-35 mm

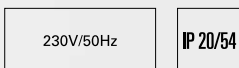

01. Seleccionar versión

ROFY 85 IP / E

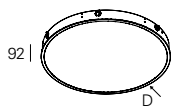

LIGHT+ - Difusor opalino

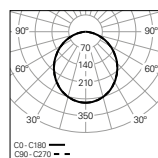

W	lm output	lm/W	Dmm	Ø	CÓDIGO*
16	2135	133	Ø323	Ø305	90573L300▼▲◆0◆00
24	3385	141	Ø423	Ø405	90573L400▼▲◆0◆00
43	6516	152	Ø623	Ø605	90573L600▼▲◆0◆00

ROFY 85 IP / E

- Este producto no se puede aplicar a la pared.



*Sustituya los símbolos para completar el código

Fuente de alimentación	
HF	E
DALI	H

Color ¹

Blanco	W
Gris	G
Negro	B
Sahara	0
Mist	1
Carbon	I
Autumn	L
Rusty chain	R
Jungle	N
Golden eye	D

Emergencia ²

No EM	0
EM 3h (K3) ²	3

Temp. de color ³

3000K	3
4000K	0
Tunable White ³	T

02. Seleccionar opciones

OPCIONES Código

Cable de seguridad en acero
L1500 mm 955000

Versión de baja potencia

- Mediante solicitud.



Detalles del producto

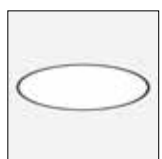

Aplicación de empotrar



Difusor LIGHT+

¹ Ver página 164.

² Preparado para telemando. Sólo disponible en la versión Ø600 mm.

³ No disponible en las versiones de Ø300 mm.

ROFY 85 IP /C



Características del productos

Cuerpo

Aluminio

Acabado

Pintado en epoxi-poliéster

Sistema óptico

LIGHT+ - Difusor opalino

Fuente de luz

LED, RG1, CRI>80, MacAdam Step ≤3

Vida útil del LED

80.000h @ L90, B10, Ta 25°C

Fuente de alimentación

Driver LED 220-240V-50/60Hz incluido

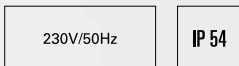

01. Seleccionar versión

ROFY 85 IP /C

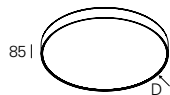

LIGHT+ - Difusor opalino

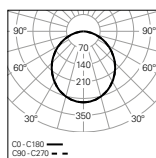

W	lm output	lm/W	Dmm	CÓDIGO*
16	2135	133	Ø300	90581L300♥♣♦00
24	3385	141	Ø400	90581L400♥♣♦00
43	6516	152	Ø600	90581L600♥♣♦00



*Sustituya los símbolos para completar el código

Fuente de alimentación	
HF	E
DALI	H

Color ¹	
Blanco	W
Gris	G
Negro	B
Sahara	0
Mist	1
Carbon	I
Autumn	L
Rusty chain	R
Jungle	N
Golden eye	D

Emergencia	
No EM	0
EM 3h (K3) ²	3

Temp. de color	
3000K	3
4000K	0
Tunable White ³	T

02. Seleccionar opciones

OPCIONES

Versión de baja potencia

- Mediante solicitud.



Detalles del producto



Aplicación de superficie



Aplicación de pared



Difusor LIGHT+



Protection IP54

¹ Ver página 164.

² Preparado para telemando. Sólo disponible en la versión Ø600 mm.

³ No disponible en las versiones de Ø300 mm.





RECEPTION



ROFY 60 SQ



ROFY 60 Sq
198



ROFY 60 Sq D/I
202



ROFY 60 Sq



Características del productos

Cuerpo

Aluminio

Acabado

Pintado en epoxi-poliéster

Sistema óptico

gCONTROL+ - Difusor microprismático
LIGHT+ - Difusor opalino

Fuente de luz

LED, RG1, CRI>80, MacAdam Step ≤3

Vida útil del LED

80.000h @ L90, B10, Ta 25°C

Fuente de alimentación

Driver LED 220-240V-50/60Hz incluido



230V/50Hz



IP 40

K 04

650°C

01. Seleccionar versión

ROFY 60 Sq

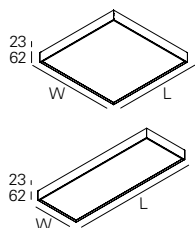

gCONTROL+ - Difusor microprismático

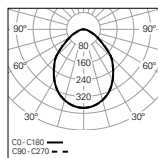

UGR	W	lm output	lm/W	LxWmm	CÓDIGO*
≤19	12	1478	123	286x286	90718L286▼▲0◆00
≤19	45	5913	131	550x550	90718L550▼▲◆000
≤19	25	2956	118	550x286	90718L552▼▲0◆00
≤19	36	4435	123	814x286	90718L812▼▲◆000
≤19	45	5913	131	1078x286	90718L102▼▲◆000
≤19	56	7391	132	1342x286	90718L132▼▲◆000

LIGHT+ - Difusor opalino

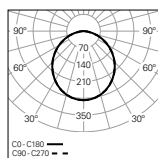

UGR	W	lm output	lm/W	LxWmm	CÓDIGO*
≤22	12	1582	132	286x286	90720L286▼▲0◆00
≤22	45	6329	141	550x550	90720L550▼▲◆000
≤22	25	3165	127	550x286	90720L552▼▲0◆00
≤22	36	4747	132	814x286	90720L812▼▲◆000
≤22	45	6329	141	1078x286	90720L102▼▲◆000
≤22	56	7912	141	1342x286	90720L132▼▲◆000

ROFY 60 Sq

• Para la versión suspendida, es necesario pedir suspensiones, cable y base de alimentación por separado.



*Sustituya los símbolos para completar el código

Fuente de alimentación ▼

HF	E
DALI	H

Color ¹ ▲

□ Blanco	W
■ Gris	G
■ Negro	B
■ Sahara	0
■ Mist	1
■ Carbon	I
■ Autumn	L
■ Rusty chain	R
■ Jungle	N
■ Golden eye	D

Emergencia ●

No EM	0
EM 3h (K3) ²	3





Temp. de color ◆

3000K	3
4000K	0
Tunable White	T

¹ Ver página 164.

² Preparado para telemando. Sólo disponible en las versiones de L550x550, L814, L1078 y L1342 mm.

02. Seleccionar opciones

OPCIONES	Código*
Suspensión	
S11 L1500 mm (x4)	9129041
S11 L3000 mm (x4)	9129042
S11 L6000 mm (x4)	9129043
Cable de alimentación transparente	
L1500 mm - 3 x 0,75 mm ²	940400
L1500 mm - 5 x 0,75 mm ²	940500
L1500 mm - 7 x 0,75 mm ²	940600
L3000 mm - 3 x 0,75 mm ²	940401
L3000 mm - 5 x 0,75 mm ²	940501
L3000 mm - 7 x 0,75 mm ²	940601
L6000 mm - 3 x 0,75 mm ²	940402
L6000 mm - 5 x 0,75 mm ²	940507
L6000 mm - 7 x 0,75 mm ²	940602
<ul style="list-style-type: none"> • Para la opción DALI con kit de emergencia teledomable, es necesario solicitar 2 cables de alimentación de 5 x 0,75 mm². 	
Base de techo	
Superficie T25  45  100	978610♣
Superficie T29 (DALI+K3)	978611♣
Empotrar T7  Ø70 35  90	971400♣
Empotrar T59 (DALI+K3)	971410♣
Versión de baja potencia	
<ul style="list-style-type: none"> • Mediante solicitud. 	



*Sustituya los símbolos para completar el código

Color 

Blanco W

Negro B



Detalles del producto

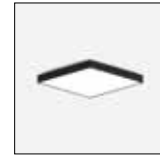

Aplicación de superficie

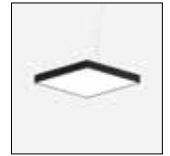

Aplicación suspendida

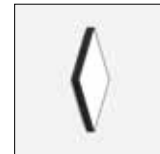

Aplicación de pared



Difusor gCONTROL+



Difusor LIGHT+



Suspensión paralela exterior



Bases de techo

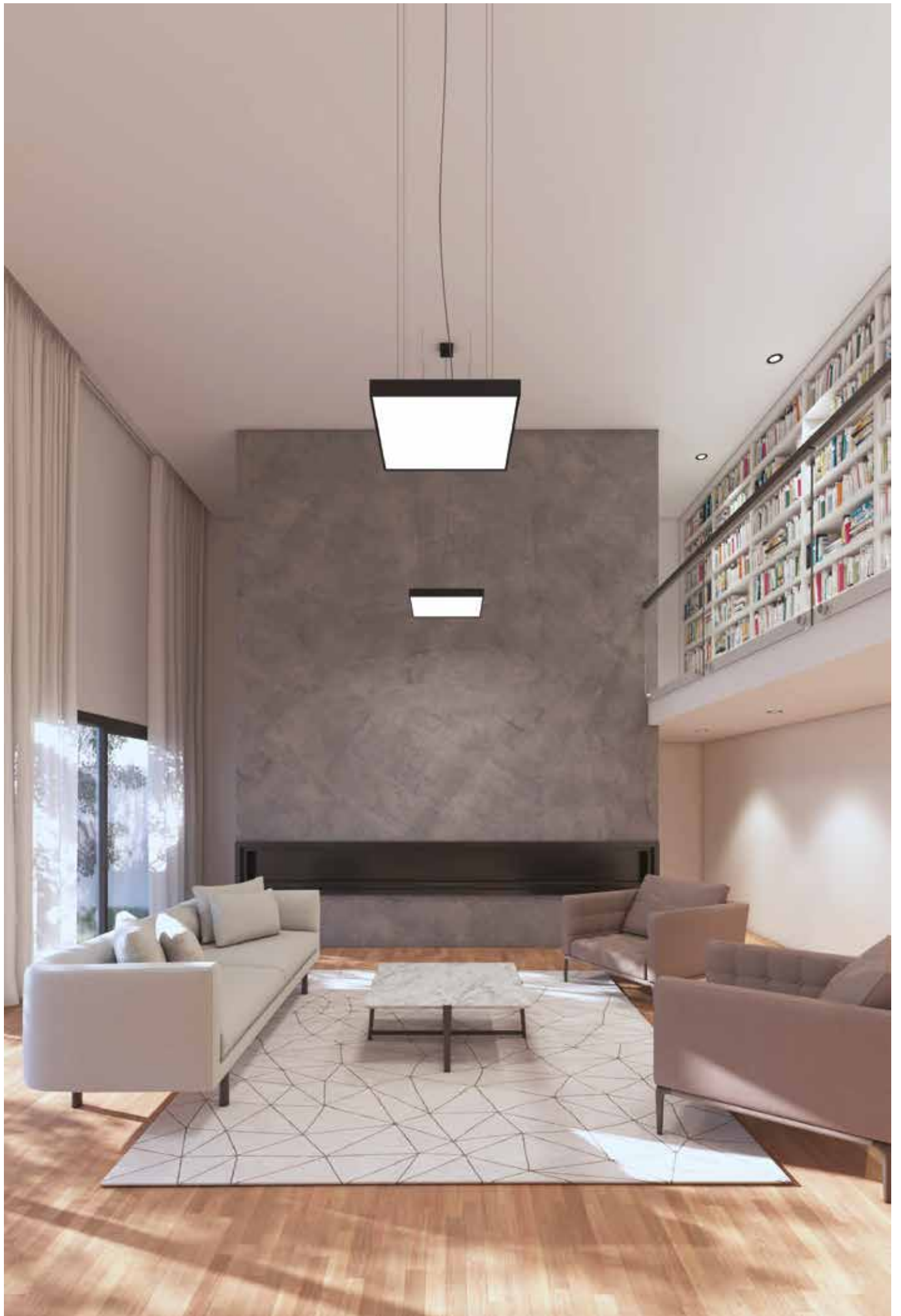

ROFY 60 Sq D/I



Características del productos

Cuerpo

Aluminio

Acabado

Pintado en epoxi-poliéster

Sistema óptico

gCONTROL+ - Difusor microprismático
LIGHT+ - Difusor opalino

Fuente de luz

LED, RG1, CRI>80, MacAdam Step ≤3

Vida útil del LED

80.000h @ L90, B10, Ta 25°C

Fuente de alimentación

Driver LED 220-240V-50/60Hz incluido



230V/50Hz



IP 40

K 04

650°C

01. Seleccionar versión

ROFY 60 Sq D/I

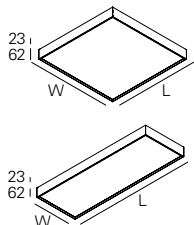

gCONTROL+ - Difusor microprismático (75%/25%)

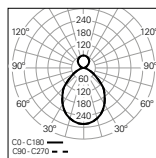

UGR	W	lm output	lm/W	LxWmm	CÓDIGO*
≤16	18	2231	124	286x286	90714L286♥♣♦00
≤19	60	7753	129	550x550	90714L550♥♣♦♦00
≤19	33	3967	120	550x286	90714L552♥♣♦000
≤19	48	5963	124	814x286	90714L812♥♣♦♦00
≤19	60	7935	132	1078x286	90714L102♥♣♦♦00
≤19	75	9912	132	1342x286	90714L132♥♣♦♦00

LIGHT+ - Difusor opalino (75%/25%)

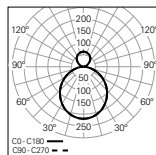

UGR	W	lm output	lm/W	LxWmm	CÓDIGO*
≤22	18	2325	129	286x286	90716L286♥♣♦000
≤22	60	8081	135	550x550	90716L550♥♣♦♦00
≤22	33	4135	125	550x286	90716L552♥♣♦000
≤22	48	6215	129	814x286	90716L812♥♣♦♦00
≤22	60	8270	138	1078x286	90716L102♥♣♦♦00
≤22	75	10330	138	1342x286	90716L132♥♣♦♦00

ROFY 60 Sq D/I

- Para la versión suspendida, es necesario pedir suspensiones, cable y base de alimentación por separado.
- Para garantizar una total uniformidad luminica en el techo en la versión suspendida, la instalación debe realizarse a una distancia mínima de 500 mm.



*Sustituya los símbolos para completar el código

Fuente de alimentación	
HF	E
DALI	H
HF+CD ¹	Q
SWD+CD ²	Y

Color ³	
Blanco	W
Gris	G
Negro	B
Sahara	0
Mist	1
Carbon	I
Autumn	L
Rusty chain	R
Jungle	N
Golden eye	D

Emergencia	
No EM	0
EM 3h (K3) ⁴	3

Temp. de color	
3000K	3
4000K	0
Tunable White	T





¹ HF + Doble circuito.

² SwitchDIM + Doble circuito.

³ Ver página 164.

⁴ Preparado para telemando. Sólo disponible en las versiones de L550x550, L814, L1078 y L1342 mm

02. Seleccionar opciones

OPCIONES	Código*
Suspensión	
S11 L1500 mm (x4)	9129041
S11 L3000 mm (x4)	9129042
S11 L6000 mm (x4)	9129043
Cable de alimentación transparente	
L1500 mm - 3 x 0,75 mm ²	940400
L1500 mm - 5 x 0,75 mm ²	940500
L1500 mm - 7 x 0,75 mm ²	940600
L3000 mm - 3 x 0,75 mm ²	940401
L3000 mm - 5 x 0,75 mm ²	940501
L3000 mm - 7 x 0,75 mm ²	940601
L6000 mm - 3 x 0,75 mm ²	940402
L6000 mm - 5 x 0,75 mm ²	940507
L6000 mm - 7 x 0,75 mm ²	940602
<ul style="list-style-type: none"> • Para la opción DALI con kit de emergencia teledomable, es necesario solicitar 2 cables de alimentación de 5 x 0,75 mm². 	
Base de techo	
Superficie T25  45  100	978610♣
Superficie T29 (DALI+K3)	978611♣
Empotrar T7  Ø70 35  90	971400♣
Empotrar T59 (DALI+K3)	971410♣
Versión de baja potencia	
<ul style="list-style-type: none"> • Mediante solicitud. 	



*Sustituya los símbolos para completar el código

Color 
 Blanco W
 Negro B



Detalles del producto

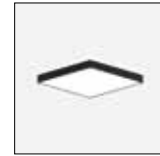

Aplicación de superficie

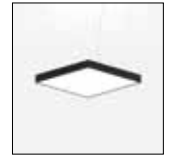

Aplicación suspendida

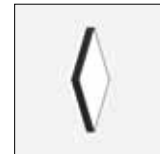

Aplicación de pared



Luz indirecta



Difusor gCONTROL+



Difusor LIGHT+



Suspensión paralela exterior



Bases de techo





OREO



OREO /C
214



OREO In
216



OREO Out
220



OREO V In
224



OREO V Out
228



OREO Linea Down
232



OREO Linea Up
236



Tipos de aplicación

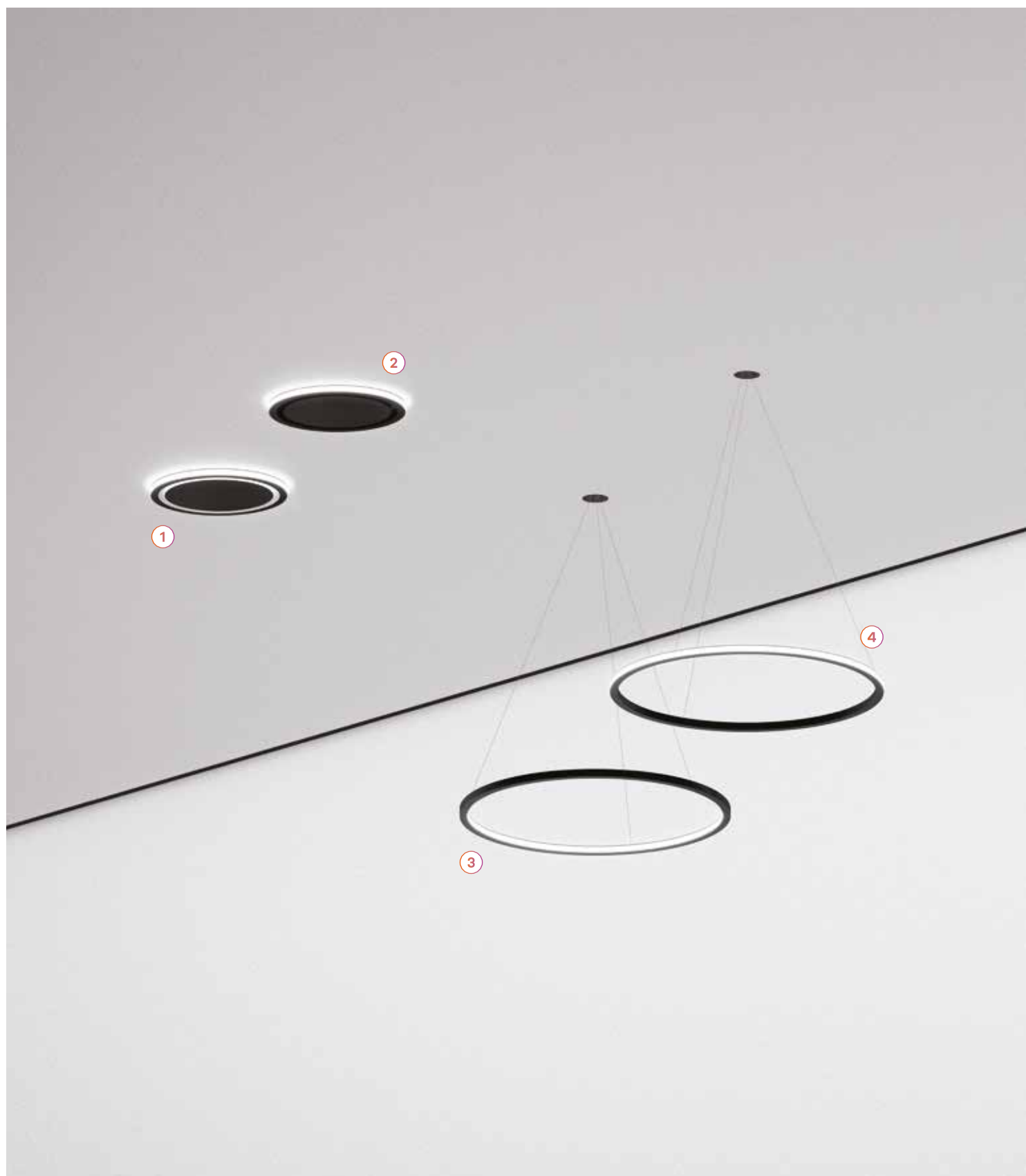

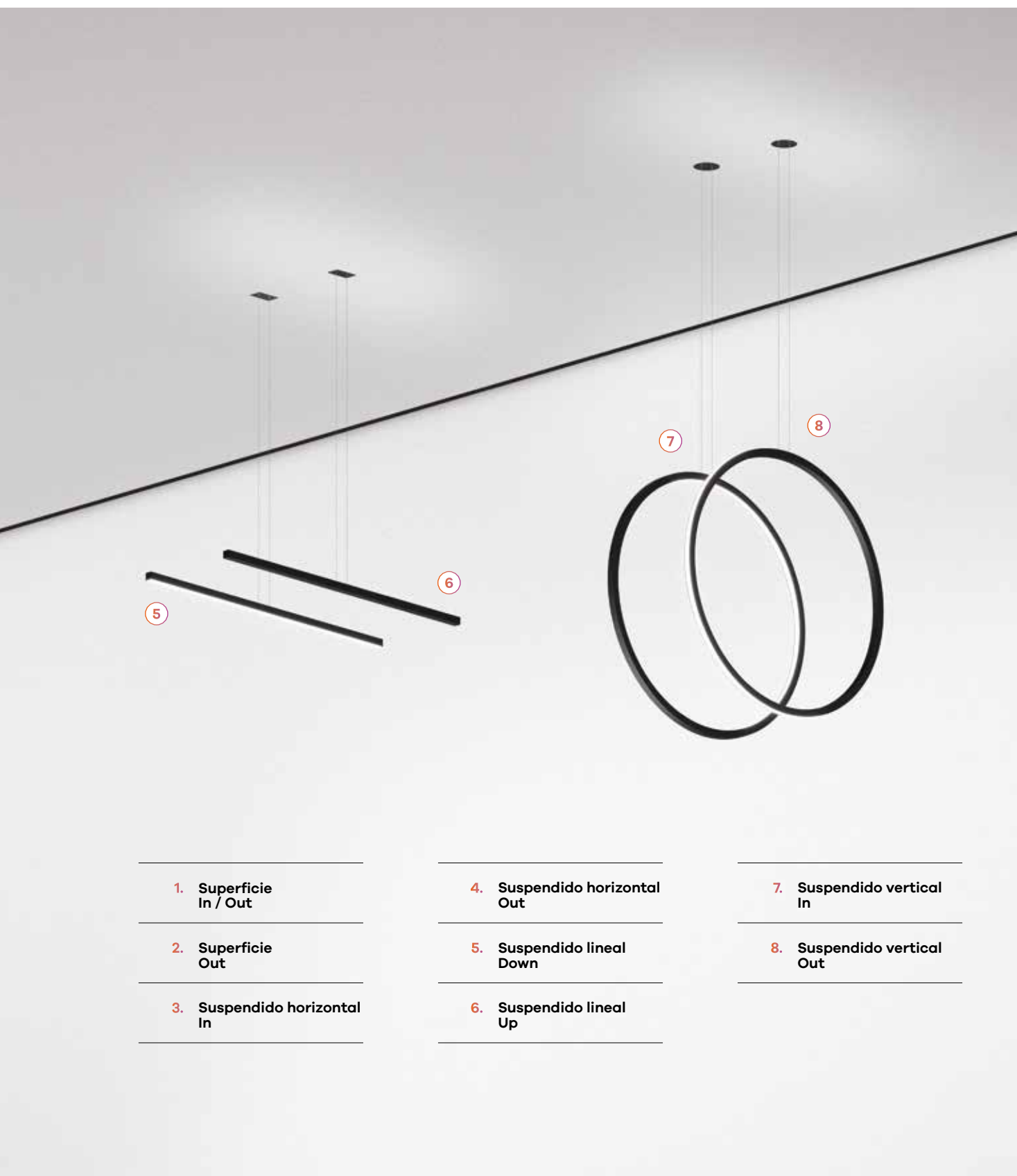

-
- 1. Superficie In / Out
-
- 2. Superficie Out
-
- 3. Suspendido horizontal In
-

-
- 4. Suspendido horizontal Out
-
- 5. Suspendido lineal Down
-
- 6. Suspendido lineal Up
-

-
- 7. Suspendido vertical In
-
- 8. Suspendido vertical Out
-

Minimalismo y tecnología

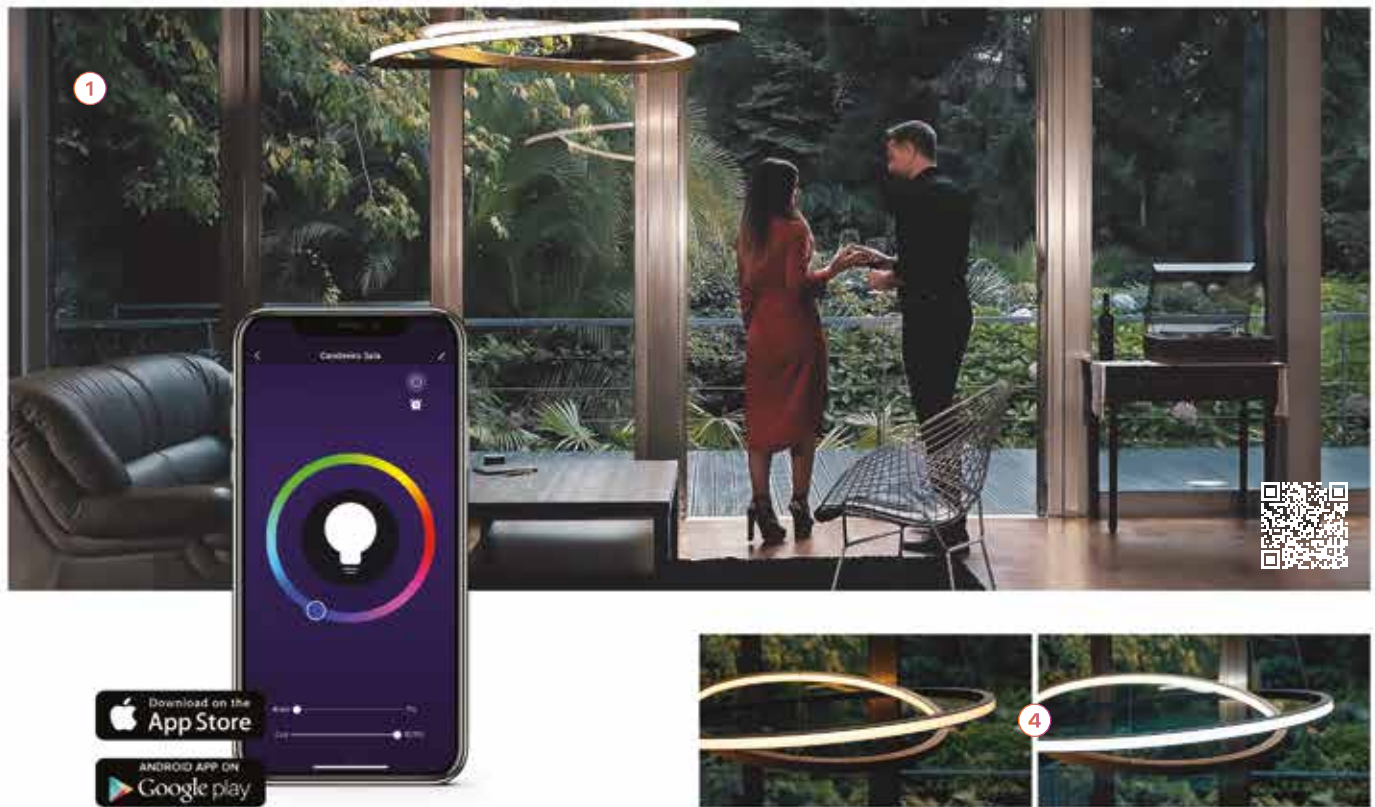

1. OmniaControl (VOICE & APP Tuya Smart)

Utilizando el módulo OmniaControl instalado en las luminarias y utilizando dispositivos de control por voz de Amazon Echo, Google Home o la aplicación Tuya Smart, podrás controlar toda la iluminación LED inteligente de tu hogar/oficina.

2. Cuerpo

Perfil de aluminio soldado sin marcas, disponible en 12 colores.

3. LED

SDCM MacAdam ≤ 3 , temperatura de color 2700K / 3000K / 4000K, CRI > 90 y vida útil de 60.000h L80 B10.

4. Tunable White y RGB White

Versiones Tunable White disponibles con un espectro de blancos de 3000K a 5700K. También están disponibles versiones RGB White.

5. bLINE

Sistema óptico bLINE con tecnología clip-in que garantiza una luz suave y uniforme sin puntos visibles.

6. Las suspensiones son el cable de alimentación

Las suspensiones de 1500 mm funcionan como cable de alimentación, creando un aspecto más limpio para tu espacio.

7. Base de techo

Base de techo en versión sin marco (trimless), empotrada o de superficie disponibles en blanco o negro.

Sistema óptico

ILUMINACIÓN
ARQUITECTÓNICA

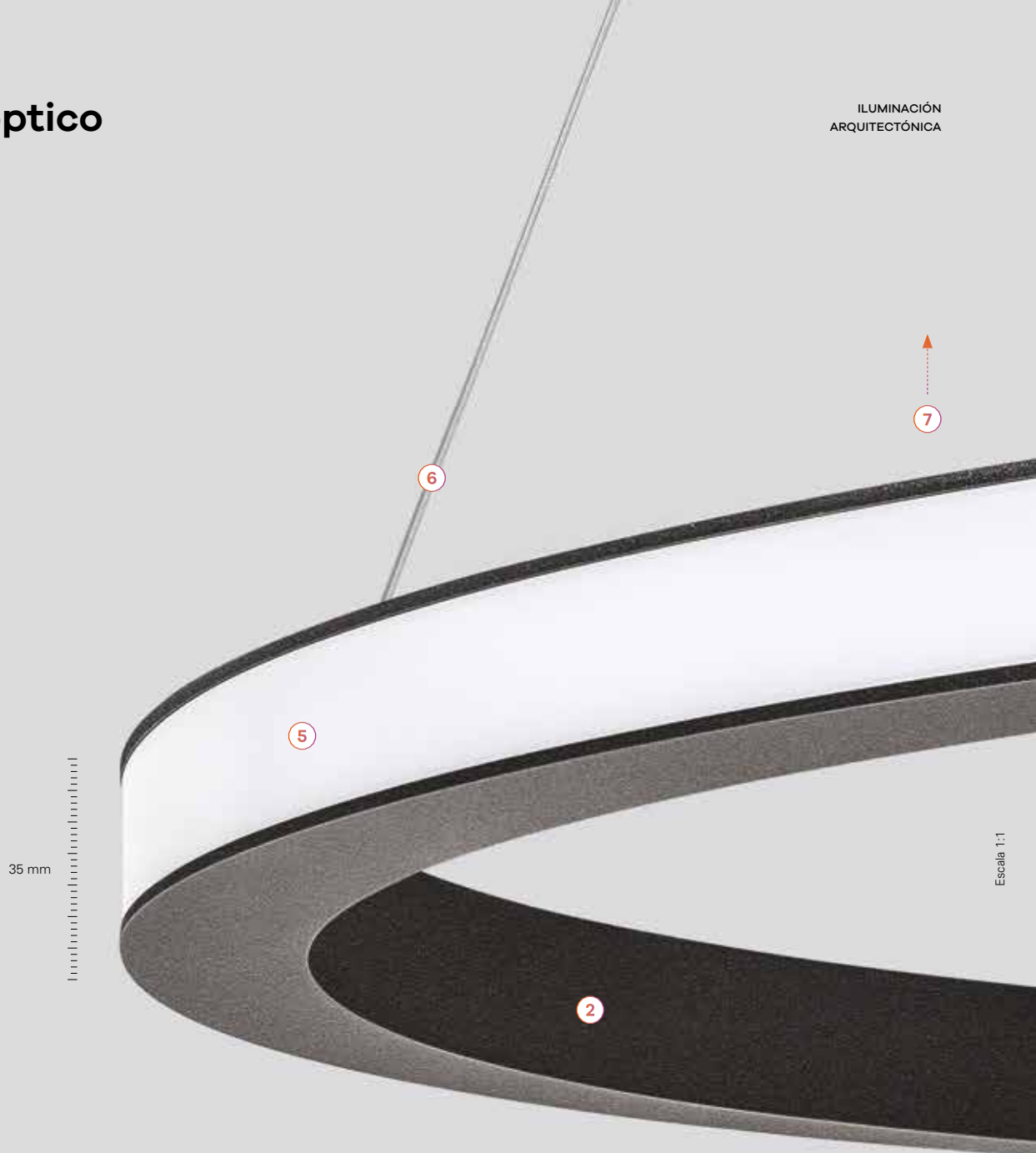

5. bLINE

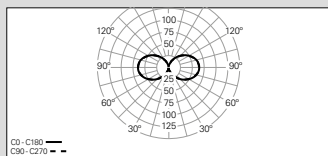

Defina su color

ILUMINACIÓN
ARQUITECTÓNICA

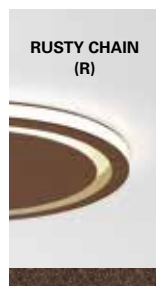
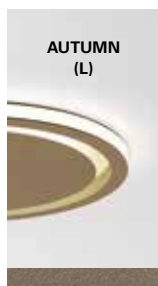
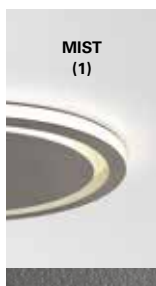
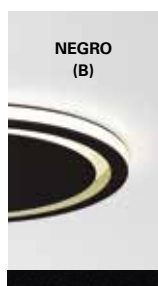

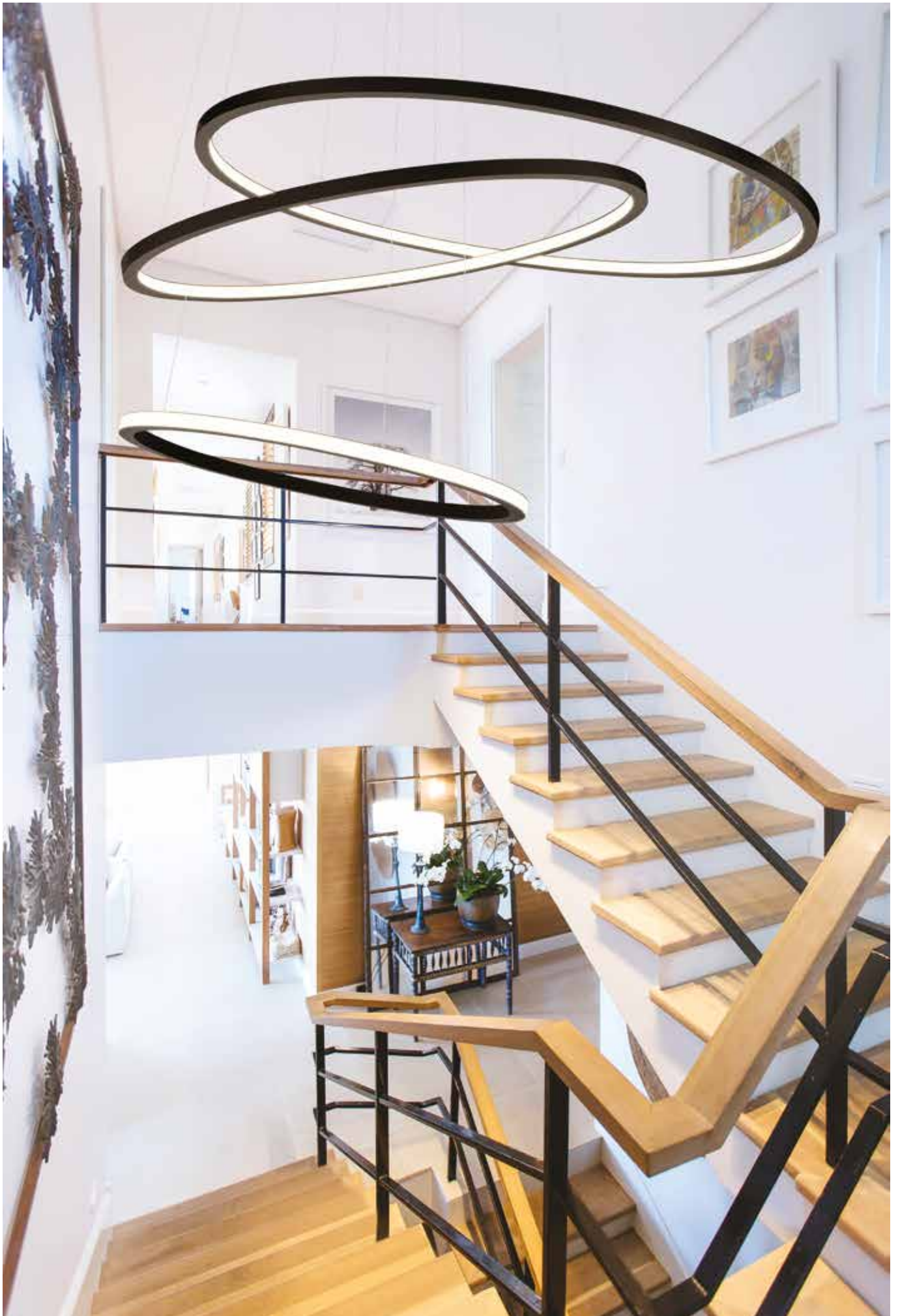

OREO /C



Características del productos

Cuerpo

Aluminio

**Acabado**

Pintado en epoxi-poliéster

**Sistema óptico**

bLINE - Difusor opalino

**Fuente de luz**

LED, RG1, CRI>90, MacAdam Step ≤3

Vida útil del LED

60.000h @ L80, B10, Ta 25°C

Fuente de alimentación

Driver LED 220-240V-50/60Hz incluido

01. Seleccionar versión



OREO /C



In/Out | bLINE - Difusor opalino

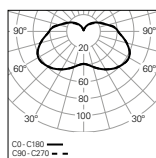

W
51

lm output
1697

lm/W
33

CÓDIGO*
90423L630▼▲●●00

Out | bLINE - Difusor opalino

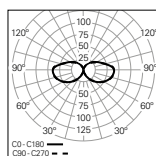

W
31

lm output
1100

lm/W
35

CÓDIGO*
90422L630▼▲●●00

*Sustituya los símbolos para completar el código

Fuente de alimentación ▼

HF	E
DALI	H
SwitchDIM ¹	O
OC	T

Color² ▲

□ Blanco	W
■ Gris	G
■ Negro	B
■ Sahara	0
■ Mist	1
■ Carbon	I
■ Autumn	L
■ Rusty chain	R
■ Jungle	N
■ Golden eye	D
■ Old rose	5
■ Copper	7

Temp. de color ●

2700K	2
3000K	3
4000K	0
Tunable White ³	T
RGB White ⁴	R



Detalles del producto



Difusor bLINE



Difusor clip-in

¹ Sólo disponible para versiones In/Out de 2700K, 3000K o 4000K.

² Ver página 212.

³ Tunable White (3000K - 5700K). Sólo disponible con fuente de alimentación OC OmniaControl.

⁴ RGB White (2700K). Sólo disponible con fuente de alimentación OC OmniaControl.

OREO In



Características del productos

Cuerpo

Aluminio

**Acabado**

Pintado en epoxi-poliéster

**Sistema óptico**

bLINE - Difusor opalino

Fuente de luz

LED, RG1, CRI>90, MacAdam Step ≤3

**Vida útil del LED**

60.000h @ L80, B10, Ta 25°C

Fuente de alimentación

No incluido

01. Seleccionar versión



OREO In

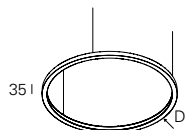

bLINE - Difusor opalino

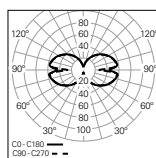

W	lm output	lm/W	Dmm	CÓDIGO*
26	1378	53	Ø650	90400L6500▲0◆00
38	2067	54	Ø970	90400L9700▲0◆00
50	2687	54	Ø1255	90400L1250▲0◆00
61	3307	54	Ø1540	90400L1540▲0◆00
78	4203	54	Ø1955	90400L1950▲0◆00

*Sustituya los símbolos para completar el código

Color ¹ ▲

□ Blanco	W
■ Gris	G
■ Negro	B
■ Sahara	0
■ Mist	1
■ Carbon	I
■ Autumn	L
■ Rusty chain	R
■ Jungle	N
■ Golden eye	D
■ Old rose	5
■ Copper	7

OREO In

- Cable de alimentación/suspensión de 1500 mm incluido.
- Para completar el producto es necesario pedir la base de alimentación por separado.
- Para las versiones RGB White, el producto incluye obligatoriamente un cable de alimentación transparente.

Temp. de color ◆

2700K	2
3000K	3
4000K	0
Tunable White ²	T
RGB White ³	R

¹ Ver página 212.

² Tunable White (3000K - 5700K). Sólo disponible con caja de alimentación Tunable White + OmniaControl.

³ RGB White (2700K). Sólo disponible con caja de alimentación RGB White + OmniaControl.

02. Seleccionar base de alimentación





Trimless

50 l  Ø120

 Ø128

HF



	CÓDIGO*
Ø650	975800 
Ø970, Ø1255	975801 
Ø1540, Ø1955	975803 

Empotrar

82 l  Ø150

 Ø128



HF

	CÓDIGO*
Ø650	975500 
Ø970, Ø1255	975501 
Ø1540, Ø1955	975503 

Superficie

41,5 l  Ø400



HF

	CÓDIGO*
Ø650	975200 
Ø970, Ø1255	975201 
Ø1540, Ø1955	975203 



*Sustituya los símbolos para completar el código

Color	
<input type="checkbox"/> Blanco	W
<input type="checkbox"/> Negro	B



DALI

	CÓDIGO*
Ø650	975900 
Ø970, Ø1255	975901 
Ø1540, Ø1955	975903 



DALI

	CÓDIGO*
Ø650	975600 
Ø970, Ø1255	975601 
Ø1540, Ø1955	975603 



DALI

	CÓDIGO*
Ø650	975300 
Ø970, Ø1255	975301 
Ø1540, Ø1955	975303 



OmniaControl

	CÓDIGO*
Ø650	976000 
Ø970, Ø1255	976001 
Ø1540, Ø1955	976003 





OmniaControl

	CÓDIGO*
Ø650	975700 
Ø970, Ø1255	975701 
Ø1540, Ø1955	975703 





OmniaControl

	CÓDIGO*
Ø650	975400 
Ø970, Ø1255	975401 
Ø1540, Ø1955	975403 





RGB White + OmniaControl

	CÓDIGO*
Ø650, Ø970	976005 
Ø1255	976007 
Ø1540	976008 
Ø1955	976009 





RGB White + OmniaControl

	CÓDIGO*
Ø650, Ø970	975705 
Ø1255	975707 
Ø1540	975708 
Ø1955	975709 





RGB White + OmniaControl

	CÓDIGO*
Ø650, Ø970	975405 
Ø1255	975407 
Ø1540	975408 
Ø1955	975409 





Tunable White + OmniaControl

	CÓDIGO*
Ø650, Ø970	976010 
Ø1255	976012 
Ø1540	976013 
Ø1955	976014 

Tunable White + OmniaControl

	CÓDIGO*
Ø650, Ø970	975710 
Ø1255	975712 
Ø1540	975713 
Ø1955	975714 

Tunable White + OmniaControl

	CÓDIGO*
Ø650, Ø970	975410 
Ø1255	975412 
Ø1540	975413 
Ø1955	975414 

BASE DE TECHO

- Driver incluido en la base de techo.
- Base de techo en versión sin marco (trimless) y empotrada es clase III.
- Base de superficie de clase I.

Detalles del producto



Difusor bLINE



Difusor clip-in



Base de techo de trimless



Base de techo de empotrar



Base de techo de superficie

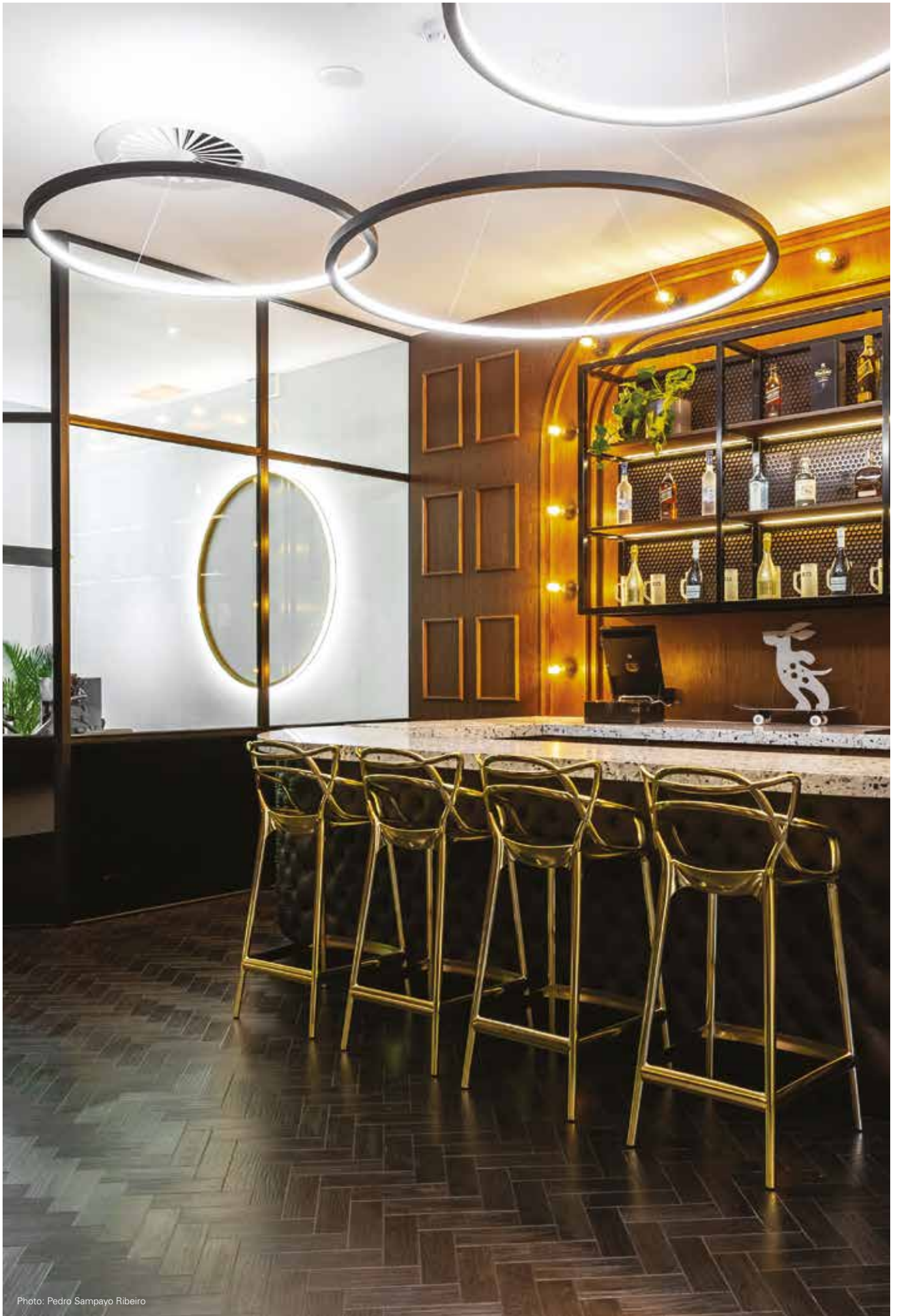

Photo: Pedro Sampayo Ribeiro

OREO Out



Características del productos

Cuerpo

Aluminio



Acabado

Pintado en epoxi-poliéster



Sistema óptico

bLINE - Difusor opalino

Fuente de luz

LED, RG1, CRI>90, MacAdam Step ≤3



Vida útil del LED

60.000h @ L80, B10, Ta 25°C

Fuente de alimentación

No incluido

01. Seleccionar versión



OREO Out

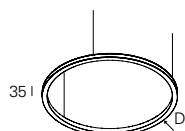

bLINE - Difusor opalino

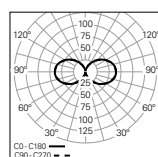

W	lm output	lm/W	Dmm	CÓDIGO*
23	1310	57	Ø630	90401L6300▲0◆00
36	2038	57	Ø950	90401L9500▲0◆00
49	2766	56	Ø1270	90401L1270▲0◆00
60	3422	57	Ø1555	90401L1550▲0◆00
77	4368	57	Ø1970	90401L1970▲0◆00

OREO Out

- Cable de alimentación/suspensión de 1500 mm incluido.
- Para completar el producto es necesario pedir la base de alimentación por separado.
- Para las versiones RGB White, el producto incluye obligatoriamente un cable de alimentación transparente.

*Sustituya los símbolos para completar el código

Color ¹	◆
□ Blanco	W
■ Gris	G
■ Negro	B
■ Sahara	0
■ Mist	1
■ Carbon	I
■ Autumn	L
■ Rusty chain	R
■ Jungle	N
■ Golden eye	D
■ Old rose	5
■ Copper	7

Temp. de color	◆
2700K	2
3000K	3
4000K	0
Tunable White ²	T
RGB White ³	R

¹ Ver página 212.

² Tunable White (3000K - 5700K). Sólo disponible con caja de alimentación Tunable White + OmniaControl.

³ RGB White (2700K). Sólo disponible con caja de alimentación RGB White + OmniaControl.

02. Seleccionar base de alimentación





Trimless

50 l  Ø120

 Ø128

HF



	CÓDIGO*
Ø630	975800 
Ø950, Ø1270	975801 
Ø1555, Ø1970	975803 

Empotrar

82 l  Ø150

 Ø128



HF

	CÓDIGO*
Ø630	975500 
Ø950, Ø1270	975501 
Ø1555, Ø1970	975503 

Superficie

41,5 l  Ø400



HF

	CÓDIGO*
Ø630	975200 
Ø950, Ø1270	975201 
Ø1555, Ø1970	975203 



*Sustituya los símbolos para completar el código

Color 
 Blanco W
 Negro B



DALI

	CÓDIGO*
Ø630	975900 
Ø950, Ø1270	975901 
Ø1555, Ø1970	975903 



DALI

	CÓDIGO*
Ø630	975600 
Ø950, Ø1270	975601 
Ø1555, Ø1970	975603 



DALI

	CÓDIGO*
Ø630	975300 
Ø950, Ø1270	975301 
Ø1555, Ø1970	975303 



OmniaControl

	CÓDIGO*
Ø630	976000 
Ø950, Ø1270	976001 
Ø1555, Ø1970	976003 





OmniaControl

	CÓDIGO*
Ø630	975700 
Ø950, Ø1270	975701 
Ø1555, Ø1970	975703 





OmniaControl

	CÓDIGO*
Ø630	975400 
Ø950, Ø1270	975401 
Ø1555, Ø1970	975403 





RGB White + OmniaControl

	CÓDIGO*
Ø630, Ø950	976005 
Ø1270	976007 
Ø1555	976008 
Ø1970	976009 





RGB White + OmniaControl

	CÓDIGO*
Ø630, Ø950	975705 
Ø1270	975707 
Ø1555	975708 
Ø1970	975709 





RGB White + OmniaControl

	CÓDIGO*
Ø630, Ø950	975405 
Ø1270	975407 
Ø1555	975408 
Ø1970	975409 





Tunable White + OmniaControl

	CÓDIGO*
Ø630, Ø950	976010 
Ø1270	976012 
Ø1555	976013 
Ø1970	976014 

Tunable White + OmniaControl

	CÓDIGO*
Ø630, Ø950	975710 
Ø1270	975712 
Ø1555	975713 
Ø1970	975714 

Tunable White + OmniaControl

	CÓDIGO*
Ø630, Ø950	975410 
Ø1270	975412 
Ø1555	975413 
Ø1970	975414 

BASE DE TECHO

- Driver incluido en la base de techo.
- Base de techo en versión sin marco (trimless) y empotrada es clase III.
- Base de superficie de clase I.

Detalles del producto



Difusor bLINE



Difusor clip-in



Base de techo de trimless



Base de techo de empotrar



Base de techo de superficie

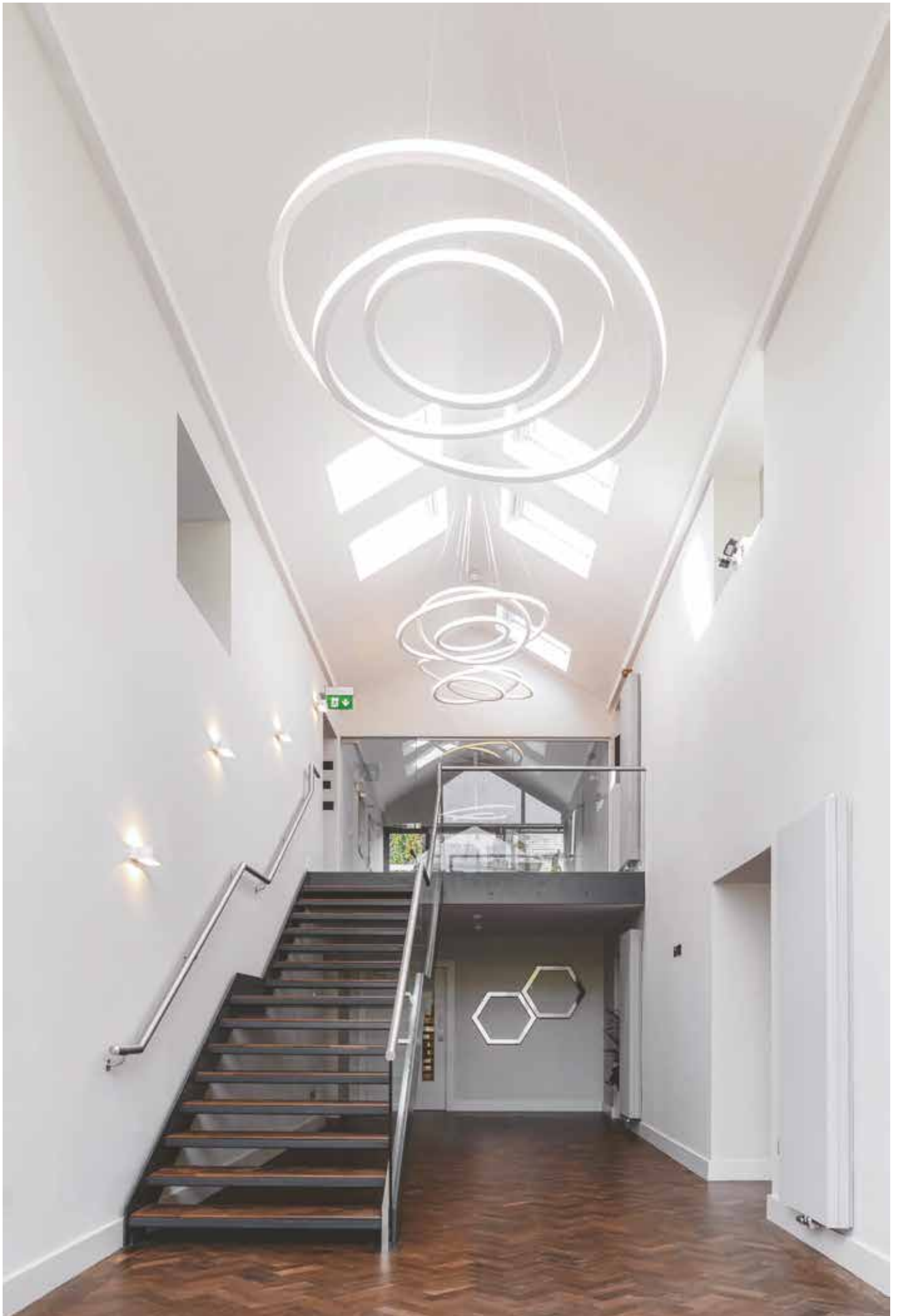

OREO V In



Características del productos

Cuerpo

Aluminio

Acabado

Pintado en epoxi-poliéster

Sistema óptico

bLINE - Difusor opalino

Fuente de luz

LED, RG1, CRI>90, MacAdam Step ≤3

Vida útil del LED

60.000h @ L80, B10, Ta 25°C

Fuente de alimentación

No incluido



01. Seleccionar versión

OREOV In

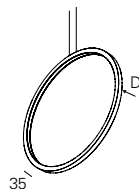

bLINE - Difusor opalino

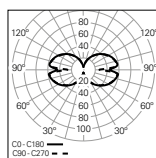

W	lm output	lm/W	Dmm	CÓDIGO*
26	1378	53	Ø650	90425L6500▲0◆00
38	2067	54	Ø970	90425L9700▲0◆00
50	2687	54	Ø1255	90425L1250▲0◆00
61	3307	54	Ø1540	90425L1540▲0◆00
78	4203	54	Ø1955	90425L1950▲0◆00

OREOV In

- Cable de alimentación/suspensión de 1500 mm incluido.
- Para completar el producto es necesario pedir la base de alimentación por separado.
- Para las versiones Ø1540 y Ø1955 mm el producto incluye obligatoriamente un cable de alimentación transparente.
- Para las versiones Tunable White y RGB White, el producto incluye obligatoriamente un cable de alimentación transparente.



*Sustituya los símbolos para completar el código

Color ¹	◆
□ Blanco	W
■ Gris	G
■ Negro	B
■ Sahara	0
■ Mist	1
■ Carbon	I
■ Autumn	L
■ Rusty chain	R
■ Jungle	N
■ Golden eye	D
■ Old rose	5
■ Copper	7

Temp. de color	◆
2700K	2
3000K	3
4000K	0
Tunable White ²	T
RGB White ³	R

¹ Ver página 212.

² Tunable White (3000K - 5700K). Sólo disponible con caja de alimentación Tunable White + OmniaControl.

³ RGB White (2700K). Sólo disponible con caja de alimentación RGB White + OmniaControl.

02. Seleccionar base de alimentación



Trimless

50 l Ø120

Ø128

HF

	CÓDIGO*
Ø650	976700
Ø970, Ø1255	976701
Ø1540, Ø1955	976703

DALI

	CÓDIGO*
Ø650	976800
Ø970, Ø1255	976801
Ø1540, Ø1955	976803

OmniaControl

	CÓDIGO*
Ø650	976900
Ø970, Ø1255	976901
Ø1540, Ø1955	976903

RGB White + OmniaControl

	CÓDIGO*
Ø650, Ø970	976905
Ø1255, Ø1540	976907
Ø1955	976909

Tunable White + OmniaControl

	CÓDIGO*
Ø650, Ø970	976910
Ø1255, Ø1540	976912
Ø1955	976914

Empotrar

82 l Ø150

Ø128

HF

	CÓDIGO*
Ø650	976400
Ø970, Ø1255	976401
Ø1540, Ø1955	976403

DALI

	CÓDIGO*
Ø650	976500
Ø970, Ø1255	976501
Ø1540, Ø1955	976503

OmniaControl

	CÓDIGO*
Ø650	976600
Ø970, Ø1255	976601
Ø1540, Ø1955	976603

RGB White + OmniaControl

	CÓDIGO*
Ø650, Ø970	976605
Ø1255, Ø1540	976607
Ø1955	976609

Tunable White + OmniaControl

	CÓDIGO*
Ø650, Ø970	976610
Ø1255, Ø1540	976612
Ø1955	976614

Superficie

a) 270
135
44

b) 320
145
44

HF

	CÓDIGO*
Ø650 ^{a)}	976100
Ø970, Ø1255 ^{a)}	976101
Ø1540, Ø1955 ^{b)}	976103

DALI

	CÓDIGO*
Ø650 ^{a)}	976200
Ø970, Ø1255 ^{a)}	976201
Ø1540, Ø1955 ^{b)}	976203

OmniaControl

	CÓDIGO*
Ø650 ^{a)}	976300
Ø970, Ø1255 ^{a)}	976301
Ø1540, Ø1955 ^{b)}	976303

RGB White + OmniaControl

	CÓDIGO*
Ø650, Ø970 ^{a)}	976305
Ø1255 ^{a)}	976307
Ø1540 ^{b)}	976308
Ø1955 ^{b)}	976309

Tunable White + OmniaControl

	CÓDIGO*
Ø650, Ø970 ^{a)}	976310
Ø1255 ^{a)}	976312
Ø1540 ^{b)}	976313
Ø1955 ^{b)}	976314

*Sustituya los símbolos para completar el código

Color Blanco W
 Negro B

BASE DE TECHO

- Driver incluido en la base de techo.
- Base de techo en versión sin marco (trimless) y empotrada es clase III.
- Base de superficie de clase I.

Detalles del producto



Difusor bLINE



Difusor clip-in



Base de techo de trimless



Base de techo de empotrar



Base de techo de superficie

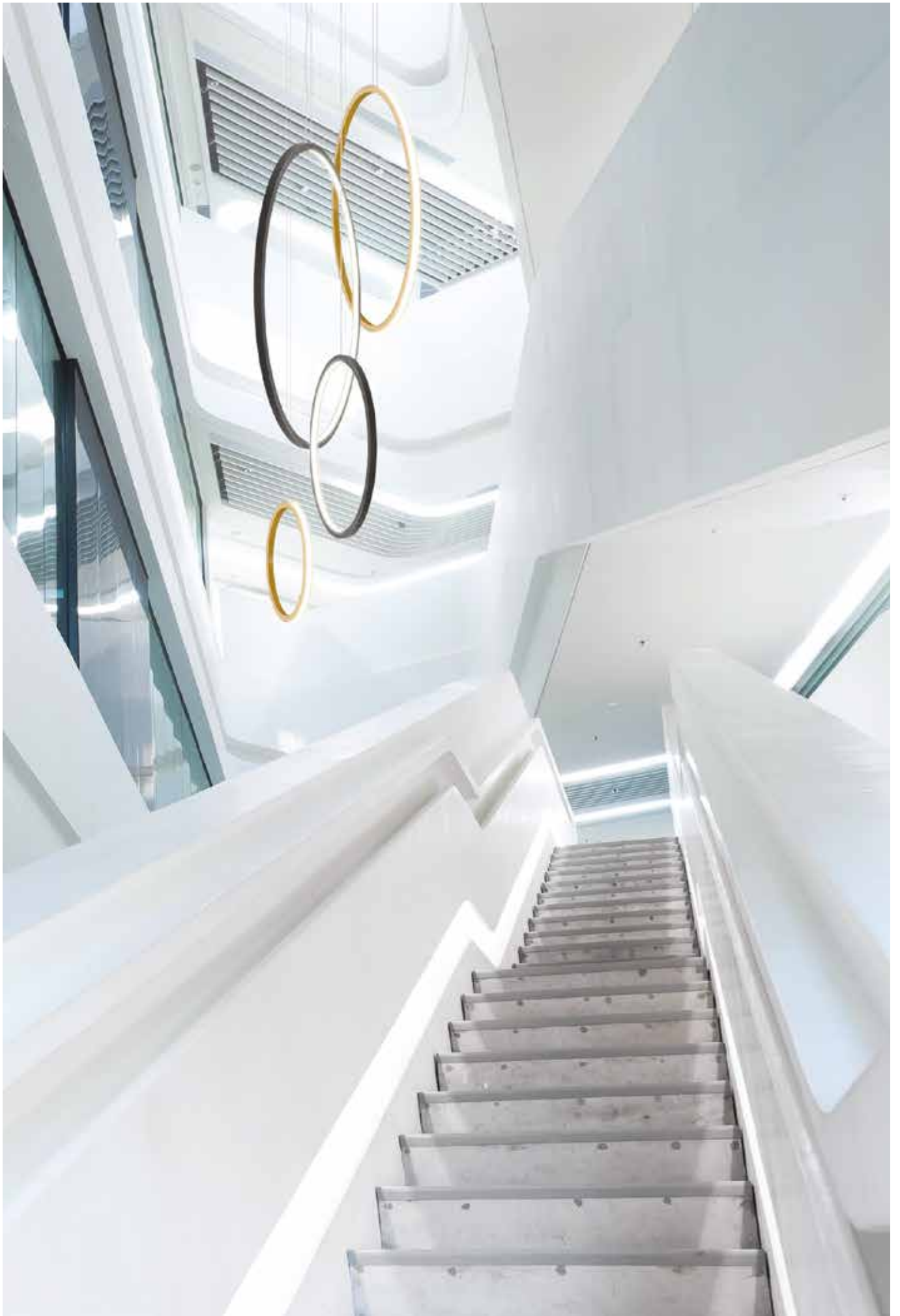

OREO V Out



Características del productos

Cuerpo

Aluminio

Acabado

Pintado en epoxi-poliéster

Sistema óptico

bLINE - Difusor opalino

Fuente de luz

LED, RG1, CRI>90, MacAdam Step ≤3

Vida útil del LED

60.000h @ L80, B10, Ta 25°C

Fuente de alimentación

No incluido



01. Seleccionar versión

OREOV Out

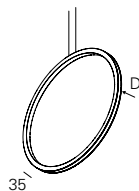

bLINE - Difusor opalino

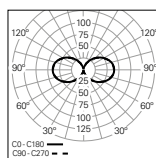

W	lm output	lm/W	Dmm	CÓDIGO*
22	1238	56	Ø630	90419L6300▲0◆00
35	1966	56	Ø950	90419L9500▲0◆00
47	2694	57	Ø1270	90419L1270▲0◆00
59	3349	57	Ø1555	90419L1550▲0◆00
76	4295	57	Ø1970	90419L1970▲0◆00

OREOV Out

- Cable de alimentación/suspensión de 1500 mm incluido.
- Para completar el producto es necesario pedir la base de alimentación por separado.
- Para las versiones Ø1555 y Ø1970 mm el producto incluye obligatoriamente un cable de alimentación transparente.
- Para las versiones Tunable White y RGB White, el producto incluye obligatoriamente un cable de alimentación transparente.



*Sustituya los símbolos para completar el código

Color ¹	◆
□ Blanco	W
■ Gris	G
■ Negro	B
■ Sahara	0
■ Mist	1
■ Carbon	I
■ Autumn	L
■ Rusty chain	R
■ Jungle	N
■ Golden eye	D
■ Old rose	5
■ Copper	7

Temp. de color	◆
2700K	2
3000K	3
4000K	0
Tunable White ²	T
RGB White ³	R

¹ Ver página 212.

² Tunable White (3000K - 5700K). Sólo disponible con caja de alimentación Tunable White + OmniaControl.

³ RGB White (2700K). Sólo disponible con caja de alimentación RGB White + OmniaControl.

02. Seleccionar base de alimentación



Trimless

50 | | Ø120

Ø128

HF

	CÓDIGO*
Ø630	976700
Ø950, Ø1270	976701
Ø1555, Ø1970	976703

DALI

	CÓDIGO*
Ø630	976800
Ø950, Ø1270	976801
Ø1555, Ø1970	976803

OmniaControl

	CÓDIGO*
Ø630	976900
Ø950, Ø1270	976901
Ø1555, Ø1970	976903

RGB White + OmniaControl

	CÓDIGO*
Ø630, Ø950	976905
Ø1270, Ø1555	976907
Ø1970	976909

Tunable White + OmniaControl

	CÓDIGO*
Ø630, Ø950	976910
Ø1270, Ø1555	976912
Ø1970	976914

Empotrar

82 | | Ø150

Ø128

HF

	CÓDIGO*
Ø630	976400
Ø950, Ø1270	976401
Ø1555, Ø1970	976403

DALI

	CÓDIGO*
Ø630	976500
Ø950, Ø1270	976501
Ø1555, Ø1970	976503

OmniaControl

	CÓDIGO*
Ø630	976600
Ø950, Ø1270	976601
Ø1555, Ø1970	976603

RGB White + OmniaControl

	CÓDIGO*
Ø630, Ø950	976605
Ø1270, Ø1555	976607
Ø1970	976609

Tunable White + OmniaControl

	CÓDIGO*
Ø630, Ø950	976610
Ø1270, Ø1555	976612
Ø1970	976614

Superficie

a) 270
135 | | 44

b) 320
145 | | 44

HF

	CÓDIGO*
Ø630 ^{a)}	976100
Ø950, Ø1270 ^{a)}	976101
Ø1555, Ø1970 ^{b)}	976103

DALI

	CÓDIGO*
Ø630 ^{a)}	976200
Ø950, Ø1270 ^{a)}	976201
Ø1555, Ø1970 ^{b)}	976203

OmniaControl

	CÓDIGO*
Ø630 ^{a)}	976300
Ø950, Ø1270 ^{a)}	976301
Ø1555, Ø1970 ^{b)}	976303

RGB White + OmniaControl

	CÓDIGO*
Ø630, Ø950 ^{a)}	976305
Ø1270 ^{a)}	976307
Ø1555 ^{b)}	976308
Ø1970 ^{b)}	976309

Tunable White + OmniaControl

	CÓDIGO*
Ø630, Ø950 ^{a)}	976310
Ø1270 ^{a)}	976312
Ø1555 ^{b)}	976313
Ø1970 ^{b)}	976314

*Sustituya los símbolos para completar el código

Color

Blanco W

Negro B

BASE DE TECHO

- Driver incluido en la base de techo.
- Base de techo en versión sin marco (trimless) y empotrada es clase III.
- Base de superficie de clase I.

Detalles del producto



Difusor bLINE



Difusor clip-in

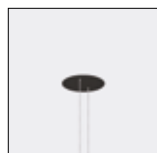

Base de techo de trimless



Base de techo de empotrar



Base de techo de superficie



OREO Linea Down



Características del productos

Cuerpo

Aluminio



Acabado

Pintado en epoxi-poliéster



Sistema óptico

bLINE - Difusor opalino



Fuente de luz

LED, RG1, CRI>90, MacAdam Step ≤3

Vida útil del LED

60.000h @ L80, B10, Ta 25°C

Fuente de alimentación

No incluido

01. Seleccionar versión

OREO Linea Down

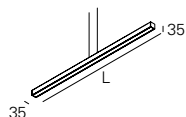

bLINE - Difusor opalino

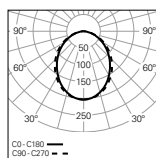

W	lm output	lm/W	Lmm	CÓDIGO*
13	637	49	1014	90420L1010▲0◆00
19	956	50	1514	90420L1510▲0◆00
26	1274	49	2014	90420L2010▲0◆00

OREO Linea Down

- Cable de alimentación/suspensión de 1500 mm incluido.
- Para completar el producto es necesario pedir la base de alimentación por separado.
- Para las versiones Tunable White y RGB White, el producto incluye obligatoriamente un cable de alimentación transparente.



*Sustituya los símbolos para completar el código

Color ¹ ▲

□ Blanco	W
■ Gris	G
■ Negro	B
■ Sahara	0
■ Mist	1
■ Carbon	I
■ Autumn	L
■ Rusty chain	R
■ Jungle	N
■ Golden eye	D
■ Old rose	5
■ Copper	7

Temp. de color ◆

2700K	2
3000K	3
4000K	0
Tunable White ²	T
RGB White ³	R

¹ Ver página 212.

² Tunable White (3000K - 5700K). Sólo disponible con caja de alimentación Tunable White + OmniaControl.

³ RGB White (2700K). Sólo disponible con caja de alimentación RGB White + OmniaControl.

02. Seleccionar base de alimentación

Trimless



122x62

HF

L1014, L1514, L2014
CÓDIGO* 977600

DALI

L1014, L1514, L2014
CÓDIGO* 977700

OmniaControl

L1014, L1514, L2014
CÓDIGO* 977800

RGB White + OmniaControl

L1014, L1514
L2014
CÓDIGO* 977805
CÓDIGO* 977806

Tunable White + OmniaControl

L1014, L1514
L2014
CÓDIGO* 977810
CÓDIGO* 977811

Empotrar



154x68

HF

L1014, L1514, L2014
CÓDIGO* 977300

DALI

L1014, L1514, L2014
CÓDIGO* 977400

OmniaControl

L1014, L1514, L2014
CÓDIGO* 977500

RGB White + OmniaControl

L1014, L1514
L2014
CÓDIGO* 977505
CÓDIGO* 977506

Tunable White + OmniaControl

L1014, L1514
L2014
CÓDIGO* 977510
CÓDIGO* 977511

Superficie



HF

L1014, L1514, L2014
CÓDIGO* 977900

DALI

L1014, L1514, L2014
CÓDIGO* 978000

OmniaControl

L1014, L1514, L2014
CÓDIGO* 978100

RGB White + OmniaControl

L1014, L1514
L2014
CÓDIGO* 978105
CÓDIGO* 978106

Tunable White + OmniaControl

L1014, L1514
L2014
CÓDIGO* 978110
CÓDIGO* 978111



*Sustituya los símbolos para completar el código

Color Blanco W
 Negro B

BASE DE TECHO

- Driver incluido en la base de techo.
- Base de techo en versión sin marco (trimless) y empotrada es clase III.
- Base de superficie de clase I.



Detalles del producto



Difusor bLINE

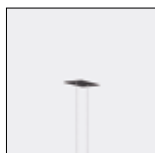

Base de techo de trimless



Base de techo de empotrar



Base de techo de superficie



OREO Linea Up



Características del producto

Cuerpo

Aluminio

Acabado

Pintado en epoxi-poliéster

Sistema óptico

bLINE - Difusor opalino

Fuente de luz

LED, RG1, CRI>90, MacAdam Step ≤ 3

Vida útil del LED

60.000h @ L80, B10, Ta 25°C

Fuente de alimentación

No incluido



01. Seleccionar versión

OREO Linea Up

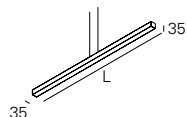

bLINE - Difusor opalino

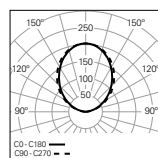

W	lm output	lm/W	Lmm	CÓDIGO*
12	573	48	1014	90399L1010♣0♦00
18	892	50	1514	90399L1510♣0♦00
24	1210	50	2014	90399L2010♣0♦00

OREO Linea Up

- Cabo de alimentação/suspensão com 1500 mm incluída.
- Para completar el producto es necesario pedir la base de alimentación por separado.
- Para las versiones Tunable White y RGB White, el producto incluye obligatoriamente un cable de alimentación transparente.



*Sustituya los símbolos para completar el código

Color ¹ ♣

□ Blanco	W
■ Gris	G
■ Negro	B
■ Sahara	0
■ Mist	1
■ Carbon	I
■ Autumn	L
■ Rusty chain	R
■ Jungle	N
■ Golden eye	D
■ Old rose	5
■ Copper	7

Temp. de color ♦

2700K	2
3000K	3
4000K	0
Tunable White ²	T
RGB White ³	R

¹ Ver página 212.

² Tunable White (3000K - 5700K). Sólo disponible con caja de alimentación Tunable White + OmniaControl.

³ RGB White (2700K). Sólo disponible con caja de alimentación RGB White + OmniaControl.

02. Seleccionar base de alimentación

Trimless



122x62

HF

L1014, L1514, L2014
CÓDIGO* 977600♣

DALI

L1014, L1514, L2014
CÓDIGO* 977700♣

OmniaControl

L1014, L1514, L2014
CÓDIGO* 977800♣

RGB White + OmniaControl

L1014, L1514
L2014
CÓDIGO* 977805♣
977806♣

Tunable White + OmniaControl

L1014, L1514
L2014
CÓDIGO* 977810♣
977811♣

Empotrar



154x68

HF

L1014, L1514, L2014
CÓDIGO* 977300♣

DALI

L1014, L1514, L2014
CÓDIGO* 977400♣

OmniaControl

L1014, L1514, L2014
CÓDIGO* 977500♣

RGB White + OmniaControl

L1014, L1514
L2014
CÓDIGO* 977505♣
977506♣

Tunable White + OmniaControl

L1014, L1514
L2014
CÓDIGO* 977510♣
977511♣

Superficie



HF

L1014, L1514, L2014
CÓDIGO* 977900♣

DALI

L1014, L1514, L2014
CÓDIGO* 978000♣

OmniaControl

L1014, L1514, L2014
CÓDIGO* 978100♣

RGB White + OmniaControl

L1014, L1514
L2014
CÓDIGO* 978105♣
978106♣

Tunable White + OmniaControl

L1014, L1514
L2014
CÓDIGO* 978110♣
978111♣



*Sustituya los
símbolos para
completar el código

Color ♣
□ Blanco W
■ Negro B

BASE DE TECHO

- Driver incluido en la base de techo.
- Base de techo en versión sin marco (trimless) y empotrada es clase III.
- Base de superficie de clase I.



Detalles del producto



Difusor bLINE

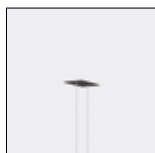

Base de techo de
trimless



Base de techo de
empotrar



Base de techo de
superficie

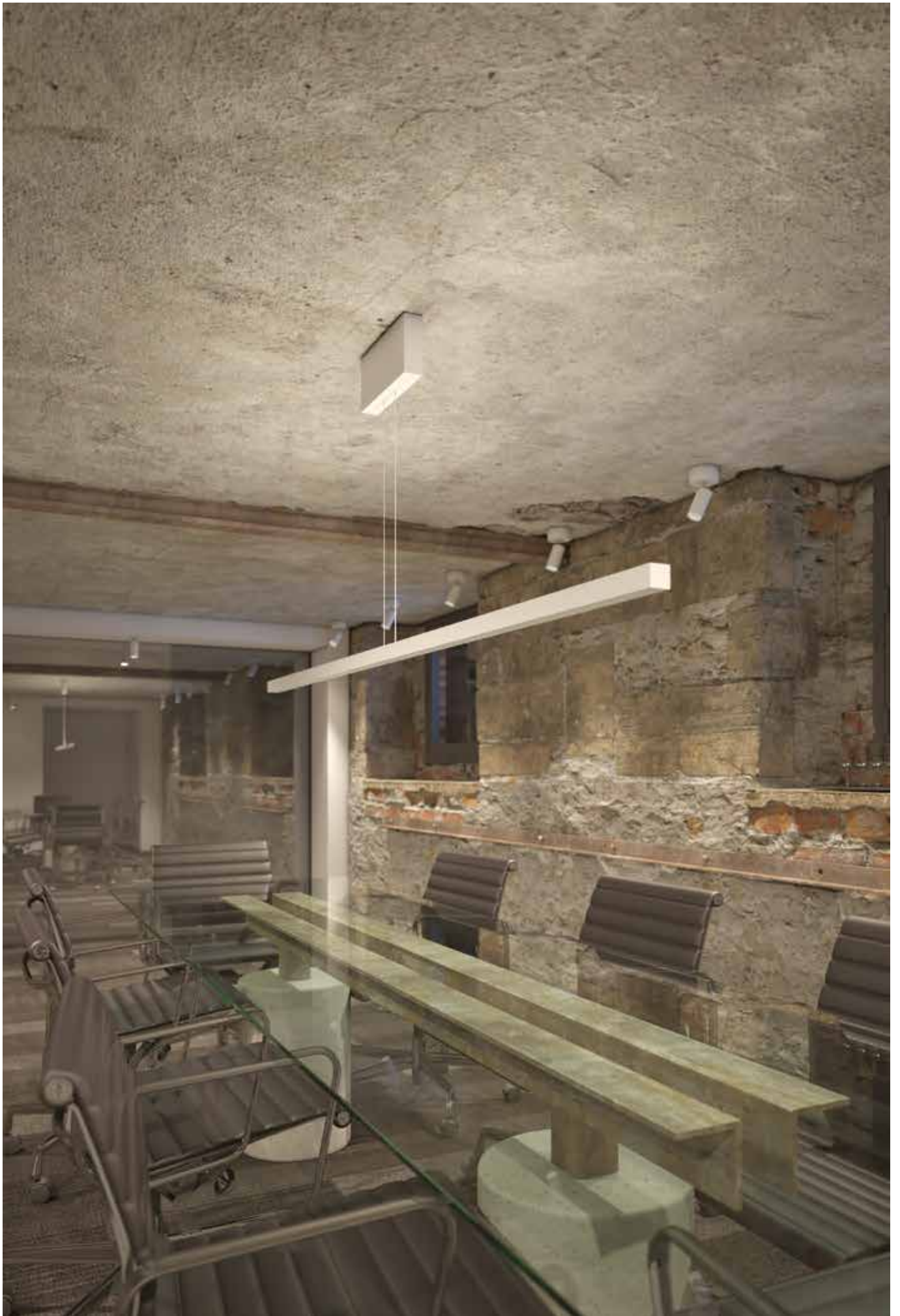



GLAM



GLAM
248



GLAM S4
254



GLAM S8
258



GLAM /W E
264



GLAM /W
268



GLAM 48V
274



Tipos de aplicación



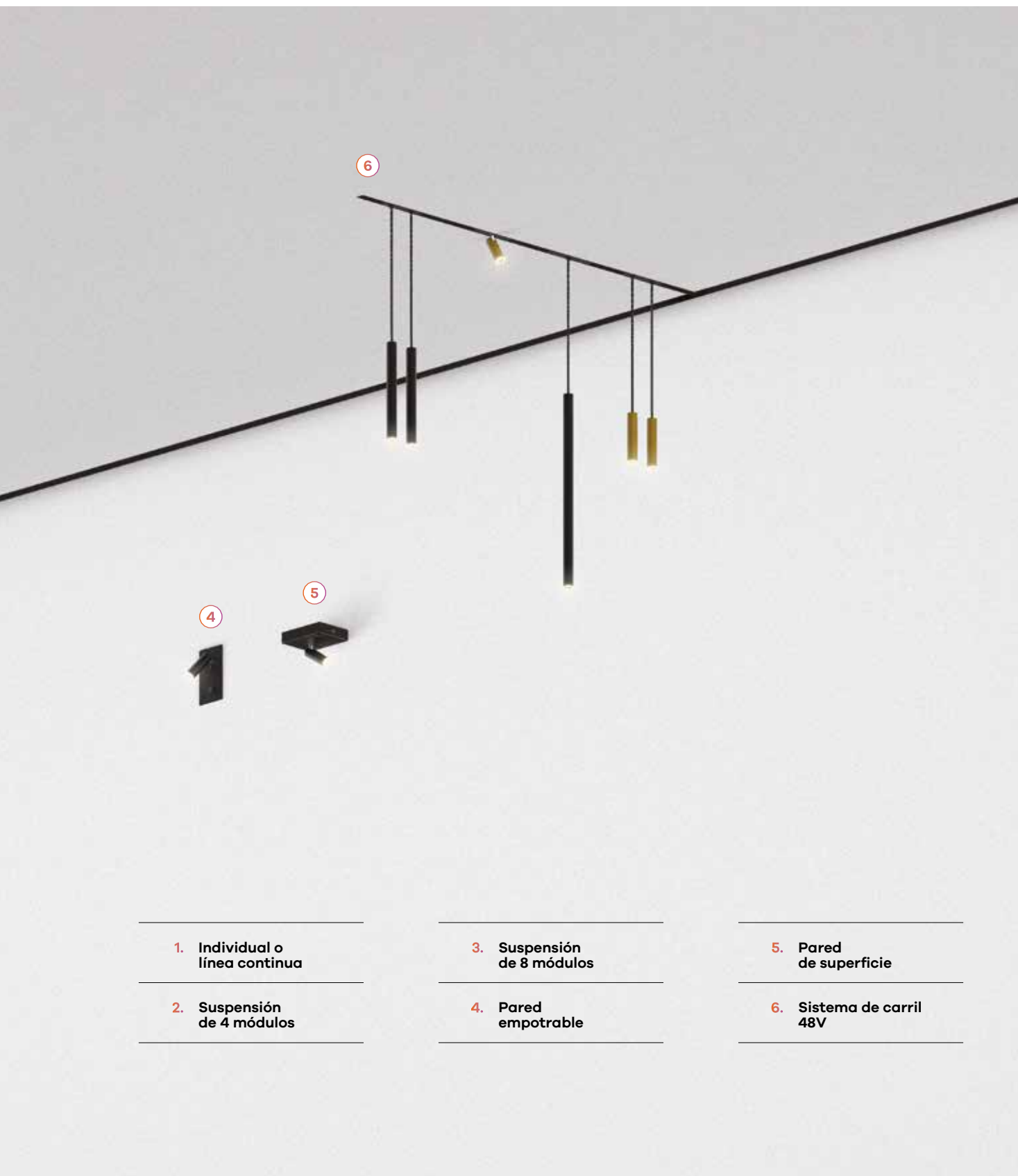

Minimalismo y tecnología



Escala 1:1

1. Cuerpo

Tubo de aluminio.
Disponible en versión suspendida con dimensiones de 150, 300, 450 o 600 mm, versión proyector con dimensiones de 80, 150 o 300 mm y versión empotrada con Ø59 mm.
12 colores disponibles.



2. LED

SDCM MacAdam ≤ 3 ,
temperatura de color 2700K / 4000K, CRI > 80 y vida útil de 75.000h L90 B10.

3. Fijación del LED

4. Sistema óptico

- 4.1 Lente de 14°
- 4.2 Lente de 47°
- 4.3 Lente oval

5. Marco decorativo

El marco decorativo con sistema clip-in fija la lente y proporciona un acabado minimalista y moderno.

6. Cable de alimentación y sistema de fijación

Cable de alimentación textil naranja, negro o marrón disponible en 1500 mm.
Sistema de fijación clip-in.



Sistema óptico

ILUMINACIÓN
ARQUITECTÓNICA



4.1. Lente de 14°

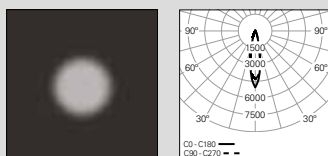
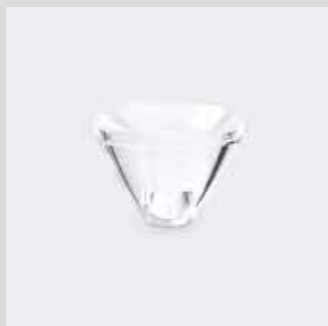

4.2. Lente de 47°

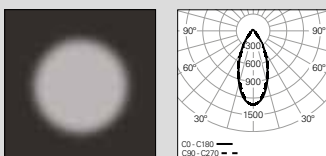
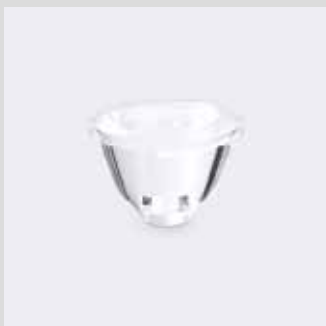

4.3. Lente oval

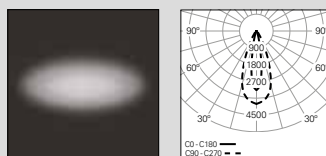
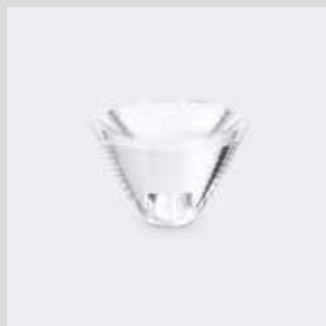

Defina su color

ILUMINACIÓN
ARQUITECTÓNICA

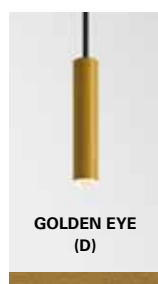



GLAM

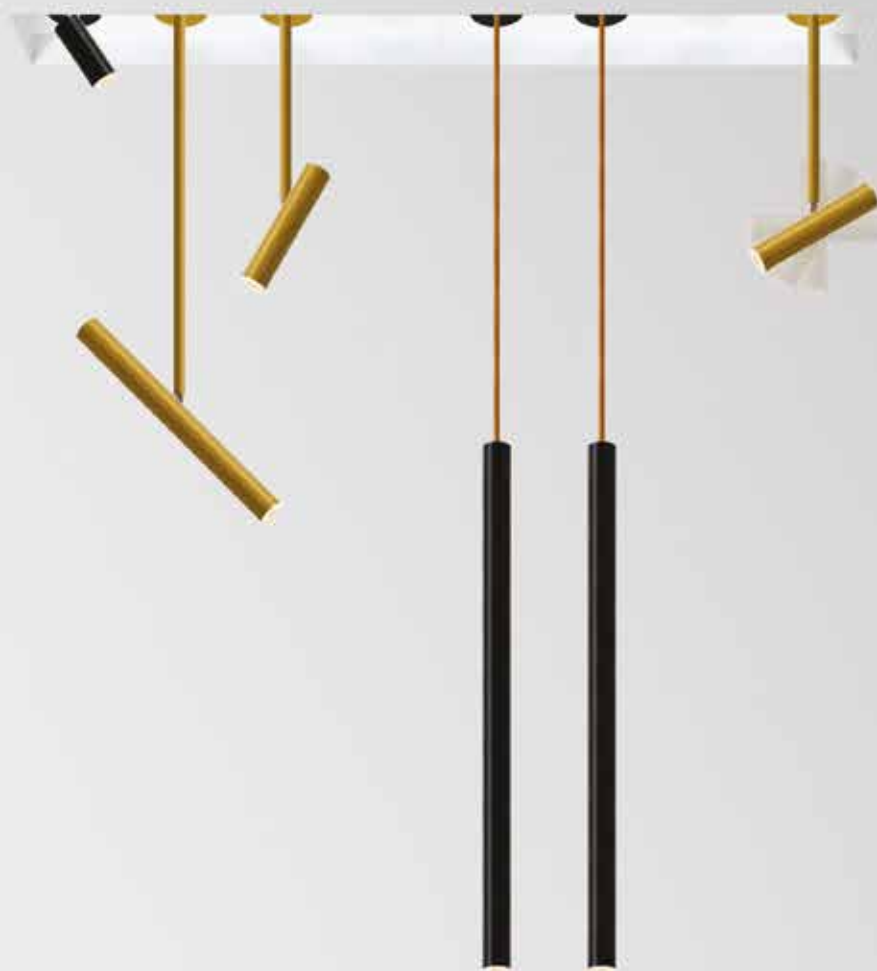

Características del productos

Cuerpo

Aluminio

Acabado

Pintado en epoxi-poliéster

Sistema óptico

Lente

Fuente de luz

LED, RG1, CRI>80, MacAdam Step ≤ 3

Vida útil del LED

75.000h @ L90, B10, Ta 25°C

Fuente de alimentación

No incluido



01. Seleccionar módulo



/S - Suspendido

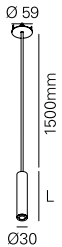

Lente (No incluida)

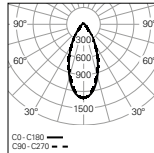

UGR	W	lm output	lm/W	mA	Lmm	CÓDIGO*
≤19	2	228	114	700	150	90063L150E▲0♦00
≤19	2	228	114	700	300	90063L300E▲0♦00
≤19	2	228	114	700	450	90063L450E▲0♦00
≤19	2	228	114	700	600	90063L600E▲0♦00

*Sustituya los símbolos para completar el código

Color ¹	
Blanco	W
Gris	G
Negro	B
Sahara	0
Mist	1
Carbon	I
Autumn	L
Rusty chain	R
Jungle	N
Golden eye	D
Old rose	5
Copper	7

/S - Suspendido

- Para completar el producto es necesario añadir sistema óptico, cable de alimentación y base de techo. Por favor solicítelo por separado.
- Los valores indicados corresponden a lentes de 47°.
- El módulo suspendido es clase III.

Temp. de color	
2700K	2
4000K	0

SPOT - Proyector



Lente (No incluida)

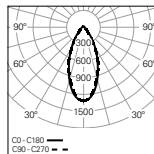

UGR	W	lm output	lm/W	mA	Lmm	Hmm	CÓDIGO*
≤19	2	228	114	700	80	12	90064L080E▲0♦00
≤19	2	228	114	700	150	197	90064L150E▲0♦00
≤19	2	228	114	700	300	371	90064L300E▲0♦00

SPOT - Proyector

- Para completar el producto es necesario añadir sistema óptico y base de techo. Por favor solicítelo por separado.
- Los valores indicados corresponden a lentes de 47°.
- El módulo SPOT - Proyector es clase III.

/E - Empotrar



Lente (No incluida)

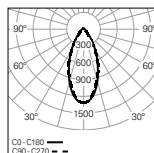

UGR	W	lm output	lm/W	mA	CÓDIGO*
≤19	2	228	114	700	90065L000E▲0♦00

/E - Empotrar

- Para completar el producto es necesario añadir sistema óptico y base de techo. Por favor solicítelo por separado.
- Los valores indicados corresponden a lentes de 47°.
- El módulo empotrado es clase III.

¹ Ver página 246.

02. Seleccionar base de alimentación



Trimless

Circular - Módulo LED 1

mA **CÓDIGO***
700 973301▲

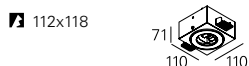

Empotrar

Circular - Módulo LED 1

mA **CÓDIGO***
700 973801▲



Superficie

Circular - Módulo LED 1

mA **CÓDIGO***
700 974301▲



*Sustituya los símbolos para completar el código

Color ▲
□ Blanco W
■ Negro B

Cuadrado - módulo LED 1

mA **CÓDIGO***
700 973401▲

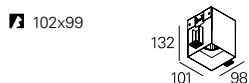

Cuadrado - módulo LED 1

mA **CÓDIGO***
700 973901▲



Cuadrado - módulo LED 1

mA **CÓDIGO***
700 974401▲



Rectangular - módulos LED 2

mA **CÓDIGO***
700 973402▲

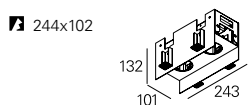

Rectangular - módulos LED 2

mA **CÓDIGO***
700 973902▲

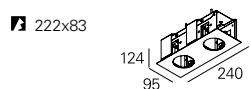

Rectangular - módulos LED 2

mA **CÓDIGO***
700 974402▲

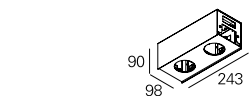

Rectangular - módulos LED 3

mA **CÓDIGO***
700 973403▲

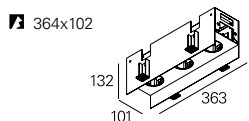

Rectangular - módulos LED 3

mA **CÓDIGO***
700 973903▲

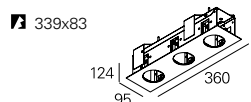

Rectangular - módulos LED 3

mA **CÓDIGO***
700 974403▲

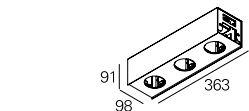

Rectangular - módulos LED 4

mA **CÓDIGO***
700 973404▲

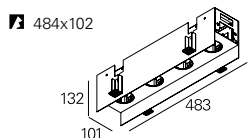

Rectangular - módulos LED 4

mA **CÓDIGO***
700 973904▲

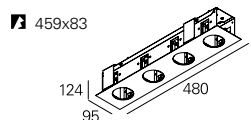

Rectangular - módulos LED 4



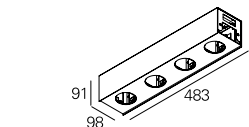

mA **CÓDIGO***
700 974404▲



BASE DE TECHO

- Driver HF incluido en la base de techo.
- Las bases de techo de 1 módulo LED son Individuales. Las bases de techo de 2, 3 y 4 módulos LED pueden ser Individuales o en línea continua.
- Las bases de techo de 2, 3 y 4 módulos LED no incluyen las tapas inicial/final. Para completar una línea es necesario un start kit. Por favor solicítelo por separado.
- La base de techo es clase I.

03. Seleccionar opciones

OPCIONES	Código*
Sistema óptico	
Lente de 14°	926200
Lente de 47°	926201
Lente oval	926202
Start kit - Tapas inicio/final	
Trimless	130  922300▲
Empotrar	73  922400▲
Superficie	90  922500▲
• Incluye dos tapas y tornillos.	
Cableado línea continua	
L240 mm - 3 x 1,5 mm ²	945620
L360 mm - 3 x 1,5 mm ²	945621
L480 mm - 3 x 1,5 mm ²	945622
Kit de unión	
Empotrar	931701
• Tornillos incluidos.	
Trimless / Superficie	931700
• Tornillos incluidos.	
Tapa ciega	
Blanco	Ø 59 992700
Negro	 992702
Cable de alimentación textil	
L1500 mm - Naranja	941700
L1500 mm - Negro	941800
L1500 mm - Marrón	941900



*Sustituya los símbolos para completar el código

Color ▲
 Blanco W
 Negro B



Detalles del producto



Lentes 14°, 47° u oval



Sistema de fijación de lentes



Efecto de luz con lente de 14°



Efecto de luz con lente de 47°



Efecto de luz con lente oval



Fijación y conexión rápida



Rotación de 355° y 90° de inclinación



Cable de alimentación textil (3 Colores)





GLAM S4



Características del productos

Cuerpo

Aluminio



Acabado

Pintado en epoxi-poliéster

230V/50Hz

Sistema óptico

Lente



Fuente de luz

LED, RG1, CRI>80, MacAdam Step ≤3



Vida útil del LED

75.000h @ L90, B10, Ta 25°C

Fuente de alimentación

Driver LED 220-240V-50/60Hz incluido

01. Seleccionar versión

GLAM S4 /E

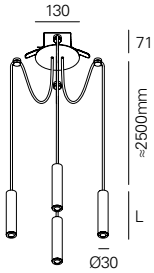

/E - Base de techo de empotrar | Lente (No incluida)

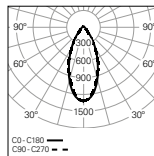

UGR	W	lm output	lm/W	Lmm	Ø	CÓDIGO*
≤19	11	912	83	150	Ø112	90098L150E♣0♦00
≤19	11	912	83	300	Ø112	90098L300E♣0♦00
≤19	11	912	83	450	Ø112	90098L450E♣0♦00
≤19	11	912	83	600	Ø112	90098L600E♣0♦00



*Sustituya los símbolos para completar el código

Color ¹	Symbol
Blanco	W
Gris	G
Negro	B
Sahara	0
Mist	1
Carbon	I
Autumn	L
Rusty chain	R
Jungle	N
Golden eye	D
Old rose	5
Copper	7

GLAM S4 /C

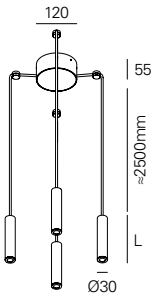

/C - Base de techo de superficie | Lente (No incluida)

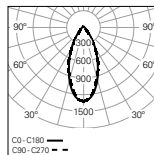

UGR	W	lm output	lm/W	Lmm	Ø	CÓDIGO*
≤19	11	912	83	150	Ø112	90093L150E♣0♦00
≤19	11	912	83	300	Ø112	90093L300E♣0♦00
≤19	11	912	83	450	Ø112	90093L450E♣0♦00
≤19	11	912	83	600	Ø112	90093L600E♣0♦00

Temp. de color	Symbol
2700K	2
4000K	0

GLAM S4 /E | GLAM S4 /C

- Incluye 4 clips transparentes.
- Para completar el producto es necesario añadir el sistema óptico y cable de alimentación textil deseado. Por favor solicítelo por separado.
- Los valores indicados corresponden a lentes de 47°.
- Base de techo en el color del producto. Otros colores bajo pedido.

¹ Ver página 246.

02. Seleccionar opciones

OPCIONES	Código
Sistema óptico	
Lente de 14°	926200
Lente de 47°	926201
Lente oval	926202
• Para completar el producto es necesario añadir 4 lentes.	
Sistema de fijación	
Clip transparente	926210
Cable de alimentación textil	
L2500 mm - Naranja	941701
L2500 mm - Negro	941801
L2500 mm - Marrón	941901
• Para completar el producto es necesario añadir 4 cables de alimentación.	



Detalles del producto



Lentes 14°, 47° u oval



Sistema de fijación de lentes



Efecto de luz con lente de 14°



Efecto de luz con lente de 47°



Efecto de luz con lente oval

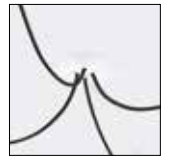

Base de techo de empotrar



Base de techo de superficie

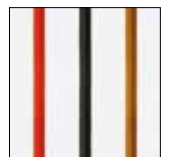

Cable de alimentación textil (3 Colores)



Clip transparente

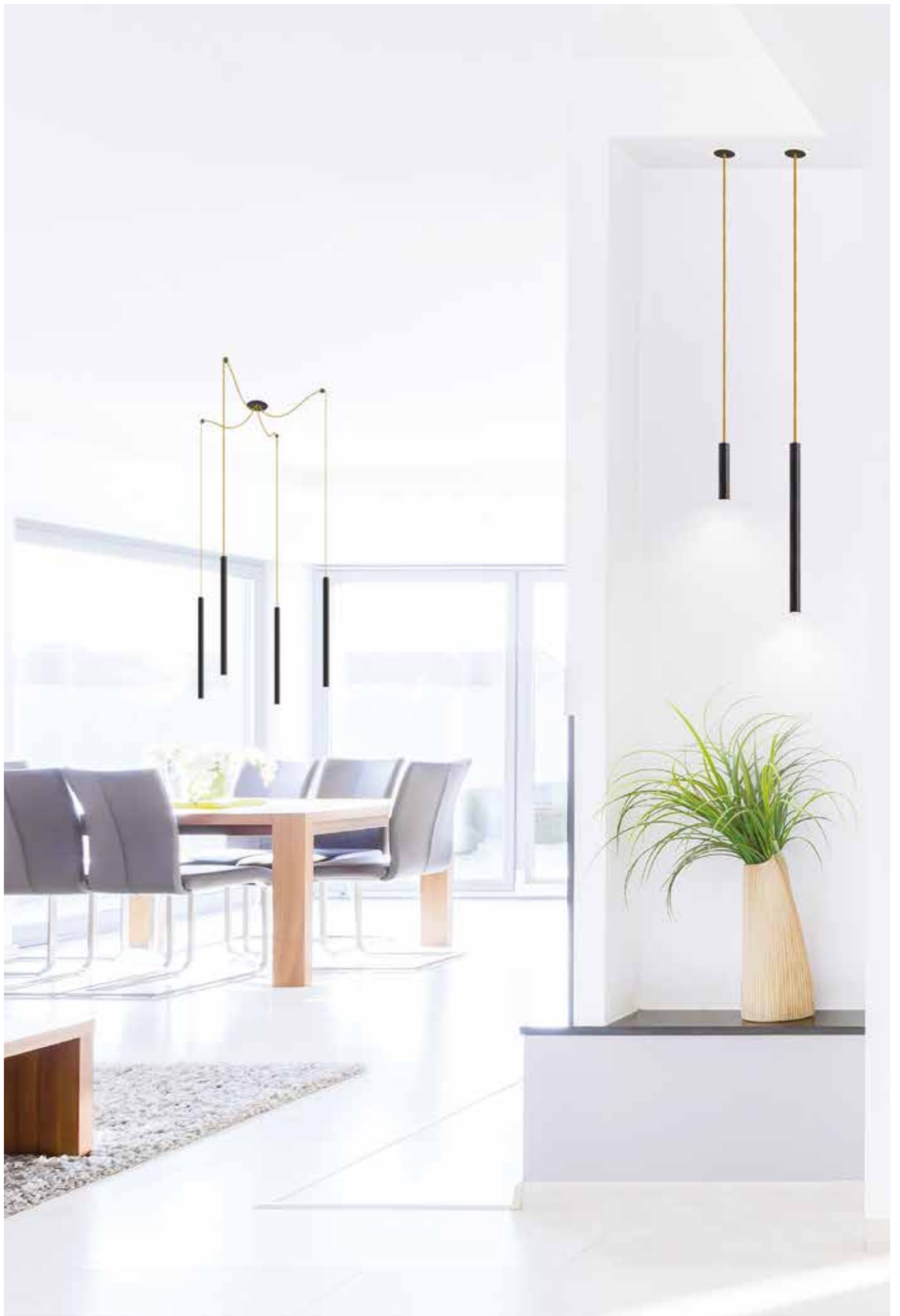

GLAM S8



Características del productos

Cuerpo

Aluminio



Acabado

Pintado en epoxi-poliéster

230V/50Hz

Sistema óptico

Lente



IP 20

Fuente de luz

LED, RG1, CRI>80, MacAdam Step ≤ 3

Vida útil del LED

75.000h @ L90, B10, Ta 25°C

650°C

Fuente de alimentación

Driver LED 220-240V-50/60Hz incluido

01. Seleccionar versión



GLAM S8 /E

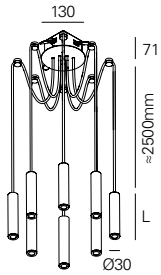

/E - Base de techo de empotrar | Lente (No incluida)

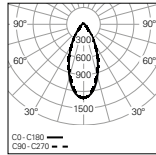

UGR	W	lm output	lm/W	Lmm	Ø	CÓDIGO*
≤19	20	1824	91	150	Ø112	90101L150E♣0♦00
≤19	20	1824	91	300	Ø112	90101L300E♣0♦00
≤19	20	1824	91	450	Ø112	90101L450E♣0♦00
≤19	20	1824	91	600	Ø112	90101L600E♣0♦00

*Sustituya los símbolos para completar el código

Color ¹	
Blanco	W
Gris	G
Negro	B
Sahara	0
Mist	1
Carbon	I
Autumn	L
Rusty chain	R
Jungle	N
Golden eye	D
Old rose	5
Copper	7

GLAM S8 /C

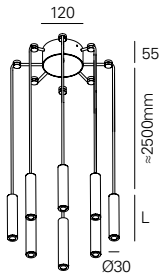

/C - Base de techo de superficie | Lente (No incluida)

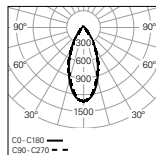

UGR	W	lm output	lm/W	Lmm	CÓDIGO*
≤19	20	1824	91	150	90099L150E♣0♦00
≤19	20	1824	91	300	90099L300E♣0♦00
≤19	20	1824	91	450	90099L450E♣0♦00
≤19	20	1824	91	600	90099L600E♣0♦00

Temp. de color	
2700K	2
4000K	0

GLAM S8 /E | GLAM S8 /C

- Incluye 8 clips transparentes.
- Para completar el producto es necesario añadir el sistema óptico y cable de alimentación textil deseado. Por favor solicítelo por separado.
- Los valores indicados corresponden a lentes de 47°.
- Base de techo en el color del producto. Otros colores bajo pedido.

¹ Ver página 246.

02. Seleccionar opciones

OPCIONES	Código
Sistema óptico	
Lente de 14°	926200
Lente de 47°	926201
Lente oval	926202
• Para completar el producto es necesario añadir 8 lentes.	
Sistema de fijación	
Clip transparente	926210
Cable de alimentación textil	
L2500 mm - Naranja	941701
L2500 mm - Negro	941801
L2500 mm - Marrón	941901
• Para completar el producto es necesario añadir 8 cables de alimentación.	



Detalles del producto



Lentes 14°, 47° u oval



Sistema de fijación de lentes



Efecto de luz con lente de 14°



Efecto de luz con lente de 47°



Efecto de luz con lente oval

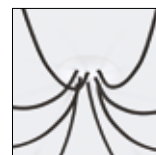

Base de techo de empotrar



Base de techo de superficie

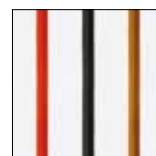

Cable de alimentación textil (3 Colores)



Clip transparente



Versiones de pared



1. Rotación de 355° y 90° de inclinación

El producto gira 355° y se inclina 90°, proporcionando versatilidad para iluminar objetos o áreas específicas.

2. Sensor ON/OFF

Está disponible una versión con sensor ON/OFF que ofrece mayor comodidad.

3. Puerto USB

Gracias al puerto USB podrás cargar tu dispositivo móvil.





GLAM /W E



Características del productos

Cuerpo

Aluminio

**Acabado**

Pintado en epoxi-poliéster

230V/50Hz

Sistema óptico

Lente

**Fuente de luz**

LED, RG1, CRI>80, MacAdam Step ≤3

Vida útil del LED

75.000h @ L90, B10, Ta 25°C

**Fuente de alimentación**

Driver LED 220-240V-50/60Hz incluido

01. Seleccionar versión

GLAM /W E

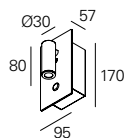

Lente (No incluida)

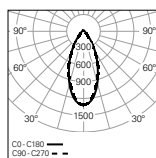

UGR
≤19

W
5

lm
output
228

74x122

CÓDIGO*
90089L003E♣♣♣

GLAM /W E

- Para completar el producto es necesario añadir el sistema óptico deseado. Por favor solicítelo por separado.
- Los valores indicados corresponden a lentes de 47°.



*Sustituya los símbolos para completar el código

Color ¹	♣
Blanco	W
Gris	G
Negro	B
Sahara	0
Mist	1
Carbon	I
Autumn	L
Rusty chain	R
Jungle	N
Golden eye	D
Old rose	5
Copper	7

Temp. de color	♦
2700K	2
4000K	0

Pulsador ON/OFF	♣
Estándar ²	00
Sensor ³	56

¹ Ver página 246.

² Versión con pulsador ON/OFF estándar.

³ Versión con sensor de movimiento ON/OFF.

02. Seleccionar opciones

OPCIONES	Código
Sistema óptico	
Lente de 14°	926200
Lente de 47°	926201
Lente oval	926202



Detalles del producto



Lentes 14°, 47° u oval



Sistema de fijación de lentes



Efecto de luz con lente de 14°



Efecto de luz con lente de 47°



Efecto de luz con lente oval



Pulsador ON/OFF estándar



Sensor ON/OFF



GLAM /W



Características del productos

Cuerpo

Aluminio

**Acabado**

Pintado en epoxi-poliéster

230V/50Hz

Sistema óptico

Lente



IP 20

Fuente de luz

LED, RG1, CRI>80, MacAdam Step ≤3

Vida útil del LED

75.000h @ L90, B10, Ta 25°C

650°C

Fuente de alimentación

Driver LED 220-240V-50/60Hz incluido

01. Seleccionar versión

LEFT - Proyector a la izquierda

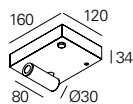

Lente (No incluida)

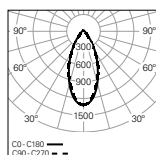

UGR
≤19

W
5

lm
output
228

CÓDIGO*
90078L003E♣♣♣



*Sustituya los símbolos para completar el código

Color ¹	♣
Blanco	W
Gris	G
Negro	B
Sahara	0
Mist	1
Carbon	I
Autumn	L
Rusty chain	R
Jungle	N
Golden eye	D
Old rose	5
Copper	7

RIGHT - Proyector a la derecha

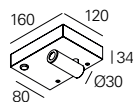

Lente (No incluida)

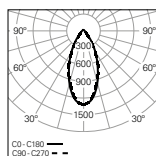

UGR
≤19

W
5

lm
output
228

CÓDIGO*
90070L003E♣♣♣

Temp. de color	♣
2700K	2
4000K	0

Pulsador ON/OFF	♣
Estándar ²	00
USB ³	55
Sensor ⁴	56
Sensor + USB ⁵	57

LEFT | RIGHT

- Para completar el producto es necesario añadir el sistema óptico deseado. Por favor solicítelo por separado.
- Los valores indicados corresponden a lentes de 47°.

¹ Ver página 246.

² Versión con pulsador ON/OFF estándar.

³ Versión con puerto USB.

⁴ Versión con sensor de movimiento ON/OFF.

⁵ Versión con sensor de movimiento ON/OFF y puerto USB.

02. Seleccionar opciones

OPCIONES	Código
Sistema óptico	
Lente de 14°	926200
Lente de 47°	926201
Lente oval	926202



Detalles del producto



Lentes 14°, 47° u oval



Sistema de fijación de lentes



Efecto de luz con lente de 14°



Efecto de luz con lente de 47°



Efecto de luz con lente oval



Pulsador ON/OFF estándar



Puerto USB



Sensor ON/OFF



Versión sistema de carril

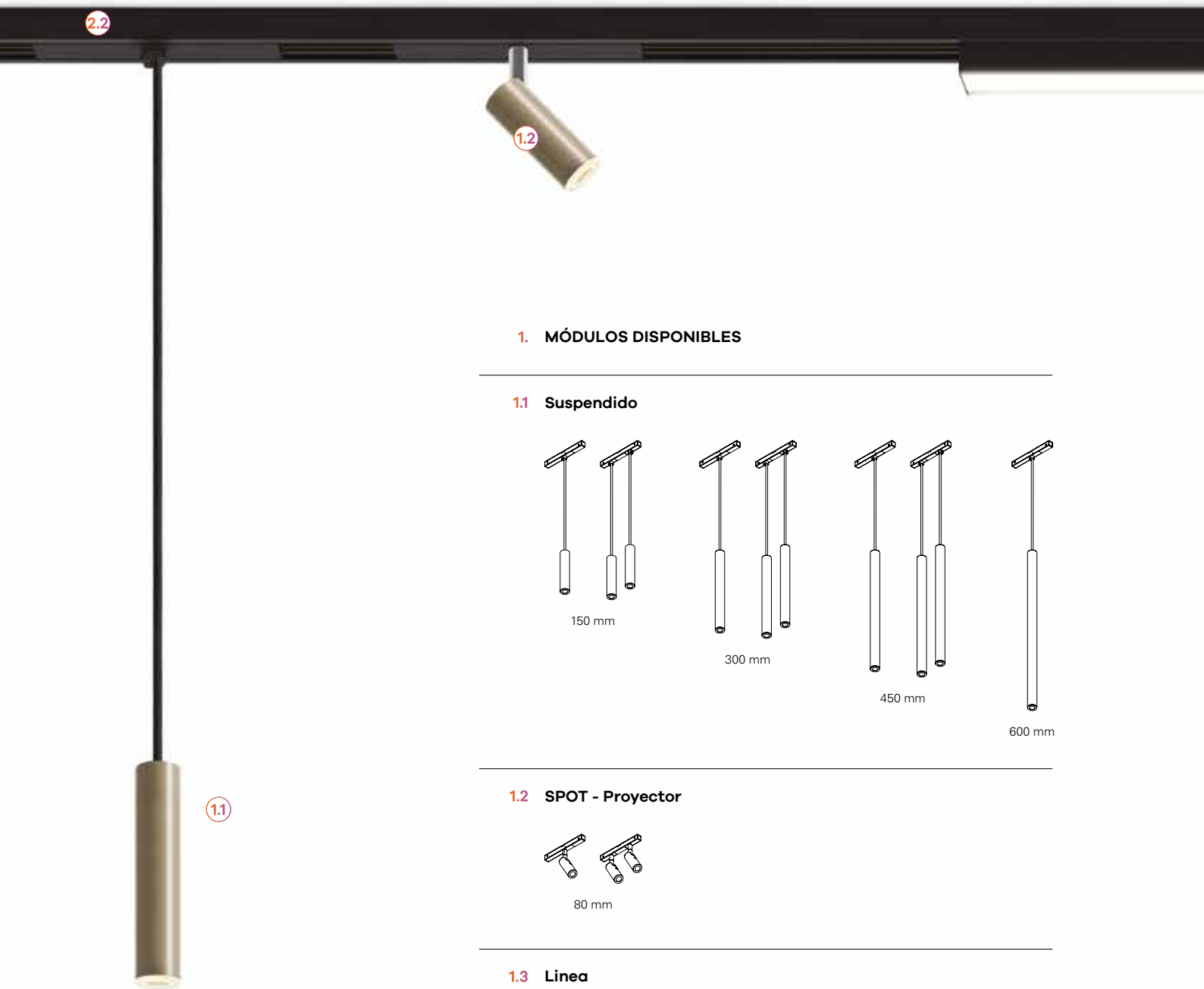

1. MÓDULOS DISPONIBLES

1.1 Suspendido

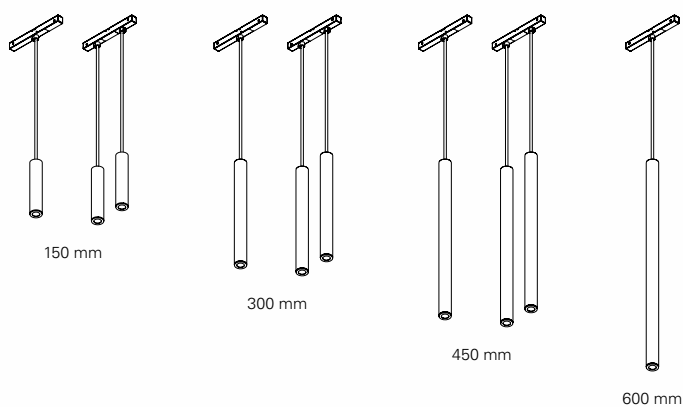

1.2 SPOT - Proyector

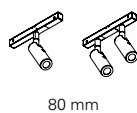

1.3 Línea

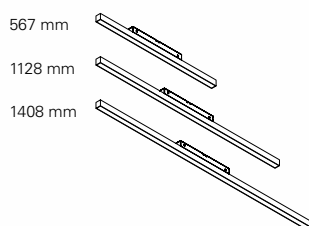

1.3

2. SISTEMA DE CARRIL



2.1 Empotrar



37x33 mm

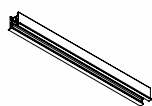

2.2 Superficie o suspendida



26x21 mm

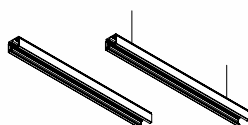

1.1

GLAM 48V



Características del productos

Cuerpo

Aluminio



Acabado

Pintado en epoxi-poliéster negro

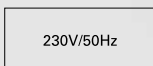

Sistema óptico

/S e Spot: Lente

Línea: bOPTICS - Reflector simétrico

Línea: bLINE - Difusor opalino

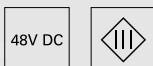

Fuente de luz

/S e Spot: LED, RG1, CRI>80,

MacAdam Step ≤3

Línea: LED, RG1, CRI>90, MacAdam Step ≤3



Vida útil del LED

/S e Spot: 75.000h @ L90, B10, Ta 25°C

Línea: 50.000h @ L90, B10, Ta 25°C

Fuente de alimentación

No incluida

01. Seleccionar sistema de carril

TRACK SYSTEM - SISTEMA DE CARRIL 48V

Empotrar

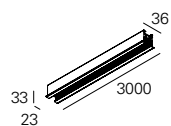

3000x27

CÓDIGO*
927801

Superficie o Suspendida

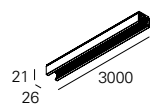

CÓDIGO*
927800

TRACK SYSTEM - SISTEMA DE CARRIL

- Para completar el producto es necesario añadir driver LED. Por favor solicítelo por separado.
- Perfil anodizado en negro.
- La distancia máxima entre el transformador y el carril es de 10000 mm.

02. Seleccionar módulo

/S - Suspendido

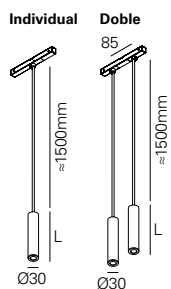

Lente (No incluida)

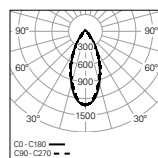

TIPO	UGR	W	lm output	lm/W	Lmm	CÓDIGO*
Individual	≤19	2	228	114	150	90835L150▼▲0◆00
Individual	≤19	2	228	114	300	90835L300▼▲0◆00
Individual	≤19	2	228	114	450	90835L450▼▲0◆00
Individual	≤19	2	228	114	600	90835L600▼▲0◆00
Doble	≤19	4	456	114	150	90835L15D▼▲0◆00
Doble	≤19	4	456	114	300	90835L30D▼▲0◆00
Doble	≤19	4	456	114	450	90835L45D▼▲0◆00

/S - Suspendido

- Incluye cable de alimentación textil negro con 1500 mm.
- Para completar el producto es necesario añadir el sistema óptico deseado. Por favor solicítelo por separado.
- Los valores indicados corresponden a lentes de 47°.

SPOT - Proyector

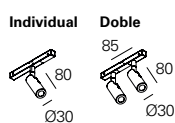

Lente (No incluida)

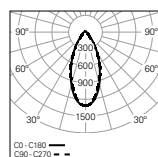

SPOT	UGR	W	lm output	lm/W	CÓDIGO*
Individual	≤19	2	228	114	90836L080▼▲0◆00
Doble	≤19	4	456	114	90836L08D▼▲0◆00

SPOT - Proyector

- Para completar el producto es necesario añadir el sistema óptico deseado. Por favor solicítelo por separado.
- Los valores indicados corresponden a lentes de 47°.

LINEA

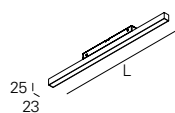

bOPTICS - Reflector simétrico

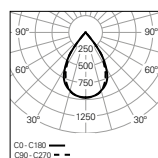

W	lm output	lm/W	Lmm	CÓDIGO*
11	867	79	567	90838L600▼00◆00
21	1734	83	1128	90838L120▼00◆00

bLINE - Difusor opalino

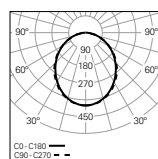

W	lm output	lm/W	Lmm	CÓDIGO*
11	1077	98	567	90837L600▼00◆00
23	2153	94	1128	90837L120▼00◆00
29	2692	93	1408	90837L150▼00◆00



*Sustituya los símbolos para completar el código

Fuente de alimentación ▼

HF E

DALI H

Color ¹ ▲

□ Blanco	W
■ Gris	G
■ Negro	B
■ Sahara	0
■ Mist	1
■ Carbon	I
■ Autumn	L
■ Rusty chain	R
■ Jungle	N
■ Golden eye	D
■ Old rose	5
■ Copper	7

Temp. de color ◆

2700K CRI>80 ²	2
4000K CRI>80 ²	0
2700K CRI>90	D
4000K CRI>90	A

03. Seleccionar opciones

OPCIONES	Código
Sistema óptico	
Lente de 14°	926200
Lente de 47°	926201
Lente oval	926202
• Para completar el producto en la versión doble es necesario pedir 2 lentes.	
Transformador 48V	
Potencia de 75W	965719
Potencia de 100W	965720
Potencia de 150W	965721
Tapa de alimentación	
HF / DALI	927850
Start kit - Tapas inicio/final	
Empotrable sin agujero (x1)	927810
Saliente sin agujero (x1)	927811
Saliente con agujero (x1)	927812
• Tornillos incluidos.	
Unión con alimentación	
HF / DALI	927860
Unión para perfil	
Empotrar	927820
• Unión de perfil en acero.	
Superficie	927821
• Unión de perfil de aluminio.	
Kit de fijación	
Empotrar	927830
• Kit de fijación en acero cincado.	
Kit de suspensión	
	927840
• 2 fixações e 2 suspensões incluídas.	
Proyectos a medida	
• Mediante solicitud.	



Detalles del producto



Lentes 14°, 47° u oval



Sistema de fijación de lentes



Efecto de luz con lente de 14°



Efecto de luz con lente de 47°



Efecto de luz con lente oval



Módulos con sistema de conexión rápida



Sistema de carril sin marco



Sistema de carril suspendido o de superficie



/S - Suspendido



SPOT - Proyector



LINEA - bOPTICS



LINEA - bLINE







ELI 50

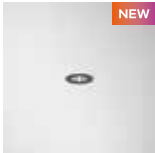

ELI 50 / E 1
284



ELI 50 / E 2
286



ELI 50 Sq / E 1
288



ELI 50 Sq / E 2
290

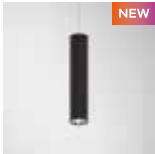

ELI 50
294

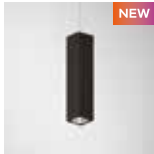

ELI 50 Sq
296



ELI 50 / C
300



ELI 50 Sq / C
302

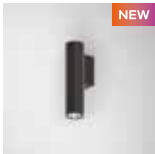

ELI 50 / W
304



ELI 50 Sq / W
306



ELI 50 / W D/I
308



ELI 50 Sq / W D/I
310

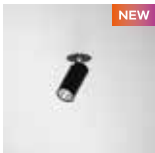

ELI 50 Spot / E 1
314



ELI 50 Spot / E 2
316



ELI 50 Spot / C
318



ELI 50 Spot Track
320



Tipos de aplicación



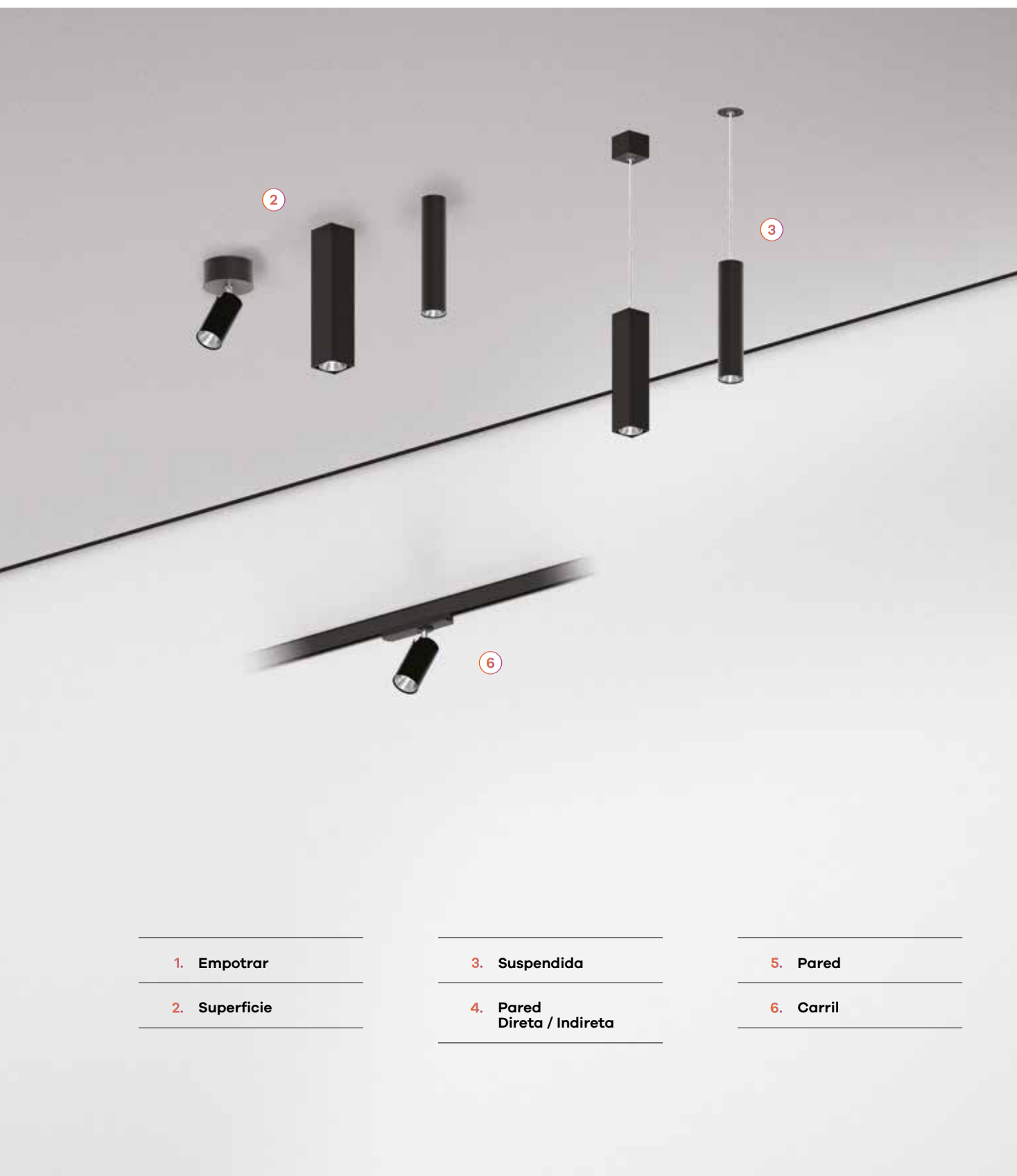

1. Empotrar

2. Superficie

3. Suspendida

**4. Pared
Directa / Indirecta**

5. Pared

6. Carril

ELI 50 /E 1



Características del productos

Cuerpo

Aluminio

**Acabado**

Pintado en epoxi-poliéster

**Sistema óptico**

PB - Reflector brillante

**Fuente de luz**

LED, RG1, CRI>90, MacAdam Step ≤3

Vida útil del LED

60.000h @ L80, B10, Ta 25°C

Fuente de alimentación

No incluida

Espesor del techo

Para techos entre 1-25 mm

01. Seleccionar versión

ELI 50 / E 1



PB - Reflector brillante - 20°

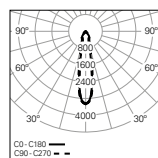

W	lm output	lm/W	mA	Ø	CÓDIGO*
5	747	149	150	Ø65	90695L0010▲0♦20
9	1168	130	250	Ø65	90694L0010▲0♦20

PB - Reflector brillante - 50°

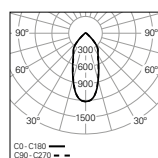

W	lm output	lm/W	mA	Ø	CÓDIGO*
5	724	145	150	Ø65	90695L0010▲0♦50
9	1144	127	250	Ø65	90694L0010▲0♦50



*Sustituya los símbolos para completar el código

Color ▲
 Blanco W
 Negro B

Temp. de Color ♦
 3000K 3
 4000K 0

ELI 50 / E 1

• Para completar el producto es necesario añadir driver LED. Por favor solicítelo por separado.

02. Seleccionar opciones

OPCIONES	Código
----------	--------

Fuente de alimentación HF	
Driver 6,3W 10-42V 150mA HF	900000E
Driver 10,5W 10-42V 250mA HF	900002E

Fuente de alimentación DALI	
Driver 7,8W 09-52V 150mA DALI+ PUSH	900100H
Driver 13W 09-52V 250mA DALI+ PUSH	900102H

Cable de seguridad en acero	
L1500 mm	955010

ELI 50 /E 2



Características del productos

Cuerpo

Aluminio

**Acabado**

Pintado en epoxi-poliéster

**Sistema óptico**

PB - Reflector brillante

**Fuente de luz**

LED, RG1, CRI>90, MacAdam Step ≤3

Vida útil del LED

60.000h @ L80, B10, Ta 25°C

Fuente de alimentación

No incluida

Espesor del techo

Para techos entre 1-25 mm

01. Seleccionar versión

ELI 50 / E 2



PB - Reflector brillante - 20°

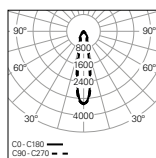

W	lm output	lm/W	mA	Ø	CÓDIGO*
10	1494	149	300	Ø60X120	90695L0020▲0◆20
17	2336	137	500	Ø60X120	90694L0020▲0◆20

CO - C180 —
C90 - C270 - -

PB - Reflector brillante - 50°

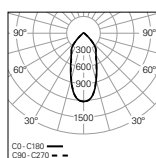

W	lm output	lm/W	mA	Ø	CÓDIGO*
10	1448	145	300	Ø60X120	90695L0020▲0◆50
17	2288	135	500	Ø60X120	90694L0020▲0◆50

CO - C180 —
C90 - C270 - -



*Sustituya los símbolos para completar el código

Color ▲
 Blanco W
 Negro B

Temp. de Color ◆
 3000K 3
 4000K 0

ELI 50 / E 2

• Para completar el producto es necesario añadir driver LED. Por favor solicítelo por separado.

02. Seleccionar opciones

OPCIONES Código

Fuente de alimentación HF

Driver 12,6W 10-42V 300mA HF	900003E
Driver 21W 10-42V 500mA HF	900007E

Fuente de alimentación DALI

Driver 15,6W 09-52V 300mA DALI+ PUSH	900103H
Driver 26W 09-52V 500mA DALI+ PUSH	900107H

Cable de seguridad en acero

L1500 mm	955010
----------	--------

ELI 50 Sq /E 1



Características del productos

Cuerpo

Aluminio

**Acabado**

Pintado en epoxi-poliéster

**Sistema óptico**

PB - Reflector brillante

**Fuente de luz**

LED, RG1, CRI>90, MacAdam Step ≤3

Vida útil del LED

60.000h @ L80, B10, Ta 25°C

Fuente de alimentación

No incluida

Espesor del techo

Para techos entre 1-25 mm

01. Seleccionar versión

ELI 50 Sq / E 1



PB - Reflector brillante - 20°

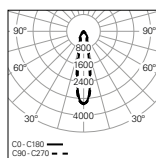

W	lm output	lm/W	mA	Ø	CÓDIGO*
5	747	149	150	Ø65	90697L0010▲0♦20
9	1168	130	250	Ø65	90696L0010▲0♦20

CO-C180 —
C90-C270 - -

PB - Reflector brillante - 50°

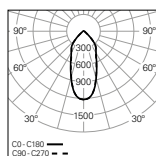

W	lm output	lm/W	mA	Ø	CÓDIGO*
5	724	145	150	Ø65	90697L0010▲0♦50
9	1144	127	250	Ø65	90696L0010▲0♦50

CO-C180 —
C90-C270 - -



*Sustituya los símbolos para completar el código

Color ▲
 Blanco W
 Negro B

Temp. de Color ♦
 3000K 3
 4000K 0

ELI 50 Sq / E 1

• Para completar el producto es necesario añadir driver LED. Por favor solicítelo por separado.

02. Seleccionar opciones

OPCIONES Código

Fuente de alimentación HF	
Driver 6,3W 10-42V 150mA HF	900000E
Driver 10,5W 10-42V 250mA HF	900002E

Fuente de alimentación DALI	
Driver 7,8W 09-52V 150mA DALI+ PUSH	900100H
Driver 13W 09-52V 250mA DALI+ PUSH	900102H

Cable de seguridad en acero	
L1500 mm	955010

ELI 50 Sq /E 2



Características del productos

Cuerpo

Aluminio

**Acabado**

Pintado en epoxi-poliéster

**Sistema óptico**

PB - Reflector brillante

**Fuente de luz**

LED, RG1, CRI>90, MacAdam Step ≤3

Vida útil del LED

60.000h @ L80, B10, Ta 25°C

Fuente de alimentación

No incluida

Espesor del techo

Para techos entre 1-25 mm

01. Seleccionar versión

ELI 50 Sq / E 2

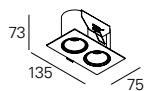

PB - Reflector brillante - 20°

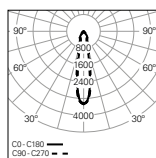

W	lm output	lm/W	mA	Ø	CÓDIGO*
10	1494	149	300	Ø60X120	90697L0020▲0♦20
17	2336	137	500	Ø60X120	90696L0020▲0♦20

PB - Reflector brillante - 50°

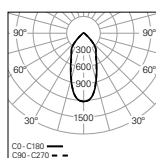

W	lm output	lm/W	mA	Ø	CÓDIGO*
10	1448	145	300	Ø60X120	90697L0020▲0♦50
17	2288	135	500	Ø60X120	90696L0020▲0♦50



*Sustituya los símbolos para completar el código

Color ▲
 Blanco W
 Negro B

Temp. de Color ♦
 3000K 3
 4000K 0

ELI 50 Sq / E 2

• Para completar el producto es necesario añadir driver LED. Por favor solicítelo por separado.

02. Seleccionar opciones

OPCIONES Código

Fuente de alimentación HF	
Driver 12,6W 10-42V 300mA HF	900003E
Driver 21W 10-42V 500mA HF	900007E

Fuente de alimentación DALI	
Driver 15,6W 09-52V 300mA DALI+ PUSH	900103H
Driver 26W 09-52V 500mA DALI+ PUSH	900107H

Cable de seguridad en acero	
L1500 mm	955010





ELI 50



Características del productos

Cuerpo

Aluminio

**Acabado**

Pintado en epoxi-poliéster

230V/50Hz

Sistema óptico

PB - Reflector brillante



IP 20

Fuente de luz

LED, RG1, CRI>90, MacAdam Step ≤3

Vida útil del LED

60.000h @ L80, B10, Ta 25°C

650°C

Fuente de alimentación

Driver LED 220-240V-50/60Hz incluido

01. Seleccionar versión

ELI 50

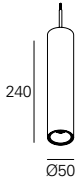

PB - Reflector brillante - 20°

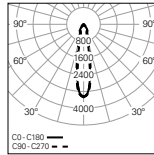

W
7
11

lm
output
747
1168

lm/W
107
106

CÓDIGO*

90679L240▼▲0◆20
90678L240▼▲0◆20

PB - Reflector brillante - 50°

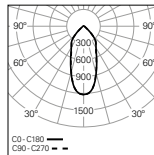

W
7
11

lm
output
724
1144

lm/W
103
104

CÓDIGO*

90679L240▼▲0◆50
90678L240▼▲0◆50



*Sustituya los símbolos para completar el código

Fuente de alimentación ▼
HF E
DALI H

Color ▲
□ Blanco W
■ Negro B

Temp. de Color ◆
3000K 3
4000K 0

ELI 50

• Para completar el producto es necesario pedir el cable y la base de alimentación por separado.

02. Seleccionar opciones



OPCIONES Código*

Cable de alimentación transparente

L1500 mm - 3 x 0,75 mm ²	940400
L1500 mm - 5 x 0,75 mm ²	940500
L3000 mm - 3 x 0,75 mm ²	940401
L3000 mm - 5 x 0,75 mm ²	940501
L6000 mm - 3 x 0,75 mm ²	940402
L6000 mm - 5 x 0,75 mm ²	940507

Base circular

Superficie T41 D50	45 Ø50	978805▲
Empotrar T42 D50	Ø40 32 Ø50	978804▲

*Sustituya los símbolos para completar el código

Color ▲
□ Blanco W
■ Negro B



Detalles del producto



Base de techo

ELI 50 Sq



Características del producto

Cuerpo

Aluminio

**Acabado**

Pintado en epoxi-poliéster

230V/50Hz

Sistema óptico

PB - Reflector brillante



IP 20

Fuente de luz

LED, RG1, CRI>90, MacAdam Step ≤3

Vida útil del LED

60.000h @ L80, B10, Ta 25°C

650°C

Fuente de alimentación

Driver LED 220-240V-50/60Hz incluido

01. Seleccionar versión

ELI 50 Sq

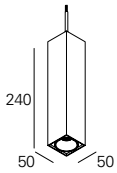

PB - Reflector brillante - 20°

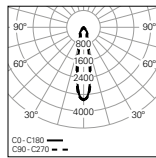

W	lm output	lm/W	CÓDIGO*
7	747	107	90687L240▼▲0◆20
11	1168	106	90686L240▼▲0◆20

PB - Reflector brillante - 50°

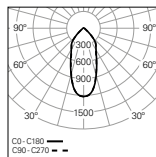

W	lm output	lm/W	CÓDIGO*
7	724	103	90687L240▼▲0◆50
11	1144	104	90686L240▼▲0◆50



*Sustituya los símbolos para completar el código

Fuente de alimentación ▼
 HF E
 DALI H

Color ▲
 □ Blanco W
 ■ Negro B

Temp. de Color ◆
 3000K 3
 4000K 0

ELI 50 Sq

• Para completar el producto es necesario pedir el cable y la base de alimentación por separado.

02. Seleccionar opciones



*Sustituya los símbolos para completar el código

OPCIONES Código*

Cable de alimentación transparente

L1500 mm - 3 x 0,75 mm ²	940400
L1500 mm - 5 x 0,75 mm ²	940500
L3000 mm - 3 x 0,75 mm ²	940401
L3000 mm - 5 x 0,75 mm ²	940501
L6000 mm - 3 x 0,75 mm ²	940402
L6000 mm - 5 x 0,75 mm ²	940507

Base cuadrada

Superficie T46 Q50	47 50	978807▲
Empotrar T47 Q50	Ø40 50	978808▲

Color ▲
 □ Blanco W
 ■ Negro B



Detalles del producto



Base de techo



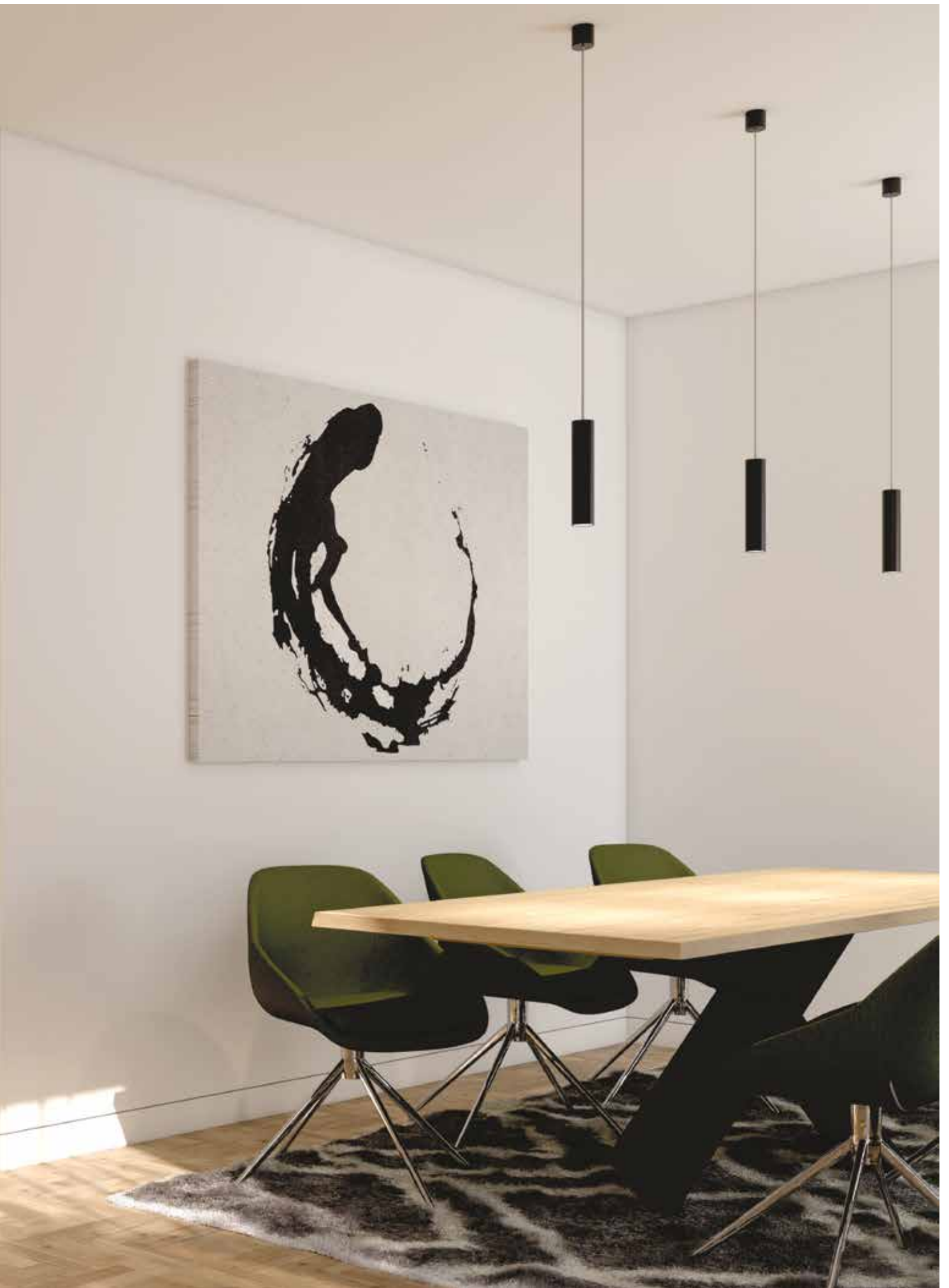

ELI 50 /C



Características del producto

Cuerpo

Aluminio

**Acabado**

Pintado en epoxi-poliéster

230V/50Hz

Sistema óptico

PB - Reflector brillante



IP 20

Fuente de luz

LED, RG1, CRI>90, MacAdam Step ≤3

Vida útil del LED

60.000h @ L80, B10, Ta 25°C

650°C

Fuente de alimentación

Driver LED 220-240V-50/60Hz incluido

01. Seleccionar versión



ELI 50 / C

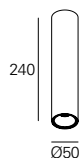

PB - Reflector brillante - 20°

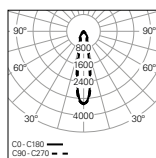

W	lm output	lm/W	CÓDIGO*
7	747	107	90681L240▼▲0◆20
11	1168	106	90680L240▼▲0◆20

PB - Reflector brillante - 50°

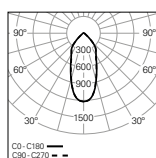

W	lm output	lm/W	CÓDIGO*
7	724	103	90681L240▼▲0◆50
11	1144	104	90680L240▼▲0◆50

*Sustituya los símbolos para completar el código

Fuente de alimentación ▼
 HF E
 DALI H

Color ▲
 □ Blanco W
 ■ Negro B

Temp. de Color ◆
 3000K 3
 4000K 0

ELI 50 Sq /C



Características del productos

Cuerpo

Aluminio

**Acabado**

Pintado en epoxi-poliéster

230V/50Hz

Sistema óptico

PB - Reflector brillante



IP 20

Fuente de luz

LED, RG1, CRI>90, MacAdam Step ≤3

Vida útil del LED

60.000h @ L80, B10, Ta 25°C

650°C

Fuente de alimentación

Driver LED 220-240V-50/60Hz incluido

01. Seleccionar versión



ELI 50 Sq /C

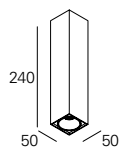

PB - Reflector brillante - 20°

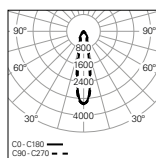

W
7
11

lm
output
747
1168

lm/W
107
106

CÓDIGO*

90689L240▼▲0◆20
90688L240▼▲0◆20

PB - Reflector brillante - 50°

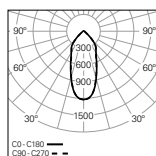

W
7
11

lm
output
724
1144

lm/W
103
104

CÓDIGO*

90689L240▼▲0◆50
90688L240▼▲0◆50

*Sustituya los símbolos para completar el código

Fuente de alimentación ▼
HF E
DALI H

Color ▲
□ Blanco W
■ Negro B

Temp. de Color ◆
3000K 3
4000K 0

ELI 50 /W



Características del productos

Cuerpo

Aluminio



Acabado

Pintado en epoxi-poliéster

230V/50Hz

Sistema óptico

PB - Reflector brillante



IP 20

Fuente de luz

LED, RG1, CRI>90, MacAdam Step ≤3

Vida útil del LED

60.000h @ L80, B10, Ta 25°C

650°C

Fuente de alimentación

Driver LED 220-240V-50/60Hz incluido

01. Seleccionar versión



ELI 50 /W

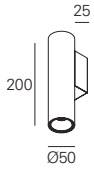

PB - Reflector brillante - 20°

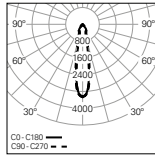

W	lm output	lm/W	CÓDIGO*
7	747	107	90683L200▼▲0♦20
11	1168	106	90682L200▼▲0♦20

PB - Reflector brillante - 50°

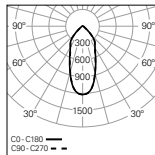

W	lm output	lm/W	CÓDIGO*
7	724	103	90683L200▼▲0♦50
11	1144	104	90682L200▼▲0♦50

*Sustituya los símbolos para completar el código

Fuente de alimentación ▼

HF	E
DALI	H

Color ▲

□ Blanco	W
■ Negro	B

Temp. de Color ♦

3000K	3
4000K	0

ELI 50 Sq /W



Características del producto

Cuerpo

Aluminio



Acabado

Pintado en epoxi-poliéster

230V/50Hz

Sistema óptico

PB - Reflector brillante



IP 20

Fuente de luz

LED, RG1, CRI>90, MacAdam Step ≤3

Vida útil del LED

60.000h @ L80, B10, Ta 25°C

650°C

Fuente de alimentación

Driver LED 220-240V-50/60Hz incluido

01. Seleccionar versión



ELI 50 Sq /W

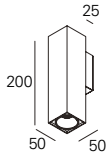

PB - Reflector brillante - 20°

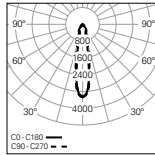

W	lm output	lm/W	CÓDIGO*
7	747	107	90691L200▼▲0◆20
11	1168	106	90690L200▼▲0◆20

CG-C180 —
CG-C270 - -

PB - Reflector brillante - 50°

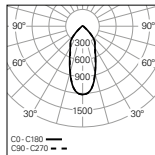

W	lm output	lm/W	CÓDIGO*
7	724	103	90691L200▼▲0◆50
11	1144	104	90690L200▼▲0◆50

CG-C180 —
CG-C270 - -

*Sustituya los símbolos para completar el código

Fuente de alimentación	▼
HF	E
DALI	H

Color	▲
□ Blanco	W
■ Negro	B

Temp. de Color	◆
3000K	3
4000K	0

ELI 50 /W D/I



Características del producto

Cuerpo

Aluminio

**Acabado**

Pintado en epoxi-poliéster

230V/50Hz

Sistema óptico

PB - Reflector brillante



IP 20

Fuente de luz

LED, RG1, CRI>90, MacAdam Step ≤3

Vida útil del LED

60.000h @ L80, B10, Ta 25°C

650°C

Fuente de alimentación

Driver LED 220-240V-50/60Hz incluido

01. Seleccionar versión



ELI 50 /W D/I

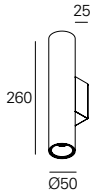

PB - Reflector brillante - 20°

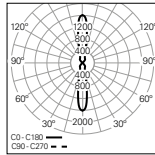

W
10

lm output
1254

lm/W
125

CÓDIGO*
90684L260▼▲0♦20

*Sustituya los símbolos para completar el código

Fuente de alimentación ▼
HF E
DALI H

Color ▲
□ Blanco W
■ Negro B

PB - Reflector brillante - 50°

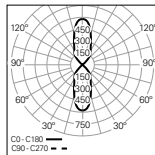

W
10

lm output
1214

lm/W
121

CÓDIGO*
90684L260▼▲0♦50

Temp. de Color ♦
3000K 3
4000K 0

ELI 50 Sq /W D/I



Características del productos

Cuerpo

Aluminio



Acabado

Pintado en epoxi-poliéster

230V/50Hz

Sistema óptico

PB - Reflector brillante



IP 20

Fuente de luz

LED, RG1, CRI>90, MacAdam Step ≤3

Vida útil del LED

60.000h @ L80, B10, Ta 25°C

650°C

Fuente de alimentación

Driver LED 220-240V-50/60Hz incluido

01. Seleccionar versión



ELI 50 Sq /W D/I

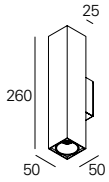

PB - Reflector brillante - 20°

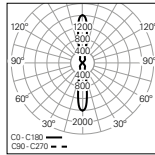

W
10

lm output
1254

lm/W
125

CÓDIGO*
90692L260▼▲0◆20

*Sustituya los símbolos para completar el código

Fuente de alimentación ▼
HF E
DALI H

Color ▲
□ Blanco W
■ Negro B

PB - Reflector brillante - 50°

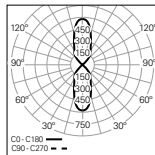

W
10

lm output
1214

lm/W
121

CÓDIGO*
90692L260▼▲0◆50

Temp. de Color ◆
3000K 3
4000K 0





ELI 50 Spot /E 1



Características del productos

Cuerpo

Aluminio

**Acabado**

Pintado en epoxi-poliéster

**Sistema óptico**

PB - Reflector brillante

**Fuente de luz**

LED, RG1, CRI>90, MacAdam Step ≤3

Vida útil del LED

60.000h @ L80, B10, Ta 25°C

**Fuente de alimentación**

No incluida

Espesor del techo

Para techos entre 1-25 mm

01. Seleccionar versión

ELI 50 Spot / E 1

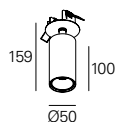

PB - Reflector brillante - 20°

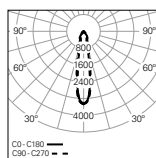

W	lm output	lm/W	mA	Ø	CÓDIGO*
5	747	149	150	Ø50	90703L0010♣0♦20
9	1168	130	250	Ø50	90702L0010♣0♦20

PB - Reflector brillante - 50°

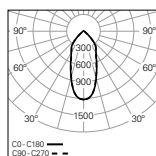

W	lm output	lm/W	mA	Ø	CÓDIGO*
5	724	145	150	Ø50	90703L0010♣0♦50
9	1144	127	250	Ø50	90702L0010♣0♦50



*Sustituya los símbolos para completar el código

Color
 Blanco W
 Negro B

Temp. de Color
 3000K 3
 4000K 0

ELI 50 Spot / E 1

• Para completar el producto es necesario añadir driver LED. Por favor solicítelo por separado.

02. Seleccionar opciones

OPCIONES Código

Fuente de alimentación HF	
Driver 6,3W 10-42V 150mA HF	900000E
Driver 10,5W 10-42V 250mA HF	900002E

Fuente de alimentación DALI	
Driver 7,8W 09-52V 150mA DALI+ PUSH	900100H
Driver 13W 09-52V 250mA DALI+ PUSH	900102H

Cable de seguridad en acero	
L1500 mm	955010



Detalles del producto



Rotación de 355° y 90° de inclinación

ELI 50 Spot /E 2



Características del productos

Cuerpo

Aluminio

**Acabado**

Pintado en epoxi-poliéster

**Sistema óptico**

PB - Reflector brillante

**Fuente de luz**

LED, RG1, CRI>90, MacAdam Step ≤3

Vida útil del LED

60.000h @ L80, B10, Ta 25°C

**Fuente de alimentación**

No incluida

Espesor del techo

Para techos entre 1-25 mm

01. Seleccionar versión

ELI 50 Spot / E 2

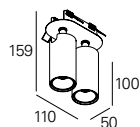

PB - Reflector brillante - 20°

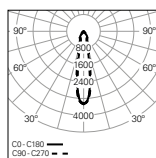

W	lm output	lm/W	mA	Ø	CÓDIGO*
10	1494	149	300	Ø45x105	90703L0020▲0♦20
17	2336	137	500	Ø45x105	90702L0020▲0♦20

PB - Reflector brillante - 50°

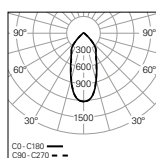

W	lm output	lm/W	mA	Ø	CÓDIGO*
10	1448	145	300	Ø45x105	90703L0020▲0♦50
17	2288	135	500	Ø45x105	90702L0020▲0♦50



*Sustituya los símbolos para completar el código

Color ▲
 Blanco W
 Negro B

Temp. de Color ♦
 3000K 3
 4000K 0

ELI 50 Spot / E 2

• Para completar el producto es necesario añadir driver LED. Por favor solicítelo por separado.

02. Seleccionar opciones

OPCIONES Código

Fuente de alimentación HF	
Driver 12,6W 10-42V 300mA HF	900003E
Driver 21W 10-42V 500mA HF	900007E

Fuente de alimentación DALI	
Driver 15,6W 09-52V 300mA DALI+ PUSH	900103H
Driver 26W 09-52V 500mA DALI+ PUSH	900107H

Cable de seguridad en acero	
L1500 mm	955010



Detalles del producto



Rotación de 355° y 90° de inclinación

ELI 50 Spot /C



Características del productos

Cuerpo

Aluminio



Acabado

Pintado en epoxi-poliéster

230V/50Hz

IP 20

Sistema óptico

PB - Reflector brillante

650°C

90°

355°

Fuente de luz

LED, RG1, CRI>90, MacAdam Step ≤3

Vida útil del LED

60.000h @ L80, B10, Ta 25°C

Fuente de alimentación

Driver LED 220-240V-50/60Hz incluido

01. Seleccionar versión



ELI 50 Spot /C

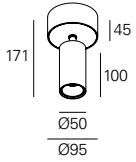

PB - Reflector brillante - 20°

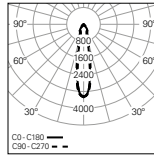

W	lm output	lm/W	CÓDIGO*
7	747	107	90701L100▼▲0◆20
11	1168	106	90700L100▼▲0◆20

PB - Reflector brillante - 50°

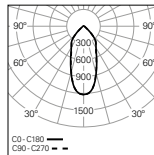

W	lm output	lm/W	CÓDIGO*
7	724	103	90701L100▼▲0◆50
11	1144	104	90700L100▼▲0◆50

*Sustituya los símbolos para completar el código

Fuente de alimentación ▼

HF	E
DALI	H

Color ▲

□ Blanco	W
■ Negro	B

Temp. de Color ◆

3000K	3
4000K	0



Detalles del producto



Rotación de 355° y 90° de inclinación

ELI 50 Spot Track



Características del productos

Cuerpo

Aluminio



Acabado

Pintado en epoxi-poliéster

230V/50Hz

IP 20

Sistema óptico

PB - Reflector brillante

650°C

90°

355°

Fuente de luz

LED, RG1, CRI>90, MacAdam Step ≤3

Vida útil del LED

60.000h @ L80, B10, Ta 25°C

Fuente de alimentación

Driver LED 220-240V-50/60Hz incluido

01. Seleccionar versión

ELI 50 Spot Track

HF

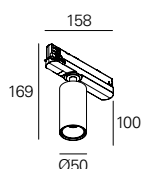

DALI

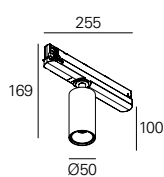

PB - Reflector brillante - 20°

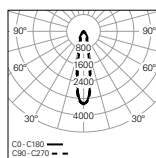

W

7

11

lm
output

747

1168

lm/W

106

106

CÓDIGO*

90699L100H▲0◆20

90698L100▼◆0◆20

PB - Reflector brillante - 50°

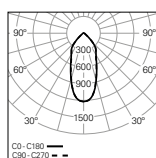

W

7

11

lm
output

724

1144

lm/W

103

104

CÓDIGO*

90699L100H▲0◆50

90698L100▼◆0◆50



*Sustituya los símbolos para completar el código

Fuente de alimentación ▼
HF E
DALI H

Color ▲
□ Blanco W
■ Negro B

Temp. de Color ◆
3000K 3
4000K 0

02. Seleccionar opciones

OPCIONES

Sistema de carril

- Ver página 800.



Detalles del producto



Rotación de 355° y 90° de inclinación

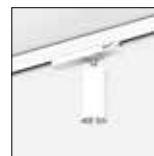

Acabado blanco







Iluminación
arquitectónica

ELI



ELI / E 1
328



ELI / E 2
330



ELI Sq / E 1
332

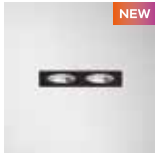

ELI Sq / E 2
334

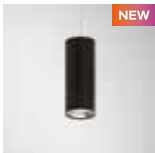

ELI
338



ELI Sq
340



ELI / C
342



ELI Sq / C
344



ELI / W
348



ELI Sq / W
350



ELI / W D/I
352



ELI Sq / W D/I
354



Tipos de aplicación





ELI /E 1



Características del productos

Cuerpo

Aluminio

**Acabado**

Pintado en epoxi-poliéster

**Sistema óptico**

PB - Reflector brillante

**Fuente de luz**

LED, RG1, CRI>90, MacAdam Step ≤3

Vida útil del LED

50.000h @ L90, B10, Ta 25°C

Fuente de alimentación

No incluida

Espesor del techo

Para techos entre 1-25 mm

01. Seleccionar versión



ELI / E 1

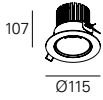

PB - Reflector brillante - 35°

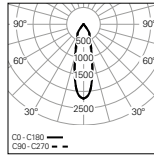

UGR	W	lm output	lm/W	mA	Ø	CÓDIGO*
≤19	5	706	141	150	Ø95	90661L0010▲0♦35
≤19	8	1161	145	250	Ø95	90654L0010▲0♦35

*Sustituya los símbolos para completar el código

Color	Symbol
Blanco	W
Negro	B

PB - Reflector brillante - 60°

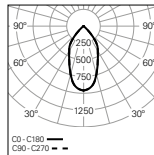

UGR	W	lm output	lm/W	mA	Ø	CÓDIGO*
≤22	5	706	141	150	Ø95	90661L0010▲0♦60
≤22	8	1161	145	250	Ø95	90654L0010▲0♦60

Temp. de Color	Symbol
3000K	3
4000K	0

ELI / E 1

• Para completar el producto es necesario añadir driver LED. Por favor solicítelo por separado.

02. Seleccionar opciones

OPCIONES Código

Fuente de alimentación HF	
Driver 6,3W 10-42V 150mA HF	900000E
Driver 10,5W 10-42V 250mA HF	900002E

Fuente de alimentación DALI	
Driver 7,8W 09-52V 150mA DALI+ PUSH	900100H
Driver 13W 09-52V 250mA DALI+ PUSH	900102H

Cable de seguridad en acero	
L1500 mm	955010

ELI / E 2



Características del productos

Cuerpo

Aluminio

**Acabado**

Pintado en epoxi-poliéster

**Sistema óptico**

PB - Reflector brillante

Fuente de luz

LED, RG1, CRI>90, MacAdam Step ≤3

**Vida útil del LED**

50.000h @ L90, B10, Ta 25°C

Fuente de alimentación

No incluida

Espesor del techo

Para techos entre 1-25 mm

01. Seleccionar versión



ELI / E 2

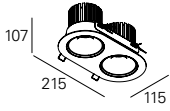

PB - Reflector brillante - 35°

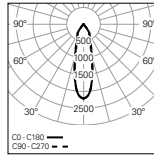

UGR	W	lm output	lm/W	mA	Ø	CÓDIGO*
≤19	10	1411	141	300	Ø95x195	90661L0020▲0♦35
≤19	16	2322	145	500	Ø95x195	90654L0020▲0♦35

PB - Reflector brillante - 60°

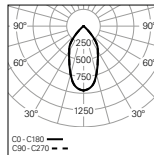

UGR	W	lm output	lm/W	mA	Ø	CÓDIGO*
≤22	10	1411	141	300	Ø95x195	90661L0020▲0♦60
≤22	16	2322	145	500	Ø95x195	90654L0020▲0♦60

*Sustituya los símbolos para completar el código

Color	Symbol
Blanco	W
Negro	B

Temp. de Color	Symbol
3000K	3
4000K	0

ELI / E 2

• Para completar el producto es necesario añadir driver LED. Por favor solicítelo por separado.

02. Seleccionar opciones

OPCIONES Código

Fuente de alimentación HF	
Driver 12,6W 10-42V 300mA HF	900003E
Driver 21W 10-42V 500mA HF	900007E

Fuente de alimentación DALI	
Driver 15,6W 09-52V 300mA DALI+ PUSH	900103H
Driver 26W 09-52V 500mA DALI+ PUSH	900107H

Cable de seguridad en acero	
L1500 mm	955010

ELI Sq /E 1



Características del productos

Cuerpo

Aluminio

**Acabado**

Pintado en epoxi-poliéster

**Sistema óptico**

PB - Reflector brillante

**Fuente de luz**

LED, RG1, CRI>90, MacAdam Step ≤3

Vida útil del LED

50.000h @ L90, B10, Ta 25°C

Fuente de alimentación

No incluida

Espesor del techo

Para techos entre 1-25 mm

01. Seleccionar versión

ELI Sq /E 1

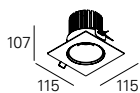

PB - Reflector brillante - 35°

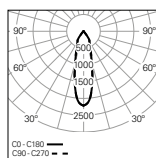

UGR	W	Im output	lm/W	mA	Ø	CÓDIGO*
≤19	5	706	141	150	Ø95	90673L0010▲0♦35
≤19	8	1161	145	250	Ø95	90655L0010▲0♦35

PB - Reflector brillante - 60°

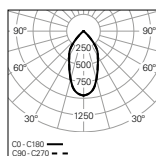

UGR	W	Im output	lm/W	mA	Ø	CÓDIGO*
≤22	5	706	141	150	Ø95	90673L0010▲0♦60
≤22	8	1161	145	250	Ø95	90655L0010▲0♦60



*Sustituya los símbolos para completar el código

Color	Symbol
Blanco	W
Negro	B

Temp. de Color	Symbol
3000K	3
4000K	0

ELI Sq /E 1

• Para completar el producto es necesario añadir driver LED. Por favor solicítelo por separado.

02. Seleccionar opciones

OPCIONES Código

Fuente de alimentación HF	
Driver 6,3W 10-42V 150mA HF	900000E
Driver 10,5W 10-42V 250mA HF	900002E

Fuente de alimentación DALI	
Driver 7,8W 09-52V 150mA DALI+ PUSH	900100H
Driver 13W 09-52V 250mA DALI+ PUSH	900102H

Cable de seguridad en acero	
L1500 mm	955010

ELI Sq /E 2



Características del productos

Cuerpo

Aluminio

**Acabado**

Pintado en epoxi-poliéster

**Sistema óptico**

PB - Reflector brillante

**Fuente de luz**

LED, RG1, CRI>90, MacAdam Step ≤3

Vida útil del LED

50.000h @ L90, B10, Ta 25°C

Fuente de alimentación

No incluida

Espesor del techo

Para techos entre 1-25 mm

01. Seleccionar versión

ELI Sq / E 2

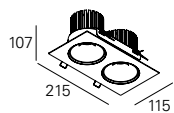

PB - Reflector brillante - 35°

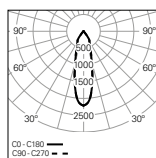

UGR	W	lm output	lm/W	mA	Ø	CODE*
≤19	10	1411	141	300	Ø95x195	90673L0020▲0♦35
≤19	16	2322	145	500	Ø95x195	90655L0020▲0♦35

PB - Reflector brillante - 60°

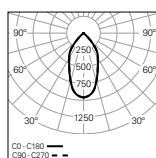

UGR	W	lm output	lm/W	mA	Ø	CODE*
≤22	10	1411	141	300	Ø95x195	90673L0020▲0♦60
≤22	16	2322	145	500	Ø95x195	90655L0020▲0♦60



*Sustituya los símbolos para completar el código

Color ▲
 Blanco W
 Negro B

Temp. de Color ♦
 3000K 3
 4000K 0

ELI Sq / E 2

• Para completar el producto es necesario añadir driver LED. Por favor solicítelo por separado.

02. Seleccionar opciones

OPCIONES Código

Fuente de alimentación HF	
Driver 12,6W 10-42V 300mA HF	900003E
Driver 21W 10-42V 500mA HF	900007E

Fuente de alimentación DALI	
Driver 15,6W 09-52V 300mA DALI+ PUSH	900103H
Driver 26W 09-52V 500mA DALI+ PUSH	900107H

Cable de seguridad en acero	
L1500 mm	955010







Características del productos

Cuerpo

Aluminio

**Acabado**

Pintado en epoxi-poliéster

230V/50Hz

Sistema óptico

PB - Reflector brillante

**Fuente de luz**

LED, RG1, CRI>90, MacAdam Step ≤3

Vida útil del LED

50.000h @ L90, B10, Ta 25°C

650°C

Fuente de alimentación

Driver LED 220-240V-50/60Hz incluido

01. Seleccionar versión

ELI

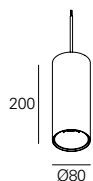

PB - Reflector brillante - 35°

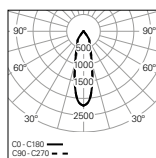

UGR	W	lm output	lm/W	CÓDIGO*
≤19	6	706	118	90671L200▼▲0♦35
≤19	9	1161	129	90564L200▼▲0♦35

PB - Reflector brillante - 60°

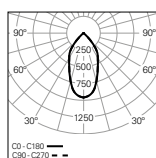

UGR	W	lm output	lm/W	CÓDIGO*
≤22	6	706	118	90671L200▼▲0♦60
≤22	9	1161	129	90564L200▼▲0♦60



*Sustituya los símbolos para completar el código

Fuente de alimentación ▼
 HF E
 DALI H

Color ▲
 Blanco W
 Negro B

Temp. de Color ♦
 3000K 3
 4000K 0

ELI

• Para completar el producto es necesario pedir el cable y la base de alimentación por separado.

02. Seleccionar opciones



*Sustituya los símbolos para completar el código

OPCIONES Código*

Cable de alimentación transparente

L1500 mm - 3 x 0,75 mm ²	940400
L1500 mm - 5 x 0,75 mm ²	940500
L3000 mm - 3 x 0,75 mm ²	940401
L3000 mm - 5 x 0,75 mm ²	940501
L6000 mm - 3 x 0,75 mm ²	940402
L6000 mm - 5 x 0,75 mm ²	940507

Base circular

Superficie T24 D95	45 Ø95	978600▲
Empotrar T5 D90	Ø70 33 Ø90	971300▲

Color ▲
 Blanco W
 Negro B



Detalles del producto



Base de techo

ELI Sq

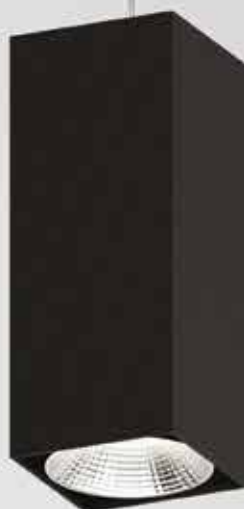

Características del productos

Cuerpo

Aluminio

**Acabado**

Pintado en epoxi-poliéster

230V/50Hz

Sistema óptico

PB - Reflector brillante



IP 20

Fuente de luz

LED, RG1, CRI>90, MacAdam Step ≤3

Vida útil del LED

50.000h @ L90, B10, Ta 25°C

650°C

Fuente de alimentación

Driver LED 220-240V-50/60Hz incluido

01. Seleccionar versión

ELI Sq

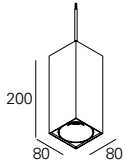

PB - Reflector brillante - 35°

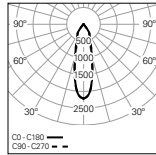

UGR	W	lm output	lm/W	CÓDIGO*
≤19	6	706	118	90676L200▼▲0◆35
≤19	9	1161	129	90566L200▼▲0◆35

PB - Reflector brillante - 60°

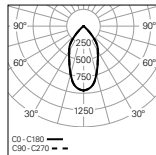

UGR	W	lm output	lm/W	CÓDIGO*
≤22	6	706	118	90676L200▼▲0◆60
≤22	9	1161	129	90566L200▼▲0◆60



*Sustituya los símbolos para completar el código

Fuente de alimentación ▼
 HF E
 DALI H

Color ▲
 □ Blanco W
 ■ Negro B

Temp. de Color ◆
 3000K 3
 4000K 0

ELI Sq

• Para completar el producto es necesario pedir el cable y la base de alimentación por separado.

02. Seleccionar opciones

OPCIONES Código*

Cable de alimentación transparente

L1500 mm - 3 x 0,75 mm ²	940400
L1500 mm - 5 x 0,75 mm ²	940500
L3000 mm - 3 x 0,75 mm ²	940401
L3000 mm - 5 x 0,75 mm ²	940501
L6000 mm - 3 x 0,75 mm ²	940402
L6000 mm - 5 x 0,75 mm ²	940507

Base cuadrada

Superficie T25 Q100	45 100	978610▲
Empotrar T7 Q90	Ø70 35 90	971400▲



*Sustituya los símbolos para completar el código

Color ▲
 □ Blanco W
 ■ Negro B



Detalles del producto

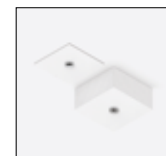

Base de techo

ELI /C



Características del productos

Cuerpo

Aluminio

**Acabado**

Pintado en epoxi-poliéster

230V/50Hz

Sistema óptico

PB - Reflector brillante



IP 20

Fuente de luz

LED, RG1, CRI>90, MacAdam Step ≤3

Vida útil del LED

50.000h @ L90, B10, Ta 25°C

650°C

Fuente de alimentación

Driver LED 220-240V-50/60Hz incluido

01. Seleccionar versión



ELI / C

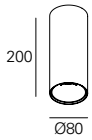

PB - Reflector brillante - 35°

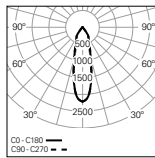

UGR	W	lm output	lm/W	CÓDIGO*
≤19	6	706	118	90347L200▼▲0◆35
≤19	9	1161	129	90596L200▼▲0◆35

PB - Reflector brillante - 60°

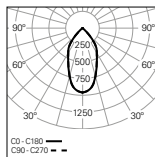

UGR	W	lm output	lm/W	CÓDIGO*
≤22	6	706	118	90347L200▼▲0◆60
≤22	9	1161	129	90596L200▼▲0◆60

*Sustituya los símbolos para completar el código

Fuente de alimentación ▼
 HF E
 DALI H

Color ▲
 □ Blanco W
 ■ Negro B

Temp. de Color ◆
 3000K 3
 4000K 0

ELI Sq /C



Características del productos

Cuerpo

Aluminio

Acabado

Pintado en epoxi-poliéster

Sistema óptico

PB - Reflector brillante

Fuente de luz

LED, RG1, CRI>90, MacAdam Step ≤3

Vida útil del LED

50.000h @ L90, B10, Ta 25°C

Fuente de alimentación

Driver LED 220-240V-50/60Hz incluido



230V/50Hz



IP 20

650°C

01. Seleccionar versión



ELI Sq /C

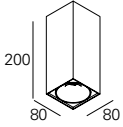

PB - Reflector brillante - 35°

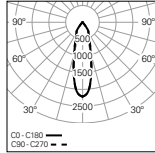

UGR	W	lm output	lm/W	CÓDIGO*
≤19	6	706	118	90672L200▼▲0◆35
≤19	9	1161	129	90598L200▼▲0◆35

PB - Reflector brillante - 60°

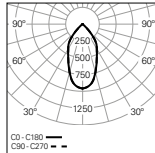

UGR	W	lm output	lm/W	CÓDIGO*
≤22	6	706	118	90672L200▼▲0◆60
≤22	9	1161	129	90598L200▼▲0◆60

*Sustituya los símbolos para completar el código

Fuente de alimentación ▼
 HF E
 DALI H

Color ▲
 □ Blanco W
 ■ Negro B

Temp. de Color ◆
 3000K 3
 4000K 0





ELI /W



Características del productos

Cuerpo

Aluminio

Acabado

Pintado en epoxi-poliéster

Sistema óptico

PB - Reflector brillante

Fuente de luz

LED, RG1, CRI>90, MacAdam Step ≤3

Vida útil del LED

50.000h @ L90, B10, Ta 25°C

Fuente de alimentación

Driver LED 220-240V-50/60Hz incluido



230V/50Hz



IP 20

650°C

01. Seleccionar versión

ELI /W

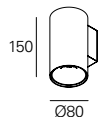

PB - Reflector brillante - 35°

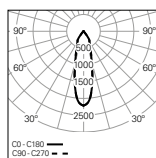

W
6
9

lm
output
706
1161

lm/W
118
129

CÓDIGO*

90670L150▼▲0◆35
90646L150▼▲0◆35

*Sustituya los símbolos para completar el código

Fuente de alimentación ▼
HF E
DALI H

Color ▲
□ Blanco W
■ Negro B

PB - Reflector brillante - 60°

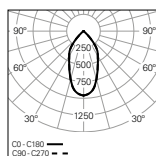

W
6
9

lm
output
706
1161

lm/W
118
129

CÓDIGO*

90670L150▼▲0◆60
90646L150▼▲0◆60

Temp. de Color ◆
3000K 3
4000K 0

ELI Sq /W



Características del productos

Cuerpo

Aluminio

Acabado

Pintado en epoxi-poliéster

Sistema óptico

PB - Reflector brillante

Fuente de luz

LED, RG1, CRI>90, MacAdam Step ≤3

Vida útil del LED

50.000h @ L90, B10, Ta 25°C

Fuente de alimentación

Driver LED 220-240V-50/60Hz incluido



230V/50Hz



IP 20

650°C

01. Seleccionar versión



ELI Sq /W

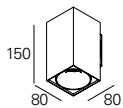

PB - Reflector brillante - 35°

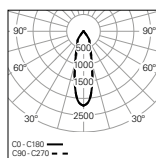

W
6
9

lm output
706
1161

lm/W
118
129

CÓDIGO*

90675L150▼▲0◆35
90648L150▼▲0◆35

*Sustituya los símbolos para completar el código

Fuente de alimentación ▼
HF E
DALI H

Color ▲
□ Blanco W
■ Negro B

PB - Reflector brillante - 60°

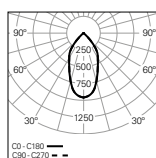

W
6
9

lm output
706
1161

lm/W
118
129

CÓDIGO*

90675L150▼▲0◆60
90648L150▼▲0◆60

Temp. de Color ◆
3000K 3
4000K 0

ELI /W D/I



Características del productos

Cuerpo

Aluminio

Acabado

Pintado en epoxi-poliéster

Sistema óptico

PB - Reflector brillante

Fuente de luz

LED, RG1, CRI>90, MacAdam Step ≤3

Vida útil del LED

50.000h @ L90, B10, Ta 25°C

Fuente de alimentación

Driver LED 220-240V-50/60Hz incluido



230V/50Hz



IP 20

650°C

01. Seleccionar versión



ELI /W D/I

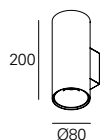

PB - Reflector brillante - 35°

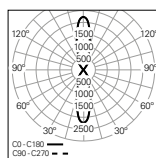

W
10

lm output
1258

lm/W
126

CÓDIGO*
90651L200▼▲0◆35

PB - Reflector brillante - 60°

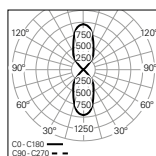

W
10

lm output
1244

lm/W
124

CÓDIGO*
90651L200▼▲0◆60

*Sustituya los símbolos para completar el código

Fuente de alimentación ▼
HF E
DALI H

Color ▲
□ Blanco W
■ Negro B

Temp. de Color ◆
3000K 3
4000K 0

ELI Sq /W D/I



Características del productos

Cuerpo

Aluminio

Acabado

Pintado en epoxi-poliéster

Sistema óptico

PB - Reflector brillante

Fuente de luz

LED, RG1, CRI>90, MacAdam Step ≤3

Vida útil del LED

50.000h @ L90, B10, Ta 25°C

Fuente de alimentación

Driver LED 220-240V-50/60Hz incluido



230V/50Hz



IP 20

650°C

01. Seleccionar versión



ELI Sq /W D/I

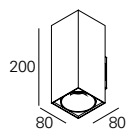

PB - Reflector brillante - 35°

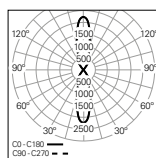

W
10

lm output
1258

lm/W
126

CÓDIGO*
90653L200▼▲0◆35

PB - Reflector brillante - 60°

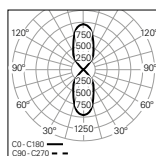

W
10

lm output
1244

lm/W
124

CÓDIGO*
90653L200▼▲0◆60

*Sustituya los símbolos para completar el código

Fuente de alimentación ▼
HF E
DALI H

Color ▲
□ Blanco W
■ Negro B

Temp. de Color ◆
3000K 3
4000K 0



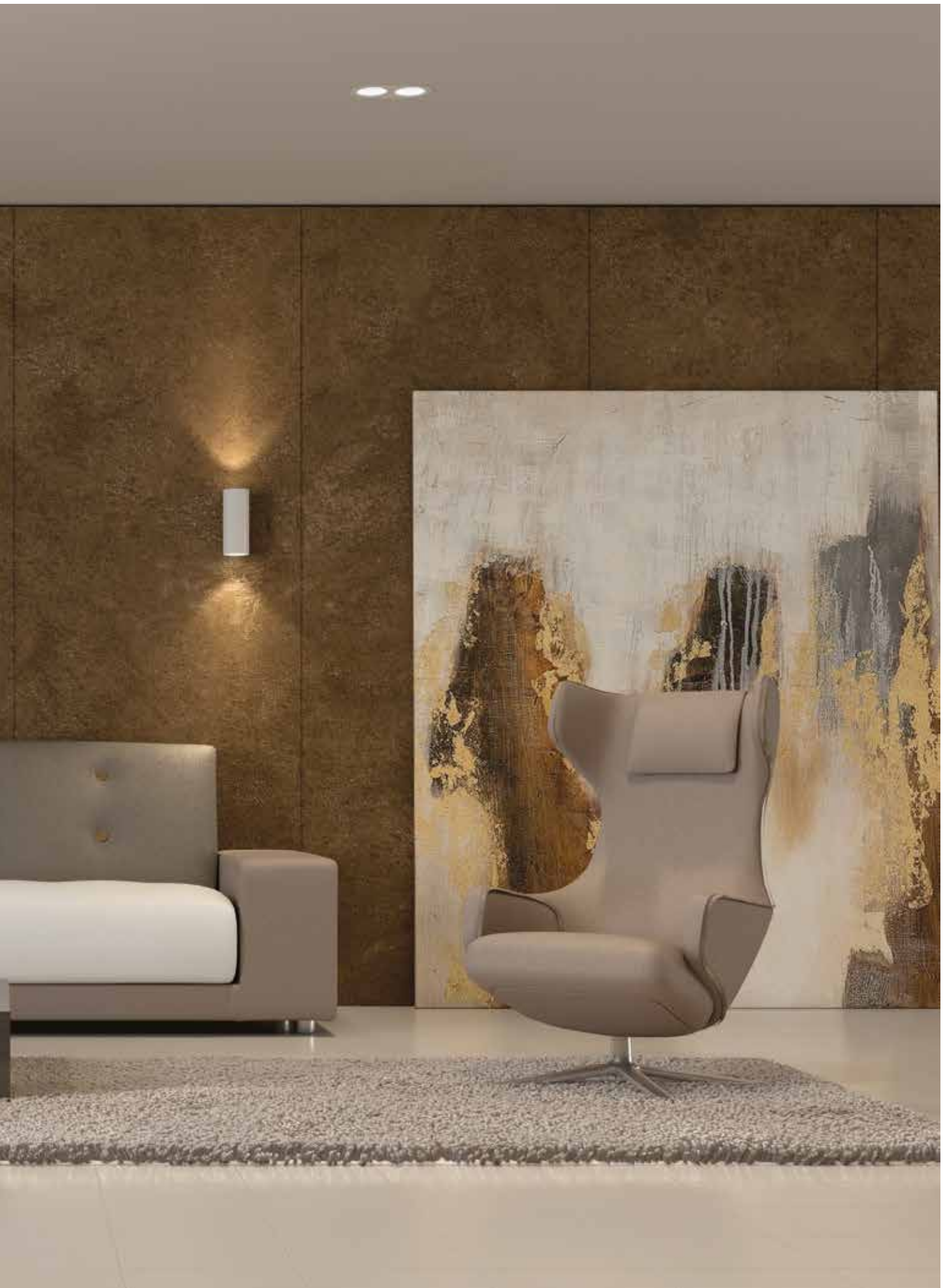



Iluminación
arquitectónica

FOCUS 2



FOCUS 2
360



FOCUS 2



Características del producto

Cuerpo
Aluminio

Acabado

Pintado en epoxi-poliéster

Sistema óptico

SPOT
FLOOD
WIDE FLOOD
EXTRA WIDE

Fuente de luz

LED, RG1, CRI>80, MacAdam Step ≤3

Vida útil del LED

50.000h @ L80, B10, Ta 25°C

Fuente de alimentación

Driver LED 220-240VAC-50/60Hz
con adaptador de carril incluido

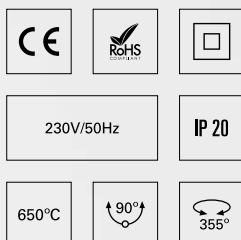

01. Seleccionar versión



FOCUS 2

HF

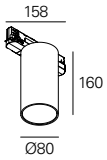

SPOT - Ángulo de apertura - 15°

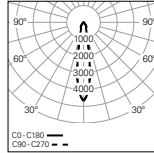

UGR	W	lm output	lm/W	CÓDIGO*
≤19	9	1082	120	90768L080▼▲◆15
≤22	15	2071	138	90791L080▼▲◆15
≤22	23	3068	133	90763L080▼▲◆15

*Sustituya los símbolos para completar el código

Fuente de alimentación ▼

HF	E
DALI	H

Color ▲

□ Blanco	W
■ Negro	B

DALI

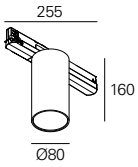

FLOOD - Ángulo de apertura - 25°

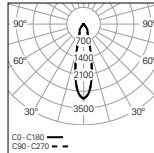

UGR	W	lm output	lm/W	CÓDIGO*
≤19	9	1057	117	90768L080▼▲◆25
≤22	15	2047	136	90791L080▼▲◆25
≤22	23	3033	132	90763L080▼▲◆25

Temp. de Color ◆

3000K CRI>80	3
4000K CRI>80	0
3000K CRI>90	B
4000K CRI>90	A

WIDE FLOOD - Ángulo de apertura - 40°

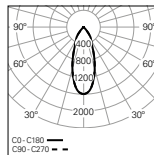

UGR	W	lm output	lm/W	CÓDIGO*
≤19	9	1045	116	90768L080▼▲◆40
≤22	15	2023	135	90791L080▼▲◆40
≤22	23	3033	132	90763L080▼▲◆40

EXTRA WIDE - Ángulo de apertura - 60°

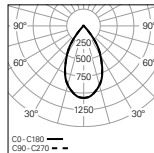

UGR	W	lm output	lm/W	CÓDIGO*
≤22	9	1045	116	90768L080▼▲◆60
≤22	15	1999	133	90791L080▼▲◆60
≤25	23	2998	130	90763L080▼▲◆60

02. Seleccionar opciones



Detalles del producto

OPCIONES

Sistema de carril

• Ver página 800.



Acabado blanco



Sistema óptico



Adaptador



VEGA



VEGA /E
366



VEGA Sq /E
368



VEGA
372



VEGA Sq
374



VEGA IP /E
378



VEGA Sq IP /E
380



VEGA IP
382



Tipos de aplicación

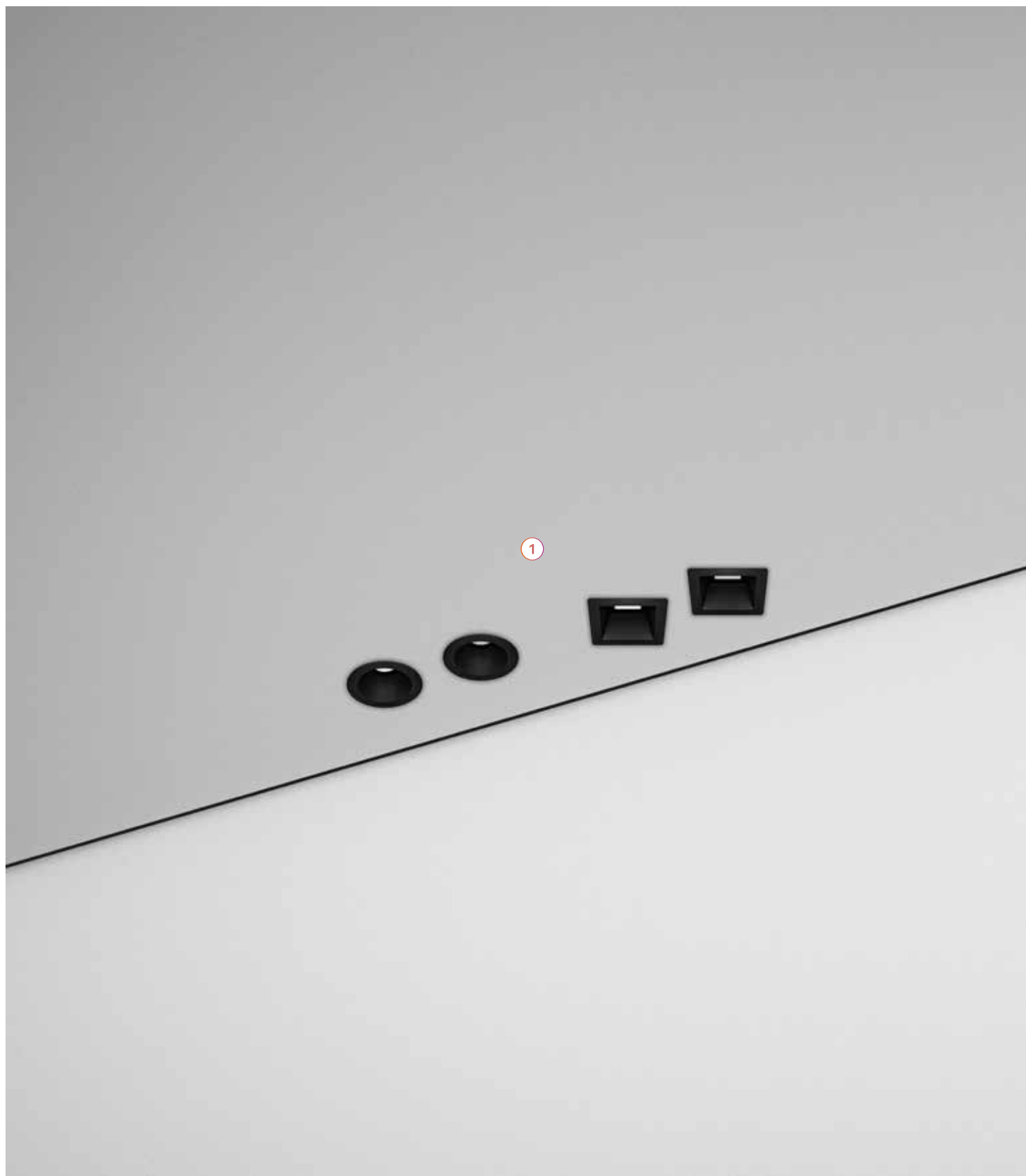

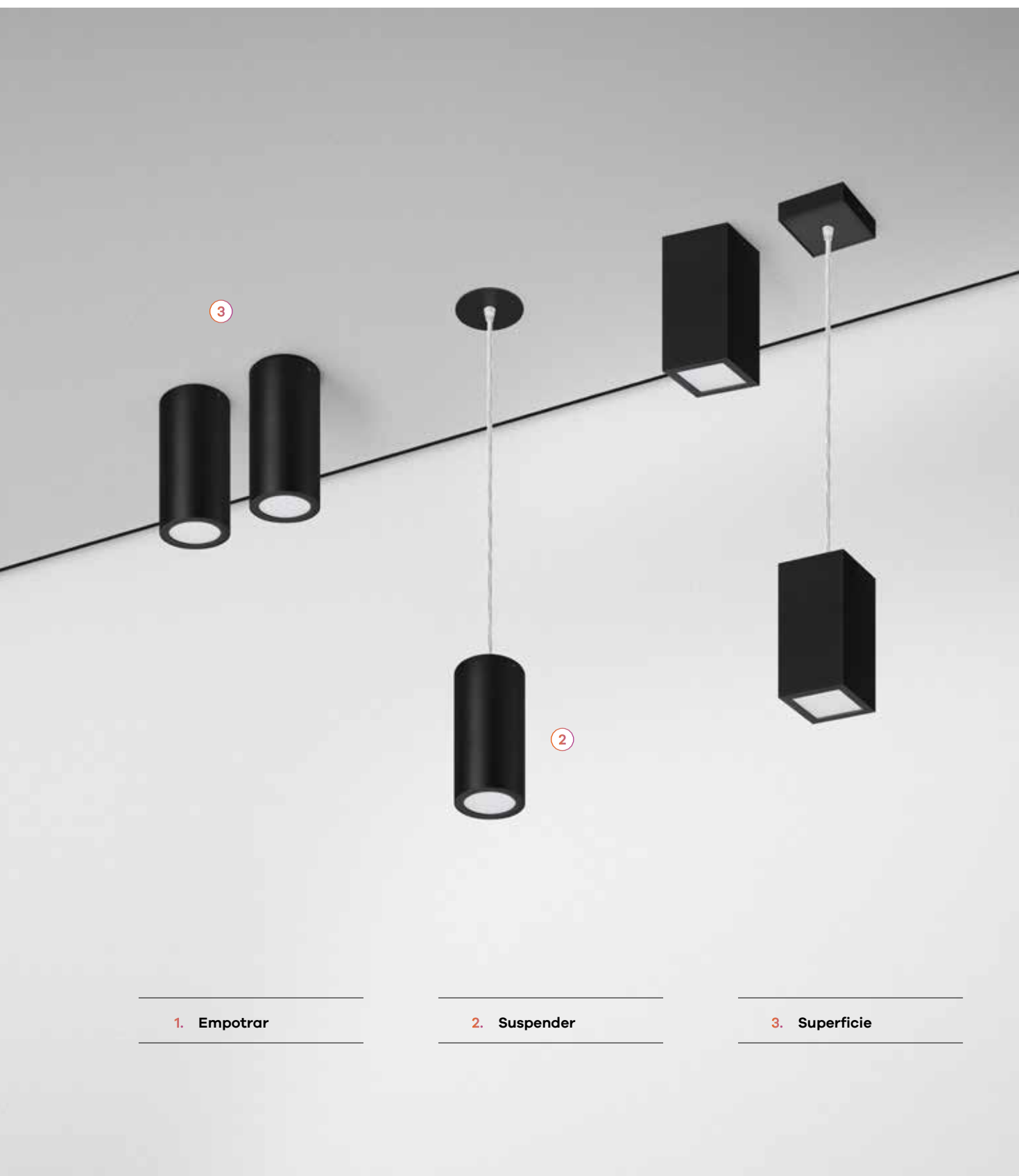

1. Empotrar

2. Suspender

3. Superficie

VEGA /E



Características del productos

Cuerpo

ABS inyectado y disipador de aluminio

Acabado

Pintado en epoxi-poliéster

Sistema óptico

PRISM+ - Difusor microprismático
LIGHT+ - Difusor opalino

Fuente de luz

LED, CRI>90, MacAdam Step ≤3

Vida útil del LED

50.000h @ L90, B10, Ta 25°C

Fuente de alimentación

No incluida

Espesor del techo

Para techos entre 1-25 mm



01. Seleccionar versión

VEGA /E



110

Ø100

PRISM+ - Difusor microprismático

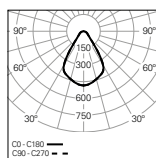

UGR	W	lm output	lm/W	mA	Ø	CÓDIGO*
≤19	7	701	100	200	Ø85	90441L0080▲0◆00
≤22	8	856	107	250	Ø85	90441L0110▲0◆00
≤22	12	1152	96	350	Ø85	90441L0150▲0◆00

C0-C180

C90-C270

LIGHT+ - Difusor opalino

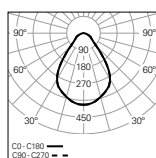

UGR	W	lm output	lm/W	mA	Ø	CÓDIGO*
≤22	7	649	93	200	Ø85	90430L0080▲0◆00
≤22	8	791	99	250	Ø85	90430L0110▲0◆00
≤22	12	1082	90	350	Ø85	90430L0150▲0◆00

C0-C180

C90-C270



*Sustituya los símbolos para completar el código

Color ▲
 Blanco W
 Negro B

Temp. de Color ◆
 3000K 3
 4000K 0

VEGA /E

• Para completar el producto es necesario añadir driver LED. Por favor solicítelo por separado.

02. Seleccionar opciones

OPCIONES Código

Fuente de alimentación HF

Driver 8,4W 10-42V 200mA HF	900001E
Driver 10,5W 10-42V 250mA HF	900002E
Driver 14,7W 10-42V 350mA HF	900004E

Fuente de alimentación DALI

Driver 10,4W 09-52V 200mA DALI+ PUSH	900101H
Driver 13W 09-52V 250mA DALI+ PUSH	900102H
Driver 18,2W 09-52V 350mA DALI+ PUSH	900104H

Cable de seguridad en acero

L 1500 mm	955010
-----------	--------



Detalles del producto



Acabado blanco

VEGA Sq /E



Características del productos

Cuerpo

ABS inyectado y disipador de aluminio

Acabado

Pintado en epoxi-poliéster

Sistema óptico

PRISM+ - Difusor microprismático
LIGHT+ - Difusor opalino

Fuente de luz

LED, CRI>90, MacAdam Step ≤3

Vida útil del LED

50.000h @ L90, B10, Ta 25°C

Fuente de alimentación

No incluida

Espesor del techo

Para techos entre 1-25 mm



01. Seleccionar versión

VEGA Sq /E

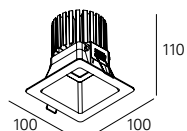

PRISM+ - Difusor microprismático

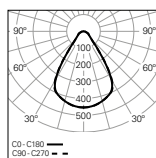

UGR	W	lm output	lm/W	mA	Φ	CÓDIGO*
≤19	7	712	102	200	85x85	90442L0080▲0◆00
≤19	8	869	109	250	85x85	90442L0110▲0◆00
≤22	12	1170	98	350	85x85	90442L0150▲0◆00

LIGHT+ - Difusor opalino

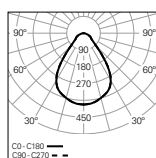

UGR	W	lm output	lm/W	mA	Φ	CÓDIGO*
≤19	7	701	100	200	85x85	90437L0080▲0◆00
≤22	8	856	107	250	85x85	90437L0110▲0◆00
≤22	12	1152	96	350	85x85	90437L0150▲0◆00

VEGA Sq /E

• Para completar el producto es necesario añadir driver LED. Por favor solicítelo por separado.



*Sustituya los símbolos para completar el código

Color ▲
 Blanco W
 Negro B

Temp. de Color ◆
 3000K 3
 4000K 0

02. Seleccionar opciones

OPCIONES Código

Fuente de alimentación HF

Driver 8,4W 10-42V 200mA HF	900001E
Driver 10,5W 10-42V 250mA HF	900002E
Driver 14,7W 10-42V 350mA HF	900004E

Fuente de alimentación DALI

Driver 10,4W 09-52V 200mA DALI+ PUSH	900101H
Driver 13W 09-52V 250mA DALI+ PUSH	900102H
Driver 18,2W 09-52V 350mA DALI+ PUSH	900104H

Cable de seguridad en acero

L 1500 mm	955010
-----------	--------



Detalles del producto



Acabado blanco





VEGA



Características del productos

Cuerpo

Aluminio

Acabado

Pintado en epoxi-poliéster

Sistema óptico

PRISM+ - Difusor microprismático
LIGHT+ - Difusor opalino

Fuente de luz

LED, CRI>90, MacAdam Step ≤3

Vida útil del LED

50.000h @ L90, B10, Ta 25°C

Fuente de alimentación

Driver LED 220-240V-50/60Hz incluido



230V/50Hz



IP 40

650°C

01. Seleccionar versión



VEGA

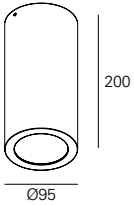

PRISM+ - Difusor microprismático

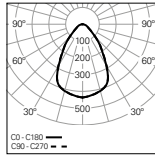

UGR	W	lm output	lm/W	CÓDIGO*
≤19	8	681	85	90445L008▼▲0◆00
≤19	9	843	94	90445L011▼▲0◆00
≤22	14	1152	82	90445L015▼▲0◆00

LIGHT+ - Difusor opalino

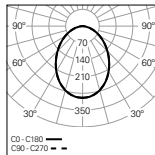

UGR	W	lm output	lm/W	CÓDIGO*
≤22	8	691	86	90443L008▼▲0◆00
≤22	9	856	95	90443L011▼▲0◆00
≤25	14	1152	82	90443L015▼▲0◆00

*Sustituya los símbolos para completar el código

Fuente de alimentación	
HF	E
DALI	H

Color	
□ Blanco	W
■ Negro	B

Temp. de Color	
3000K	3
4000K	0

VEGA

• Para la versión suspendida es necesario pedir la base de alimentación por separado.

02. Seleccionar base de alimentación



Empotrar

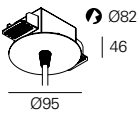

HF	CÓDIGO*
Ø95	912620▲

DALI	CÓDIGO*
Ø95	912630▲

Superficie

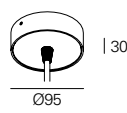

HF	CÓDIGO*
Ø95	912600▲

DALI	CÓDIGO*
Ø95	912610▲

*Sustituya los símbolos para completar el código

Color	
□ Blanco	W
■ Negro	B

BASE DE ALIMENTACIÓN

• Cable de alimentación transparente com L1500 mm incluido.

VEGA Sq



Características del productos

Cuerpo

Aluminio

Acabado

Pintado en epoxi-poliéster

Sistema óptico

PRISM+ - Difusor microprismático
LIGHT+ - Difusor opalino

Fuente de luz

LED, CRI>90, MacAdam Step ≤3

Vida útil del LED

50.000h @ L90, B10, Ta 25°C

Fuente de alimentación

Driver LED 220-240V-50/60Hz incluido



230V/50Hz



IP 40

650°C

01. Seleccionar versión



VEGA Sq

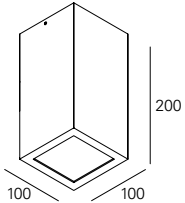

PRISM+ - Difusor microprismático

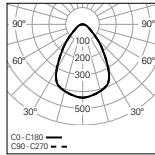

UGR	W	lm output	lm/W	CÓDIGO*
≤19	8	743	93	90446L008▼▲0◆00
≤19	9	908	101	90446L011▼▲0◆00
≤22	14	1241	89	90446L015▼▲0◆00

LIGHT+ - Difusor opalino

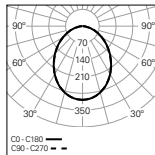

UGR	W	lm output	lm/W	CÓDIGO*
≤22	8	743	93	90444L008▼▲0◆00
≤22	9	921	102	90444L011▼▲0◆00
≤25	14	1259	90	90444L015▼▲0◆00

*Sustituya los símbolos para completar el código

Fuente de alimentación	
HF	E
DALI	H

Color	
□ Blanco	W
■ Negro	B

Temp. de Color	
3000K	3
4000K	0

VEGA Sq

• Para la versión suspendida es necesario pedir la base de alimentación por separado.

02. Seleccionar base de alimentación



Empotrar

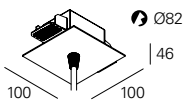

HF

100x100 **CÓDIGO***
912720▲

DALI

100x100 **CÓDIGO***
912730▲

Superficie

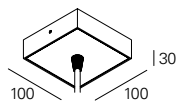

HF

100x100 **CÓDIGO***
912700▲

DALI

100x100 **CÓDIGO***
912710▲

*Sustituya los símbolos para completar el código

Color	
□ Blanco	W
■ Negro	B

BASE DE ALIMENTACIÓN

• Cable de alimentación transparente com L1500 mm incluido.

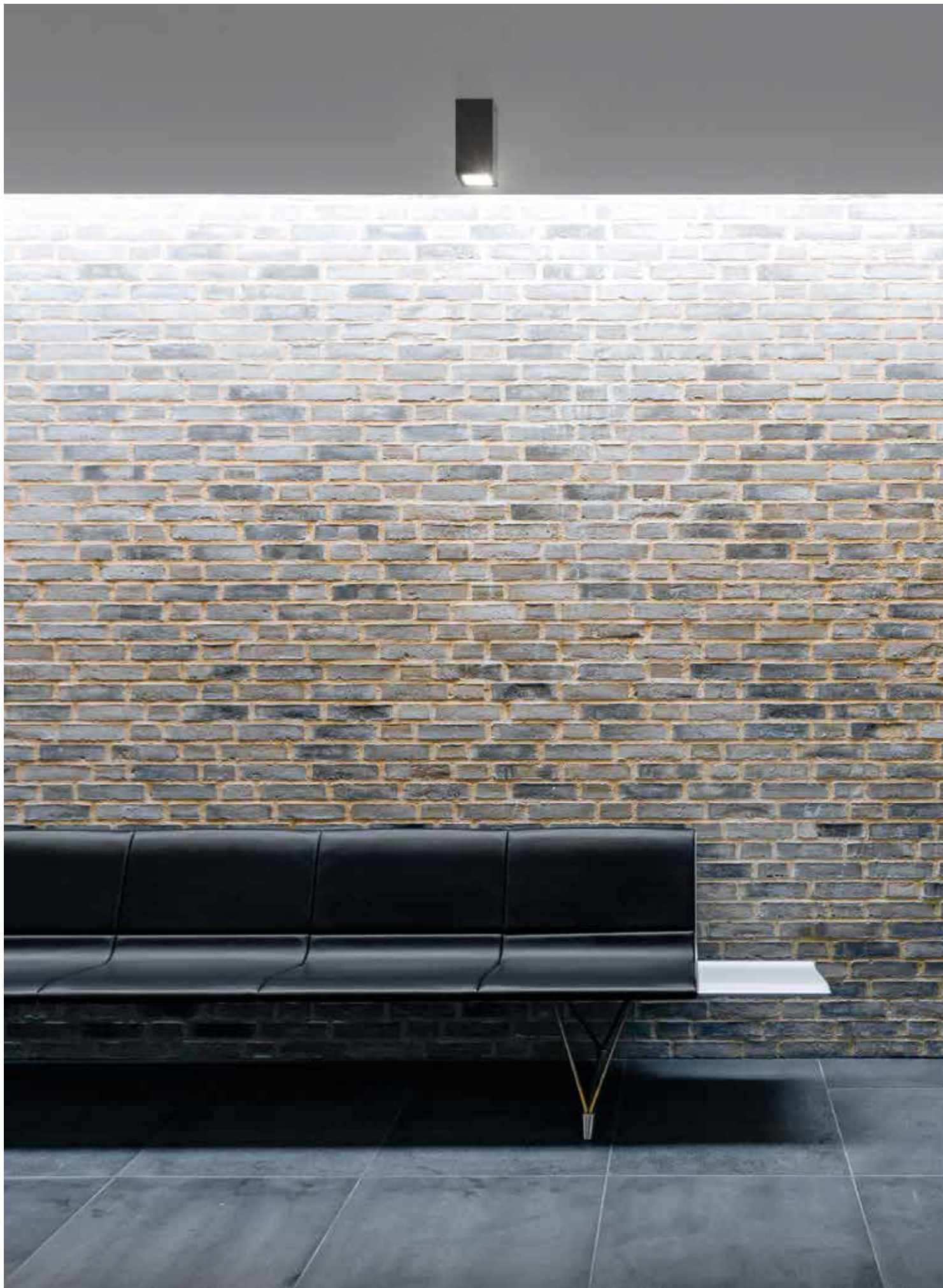



VEGA IP /E



Características del productos

Cuerpo

ABS inyectado y disipador de aluminio



Acabado

Pintado en epoxi-poliéster



Sistema óptico

LIGHT+ - Difusor opalino



Fuente de luz

LED, CRI>90, MacAdam Step ≤3

Vida útil del LED

50.000h @ L90, B10, Ta 25°C



Fuente de alimentación

No incluida

Espesor del techo

Para techos entre 1-25 mm

01. Seleccionar versión

VEGA IP / E

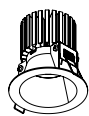

110

Ø100

LIGHT+ - Difusor opalino

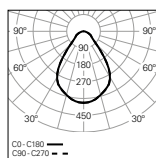

W	lm output	lm/W	mA	Ø	CÓDIGO*
7	649	93	200	Ø85	90575L0080▲0◆00
8	791	99	250	Ø85	90575L0110▲0◆00
12	1082	90	350	Ø85	90575L0150▲0◆00



*Sustituya los símbolos para completar el código

Color ▲
 Blanco W
 Negro B

Temp. de Color ◆
 3000K 3
 4000K 0

VEGA IP / E

• Para completar el producto es necesario añadir driver LED. Por favor solicítelo por separado.

02. Seleccionar opciones

OPCIONES Código

Fuente de alimentación HF

Driver 8,4W 10-42V 200mA HF	900001E
Driver 10,5W 10-42V 250mA HF	900002E
Driver 14,7W 10-42V 350mA HF	900004E

Fuente de alimentación DALI

Driver 10,4W 09-52V 200mA DALI+ PUSH	900101H
Driver 13W 09-52V 250mA DALI+ PUSH	900102H
Driver 18,2W 09-52V 350mA DALI+ PUSH	900104H

Cable de seguridad en acero

L 1500 mm	955010
-----------	--------



Detalles del producto



Acabado blanco

VEGA Sq IP /E



Características del productos

Cuerpo

ABS inyectado y disipador de aluminio



Acabado

Pintado en epoxi-poliéster



Sistema óptico

LIGHT+ - Difusor opalino



Fuente de luz

LED, CRI>90, MacAdam Step ≤3

Vida útil del LED

50.000h @ L90, B10, Ta 25°C



Fuente de alimentación

No incluida

Espesor del techo

Para techos entre 1-25 mm

01. Seleccionar versión

VEGA Sq IP /E

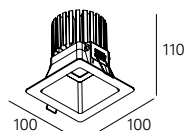

LIGHT+ - Difusor opalino

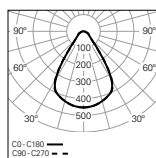

W	Im output	lm/W	mA	Φ	CÓDIGO*
7	701	100	200	85x85	90569L0080▲0◆00
8	856	107	250	85x85	90569L0110▲0◆00
12	1152	96	350	85x85	90569L0150▲0◆00



*Sustituya los símbolos para completar el código

Color ▲
 Blanco W
 Negro B

Temp. de Color ◆
 3000K 3
 4000K 0

VEGA IP Sq /E

• Para completar el producto es necesario añadir driver LED. Por favor solicítelo por separado.

02. Seleccionar opciones

OPCIONES Código

Fuente de alimentación HF

Driver 8,4W 10-42V 200mA HF	900001E
Driver 10,5W 10-42V 250mA HF	900002E
Driver 14,7W 10-42V 350mA HF	900004E

Fuente de alimentación DALI

Driver 10,4W 09-52V 200mA DALI+ PUSH	900101H
Driver 13W 09-52V 250mA DALI+ PUSH	900102H
Driver 18,2W 09-52V 350mA DALI+ PUSH	900104H

Cable de seguridad en acero

L 1500 mm	955010
-----------	--------



Detalles del producto



Acabado blanco

VEGA IP



Características del productos

Cuerpo

Aluminio

**Acabado**

Pintado en epoxi-poliéster

230V/50Hz

Sistema óptico

LIGHT+ - Difusor opalino

**Fuente de luz**

LED, CRI>90, MacAdam Step ≤3

Vida útil del LED

50.000h @ L90, B10, Ta 25°C

**Fuente de alimentación**

Driver LED 220-240V-50/60Hz incluido

01. Seleccionar versión



VEGA IP

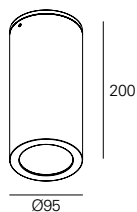

LIGHT+ - Difusor opalino

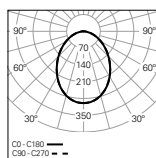

W	lm output	lm/W	CÓDIGO*
8	691	86	90447L008▼▲0◆00
9	856	95	90447L011▼▲0◆00
14	1152	82	90447L015▼▲0◆00

*Sustituya los símbolos para completar el código

Fuente de alimentación	
HF	E
DALI	H

Color	
□ Blanco	W
■ Negro	B

Temp. de Color	
3000K	3
4000K	0

Detalles del producto



Acabado blanco







HOLI



HOLI Sq /T Mini
388



HOLI Sq /T
390



HOLI Sq /T Max
392



HOLI Sq Mini
396



HOLI Sq
398

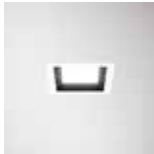

HOLI Sq Max
400



HOLI Sq /AS Max
404



HOLI Sq /C Mini
406



HOLI Sq /C
408



HOLI Sq /C Max
410



HOLI Sq /T Mini



Características del productos

Cuerpo

Chapa de acero



Acabado

Pintado en epoxi-poliéster

230V/50Hz

Sistema de fijación

Premarco trimless



Sistema óptico

PRISM+ - Difusor microprismático
LIGHT+ - Difusor opalino

Fuente de luz

LED, RG1, CRI>80, MacAdam Step ≤3



Vida útil del LED

60.000h @ L70, B10, Ta 25°C

Fuente de alimentación

No incluida

01. Seleccionar versión

HOLI Sq /T Mini

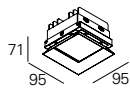

PRISM+ - Difusor microprismático

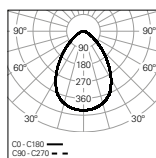

W	lm output	lm/W	mA	Size	CÓDIGO*
7	759	115	200	101x101	90222L1070▲0◆00

LIGHT+ - Difusor opalino

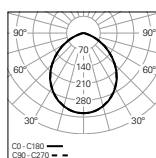

W	lm output	lm/W	mA	Size	CÓDIGO*
7	837	120	200	101x101	90267L1070▲0◆00



*Sustituya los símbolos para completar el código

Color	Symbol
Blanco	W
Negro	B

Temp. de Color	Symbol
3000K	3
4000K	0

HOLI Sq /T Mini

• Para completar el producto es necesario añadir driver LED. Por favor solicítelo por separado.

02. Seleccionar opciones

OPCIONES	Código
Fuente de alimentación HF Driver 8,4W 10-42V 200mA HF	900001E
Fuente de alimentación DALI Driver 10,4W 09-52V 200mA DALI+ PUSH	900101H
Premarco Blanco	971500
	
Cable de seguridad en acero L1500 mm	955000



Detalles del producto



Acabado blanco

Acabado negro

HOLI Sq /T



Características del producto

Cuerpo

Chapa de acero



Acabado

Pintado en epoxi-poliéster

230V/50Hz

Sistema de fijación

Premarco trimless



Sistema óptico

PRISM+ - Difusor microprismático
LIGHT+ - Difusor opalino

Fuente de luz

LED, RG1, CRI>80, MacAdam Step ≤3



Vida útil del LED

60.000h @ L70, B10, Ta 25°C

Fuente de alimentación

No incluida

01. Seleccionar versión

HOLI Sq /T

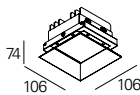

PRISM+ - Difusor microprismático

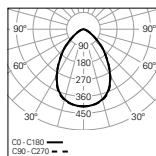

W	lm output	lm/W	mA	Size	CÓDIGO*
7	748	107	200	114x114	90223L1060▲0◆00
8	927	116	250	114x114	90223L1100▲0◆00

LIGHT+ - Difusor opalino

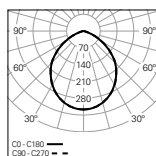

W	lm output	lm/W	mA	Size	CÓDIGO*
7	826	118	200	114x114	90272L1060▲0◆00
8	1023	128	250	114x114	90272L1100▲0◆00



*Sustituya los símbolos para completar el código

Color ▲
 Blanco W
 Negro B

Temp. de Color ◆
 3000K 3
 4000K 0

HOLI Sq /T

• Para completar el producto es necesario añadir fuente de alimentación y premarco. Por favor solicítelo por separado.

02. Seleccionar opciones

OPCIONES Código

Fuente de alimentación HF
 Driver 8,4W 10-42V 200mA HF 900001E
 Driver 10,5W 10-42V 250mA HF 900002E

Fuente de alimentación DALI
 Driver 10,4W 09-52V 200mA DALI+ PUSH 900101H
 Driver 13W 09-52V 250mA DALI+ PUSH 900102H

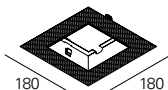
Premarco
 Blanco  971501

Cable de seguridad en acero
 L1500 mm 955000



Detalles del producto



Acabado blanco

Acabado negro

HOLI Sq /T Max



Características del productos

Cuerpo

Chapa de acero



Acabado

Pintado en epoxi-poliéster

230V/50Hz

Sistema de fijación

Premarco trimless



Sistema óptico

PRISM+ - Difusor microprismático
LIGHT+ - Difusor opalino

Fuente de luz

LED, RG1, CRI>80, MacAdam Step ≤3



Vida útil del LED

60.000h @ L70, B10, Ta 25°C

Fuente de alimentación

No incluida

01. Seleccionar versión

HOLI Sq /T Max

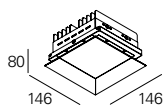

PRISM+ - Difusor microprismático

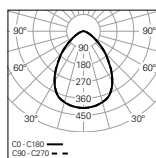

W	lm output	lm/W	mA	Φ	CÓDIGO*
8	1010	126	250	155x155	90224L1100▲0◆00
12	1363	114	350	155x155	90224L1130▲0◆00
18	1900	106	500	155x155	90224L1170▲0◆00

LIGHT+ - Difusor opalino

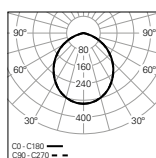

W	lm output	lm/W	mA	Φ	CÓDIGO*
8	1120	140	250	155x155	90287L1100▲0◆00
12	1533	128	350	155x155	90287L1130▲0◆00
18	2082	116	500	155x155	90287L1170▲0◆00



*Sustituya los símbolos para completar el código

Color ▲
 Blanco W
 Negro B

Temp. de Color ◆
 3000K 3
 4000K 0

HOLI Sq /T Max

• Para completar el producto es necesario añadir driver LED. Por favor solicítelo por separado.

02. Seleccionar opciones

OPCIONES Código

Fuente de alimentación HF	
Driver 10,5W 10-42V 250mA HF	900002E
Driver 14,7W 10-42V 350mA HF	900004E
Driver 21W 10-42V 500mA HF	900007E

Fuente de alimentación DALI	
Driver 13W 09-52V 250mA DALI+ PUSH	900102H
Driver 18,2W 09-52V 350mA DALI+ PUSH	900104H
Driver 26W 09-52V 500mA DALI+ PUSH	900107H

Premarco	
Blanco	971502

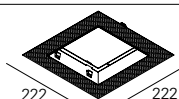

Cable de seguridad en acero	
L1500 mm	955000



Detalles del producto



Acabado blanco



Acabado negro





HOLI Sq Mini



Características del producto

Cuerpo

Chapa de acero

Acabado

Pintado en epoxi-poliéster

Sistema óptico

PRISM+ - Difusor microprismático
LIGHT+ - Difusor opalino

Fuente de luz

LED, RG1, CRI>80, MacAdam Step ≤3

Vida útil del LED

60.000h @ L70, B10, Ta 25°C

Fuente de alimentación

No incluida

Espesor del techo

Para techos entre 1-20 mm



230V/50Hz



IP 40

650°C



01. Seleccionar versión

HOLI Sq Mini

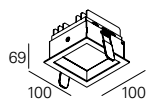

PRISM+ - Difusor microprismático

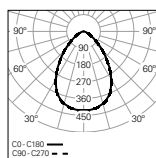

W	lm output	lm/W	mA	Size	CÓDIGO*
7	759	115	200	97x97	90258L1070▲0◆▲0

LIGHT+ - Difusor opalino

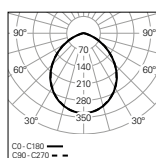

W	lm output	lm/W	mA	Size	CÓDIGO*
7	837	120	200	97x97	90293L1070▲0◆▲0



*Sustituya los símbolos para completar el código

Color	Symbol
Blanco	W/W
Negro	B/B
Blanco/Negro	W/B



Leyenda:
1. Marco
2. Reflector

Temp. de Color	Symbol
3000K	3
4000K	0

HOLI Sq Mini

• Para completar el producto es necesario añadir driver LED. Por favor solicítelo por separado.

02. Seleccionar opciones

OPCIONES	Código
Fuente de alimentación HF Driver 8,4W 10-42V 200mA HF	900001E
Fuente de alimentación DALI Driver 10,4W 09-52V 200mA DALI+ PUSH	900101H
Cable de seguridad en acero L1500 mm	955000



Detalles del producto



Acabado blanco

Acabado negro



Acabado blanco/ negro

HOLI Sq



Características del producto

Cuerpo

Chapa de acero

**Acabado**

Pintado en epoxi-poliéster

230V/50Hz

Sistema óptico

PRISM+ - Difusor microprismático
LIGHT+ - Difusor opalino

**Fuente de luz**

LED, RG1, CRI>80, MacAdam Step ≤3

Vida útil del LED

60.000h @ L70, B10, Ta 25°C

**Fuente de alimentación**

No incluida

Espesor del techo

Para techos entre 1-20 mm

01. Seleccionar versión

HOLI Sq

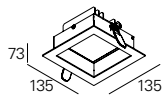

PRISM+ - Difusor microprismático

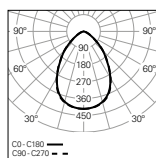

W	lm output	lm/W	mA	□	CÓDIGO*
7	748	107	200	115x115	90259L1060♣0♣♣0
8	927	116	250	115x115	90259L1100♣0♣♣0

LIGHT+ - Difusor opalino

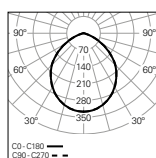

W	lm output	lm/W	mA	□	CÓDIGO*
7	826	118	200	115x115	90294L1060♣0♣♣0
8	1023	128	250	115x115	90294L1100♣0♣♣0



*Sustituya los símbolos para completar el código

Color	♣/♣
□ Blanco	W/W
■ Negro	B/B
▣ Blanco/Negro	W/B



Leyenda:

1. Marco
2. Reflector

Temp. de Color	♣
3000K	3
4000K	0

HOLI Sq

• Para completar el producto es necesario añadir driver LED. Por favor solicítelo por separado.

02. Seleccionar opciones

OPCIONES	Código
Fuente de alimentación HF	
Driver 8,4W 10-42V 200mA HF	900001E
Driver 10,5W 10-42V 250mA HF	900002E
Fuente de alimentación DALI	
Driver 10,4W 09-52V 200mA DALI+ PUSH	900101H
Driver 13W 09-52V 250mA DALI+ PUSH	900102H
Cable de seguridad en acero	
L1500 mm	955000



Detalles del producto



Acabado blanco



Acabado negro



Acabado blanco/ negro

HOLI Sq Max



Características del producto

Cuerpo

Chapa de acero

Acabado

Pintado en epoxi-poliéster

Sistema óptico

PRISM+ - Difusor microprismático
LIGHT+ - Difusor opalino

Fuente de luz

LED, RG1, CRI>80, MacAdam Step ≤3

Vida útil del LED

60.000h @ L70, B10, Ta 25°C

Fuente de alimentación

No incluida

Espesor del techo

Para techos entre 1-20 mm



230V/50Hz



IP 40

650°C



01. Seleccionar versión

HOLI Sq Max

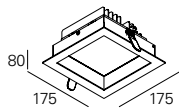

PRISM+ - Difusor microprismático

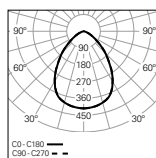

W	lm output	lm/W	mA	Φ	CÓDIGO*
8	1010	126	250	155x155	90264L1100♣♣♣0
12	1363	114	350	155x155	90264L1130♣♣♣0
18	1900	106	500	155x155	90264L1170♣♣♣0

LIGHT+ - Difusor opalino

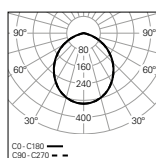

W	lm output	lm/W	mA	Φ	CÓDIGO*
8	1120	140	250	155x155	90295L1100♣♣♣0
12	1533	128	350	155x155	90295L1130♣♣♣0
18	2082	116	500	155x155	90295L1170♣♣♣0



*Sustituya los símbolos para completar el código

Color	♣/♠
□ Blanco	W/W
■ Negro	B/B
▣ Blanco/ Negro	W/B



Leyenda:

1. Marco
2. Reflector

Temp. de Color	♠
3000K	3
4000K	0

HOLI Sq Max

• Para completar el producto es necesario añadir driver LED. Por favor solicítelo por separado.

02. Seleccionar opciones

OPCIONES

	Código
Fuente de alimentación HF	
Driver 10,5W 10-42V 250mA HF	900002E
Driver 14,7W 10-42V 350mA HF	900004E
Driver 21W 10-42V 500mA HF	900007E
Fuente de alimentación DALI	
Driver 13W 09-52V 250mA DALI+ PUSH	900102H
Driver 18,2W 09-52V 350mA DALI+ PUSH	900104H
Driver 26W 09-52V 500mA DALI+ PUSH	900107H
Cable de seguridad en acero	
L1500 mm	955000



Detalles del producto



Acabado blanco

Acabado negro



Acabado blanco/ negro





HOLI Sq /AS Max



Características del producto

Cuerpo

Chapa de acero



Acabado

Pintado en epoxi-poliéster

230V/50Hz

Sistema óptico

LIGHT+ - Difusor opalino



Fuente de luz

LED, RG1, CRI>80, MacAdam Step ≤3

Vida útil del LED

60.000h @ L70, B10, Ta 25°C



Fuente de alimentación

No incluida

Espesor del techo

Para techos entre 1-20 mm

01. Seleccionar versión

HOLI Sq /AS Max

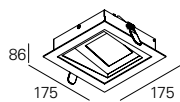

LIGHT+ - Difusor opalino

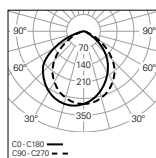

W	lm output	lm/W	mA	□	CÓDIGO*
7	792	113	200	155x155	90393L1060♣0♣♣0
12	1344	112	350	155x155	90393L1100♣0♣♣0



*Sustituya los símbolos para completar el código

Color	♣/♣
□ Blanco	W/W
■ Negro	B/B
▣ Blanco/Negro	W/B



Leyenda:

1. Marco
2. Reflector

HOLI Sq /AS Max

• Para completar el producto es necesario añadir driver LED. Por favor solicítelo por separado.

Temp. de Color	♠
3000K	3
4000K	0

02. Seleccionar opciones

OPCIONES Código

Fuente de alimentación HF	Código
Driver 8,4W 10-42V 200mA HF	900001E
Driver 14,7W 10-42V 350mA HF	900004E

Fuente de alimentación DALI	Código
Driver 10,4W 09-52V 200mA DALI+ PUSH	900101H
Driver 18,2W 09-52V 350mA DALI+ PUSH	900104H

Cable de seguridad en acero	Código
L1500 mm	955000



Detalles del producto



Acabado blanco



Acabado negro



Acabado blanco/ negro

HOLI Sq /C Mini



Características del producto

Cuerpo

Chapa de acero



Acabado

Pintado en epoxi-poliéster

230V/50Hz

Sistema óptico

LIGHT+ - Difusor opalino



Fuente de luz

LED, RG1, CRI>80, MacAdam Step ≤ 3

Vida útil del LED

60.000h @ L70, B10, Ta 25°C



Fuente de alimentación

Driver LED 220-240V-50/60Hz incluido

01. Seleccionar versión

HOLI Sq /C Mini

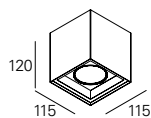

LIGHT+ - Difusor opalino

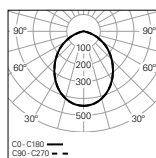

W
8

lm output
930

lm/W
116

CÓDIGO*
90269L006▼▲0◆▲0



*Sustituya los símbolos para completar el código

Fuente de alimentación ▼
HF E
DALI H

Color ▲/▲
□ Blanco W/W
■ Negro B/B
▣ Blanco/Negro W/B

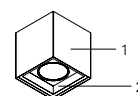

Leyenda:
1. Cuerpo
2. Reflector

Temp. de Color ◆
3000K 3
4000K 0

HOLI Sq /C



Características del producto

Cuerpo

Chapa de acero

Acabado

Pintado en epoxi-poliéster

Sistema óptico

LIGHT+ - Difusor opalino

Fuente de luz

LED, RG1, CRI>80, MacAdam Step ≤ 3

Vida útil del LED

60.000h @ L70, B10, Ta 25°C

Fuente de alimentación

Driver LED 220-240V-50/60Hz incluido



230V/50Hz



IP 40

650°C

01. Seleccionar versión

HOLI Sq /C

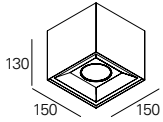

LIGHT+ - Difusor opalino

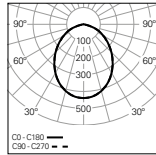

W
8
14

lm output
930
1576

lm/W
116
113

CÓDIGO*
90270L006♥♣0♦♣0
90270L110♥♣0♦♣0



*Sustituya los símbolos para completar el código

Fuente de alimentación ▼
HF E
DALI H

Color ♣/♠
□ Blanco W/W
■ Negro B/B
▣ Blanco/Negro W/B

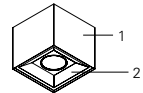

Leyenda:
1. Cuerpo
2. Reflector

Temp. de Color ♦
3000K 3
4000K 0

HOLI Sq /C Max



Características del productos

Cuerpo

Chapa de acero



Acabado

Pintado en epoxi-poliéster

230V/50Hz

Sistema óptico

LIGHT+ - Difusor opalino

Fuente de luz

LED, RG1, CRI>80, MacAdam Step ≤ 3



IP 40

Vida útil del LED

60.000h @ L70, B10, Ta 25°C

650°C

Fuente de alimentación

Driver LED 220-240V-50/60Hz incluido

01. Seleccionar versión

HOLI Sq /C Max

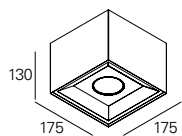

LIGHT+ - Difusor opalino

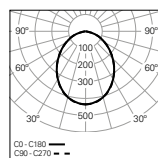

W
14
21
22

lm output
1576
2166
2492

lm/W
113
103
113

CÓDIGO*

90291L110	♥♣0♦♣0
90291L113	♥♣0♦♣0
90291L117	♥♣0♦♣0



*Sustituya los símbolos para completar el código

Fuente de alimentación	▼
HF	E
DALI	H

Color	♣/♠
□ Blanco	W/W
■ Negro	B/B
▣ Blanco/Preto	W/B

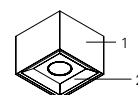

Leyenda:
1. Cuerpo
2. Reflector

Temp. de Color	♦
3000K	3
4000K	0







107

SENSE



SENSE
416



SENSE



Características del productos

Cuerpo

Aluminio

**Acabado**

Pintado en epoxi-poliéster

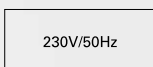
**Sistema óptico**

DOZ - Difusor em policarbonato opalino

**Cableado**

Cable H05-FVV de L1000 mm

**Fuente de luz**

LED, RG1, CRI>80, MacAdam Step ≤3

Vida útil del LED

50.000h @ L80, B10, Ta 25°C

Fuente de alimentación

No incluida

Espesor del techo

Para techos entre 1-25 mm

01. Seleccionar versión

SENSE



DOZ - Difusor em policarbonato opalino

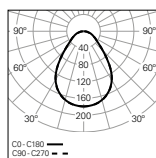

W	lm output	mA	Ø
1	50	350	Ø46
3	84	700	Ø46

CÓDIGO*

90062L101E♣0♦00
90062L103E♣0♦00

*Sustituya los símbolos para completar el código

Color ♣
 Blanco W
 Negro B

Temp. de Color ♦
 3000K 3
 4000K 0

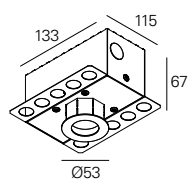

DOZ - Difusor em policarbonato opalino + Caixa de Empotrar

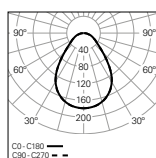

W	lm output	mA	Ø
1	50	350	135x65
3	84	700	135x65

CÓDIGO*

90854L101E♣0♦00
90854L103E♣0♦00

SENSE

- Para completar el producto es necesario añadir driver LED. Por favor solicítelo por separado.

02. Seleccionar opciones

OPCIONES

Código

Fuente de alimentación HF

Driver LED 350mA	965704
Driver LED 700mA	965705

Versión IP20/65

- Mediante solicitud.



FESAL



FESAL
420



FESAL Sq
422

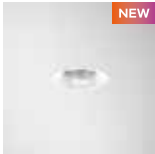

FESAL IP
424

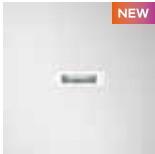

FESAL Sq IP
426



FESAL



Características del productos

Cuerpo

Aluminio

**Acabado**

Pintado en epoxi-poliéster

**Sistema óptico**

PB - Reflector brillante

**Fuente de luz**

LED, RG1, CRI>90, MacAdam Step ≤3

Vida útil del LED

50.000h @ L80, B10, Ta 25°C

Fuente de alimentación

No incluida

Espesor del techo

Para techos entre 1-25 mm

01. Seleccionar versión

FESAL

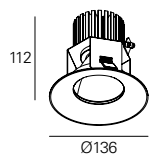

PB - Reflector brillante | Ángulo de apertura 35°

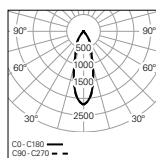

UGR	W	lm output	lm/W	mA	Ø	CÓDIGO*
≤13	7	932	143	200	Ø132	90019L00L0▲0◆35
≤16	12	1578	134	350	Ø132	90019L00H0▲0◆35

PB - Reflector brillante | Ángulo de apertura 60°

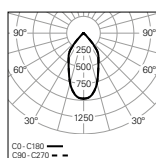

UGR	W	lm output	lm/W	mA	Ø	CÓDIGO*
≤19	7	953	146	200	Ø132	90019L00L0▲0◆60
≤19	12	1596	136	350	Ø132	90019L00H0▲0◆60



*Sustituya los símbolos para completar el código

Color ▲
 Blanco W
 Negro B

Temp. de Color ◆
 3000K B
 4000K A

FESAL

• Para completar el producto es necesario añadir driver LED. Por favor solicítelo por separado.

02. Seleccionar opciones

OPCIONES	Código
----------	--------

Fuente de alimentación HF	
Driver 8,4W 10-42V 200mA HF	900001E
Driver 14,7W 10-42V 350mA HF	900004E

Fuente de alimentación DALI	
Driver 10,4W 09-52V 200mA DALI+ PUSH	900101H
Driver 18,2W 09-52V 350mA DALI+ PUSH	900104H

Cable de seguridad en acero	
L1500 mm	955000

FESAL Sq



Características del productos

Cuerpo

Chapa de acero

**Acabado**

Pintado en epoxi-poliéster

**Sistema óptico**

PB - Reflector brillante

**Fuente de luz**

LED, RG1, CRI>90, MacAdam Step ≤3

Vida útil del LED

50.000h @ L80, B10, Ta 25°C

Fuente de alimentación

No incluida

Espesor del techo

Para techos entre 1-25 mm

01. Seleccionar versión

FESAL Sq

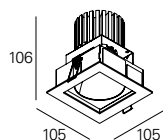

PB - Reflector brillante | Ángulo de apertura 35°

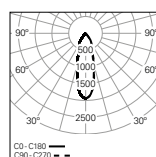

UGR	W	lm output	lm/W	mA	Beam	CÓDIGO*
≤16	8	796	122	200	95x93	90767L00L0♣0♦35
≤19	14	1330	113	350	95x93	90767L00H0♣0♦35

PB - Reflector brillante | Ángulo de apertura 60°

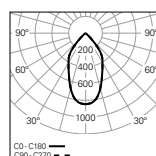

UGR	W	lm output	lm/W	mA	Beam	CÓDIGO*
≤22	8	817	125	200	95x93	90767L00L0♣0♦60
≤22	14	1347	115	350	95x93	90767L00H0♣0♦60



*Sustituya los símbolos para completar el código

Color ♣
 Blanco W
 Negro B

Temp. de Color ♦
 3000K B
 4000K A

FESAL Sq

• Para completar el producto es necesario añadir driver LED. Por favor solicítelo por separado.

02. Seleccionar opciones

OPCIONES Código

Fuente de alimentación HF	
Driver 8,4W 10-42V 200mA HF	900001E
Driver 14,7W 10-42V 350mA HF	900004E

Fuente de alimentación DALI	
Driver 10,4W 09-52V 200mA DALI+ PUSH	900101H
Driver 18,2W 09-52V 350mA DALI+ PUSH	900104H

Cable de seguridad en acero	
L1500 mm	955000

FESAL IP



Características del productos

Cuerpo

Aluminio

Acabado

Pintado en epoxi-poliéster

Sistema óptico

PB - Reflector brillante
Policarbonato transparente

Fuente de luz

LED, RG1, CRI>90, MacAdam Step ≤ 3

Vida útil del LED

50.000h @ L80, B10, Ta 25°C

Fuente de alimentación

No incluida

Espesor del techo

Para techos entre 1-25 mm



01. Seleccionar versión



FESAL IP

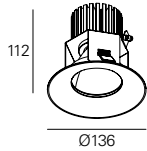

PB - Reflector brillante | Ángulo de apertura 35°

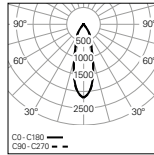

W	lm output	lm/W	mA	Ø
8	932	143	200	Ø132
14	1578	134	350	Ø132

CÓDIGO*

90765L00L0♣0♦35
90765L00H0♣0♦35

*Sustituya los símbolos para completar el código

Color ♣
□ Blanco W
■ Negro B

Temp. de Color ♦
3000K B
4000K A

PB - Reflector brillante | Ángulo de apertura 60°

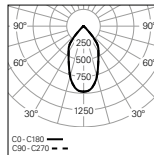

W	lm output	lm/W	mA	Ø
8	953	146	200	Ø132
14	1596	136	350	Ø132

CÓDIGO*

90765L00L0♣0♦60
90765L00H0♣0♦60

FESAL IP

• Para completar el producto es necesario añadir driver LED. Por favor solicítelo por separado.

02. Seleccionar opciones

OPCIONES Código

Fuente de alimentación HF	
Driver 8,4W 10-42V 200mA HF	900001E
Driver 14,7W 10-42V 350mA HF	900004E

Fuente de alimentación DALI	
Driver 10,4W 09-52V 200mA DALI+ PUSH	900101H
Driver 18,2W 09-52V 350mA DALI+ PUSH	900104H

Cable de seguridad en acero	
L1500 mm	955000

FESAL Sq IP



Características del productos

Cuerpo

Chapa de acero

Acabado

Pintado en epoxi-poliéster

Sistema óptico

PB - Reflector brillante
Policarbonato transparente

Fuente de luz

LED, RG1, CRI>90, MacAdam Step ≤ 3

Vida útil del LED

50.000h @ L80, B10, Ta 25°C

Fuente de alimentación

No incluida

Espesor del techo

Para techos entre 1-25 mm



01. Seleccionar versión

FESAL Sq IP

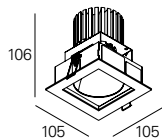

PB - Reflector brillante | Ángulo de apertura 35°

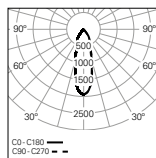

W	Im output	lm/W	mA	Size	CÓDIGO*
8	796	122	200	95x93	90766L00L0♣0♦35
14	1330	113	350	95x93	90766L00H0♣0♦35

PB - Reflector brillante | Ángulo de apertura 60°

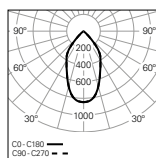

W	Im output	lm/W	mA	Size	CÓDIGO*
8	817	125	200	95x93	90766L00L0♣0♦60
14	1347	115	350	95x93	90766L00H0♣0♦60



*Sustituya los símbolos para completar el código

Color ♣
 Blanco W
 Negro B

Temp. de Color ♦
 3000K B
 4000K A

FESAL Sq IP

• Para completar el producto es necesario añadir driver LED. Por favor solicítelo por separado.

02. Seleccionar opciones

OPCIONES Código

Fuente de alimentación HF

Driver 8,4W 10-42V 200mA HF	900001E
Driver 14,7W 10-42V 350mA HF	900004E

Fuente de alimentación DALI

Driver 10,4W 09-52V 200mA DALI+ PUSH	900101H
Driver 18,2W 09-52V 350mA DALI+ PUSH	900104H

Cable de seguridad en acero

L1500 mm	955000
----------	--------



DYNA



DYNA MINI
430

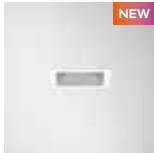

DYNA MINI Sq
432



DYNA MINI /C
434



DYNA
438

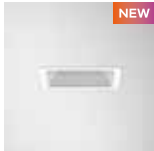

DYNA Sq
440



DYNA /C
442



DYNA IP
444

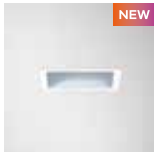

DYNA Sq IP
446



DYNA MINI



Características del productos

Cuerpo

Aluminio

**Acabado**

Pintado en epoxi-poliéster

**Sistema óptico**

PM - Reflector mate

Fuente de luz

LED, RG1, CRI>90, MacAdam Step ≤3

**Vida útil del LED**

50.000h @ L80, B10, Ta 25°C

Fuente de alimentación

No incluida

Espesor del techo

Para techos entre 1-20 mm

01. Seleccionar versión

DYNA MINI

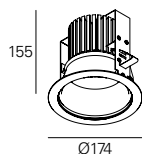

PM - Reflector mate

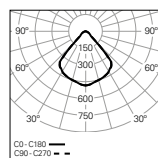

W	lm output	lm/W	mA	Ø	CÓDIGO*
8	1064	129	250	Ø155	90183L00L0♣0♦00
17	2125	128	500	Ø155	90183L00M0♣0♦00
24	2881	120	700	Ø155	90183L00H0♣0♦00



*Sustituya los símbolos para completar el código

Color ♣
 Blanco W
 Negro B

Temp. de Color ♦
 3000K B
 4000K A

DYNA MINI

• Para completar el producto es necesario añadir driver LED. Por favor solicítelo por separado.

02. Seleccionar opciones

OPCIONES Código

Fuente de alimentación HF

Driver 10,5W 10-42V 250mA HF	900002E
Driver 21W 10-42V 500mA HF	900007E
Driver 28W 28-40V 700mA HF	900303E

Fuente de alimentación DALI

Driver 13W 09-52V 250mA DALI+ PUSH	900102H
Driver 26W 09-52V 500mA DALI+ PUSH	900107H
Driver 26,3W 09-37,5V 700mA DALI+ PUSH	900111H

Cable de seguridad en acero

L1500 mm	955000
----------	--------



Detalles del producto



Downlight



Vista frontal

DYNA MINI Sq



Características del productos

Cuerpo

Chapa de acero

**Acabado**

Pintado en epoxi-poliéster

**Sistema óptico**

PM - Reflector mate

Fuente de luz

LED, RG1, CRI>90, MacAdam Step ≤3

**Vida útil del LED**

50.000h @ L80, B10, Ta 25°C

Fuente de alimentación

No incluida

Espesor del techo

Para techos entre 1-25 mm

01. Seleccionar versión

DYNA MINI Sq

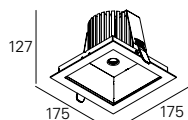

PM - Reflector mate

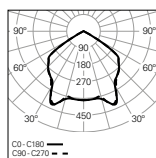

W	lm output	lm/W	mA	□	CÓDIGO*
8	1297	157	250	165x160	90760L00L0♣0♦00
17	2505	150	500	165x160	90760L00M0♣0♦00
24	3396	142	700	165x160	90760L00H0♣0♦00



*Sustituya los símbolos para completar el código

Color	♣
□ Blanco	W
■ Negro	B

Temp. de Color	♦
3000K	B
4000K	A

DYNA MINI Sq

• Para completar el producto es necesario añadir driver LED. Por favor solicítelo por separado.

02. Seleccionar opciones

OPCIONES Código

Fuente de alimentación HF	
Driver 10,5W 10-42V 250mA HF	900002E
Driver 21W 10-42V 500mA HF	900007E
Driver 28W 28-40V 700mA HF	900303E

Fuente de alimentación DALI	
Driver 13W 09-52V 250mA DALI+ PUSH	900102H
Driver 26W 09-52V 500mA DALI+ PUSH	900107H
Driver 26,3W 09-37,5V 700mA DALI+ PUSH	900111H

Cable de seguridad en acero	
L1500 mm	955000



Detalles del producto



Downlight



Vista frontal

DYNA MINI /C



Características del productos

Cuerpo

Aluminio

**Acabado**

Pintado en epoxi-poliéster

230V/50Hz

Sistema óptico

PM - Reflector mate



IP 20

Fuente de luz

LED, RG1, CRI>90, MacAdam Step ≤3

Vida útil del LED

50.000h @ L80, B10, Ta 25°C

650°C

Fuente de alimentación

Driver LED 220-240V-50/60Hz incluido

01. Seleccionar versión



DYNA MINI /C

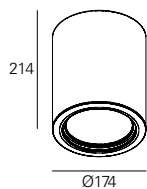

PM - Reflector mate

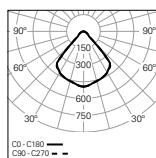

W
9
14
21

lm output
1064
1454
2125

lm/W
118
104
101

CÓDIGO*

90761L00L	♥♣0♦00
90761L00M	♥♣0♦00
90761L00H	♥♣0♦00

*Sustituya los símbolos para completar el código

Fuente de alimentación	▼
HF	E
DALI	H

Color	♣
□ Blanco	W
■ Negro	B

Temp. de Color	♦
3000K	B
4000K	A

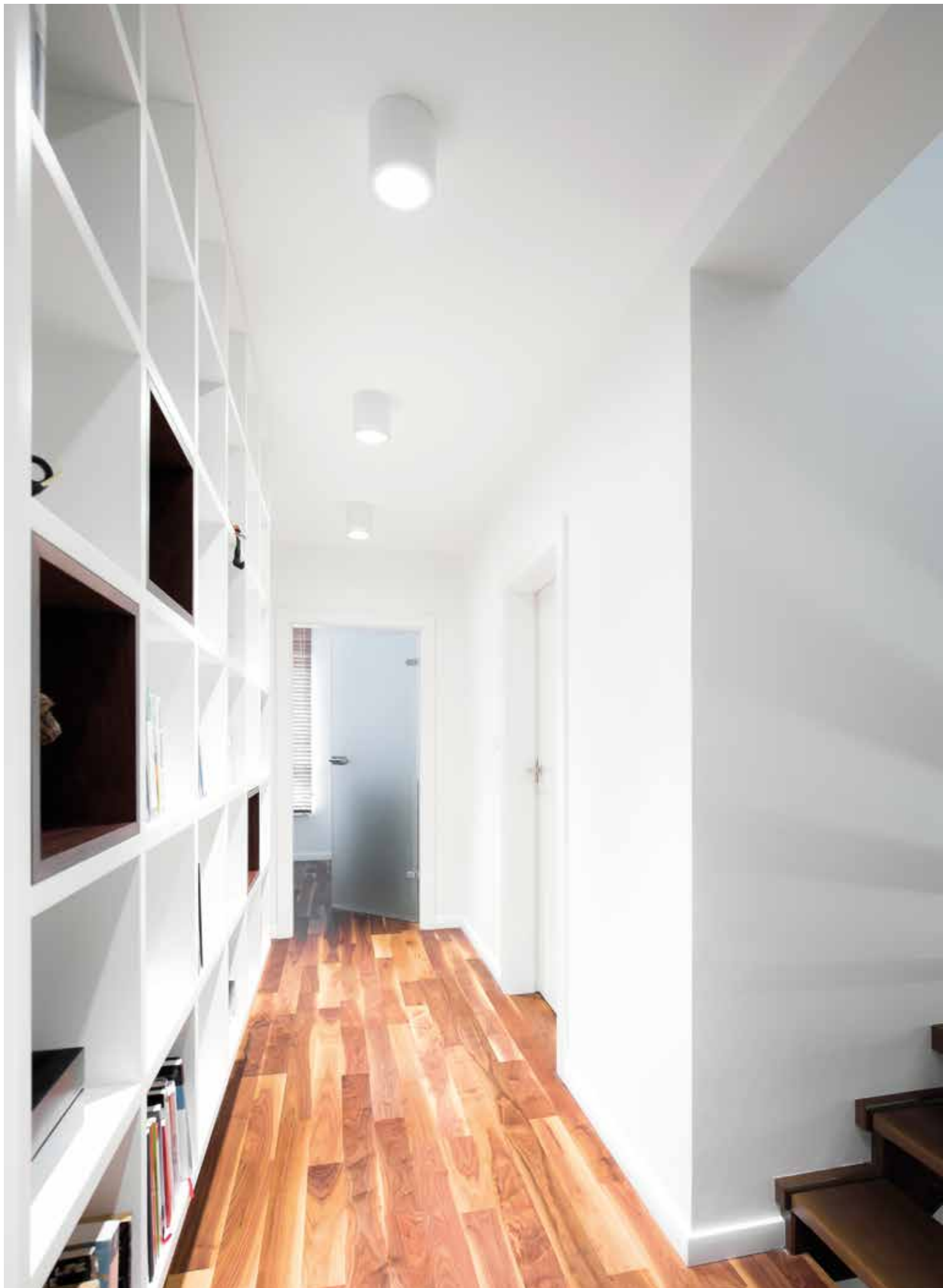



DYNA



Características del productos

Cuerpo

Aluminio



Acabado

Pintado en epoxi-poliéster



Sistema óptico

EFFICIENT - Reflector mate de alto rendimiento

CONTROL - Reflector mate para control del deslumbramiento



Fuente de luz

LED, RG1, CRI>80, MacAdam Step ≤3

Vida útil del LED

60.000h @ L70, B10, Ta 25°C

Fuente de alimentación

No incluida

Espesor del techo

Para techos entre 1-25 mm

01. Seleccionar versión

DYNA

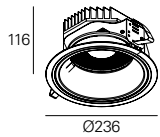

EFFICIENT - Reflector mate de alto rendimiento | Ángulo de 80°

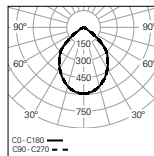

UGR	W	lm output	lm/W	mA	Ø	CÓDIGO*
≤19	8	1172	145	250	Ø220	90014L00L0♣0♦00
≤19	17	2283	135	500	Ø220	90014L00M0♣0♦00
≤22	24	3096	128	700	Ø220	90014L00H0♣0♦00

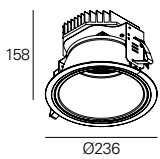

CONTROL - Reflector mate para control del deslumbramiento | Ángulo de 80°

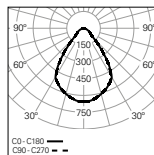

UGR	W	lm output	lm/W	mA	Ø	CÓDIGO*
≤16	8	1125	139	250	Ø220	90123L00L0♣0♦00
≤19	17	2168	128	500	Ø220	90123L00M0♣0♦00
≤19	24	3002	124	700	Ø220	90123L00H0♣0♦00



*Sustituya los símbolos para completar el código

Color ♣
 Blanco W
 Negro B

Temp. de Color ♦
 3000K 3
 4000K 0

DYNA

• Para completar el producto es necesario añadir driver LED. Por favor solicítelo por separado.

02. Seleccionar opciones

OPCIONES Código

Fuente de alimentación HF	
Driver 10,5W 10-42V 250mA HF	900002E
Driver 21W 10-42V 500MA HF	900007E
Driver 28W 28-40V 700MA HF	900303E

Fuente de alimentación DALI	
Driver 13W 09-52V 250mA DALI+ PUSH	900102H
Driver 26W 09-52V 500MA DALI+ PUSH	900107H
Driver 26,3W 09-37,5V 700mA DALI+ PUSH	900111H

Cable de seguridad en acero	
L1500 mm	955000

Kit de emergencia (3 Horas)

• Mediante solicitud.



Detalles del producto



Disipador pasivo



Vista frontal

DYNA Sq



Características del productos

Cuerpo

Chapa de acero



Acabado

Pintado en epoxi-poliéster



Sistema óptico

PM - Reflector mate

Fuente de luz

LED, RG1, CRI>80, MacAdam Step ≤3



Vida útil del LED

60.000h @ L70, B10, Ta 25°C

Fuente de alimentación

No incluida

Espesor del techo

Para techos entre 1-25 mm

01. Seleccionar versión



DYNA Sq

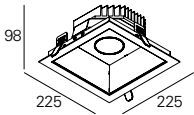

PM - Reflector mate

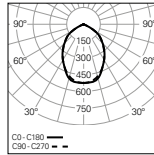

W	lm output	lm/W	mA	Φ	CÓDIGO*
8	1172	145	250	209x209	90757L00L0♣0♦00
17	2283	135	500	209x209	90757L00M0♣0♦00
24	3096	128	700	209x209	90757L00H0♣0♦00

*Sustituya los símbolos para completar el código

Color	↕
□ Blanco	W
■ Negro	B

Temp. de Color	↕
3000K	3
4000K	0

DYNA Sq

• Para completar el producto es necesario añadir driver LED. Por favor solicítelo por separado.

02. Seleccionar opciones



Detalles del producto

OPCIONES Código

Fuente de alimentación HF	
Driver 10,5W 10-42V 250mA HF	900002E
Driver 21W 10-42V 500MA HF	900007E
Driver 28W 28-40V 700MA HF	900303E

Fuente de alimentación DALI	
Driver 13W 09-52V 250mA DALI+ PUSH	900102H
Driver 26W 09-52V 500MA DALI+ PUSH	900107H
Driver 26,3W 09-37,5V 700mA DALI+ PUSH	900111H

Cable de seguridad en acero	
L1500 mm	955000

Kit de emergencia (3 Horas)

• Mediante solicitud.



Vista frontal

DYNA /C



Características del productos

Cuerpo

Aluminio

**Acabado**

Pintado en epoxi-poliéster

230V/50Hz

Sistema óptico

PM - Reflector mate



IP 20

Fuente de luz

LED, RG1, CRI>80, MacAdam Step ≤ 3

Vida útil del LED

60.000h @ L70, B10, Ta 25°C

650°C

Fuente de alimentación

Driver LED 220-240V-50/60Hz incluido

01. Seleccionar versión



DYNA / C

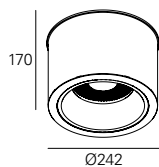

PM - Reflector mate

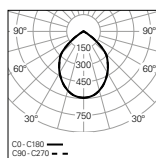

W
9
19
28

lm output
1172
2283
3096

lm/W
130
120
111

CÓDIGO*

90759L00L♥♣0♦00
90759L00M♥♣0♦00
90759L00H♥♣0♦00

*Sustituya los símbolos para completar el código

Fuente de alimentación ▼
HF E
DALI H

Color ♣
□ Blanco W
■ Negro B

Temp. de Color ♦
3000K 3
4000K 0

DYNA IP



Características del productos

Cuerpo

Aluminio

**Acabado**

Pintado en epoxi-poliéster

**Sistema óptico**

Vidrio templado opal

**Fuente de luz**

LED, RG1, CRI>80, MacAdam Step ≤3

Vida útil del LED

60.000h @ L70, B10, Ta 25°C

**Fuente de alimentación**

No incluida

Espesor del techo

Para techos entre 1-20 mm

01. Seleccionar versión

DYNA IP

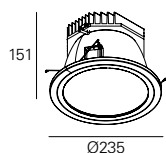

Vidrio templado opal

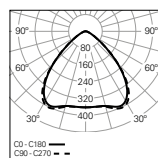

W	lm output	lm/W	mA	Ø	CÓDIGO*
17	2326	138	500	Ø215	90136L00L0♣0♦00
24	3121	129	700	Ø215	90136L00M0♣0♦00
32	3884	121	900	Ø215	90136L00H0♣0♦00



*Sustituya los símbolos para completar el código

Color 
 Blanco W
 Negro B

Temp. de Color 
 3000K 3
 4000K 0

DYNA IP

• Para completar el producto es necesario añadir driver LED. Por favor solicítelo por separado.

02. Seleccionar opciones

OPCIONES Código

Fuente de alimentación HF

Driver 21W 10-42V 500mA HF	900007E
Driver 28W 28-40V 700mA HF	900303E
Driver 37,8W 30-42V 900mA HF	900500E

Fuente de alimentación DALI

Driver 26W 09-52V 500MA DALI+ PUSH	900107H
Driver 26,3W 09-37,5V 700mA DALI+ PUSH	900111H
Driver 44,1W 09-49V 900mA DALI+ PUSH	900604H

Cable de seguridad en acero

L1500 mm	955000
----------	--------

Kit de emergencia (3 Horas)

• Mediante solicitud.



Detalles del producto



Niveladores

DYNA Sq IP



Características del producto

Cuerpo

Chapa de acero



Acabado

Pintado en epoxi-poliéster



Sistema óptico

Vidrio templado opal



Fuente de luz

LED, RG1, CRI>80, MacAdam Step ≤3

Vida útil del LED

60.000h @ L70, B10, Ta 25°C



Fuente de alimentación

No incluida

Espesor del techo

Para techos entre 1-25 mm

01. Seleccionar versión

DYNA Sq IP

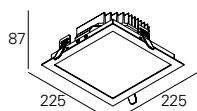

Vidrio templado opal

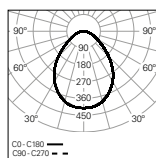

W	lm output	lm/W	mA	∅	CÓDIGO*
17	2326	138	500	209x209	90758L00L0♣0♦00
24	3121	129	700	209x209	90758L00M0♣0♦00
32	3884	121	900	209x209	90758L00H0♣0♦00



*Sustituya los símbolos para completar el código

Color

Blanco W

Negro B

Temp. de Color

3000K 3

4000K 0

DYNA Sq IP

• Para completar el producto es necesario añadir driver LED. Por favor solicítelo por separado.

02. Seleccionar opciones

OPCIONES Código

Fuente de alimentación HF	
Driver 21W 10-42V 500mA HF	900007E
Driver 28W 28-40V 700mA HF	900303E
Driver 37,8W 30-42V 900mA HF	900500E

Fuente de alimentación DALI	
Driver 26W 09-52V 500MA DALI+ PUSH	900107H
Driver 26,3W 09-37,5V 700mA DALI+ PUSH	900111H
Driver 44,1W 09-49V 900mA DALI+ PUSH	900604H

Cable de seguridad en acero	
L1500 mm	955000

Kit de emergencia (3 Horas)

• Mediante solicitud.



Detalles del producto



Vista frontal







Iluminación
arquitectónica

AURA



AURA
452



AURA

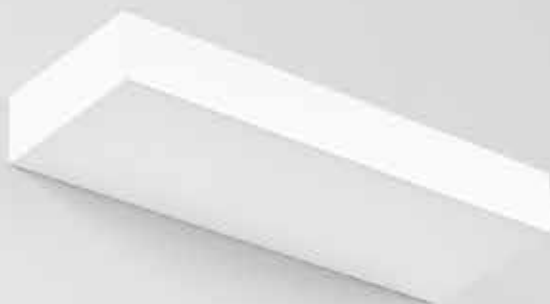

Características del productos

Cuerpo

Chapa de acero



Acabado

Pintado en epoxi-poliéster

230V/50Hz

Sistema óptico

LIGHT+ - Difusor opalino



IP 40

Fuente de luz

LED, RG1, CRI>80, MacAdam Step ≤3

Vida útil del LED

80.000h @ L80, B10, Ta 25°C

650°C

Fuente de alimentación

Driver LED 220-240V-50/60Hz incluido

01. Seleccionar versión



AURA

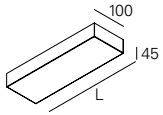

LIGHT+ - Difusor opalino

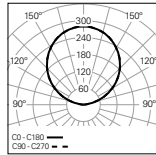

W	lm output	lm/W	Lmm	CÓDIGO*
16	2017	126	300	90825L030▼▲◆00
31	4034	130	600	90825L060▼▲◆00

*Sustituya los símbolos para completar el código

Fuente de alimentación	▼
HF	E
DALI	H

Color ¹	▲
□ Blanco	W
■ Negro	B

Temp. de Color	◆
3000K	3
4000K	0



Detalles del producto



Difusor

¹ Otros colores mediante solicitud.

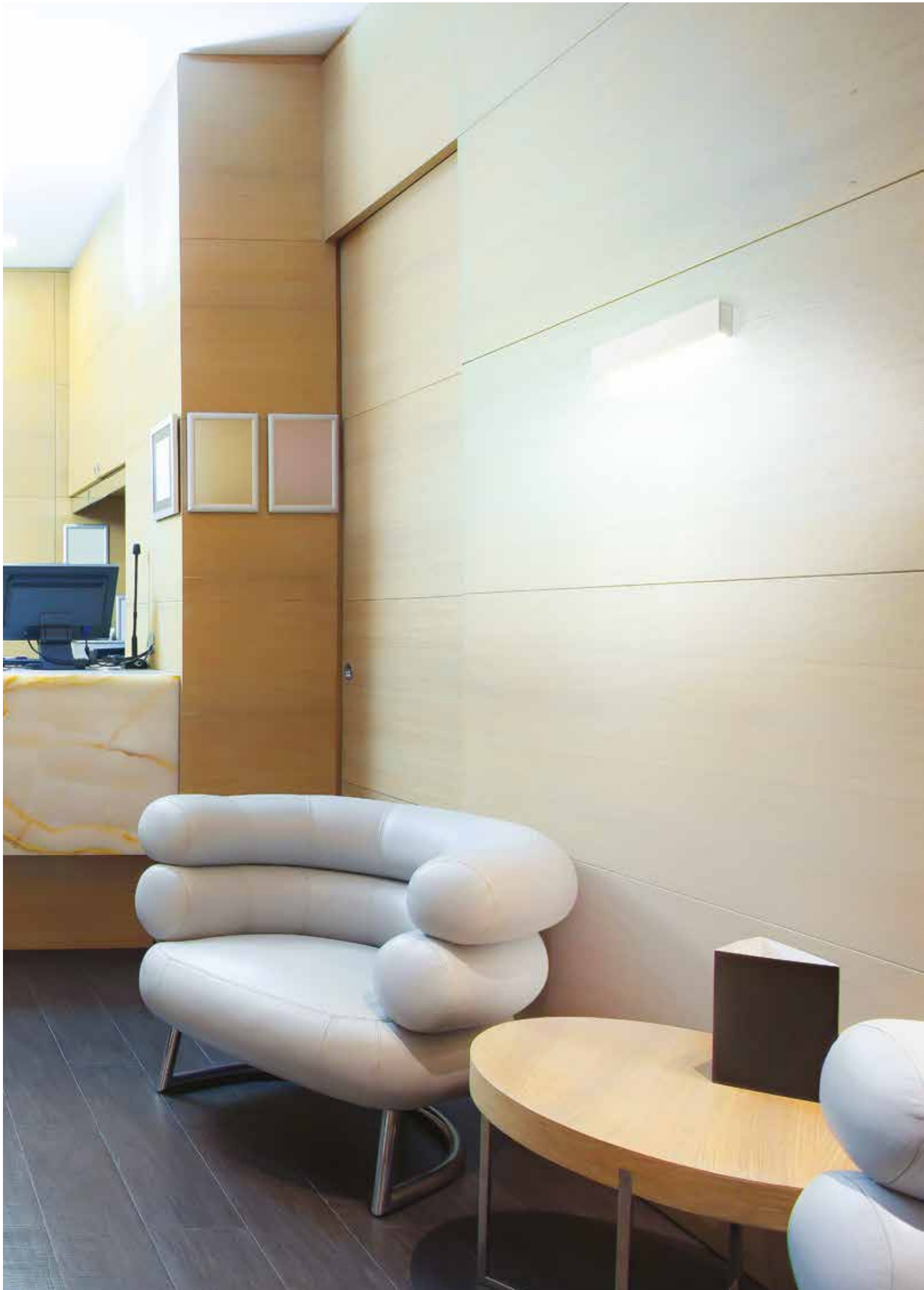

Iluminación
arquitectónica

SLIM



SLIM
456



SLIM



Características del productos

Cuerpo

Chapa de acero



Acabado

Pintado en epoxi-poliéster

230V/50Hz

Sistema óptico

LIGHT+ - Difusor opalino



Fuente de luz

LED, RG1, CRI>80, MacAdam Step ≤ 3

Vida útil del LED

80.000h @ L90, B10, Ta 25°C

650°C

Fuente de alimentación

Driver LED 220-240V-50/60Hz incluido

01. Seleccionar versión

SLIM

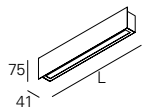

LIGHT+ - Difusor opalino

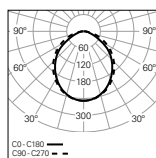

W	lm output	lm/W	Lmm	CÓDIGO*
8	802	100	350	90833L350▼▲0◆00
15	1603	107	590	90833L590▼▲0◆00



*Sustituya los símbolos para completar el código

Fuente de alimentación	▼
HF	E
DALI	H

Color ¹	▲
<input type="checkbox"/> Blanco	W
<input checked="" type="checkbox"/> Negro	B

Temp. de Color	◆
3000K	3
4000K	0



Detalles del producto



Proporción del producto

¹ Otros colores mediante solicitud.



Iluminación
arquitectónica

VISA



VISA
460



VISA

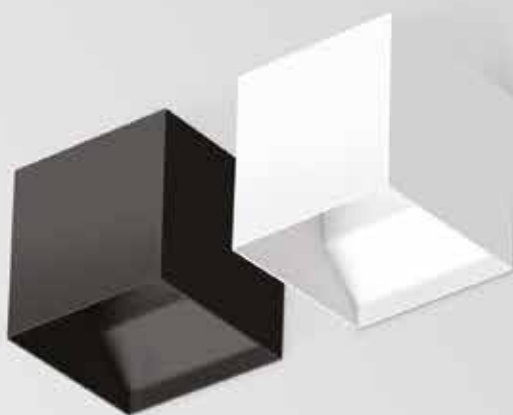

Características del productos

Cuerpo

Chapa de acero

Acabado

Pintado en epoxi-poliéster

Fuente de luz

LED, RG1, CRI>80, MacAdam Step ≤3

Vida útil del LED

50.000h @ L80, B10, Ta 25°C

Fuente de alimentación

Driver LED 220-240V-50/60Hz incluido



230V/50Hz



IP 20

650°C

01. Seleccionar versión



VISA

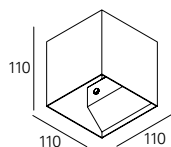

Direta / Indireta | Ángulo de apertura 90° + 90°

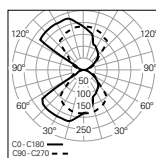

W
3
5

lm output
141
232

CÓDIGO*
90220L101E♣0♦90
90220L103E♣0♦90

***Sustituya los símbolos para completar el código**

Color		♣
□	Blanco	W
■	Negro	B
■	Sahara	0
■	Carbon	I
■	Rusty chain	R
■	Golden eye	D

Direta / Indireta | Ángulo de apertura 90° + 5°

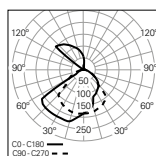

W
3
5

lm output
80
143

CÓDIGO*
90220L101E♣0♦05
90220L103E♣0♦05

Temp. de Color		♦
3000K		3
4000K		0
5700K		5

SISTEMAS Y PERFILES DE ALUMINIO



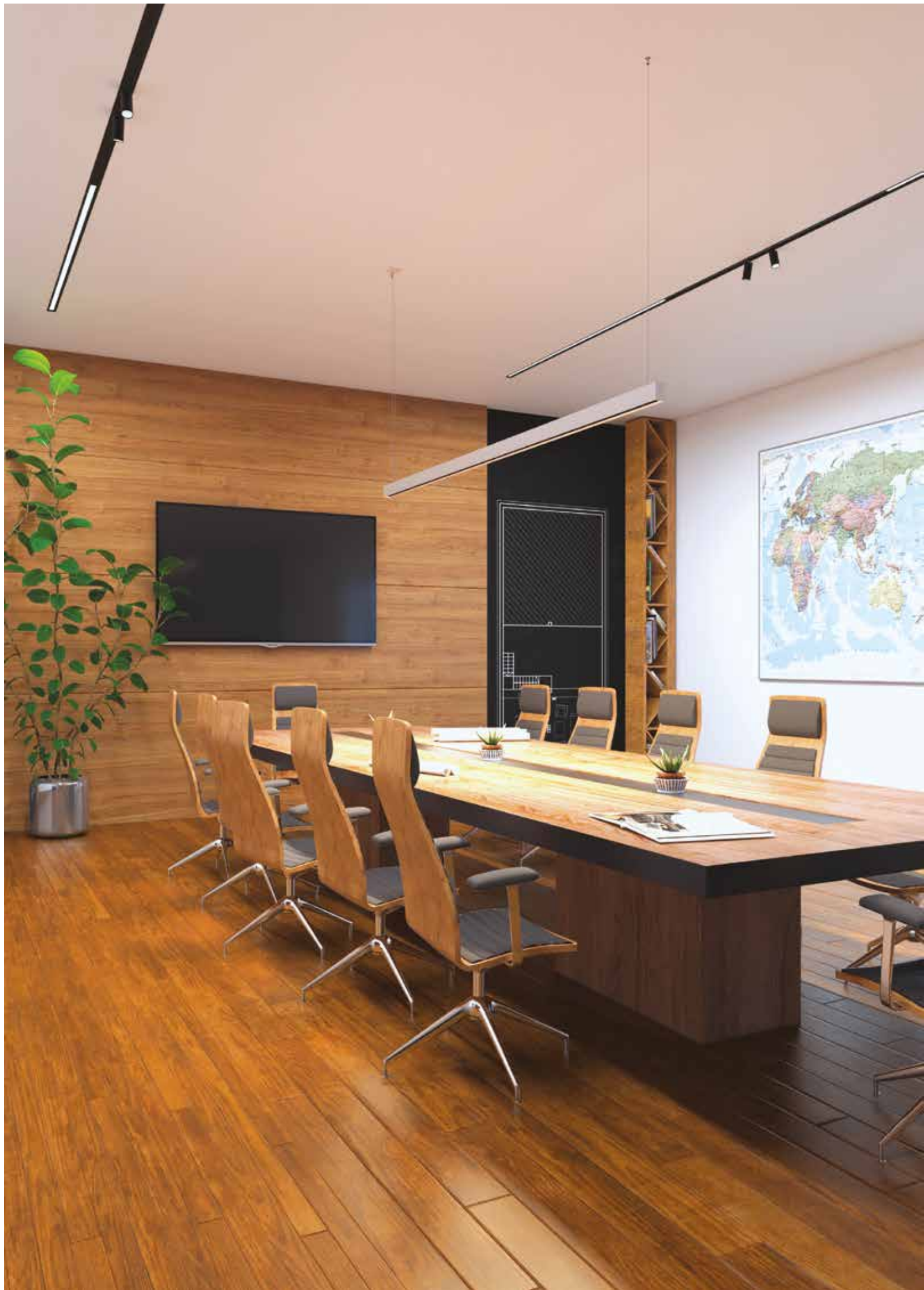

REBA 50 bOPTICS

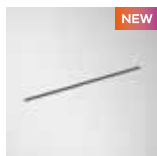

**REBA 50 /E
bOPTICS**
474

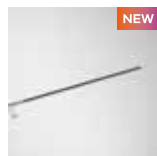

**REBA 50 /E
bOPTICS Line**
478



REBA 50 bOPTICS
484



**REBA 50 bOPTICS
Line**
488



Tipos de aplicación

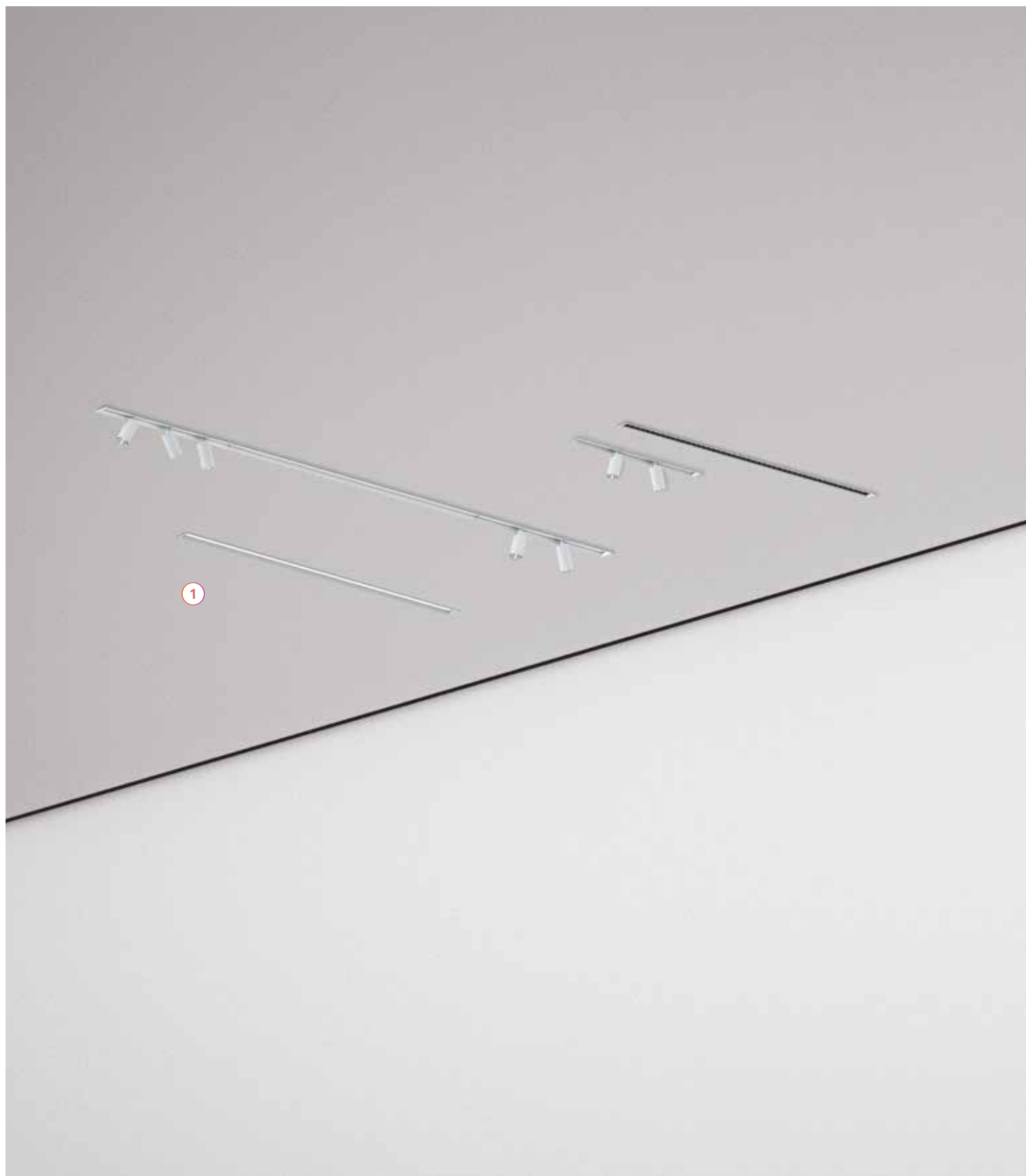

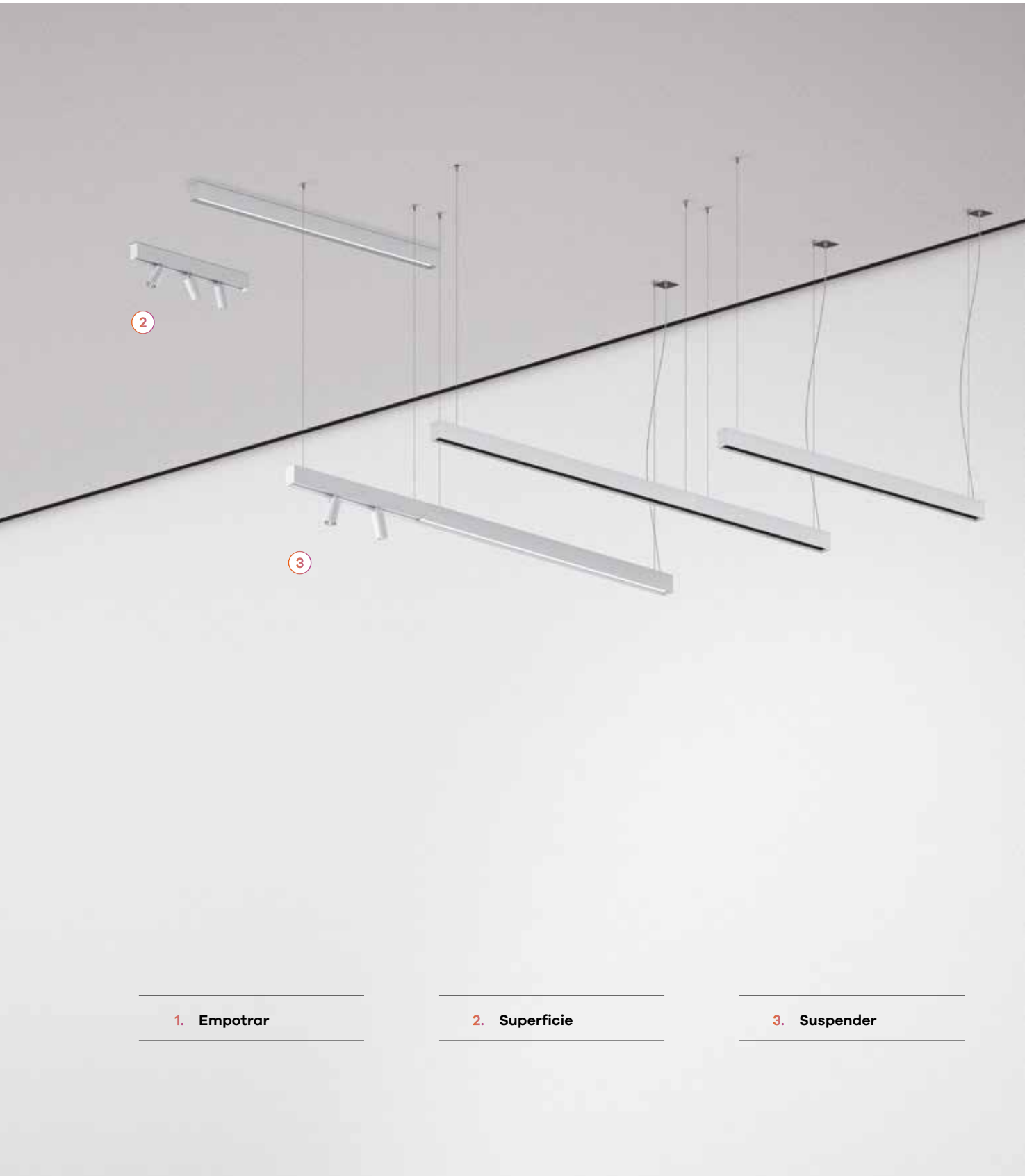

Sistema óptico

1. bFLEX

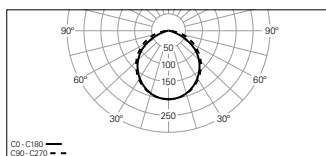

2. bOPTICS

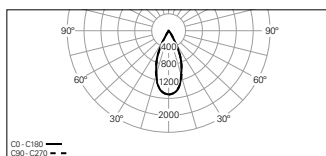

3. SPOT

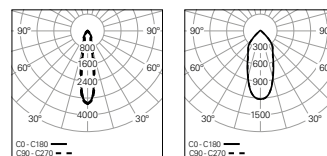



Escala 1:1

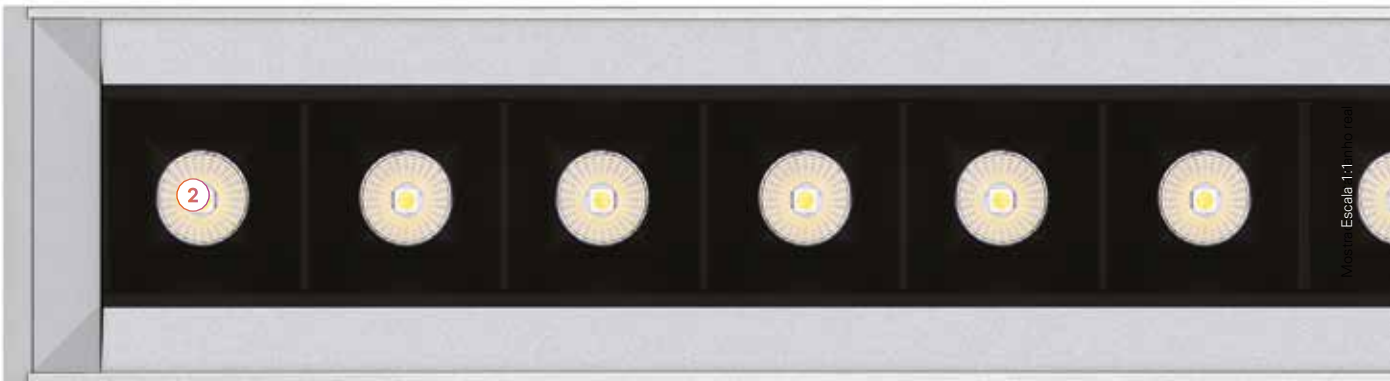

Mostrando Escala 1:1

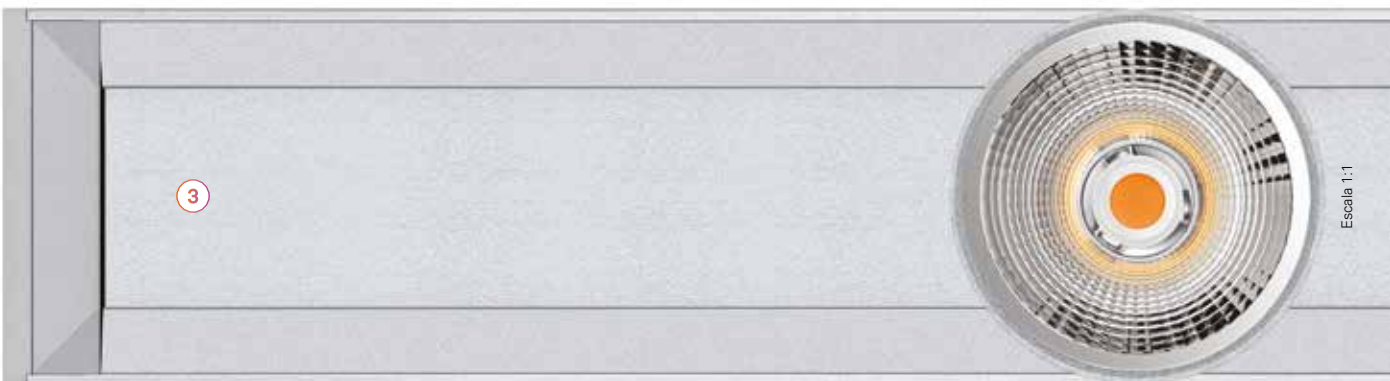

Escala 1:1

Minimalismo y tecnología

1. Perfil exterior

Perfil de aluminio extruido, disponible en 3 colores.

2. LED

SDCM MacAdam ≤ 3 , temperatura de color 3000K / 4000K, CRI > 80 y vida útil de 80.000h L90 B10.

3. bOPTICS, bFLEX o SPOT

Sistema óptico de alta tecnología con reflector bOPTICS para iluminación de alto confort visual (UGR < 10), difusor opalino difusor bFLEX que garantiza una luz sin puntos visibles o versión SPOT para iluminación de realce, con 1, 2 o 3 SPOTS disponibles.

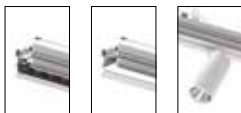

4. Tapas

Tapas sin tornillos visibles y sin salidas de luz. Disponibles en el color del producto.

5. Fuente de alimentación DALI o HF

6. Suspensión y cable de alimentación

Suspensión y cable de alimentación disponible en longitudes de 1500, 3000 o 6000 mm.



7. Base de techo

Base de techo en versión empotrada o de superficie disponibles en blanco o negro.

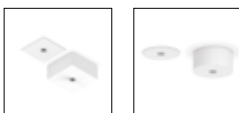

8. Unión

Los dos perfiles están perfectamente conectados para que no existan salidas de luz en cualquier aplicación de línea continua.



9. Kit de emergencia

Kit de emergencia de 3 horas. Disponible desde ≈ 1276 mm.

10. Niveladores

La versión empotrada garantiza una fácil instalación gracias a un soporte de montaje inteligente para instalación en techos de hasta 25 mm de espesor.



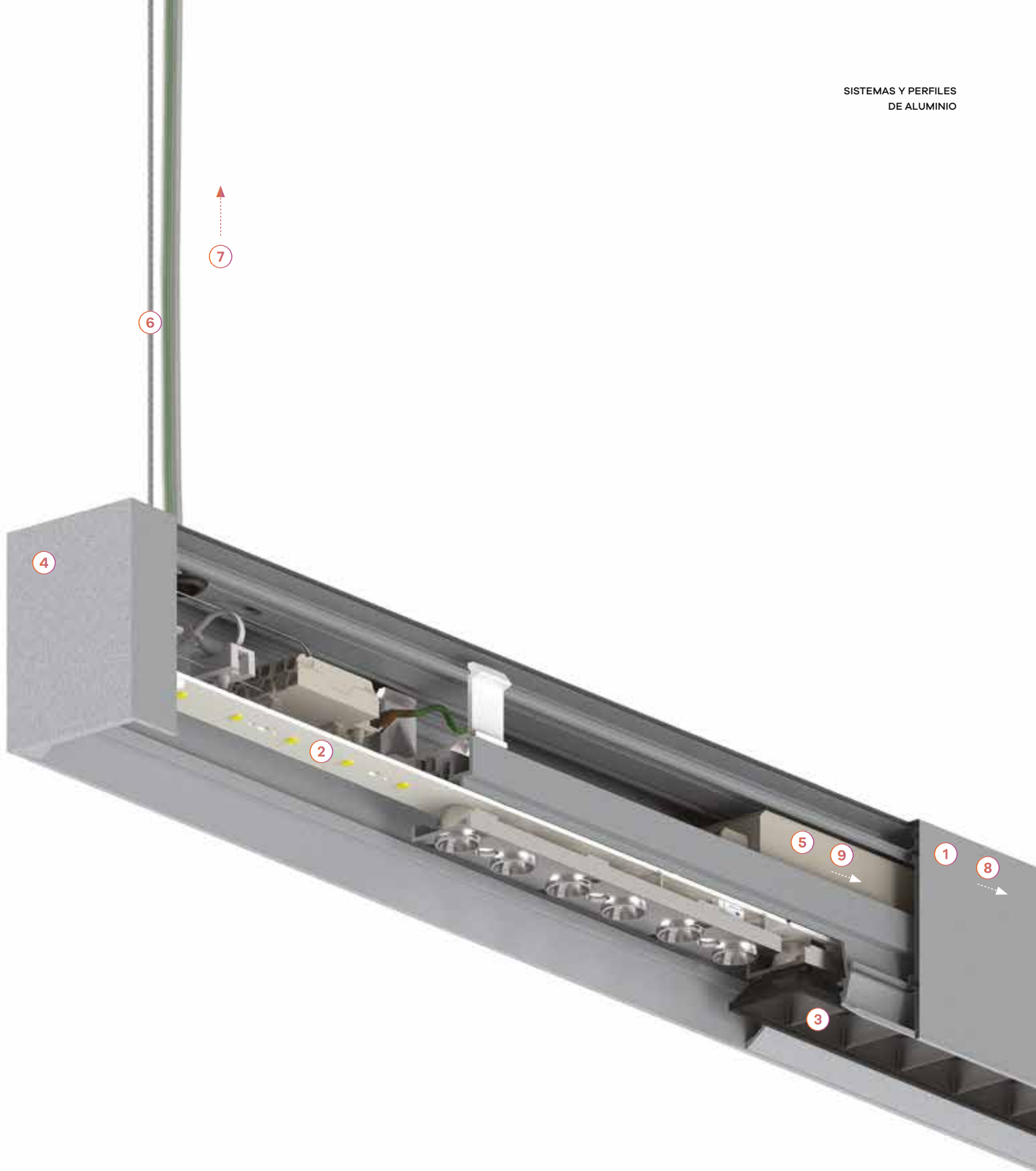

Composición de los elementos estructurales

1. Tapas

2. Perfil exterior

- 2.1 Módulo inicial/final (SRT/END).
- 2.2 Módulo intermedio (MID).

3. Perfil interior

- 3.1 bOPTICS
- 3.2 bFLEX
- 3.3 Módulo ciego
- 3.4 Spot 1
- 3.5 Spot 2
- 3.6 Spot 3

4. Uniones

5. Base de techo

6. Cable de alimentación

7. Suspensión

Módulos disponibles

(Vista desde arriba)

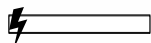

Módulo inicial/final (SRT/END)



Módulo intermedio (MID)

Cómo montar una línea

(Vista desde arriba)



Tapa

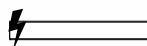

Módulo inicial/final (SRT/END)

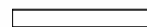

Módulo intermedio (MID)

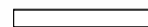

Módulo inicial/final (SRT/END)



Tapa



Diagrama de cableado para línea continua (K3)



Diagrama de cableado para línea continua (K3 + Telemando)



REBA 50 /E bOPTICS

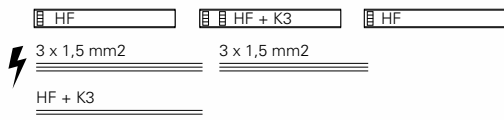
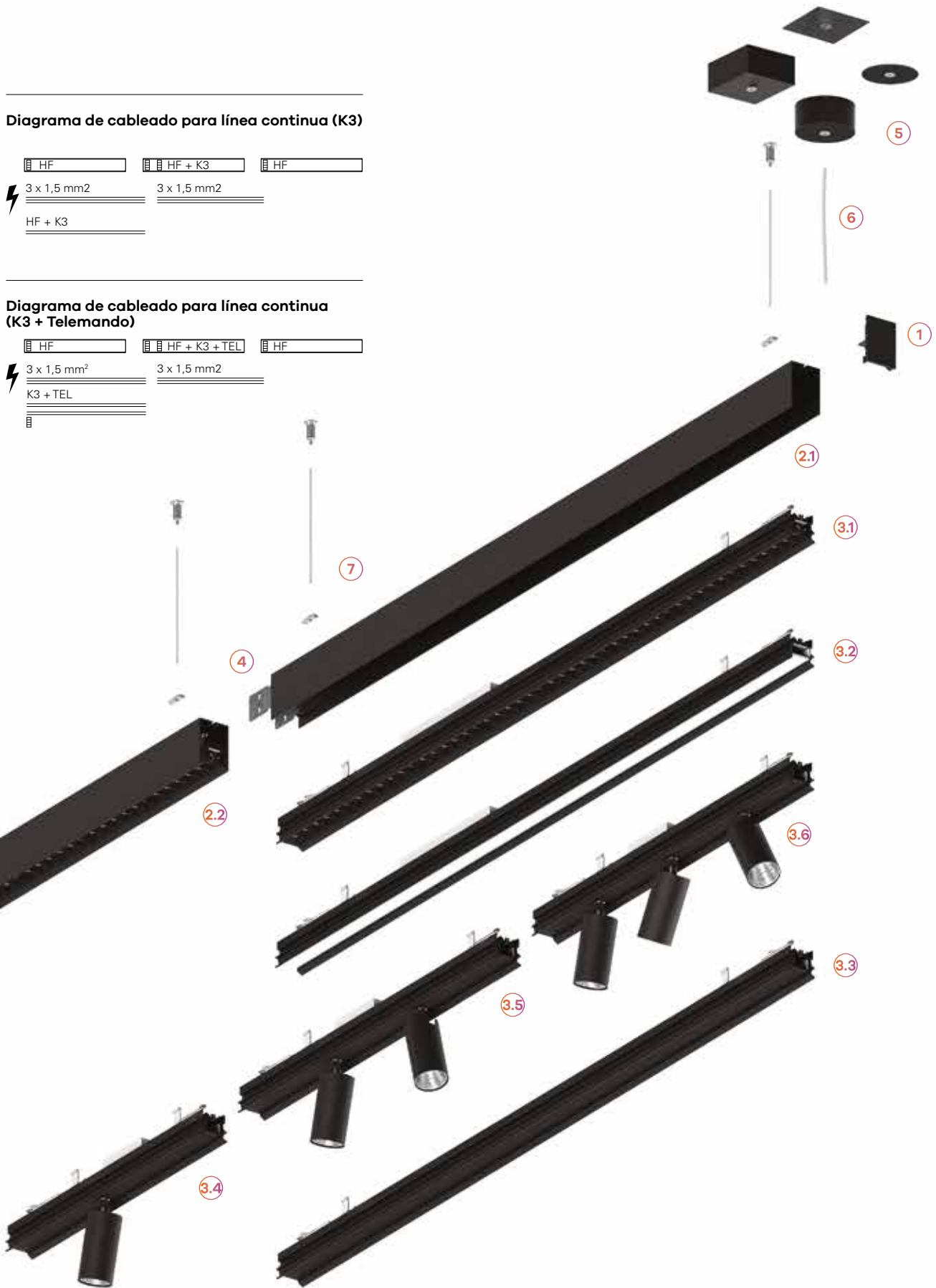
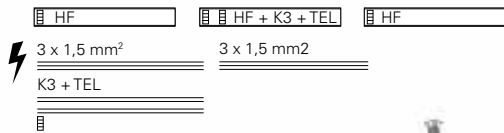

Características del producto

Cuerpo

Perfil de aluminio extruido

Acabado

Pintado en epoxi-poliéster

Sistema óptico

bFLEX - Difusor opalino

bOPTICS - Reflector simétrico

PB - Reflector brillante

Fuente de luz

Perfil interior: LED, RG1, CRI>80,

MacAdam Step ≤3

Spot: LED, RG1, CRI>90, MacAdam Step ≤3

Vida útil del LED

Perfil interior: 80.000h @ L90, B10, Ta 25°C

Spot: 86.000h @ L80, B10, Ta 25°C

Fuente de alimentación

Driver LED 220-240V-50/60Hz incluido

Espesor del techo

Para techos entre 1-25 mm

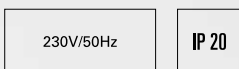

01. Seleccionar perfil exterior

PERFIL EXTERIOR

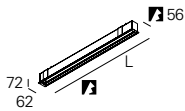

Lmm	56	CÓDIGO*
675	665	90745L0020♣0000
993	983	90745L0030♣0000
1311	1301	90745L0040♣0000
1629	1619	90745L0050♣0000
1948	1938	90745L0060♣0000
2266	2256	90745L0070♣0000
2585	2575	90745L0080♣0000
2903	2893	90745L0090♣0000



*Sustituya los símbolos para completar el código

Color	♣
□ Blanco	W
■ Gris	G
■ Negro	B

PERFIL EXTERIOR

• Para completar el producto, es necesario pedir el perfil interior por separado.

02. Seleccionar interior

PERFIL INTERIOR

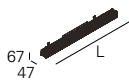

bOPTICS - Reflector simétrico 48°

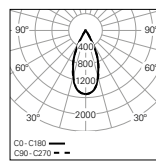

UGR	W	lm output	lm/W	Lmm	CÓDIGO*
≤10	12	1488	124	637	90747L002♥♣0♦00
≤10	18	2233	124	955	90747L003♥♣0♦00
≤10	24	2977	124	1273	90747L004♥♣♦♦00
≤10	30	3721	124	1591	90747L005♥♣♦♦00
≤10	34	4465	131	1910	90747L006♥♣♦♦00
≤10	39	5209	134	2228	90747L007♥♣♦♦00
≤10	45	5953	132	2547	90747L008♥♣♦♦00
≤10	50	6698	134	2865	90747L009♥♣♦♦00



*Sustituya los símbolos para completar el código

Fuente de alimentación	♥
HF	E
DALI	H

Color	♣
□ Blanco	W
■ Gris	G
■ Negro	B

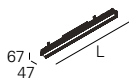

bFLEX - Difusor opalino

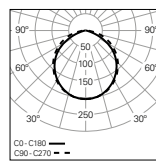

UGR	W	lm output	lm/W	Lmm	CÓDIGO*
≤25	12	1017	85	637	90748L002♥♣0♦00
≤25	18	1526	85	955	90748L003♥♣0♦00
≤25	24	2035	85	1273	90748L004♥♣♦♦00
≤25	30	2543	85	1591	90748L005♥♣♦♦00
≤25	34	3052	90	1910	90748L006♥♣♦♦00
≤25	39	3561	91	2228	90748L007♥♣♦♦00
≤25	45	4069	90	2547	90748L008♥♣♦♦00
≤25	50	4578	92	2865	90748L009♥♣♦♦00

Emergencia	♦
No EM	0
EM 3h (K3) ¹	3

Temp. de color	♦
3000K	3
4000K	0

¹ Preparado para telemando.

02. Seleccionar interior

SPOT - Proyector

Spot 1



Spot 2



Spot 3



PB - Reflector brillante 20°

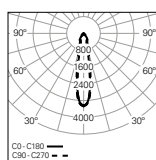

SPOT	W	lm output	lm/W	Lmm	CÓDIGO*
1	11	1168	106	318	90749L001E♣0♣♣2
1	11	1168	106	637	90749L002♥♣0♣♣2
2	21	2336	111	318	90750L001E♣0♣♣2
2	21	2336	111	637	90750L002♥♣0♣♣2
3	30	3504	117	637	90751L002♥♣0♣♣2

PB - Reflector brillante 50°

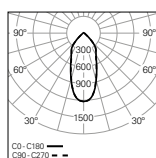

SPOT	W	lm output	lm/W	Lmm	CÓDIGO*
1	11	1144	104	318	90749L001E♣0♣♣5
1	11	1144	104	637	90749L002♥♣0♣♣5
2	21	2288	109	318	90750L001E♣0♣♣5
2	21	2288	109	637	90750L002♥♣0♣♣5
3	30	3431	114	637	90751L002♥♣0♣♣5



*Sustituya los símbolos para completar el código

Fuente de alimentación ▼

HF E
DALI H

Color ▲/▲

□ Blanco W/W
■ Negro B/B
■ Gris G/G

□ Blanco/
Negro W/B
■ Negro/
Blanco B/W
■ Negro/
Golden eye B/D



Leyenda:

1. Cuerpo
2. Spot

Temp. de color ◆

3000K B
4000K A

03. Seleccionar opciones

OPCIONES	Código
Cable de seguridad en acero L1500 mm	955000
Versión de baja potencia • Mediante solicitud.	



Detalles del producto



Perfil exterior



Nivelador



Aplicación de empotrar

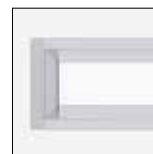

Difusor bFLEX



Difusor bOPTICS



Spot orientable



Acabado Blanco



Acabado Negro



Acabado gris



Acabado Blanco/Negro



Acabado Negro/Blanco



Acabado Negro/Golden Eye

REBA 50 /E bOPTICS Line



Características del producto

Cuerpo

Perfil de aluminio extruido

Acabado

Pintado en epoxi-poliéster

Sistema óptico

bFLEX - Difusor opalino

bOPTICS - Reflector simétrico

PB - Reflector brillante

Fuente de luz

Perfil interior: LED, RG1, CRI>80,

MacAdam Step ≤3

Spot: LED, RG1, CRI>90, MacAdam Step ≤3

Vida útil del LED

Perfil interior: 80.000h @ L90, B10, Ta 25°C

Spot: 86.000h @ L80, B10, Ta 25°C

Fuente de alimentación

Driver LED 220-240V-50/60Hz incluido

Espesor del techo

Para techos entre 1-25 mm

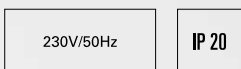

01. Seleccionar perfil exterior

PERFIL EXTERIOR

Inicial / Final (SRT/END)

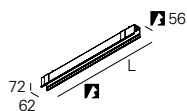

Lmm	56	CÓDIGO*
647	648	90746L0020▲0083
965	966	90746L0030▲0083
1283	1284	90746L0040▲0083
1601	1602	90746L0050▲0083
1920	1921	90746L0060▲0083
2238	2239	90746L0070▲0083
2557	2558	90746L0080▲0083
2875	2876	90746L0090▲0083

Intermedio (MID)

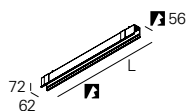

Lmm	56	CÓDIGO*
637	637	90746L0020▲0000
955	955	90746L0030▲0000
1273	1273	90746L0040▲0000
1591	1591	90746L0050▲0000
1910	1910	90746L0060▲0000
2228	2228	90746L0070▲0000
2547	2547	90746L0080▲0000
2865	2865	90746L0090▲0000

PERFIL EXTERIOR

- Para completar el producto, es necesario pedir el perfil interior por separado.
- Para completar una línea, es necesario un Start Kit, cableado de línea continua y kit de unión. Por favor solicítelo por separado.
- Las dimensiones no incluyen Start Kit. Para completar la dimensión empotrada de la línea, incremente 6 mm a la longitud de corte.
- La longitud máxima de línea con un solo punto de alimentación es de 30000 mm.



*Sustituya los símbolos para completar el código

Color	▲
□ Blanco	W
■ Gris	G
■ Negro	B

02. Seleccionar interior

PERFIL INTERIOR

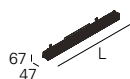

bOPTICS - Reflector simétrico 48°

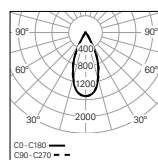

UGR	W	lm output	lm/W	Lmm	CÓDIGO*
≤10	12	1488	124	637	90747L002▼▲0♦00
≤10	18	2233	124	955	90747L003▼▲0♦00
≤10	24	2977	124	1273	90747L004▼▲0♦00
≤10	30	3721	124	1591	90747L005▼▲0♦00
≤10	34	4465	131	1910	90858L006▼▲0♦00
≤10	39	5209	134	2228	90858L007▼▲0♦00
≤10	45	5953	132	2547	90858L008▼▲0♦00
≤10	50	6698	134	2865	90858L009▼▲0♦00

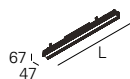

bFLEX - Difusor opalino

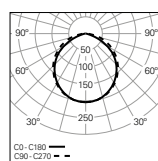

UGR	W	lm output	lm/W	Lmm	CÓDIGO*
≤25	12	1017	85	637	90748L002▼▲0♦00
≤25	18	1526	85	955	90748L003▼▲0♦00
≤25	24	2035	85	1273	90748L004▼▲0♦00
≤25	30	2543	85	1591	90748L005▼▲0♦00
≤25	34	3052	90	1910	90859L006▼▲0♦00
≤25	39	3561	91	2228	90859L007▼▲0♦00
≤25	45	4069	90	2547	90859L008▼▲0♦00
≤25	50	4578	92	2865	90859L009▼▲0♦00



*Sustituya los símbolos para completar el código

Fuente de alimentación	▼
HF	E
DALI	H

Color	▲
□ Blanco	W
■ Gris	G
■ Negro	B

Emergencia	●
No EM	0
EM 3h (K3) ¹	3

Temp. de color	♦
3000K	3
4000K	0

¹ Preparado para telemando.

02. Seleccionar interior

SPOT - Proyector

Spot 1



Spot 2



Spot 3



PB - Reflector brillante 20°

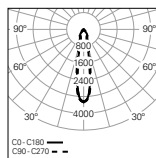

SPOT	W	lm output	lm/W	Lmm	CÓDIGO*
1	11	1168	106	318	90749L001E♣0♣♠2
1	11	1168	106	637	90749L002♥♣0♣♠2
2	21	2336	111	318	90750L001E♣0♣♠2
2	21	2336	111	637	90750L002♥♣0♣♠2
3	30	3504	117	637	90751L002♥♣0♣♠2

PB - Reflector brillante 50°

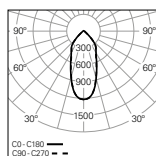

SPOT	W	lm output	lm/W	Lmm	CÓDIGO*
1	11	11	11	318	90749L001E♣0♣♠5
1	11	11	11	637	90749L002♥♣0♣♠5
2	21	21	21	318	90750L001E♣0♣♠5
2	21	21	21	637	90750L002♥♣0♣♠5
3	30	30	30	637	90751L002♥♣0♣♠5

SPOT - Proyector

- La versión SPOT L318 mm apenas puede ser aplicado no fim da linha (END).



*Sustituya los símbolos para completar el código

Fuente de alimentación ▼

HF E
DALI H

Color ♣/♠

□ Blanco W/W
■ Negro B/B
■ Gris G/G

□ Blanco/
Negro W/B
■ Negro/
Blanco B/W
■ Negro/
Golden eye B/D

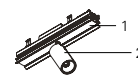

Leyenda:

1. Cuerpo
2. Spot

Temp. de color ♦

3000K B
4000K A

MÓDULO CIEGO

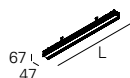

Lmm	CÓDIGO*
318	90744L0010♣0000
637	90744L0020♣0000
955	90744L0030♣0000
1273	90744L0040♣0000
1591	90744L0050♣0000
1910	90744L0060♣0000
2228	90744L0070♣0000
2547	90744L0080♣0000
2865	90744L0090♣0000



*Sustituya los símbolos para completar el código

Color ♣

□ Blanco W
■ Gris G
■ Negro B

03. Seleccionar opciones

OPCIONES	Código*
Start kit - Tapas inicio/final • Dos tapas finales incluidas.	72 9 62 9 923210
Cableado de línea continua	
• Estándar	
3 x 1,5 mm ²	945650
5 x 1,5 mm ²	945750
• 2 x 1,5 mm²	
HF+K3 (x1) - L638 - L1914 mm	948000
HF+K3 (x2) - L2233 - L2871 mm	948001
• 2 x 1,5 mm² + Borna de conexión 5P	
DALI+K3 (x1) - L638 - L1914 mm	948200
DALI+K3 (x2) - L2233 - L2871 mm	948201
• 2 x 1,5 mm² + 2 x 0,75 mm² + Borna de conexión 5P	
K3+TEL (x1) - L638 - L1914 mm	948100
K3+TEL (x2) - L2233 - L2871 mm	948101
Kit de unión	932100
• Unión galvanizada, tornillos incluidos.	
Cable de seguridad en acero	955000
L1500 mm	
Versión de baja potencia	
• Mediante solicitud.	
Proyectos a medida	
• Mediante solicitud.	



*Sustituya los símbolos para completar el código

Color	♣
<input type="checkbox"/> Blanco	W
<input type="checkbox"/> Gris	G
<input type="checkbox"/> Negro	B



Detalles del producto



Perfil exterior



Niveladores



Aplicación de empotrar

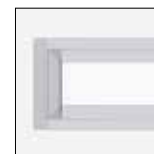

Difusor bFLEX



Difusor bOPTICS



Spot orientable



Acabado blanco



Acabado Negro



Acabado gris



Acabado Blanco/Negro



Acabado Negro/Blanco



Acabado Negro/Golden Eye



Start Kit



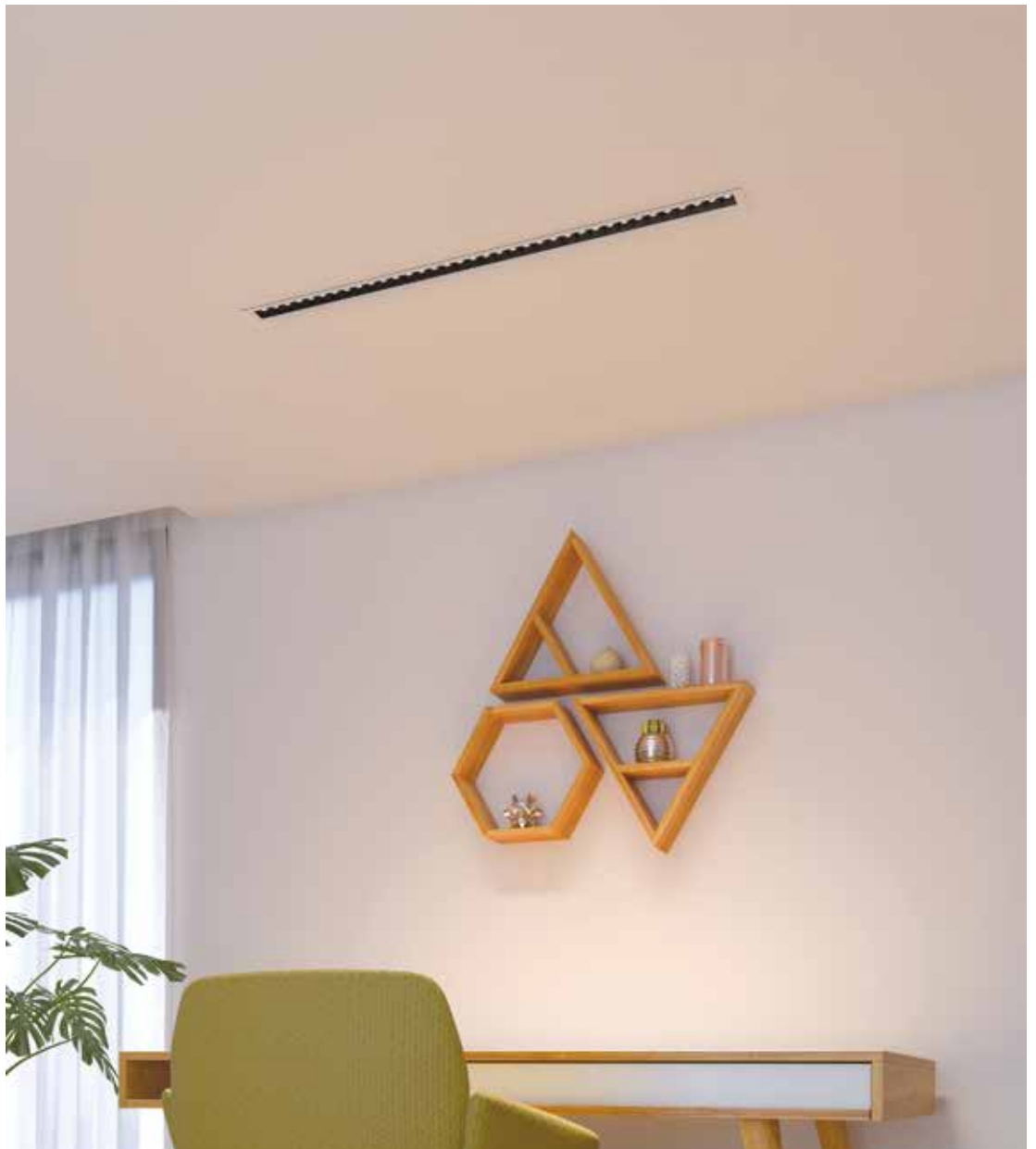

REBA 50 bOPTICS



Características del producto

Cuerpo

Perfil de aluminio extruido

Acabado

Pintado en epoxi-poliéster

Sistema óptico

bFLEX - Difusor opalino

bOPTICS - Reflector simétrico

PB - Reflector brillante

Fuente de luz

Perfil interior: LED, RG1, CRI>80,

MacAdam Step ≤3

Spot: LED, RG1, CRI>90, MacAdam Step ≤3

Vida útil del LED

Perfil interior: 80.000h @ L90, B10, Ta 25°C

Spot: 86.000h @ L80, B10, Ta 25°C

Fuente de alimentación

Driver LED 220-240V-50/60Hz incluido

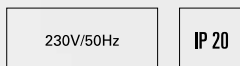

01. Seleccionar perfil exterior

PERFIL EXTERIOR

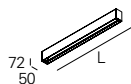

Lmm	CÓDIGO*
663	90737L0020▲0000
981	90737L0030▲0000
1299	90737L0040▲0000
1617	90737L0050▲0000
1936	90737L0060▲0000
2254	90737L0070▲0000
2573	90737L0080▲0000
2891	90737L0090▲0000



*Sustituya los símbolos para completar el código

Color	▲
□ Blanco	W
■ Gris	G
■ Negro	B

PERFIL EXTERIOR

- Para completar el producto, es necesario pedir el perfil interior por separado.
- Para la versión suspendida, es necesario pedir suspensiones, cable y base de alimentación por separado.

02. Seleccionar interior

PERFIL INTERIOR

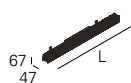

bOPTICS - Reflector simétrico 48°

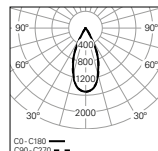

UGR	W	lm output	lm/W	Lmm	CÓDIGO*
≤10	12	1488	124	637	90747L002▼▲0♦00
≤10	18	2233	124	955	90747L003▼▲0♦00
≤10	24	2977	124	1273	90747L004▼▲0♦00
≤10	30	3721	124	1591	90747L005▼▲0♦00
≤10	34	4465	131	1910	90747L006▼▲0♦00
≤10	39	5209	134	2228	90747L007▼▲0♦00
≤10	45	5953	132	2547	90747L008▼▲0♦00
≤10	50	6698	134	2865	90747L009▼▲0♦00

*Sustituya los símbolos para completar el código

Fuente de alimentación	▼
HF	E
DALI	H

Color	▲
□ Blanco	W
■ Gris	G
■ Negro	B

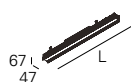

bFLEX - Difusor opalino

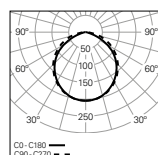

UGR	W	lm output	lm/W	Lmm	CÓDIGO*
≤25	12	1017	85	637	90748L002▼▲0♦00
≤25	18	1526	85	955	90748L003▼▲0♦00
≤25	24	2035	85	1273	90748L004▼▲0♦00
≤25	30	2543	85	1591	90748L005▼▲0♦00
≤25	34	3052	90	1910	90748L006▼▲0♦00
≤25	39	3561	91	2228	90748L007▼▲0♦00
≤25	45	4069	90	2547	90748L008▼▲0♦00
≤25	50	4578	92	2865	90748L009▼▲0♦00

Emergencia	●
No EM	0
EM 3h (K3) ¹	3

Temp. de color	♦
3000K	3
4000K	0

¹ Preparado para telemando.

02. Seleccionar interior

SPOT - Proyector

Spot 1



Spot 2



Spot 3



PB - Reflector brillante 20°

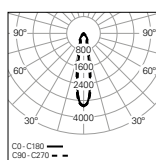

SPOT	W	lm output	lm/W	Lmm	CÓDIGO*
1	11	1168	106	318	90749L001E♣0♣♣2
1	11	1168	106	637	90749L002♥♣0♣♣2
2	21	2336	111	318	90750L001E♣0♣♣2
2	21	2336	111	637	90750L002♥♣0♣♣2
3	30	3504	117	637	90751L002♥♣0♣♣2

PB - Reflector brillante 50°

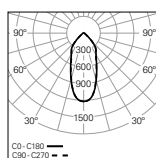

SPOT	W	lm output	lm/W	Lmm	CÓDIGO*
1	11	1144	104	318	90749L001E♣0♣♣5
1	11	1144	104	637	90749L002♥♣0♣♣5
2	21	2288	109	318	90750L001E♣0♣♣5
2	21	2288	109	637	90750L002♥♣0♣♣5
3	30	3431	114	637	90751L002♥♣0♣♣5



*Sustituya los
símbolos para
completar el código

Fuente de alimentación ▼

HF E
DALI H

Color ▲/▲

□ Blanco W/W
■ Negro B/B
■ Gris G/G

□ Blanco/
Negro W/B
■ Negro/
Blanco B/W
■ Negro/
Golden eye B/D

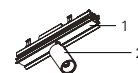

Leyenda:

1. Cuerpo
2. Spot

Temp. de color ◆

3000K B
4000K A

03. Seleccionar opciones

OPCIONES	Código*
Suspensión	
S5 L1500 mm (x1)	910408
S5 L1500 mm (x2)	910409
S5 L3000 mm (x1)	910419
S5 L3000 mm (x2)	910412
S5 L6000 mm (x1)	910420
S5 L6000 mm (x2)	910421
Cable de alimentación transparente	
L1500 mm - 3 x 0,75 mm ²	940400
L1500 mm - 5 x 0,75 mm ²	940500
L1500 mm - 7 x 0,75 mm ²	940600
L3000 mm - 3 x 0,75 mm ²	940401
L3000 mm - 5 x 0,75 mm ²	940501
L3000 mm - 7 x 0,75 mm ²	940601
L6000 mm - 3 x 0,75 mm ²	940402
L6000 mm - 5 x 0,75 mm ²	940507
L6000 mm - 7 x 0,75 mm ²	940602
• Para la opción DALI con kit de emergencia teledomable, es necesario solicitar 2 cables de alimentación de 5 x 0,75 mm ² .	
Base cuadrada	
Superficie T25  45  100	978610▲
Superficie T29 (DALI+K3)	978611▲
Empotrar T7  Ø70 35  90	971400▲
Empotrar T59 (DALI+K3)	971410▲
Base circular	
Superficie T24  Ø95	978600▲
Superficie T26 (DALI+K3)	978601▲
Empotrar T5  Ø70 33  Ø90	971300▲
Empotrar T27 (DALI+K3)	978700▲
Versión de baja potencia	
• Mediante solicitud.	



*Sustituya los símbolos para completar el código

Color ▲
 Blanco W
 Negro B



Detalles del producto



Perfil exterior

Tapas sin tornillos visibles

Suspensión



Aplicación de superficie

Aplicación suspendida

Difusor bFLEX



Difusor bOPTICS

Spot orientable

Acabado blanco



Acabado negro

Acabado gris

Acabado Blanco/Negro



Acabado Negro/Blanco

Acabado Negro/Golden Eye

Base cuadrada



Base circular

REBA 50 bOPTICS Line



Características del producto

Cuerpo

Perfil de aluminio extruido

Acabado

Pintado en epoxi-poliéster

Sistema óptico

bFLEX - Difusor opalino

bOPTICS - Reflector simétrico

PB - Reflector brillante

Fuente de luz

Perfil interior: LED, RG1, CRI>80,

MacAdam Step ≤3

Spot: LED, RG1, CRI>90, MacAdam Step ≤3

Vida útil del LED

Perfil interior: 80.000 @ L90, B10, Ta 25°C

Spot: 86.000h @ L80, B10, Ta 25°C

Fuente de alimentación

Driver LED 220-240V-50/60Hz incluido

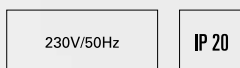

01. Seleccionar perfil exterior



PERFIL EXTERIOR

Inicial / Final (SRT/END)

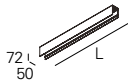

Lmm	CÓDIGO*
647	90738L0020♣0083
965	90738L0030♣0083
1283	90738L0040♣0083
1601	90738L0050♣0083
1920	90738L0060♣0083
2238	90738L0070♣0083
2557	90738L0080♣0083
2875	90738L0090♣0083

*Sustituya los símbolos para completar el código

Color	♣
□ Blanco	W
■ Gris	G
■ Negro	B

Intermedio (MID)

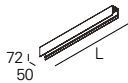

Lmm	CÓDIGO*
637	90738L0020♣0000
955	90738L0030♣0000
1273	90738L0040♣0000
1591	90738L0050♣0000
1910	90738L0060♣0000
2228	90738L0070♣0000
2547	90738L0080♣0000
2865	90738L0090♣0000

PERFIL EXTERIOR

- Para completar el producto, es necesario pedir el perfil interior por separado.
- Para la versión suspendida, es necesario pedir suspensiones, cable y base de alimentación por separado.
- Para completar una línea, es necesario un Start Kit, cableado de línea continua y kit de unión. Por favor solicítelo por separado.
- Las dimensiones no incluyen el star kit. Incremente 6 mm a la longitud para completar la línea.
- La longitud máxima de línea con un solo punto de alimentación es de 30000 mm.

02. Seleccionar interior



PERFIL INTERIOR

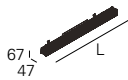

bOPTICS - Reflector simétrico 48°

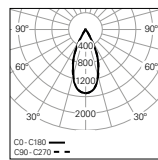

UGR	W	lm output	lm/W	Lmm	CÓDIGO*
≤10	12	1488	124	637	90747L002♥♣0♦00
≤10	18	2233	124	955	90747L003♥♣0♦00
≤10	24	2977	124	1273	90747L004♥♣0♦00
≤10	30	3721	124	1591	90747L005♥♣0♦00
≤10	34	4465	131	1910	90858L006♥♣0♦00
≤10	39	5209	134	2228	90858L007♥♣0♦00
≤10	45	5953	132	2547	90858L008♥♣0♦00
≤10	50	6698	134	2865	90858L009♥♣0♦00

*Sustituya los símbolos para completar el código

Fuente de alimentación	♥
HF	E
DALI	H

Color	♣
□ Blanco	W
■ Gris	G
■ Negro	B

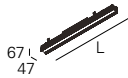

bFLEX - Difusor opalino

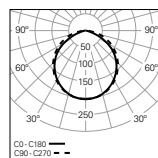

UGR	W	lm output	lm/W	Lmm	CÓDIGO*
≤25	12	1017	85	637	90748L002♥♣0♦00
≤25	18	1526	85	955	90748L003♥♣0♦00
≤25	24	2035	85	1273	90748L004♥♣0♦00
≤25	30	2543	85	1591	90748L005♥♣0♦00
≤25	34	3052	90	1910	90859L006♥♣0♦00
≤25	39	3561	91	2228	90859L007♥♣0♦00
≤25	45	4069	90	2547	90859L008♥♣0♦00
≤25	50	4578	92	2865	90859L009♥♣0♦00

Emergencia	●
No EM	0
EM 3h (K3) ¹	3

Temp. de color	♦
3000K	3
4000K	0

¹ Preparado para telemando.

02. Seleccionar interior

SPOT - Proyector

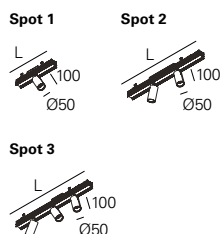

PB - Reflector brillante 20°

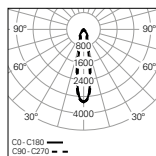

SPOT	W	Im output	lm/W	Lmm	CÓDIGO*
1	11	1168	106	318	90749L001E♣0♣♠2
1	11	1168	106	637	90749L002♥♣0♣♠2
2	21	2336	111	318	90750L001E♣0♣♠2
2	21	2336	111	637	90750L002♥♣0♣♠2
3	30	3504	117	637	90751L002♥♣0♣♠2

PB - Reflector brillante 50°

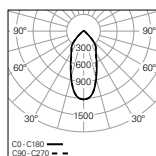

SPOT	W	Im output	lm/W	Lmm	CÓDIGO*
1	11	1144	104	318	90749L001E♣0♣♠5
1	11	1144	104	637	90749L002♥♣0♣♠5
2	21	2288	109	318	90750L001E♣0♣♠5
2	21	2288	109	637	90750L002♥♣0♣♠5
3	30	3431	114	637	90751L002♥♣0♣♠5

SPOT - Proyector

• La versión SPOT L318 mm apenas puede ser aplicado no fim da linha (END).



*Sustituya los símbolos para completar el código

Fuente de alimentación ▼

HF E
DALI H

Color ♣/♠

□ Blanco W/W
■ Negro B/B
■ Gris G/G

□ Blanco/
Negro W/B
■ Negro/
Blanco B/W
■ Negro/
Golden eye B/D



Leyenda:

1. Cuerpo
2. Spot

Temp. de color ♦

3000K B
4000K A

MÓDULO CIEGO

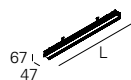

Lmm	CÓDIGO*
318	90744L0010♣0000
637	90744L0020♣0000
955	90744L0030♣0000
1273	90744L0040♣0000
1591	90744L0050♣0000
1910	90744L0060♣0000
2228	90744L0070♣0000
2547	90744L0080♣0000
2865	90744L0090♣0000









*Sustituya los símbolos para completar el código

Color ♣

□ Blanco W
■ Gris G
■ Negro B

03. Seleccionar opciones

OPCIONES		Código*
Start kit - Tapas inicio/final	72  3	923110▲
• Dos tapas finales incluidas.	50	
Cableado de línea continua		
• Estándar		
3 x 1,5 mm ²		945650
5 x 1,5 mm ²		945750
• 2 x 1,5 mm²		
HF+K3 (x1) - L638 - L1914 mm		948000
HF+K3 (x2) - L2233 - L2871 mm		948001
• 2 x 1,5 mm² + Borna de conexión 5P		
DALI+K3 (x1) - L638 - L1914 mm		948200
DALI+K3 (x2) - L2233 - L2871 mm		948201
• 2 x 1,5 mm² + 2 x 0,75 mm² + Borna de conexión 5P		
K3+TEL (x1) - L638 - L1914 mm		948100
K3+TEL (x2) - L2233 - L2871 mm		948101
Kit de unión		932100
• Unión galvanizada, tornillos incluidos.		
Suspensión		
S5 L1500 mm (x1)		910408
S5 L1500 mm (x2)		910409
S5 L3000 mm (x1)		910419
S5 L3000 mm (x2)		910412
S5 L6000 mm (x1)		910420
S5 L6000 mm (x2)		910421
Cable de alimentación transparente		
3 x 1,5 mm ²		94030▲
5 x 1,5 mm ²		94000▲
7 x 1,5 mm ²		94010▲
• Para la opción DALI con kit de emergencia telemandable, es necesario solicitar 2 cables de alimentación de 5 x 1,5 mm ² .		
Base cuadrada³		
Superficie T25	45  100	978610▲
Superficie T29 (DALI+K3)		978611▲
Empotrar T7	 Ø70 35  90	971400▲
Empotrar T59 (DALI+K3)		971410▲
Base circular³		
Superficie T24	45  Ø95	978600▲
Superficie T26 (DALI+K3)		978601▲
Empotrar T5	 Ø70 33  Ø90	971300▲
Empotrar T27 (DALI+K3)		978700▲
Versión de baja potencia		
• Mediante solicitud.		
Proyectos a medida		
• Mediante solicitud.		



*Sustituya los símbolos para completar el código

Longitud	▲
L1500 mm	0
L3000 mm	1
L6000 mm	2

Color ³	▲
<input type="checkbox"/> Blanco	W
<input type="checkbox"/> Gris	G
<input type="checkbox"/> Negro	B



Detalles del producto



³ Bases de techo solo están disponibles en blanco o negro.







Sistemas y perfiles
de aluminio

REBA



REBA 50 /T
512



REBA 50 /T Line
516



REBA 50 /E
522



REBA 50 /E Line
526



REBA 50
532



REBA 50 Line
536



REBA 50 HEXA
546



REBA 50 D/I
550



REBA 50 D/I Line
554



REBA 50 /W
560



REBA 50 /W Line
564



REBA 65 /T
574



REBA 65 /T Line
578



REBA 65 /E
584



REBA 65 /E Line
588



REBA 65
594



REBA 65 Line
598



REBA 65 D/I
604



REBA 65 D/I Line
608



Tipos de aplicación

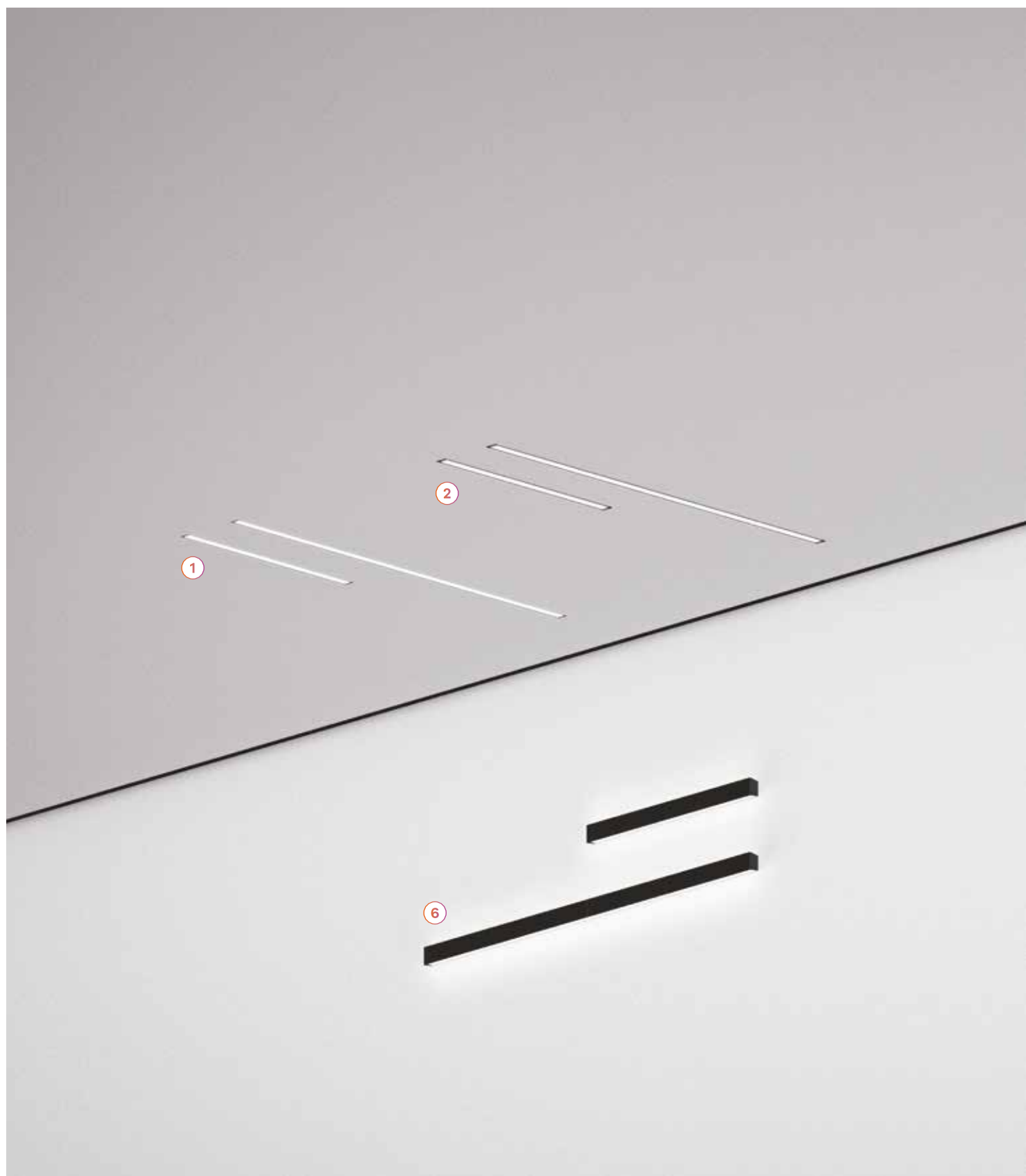

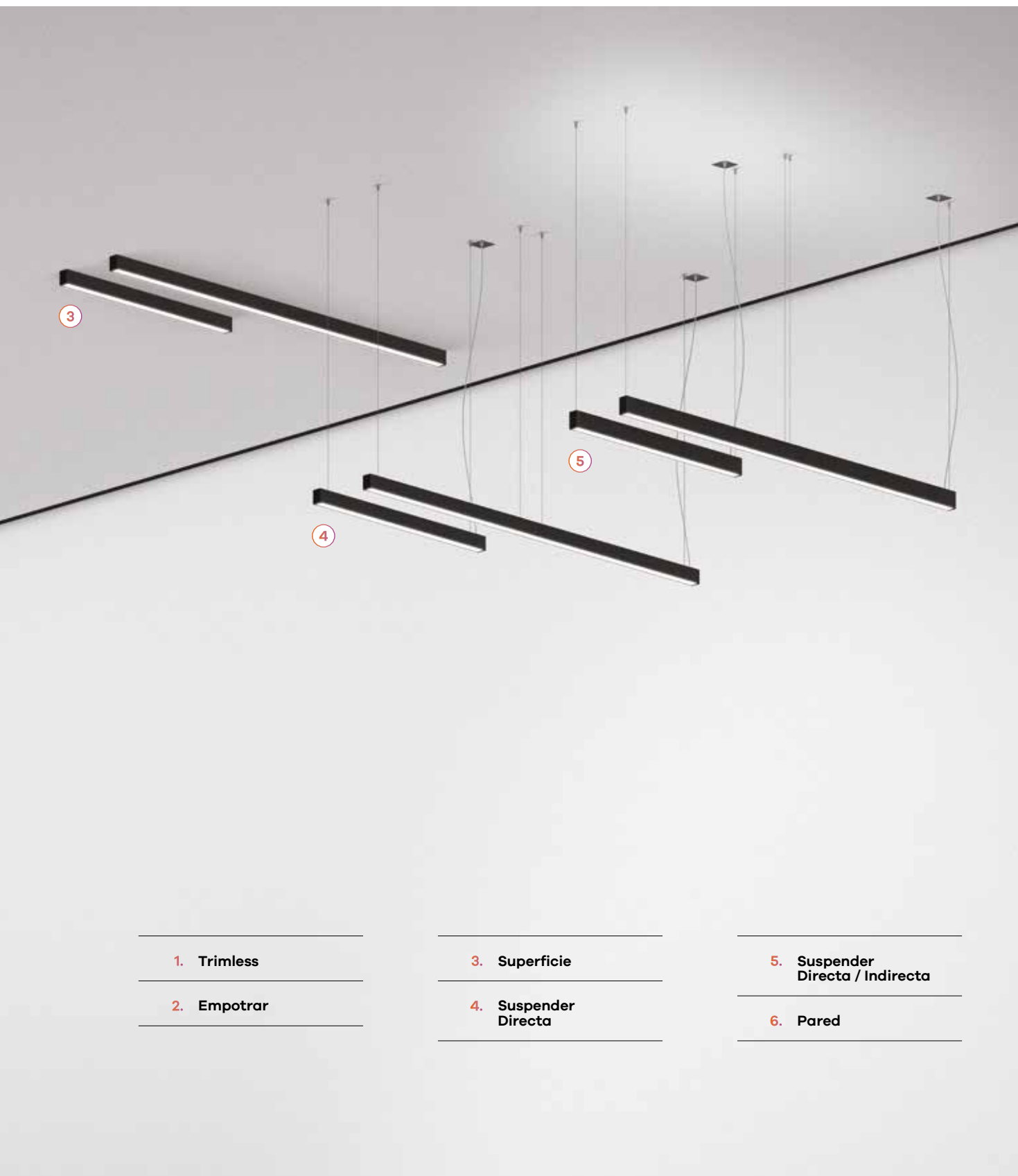

3

4

5

1. Trimless

2. Empotrar

3. Superficie

4. Suspender
Directa

5. Suspender
Directa / Indirecta

6. Pared

Sistema óptico

1. bGLARE

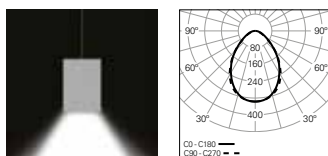

2. bLINE

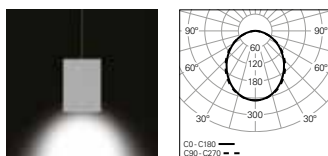

3. ASYM

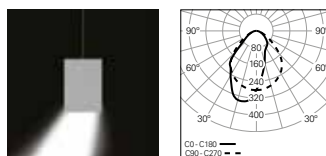

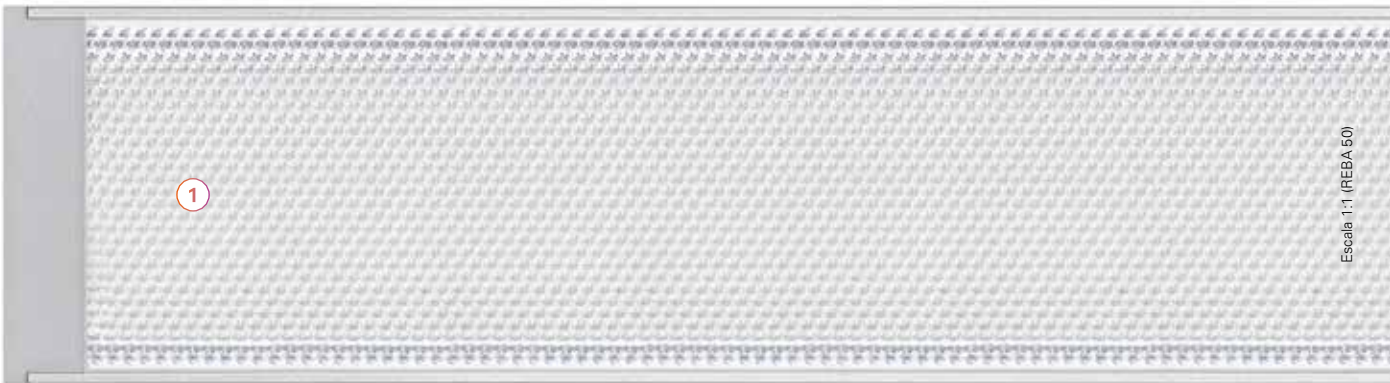

Escala 1:1 (REBA 50)



Escala 1:1 (REBA 50)



Escala 1:1 (REBA 50)

Una gama de posibilidades infinita



Empotrar
trimless



Empotrable
con marco



Superficie o
Suspendida



Suspender
Directa / Indirecta



Pared



Linear

≈560 mm	•	•	•		
≈840 mm	•	•	•		
≈1120 mm	•	•	•	•	•
≈1400 mm	•	•	•	•	•
≈1680 mm	•	•	•	•	•
≈1960 mm	•	•	•	•	•
≈2240 mm	•	•	•	•	•
≈2520 mm	•	•	•	•	•
≈2800 mm	•	•	•	•	•

Ángulo iluminado

≈600x600 mm	•	•	•	•	•
-------------	---	---	---	---	---

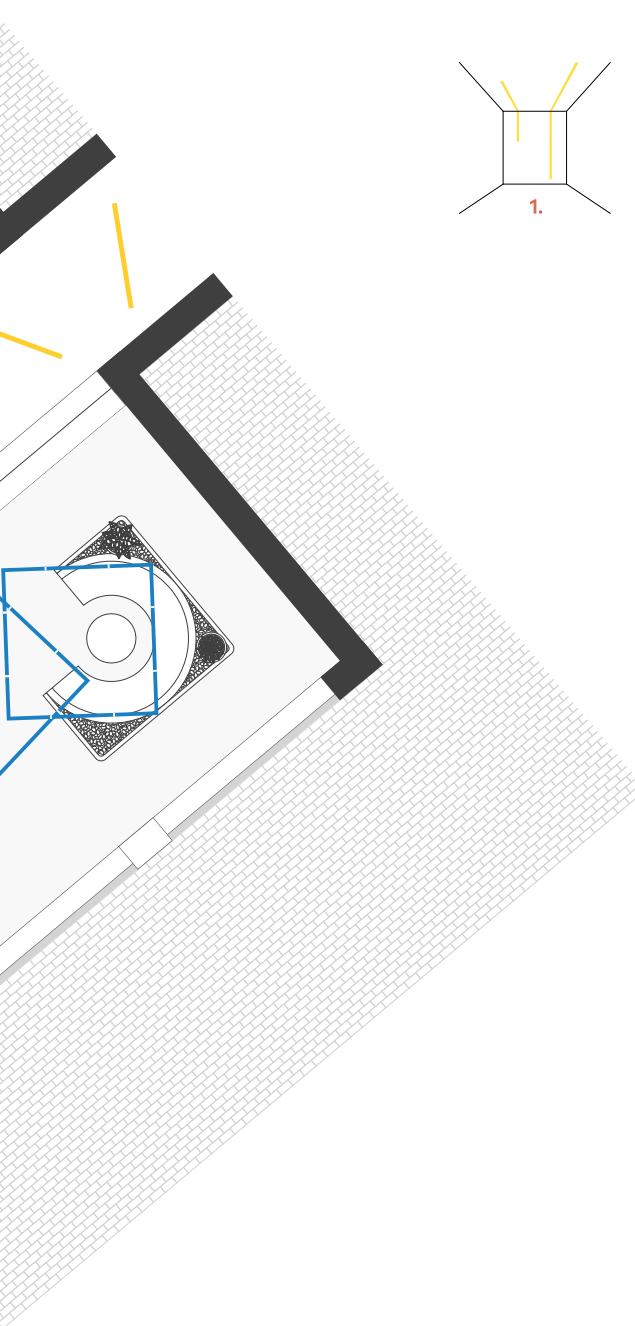
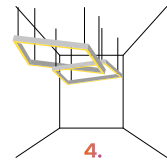
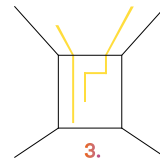
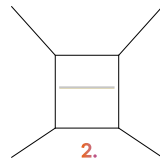
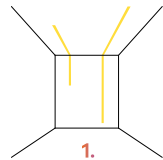

Módulos disponibles

REBA 50

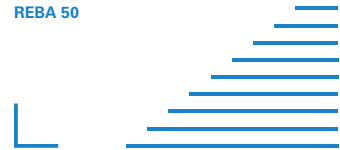

REBA 50 HEXA



REBA 65



Ángulo iluminado

Linear

Escala 1000 mm
1:100



Architects: Gloone
Photo: Antonio Chaves

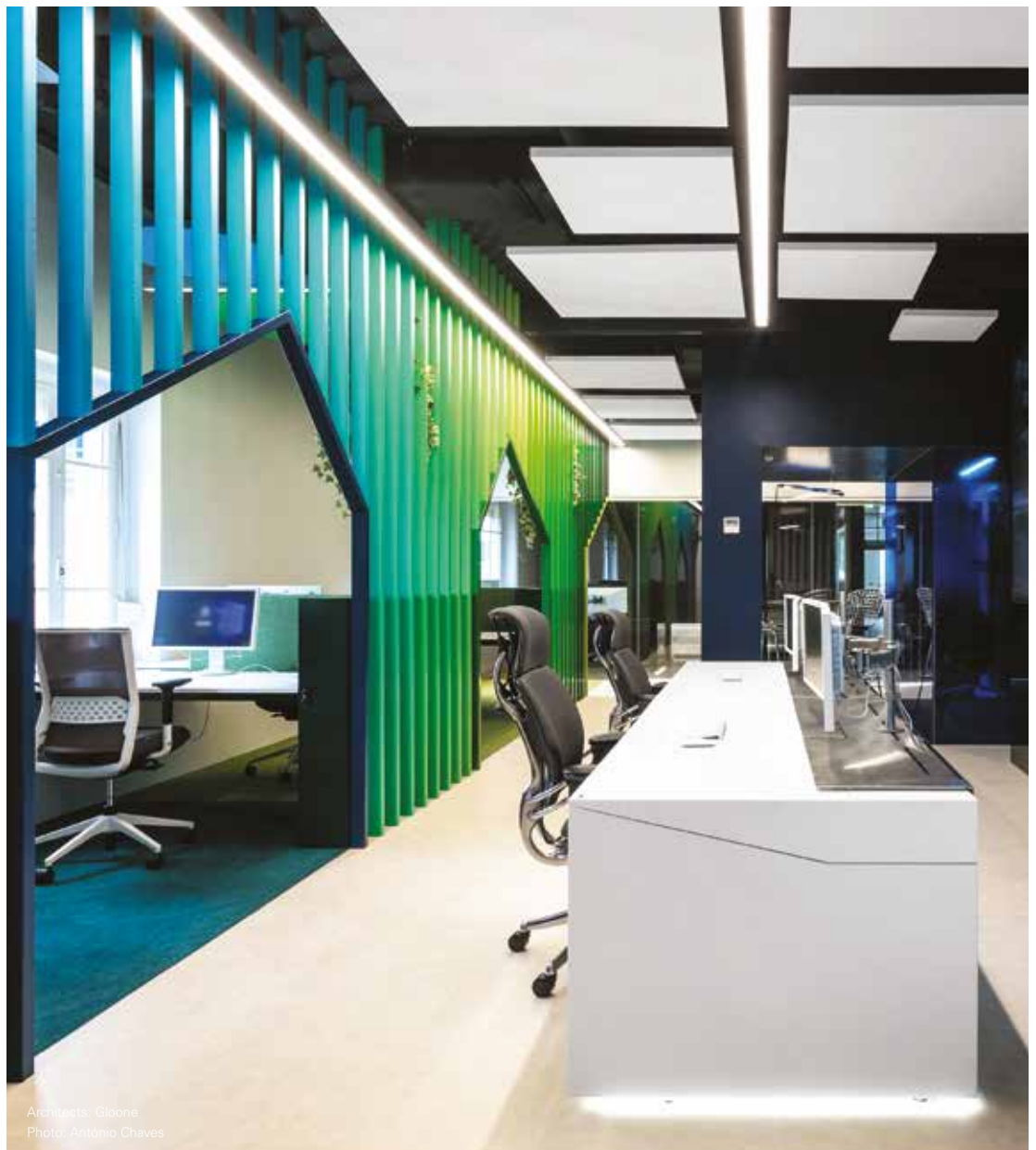

Architects: Gloone
Photo: António Chaves

Minimalismo y tecnología

1. Perfil exterior

Perfil de aluminio extruido, disponible en 3 colores.

2. LED

SDCM MacAdam ≤ 3 , temperatura de color 3000K / 4000K, CRI > 80 y vida útil de 80.000h L90 B10.

3. Tunable White

Versiones Tunable White disponibles con un espectro de blancos de 2700K a 6500K.



4. bGLARE, bLINE o ASYM

Sistema óptico clip-in de alta tecnología con difusor microprismático bGLARE para una iluminación de alto confort visual, difusor opalino bLINE para proporcionar una luz suave y uniforme sin puntos o difusor ASYM para aplicaciones wall wash.

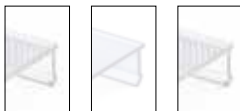

5. Eficiencia superior a 100 lm/W

La gama REBA ofrece una alta eficiencia, con valores superiores a 100 lm/W.

6. Tapas

Tapas sin tornillos visibles y sin salidas de luz. Disponibles en el color del producto.

7. Perfil interior

Reflector interno en perfil de alto rendimiento, acabado en epoxi-poliéster de color blanco para garantizar una luz de alta eficiencia, suave y uniforme. Disponible en versión simétrica o asimétrica (wall wash) con distribución luminosa directa o directa/indirecta. También disponible versión de pared que permite una distribución de luz directa, indirecta o directa / indirecta.

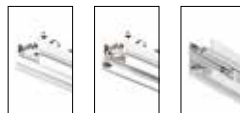

8. Versión directa / indirecta

Versión directa/indirecta con difusor opalino en la parte superior, que garantiza una perfecta uniformidad de la luz en el techo.



9. Fuente de alimentación DALI o HF

10. Suspensión y cable de alimentación

Suspensión y cable de alimentación disponible en longitudes de 1500, 3000 o 6000 mm.



11. Base de techo

Base de techo en versión empotrada o de superficie disponibles en blanco o negro.

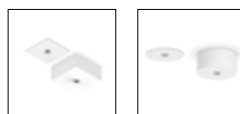

12. Kit de unión

Los dos perfiles están perfectamente conectados para que no existan salidas de luz en cualquier aplicación de línea continua.



13. Kit de emergencia

Kit de emergencia de 3 horas. Disponible desde ≈ 1120 mm hasta ≈ 2800 mm.

14. Doble circuito

Doble circuito que permite controlar la luz directa/indirecta por separado. Disponible como opción.

15. Premarco de montaje trimless

Las versiones sin marco (trimless) son fáciles de instalar en techos de 10, 13, 15 o 18 mm de espesor. Premarco suministrado con el "Kit de alineación del marco". Esta opción permite al instalador mantener el ancho requerido a lo largo de toda la línea, asegurando una perfecta instalación.

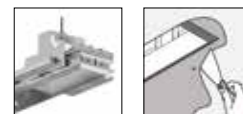

16. Niveladores

Las versiones de empotrar con marco tienen una fácil instalación debido a un soporte de montaje inteligente para instalaciones en techos / paredes de hasta 25 mm de grosor.



17. Ángulos iluminados

La gama REBA dispone de 5 versiones de ángulos iluminados.

- 17.1 Ángulo vertical
- 17.2 Ángulo horizontal
- 17.3 Ángulo iluminado horizontal
- 17.4 Ángulo iluminado de pared horizontal
- 17.5 Ángulo iluminado de pared vertical

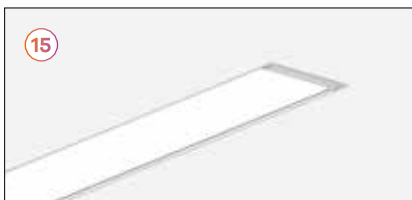
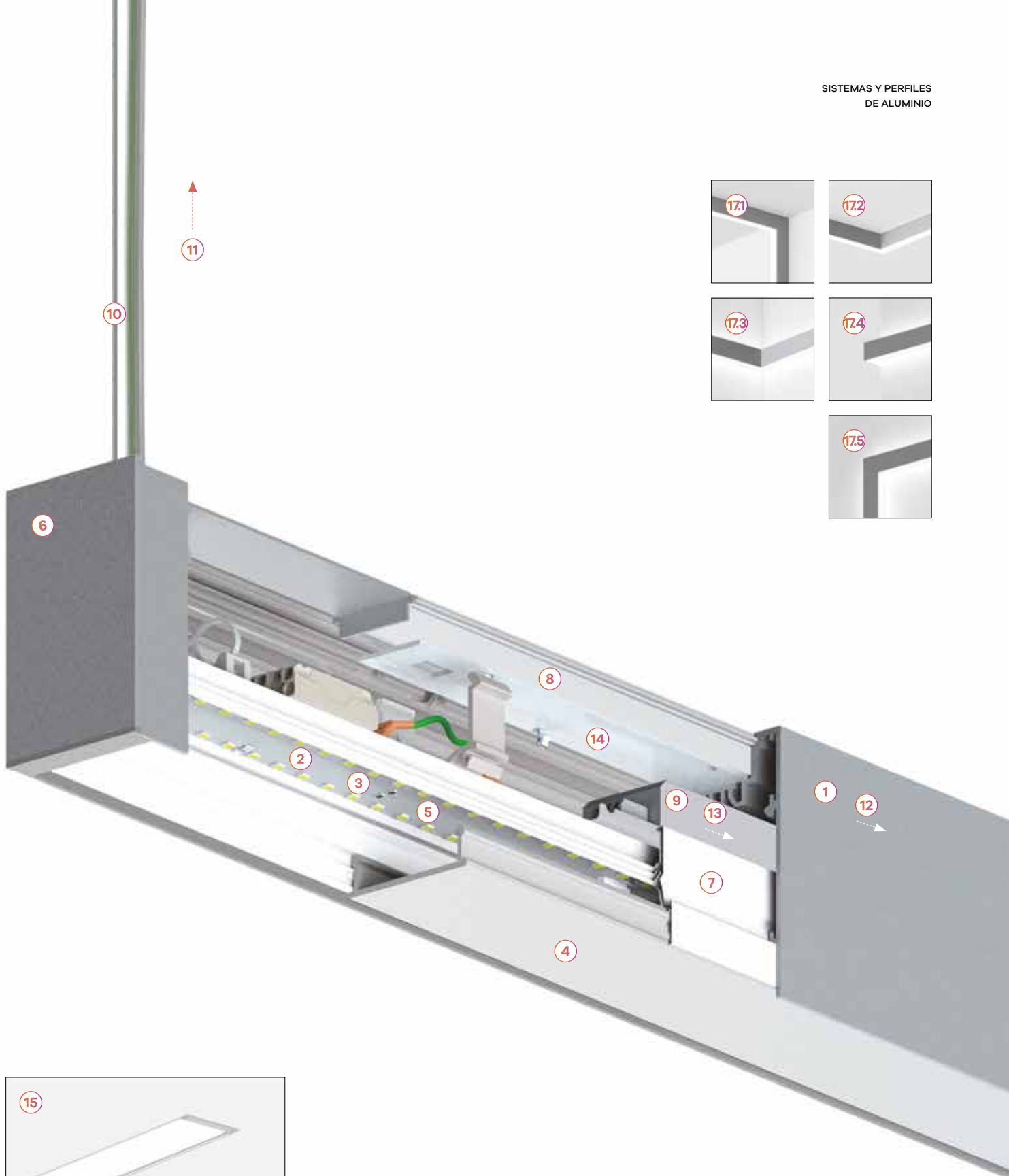

Composición de los elementos estructurales

1. Tapas

2. Perfil exterior

- 2.1 Módulo inicial/final (SRT/END).
- 2.2 Módulo intermedio (MID) o ángulo iluminado (HRZ, VRT, EDGE).

3. Perfil interior

- 3.1 Simétrico
 - 3.2 Asimétrico
- Las dos versiones de perfil interior pueden combinarse en el mismo perfil exterior.

4. Difusores

- 4.1 Difusor bGLARE
- 4.2 Difusor bLINE
- 4.3 Difusor ASYM
- 4.4 Módulo ciego

5. Kit de unión

6. Base de techo

7. Cable de alimentación

8. Suspensión

Módulos disponibles

(Vista desde arriba)

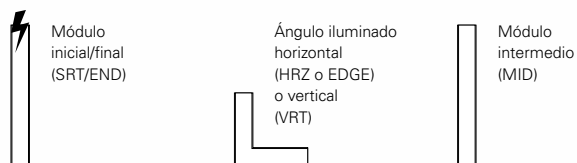

Cómo montar una línea

(Vista desde arriba)



Diagrama de cableado para línea continua (K3)



Diagrama de cableado para línea continua (K3 + Telemando)

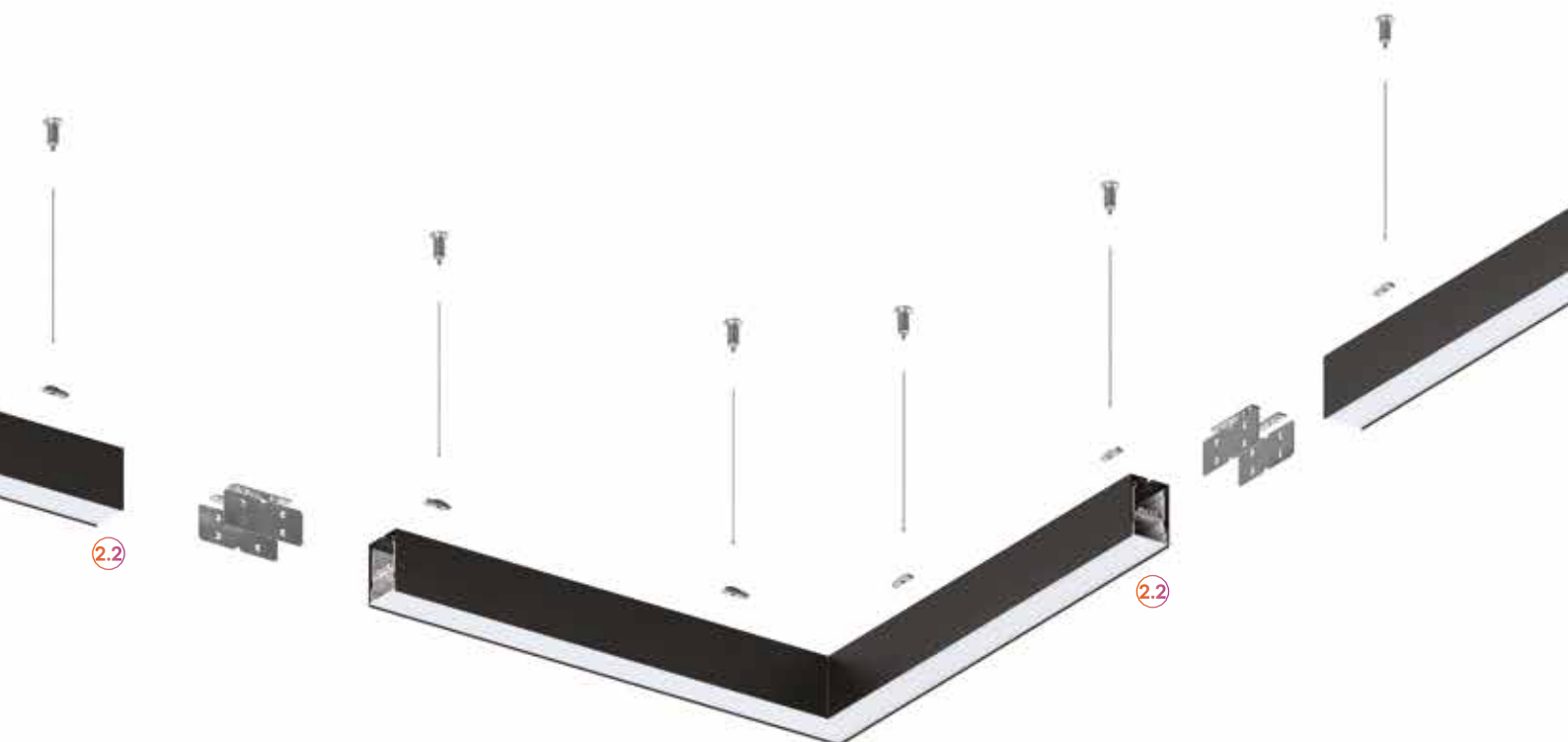
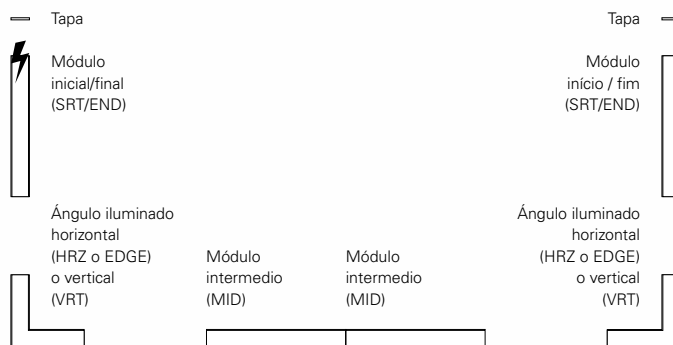

Defina su color

SISTEMAS Y PERFILES
DE ALUMINIO

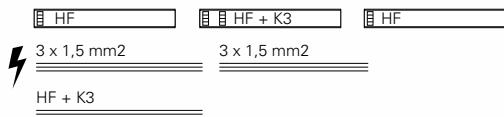
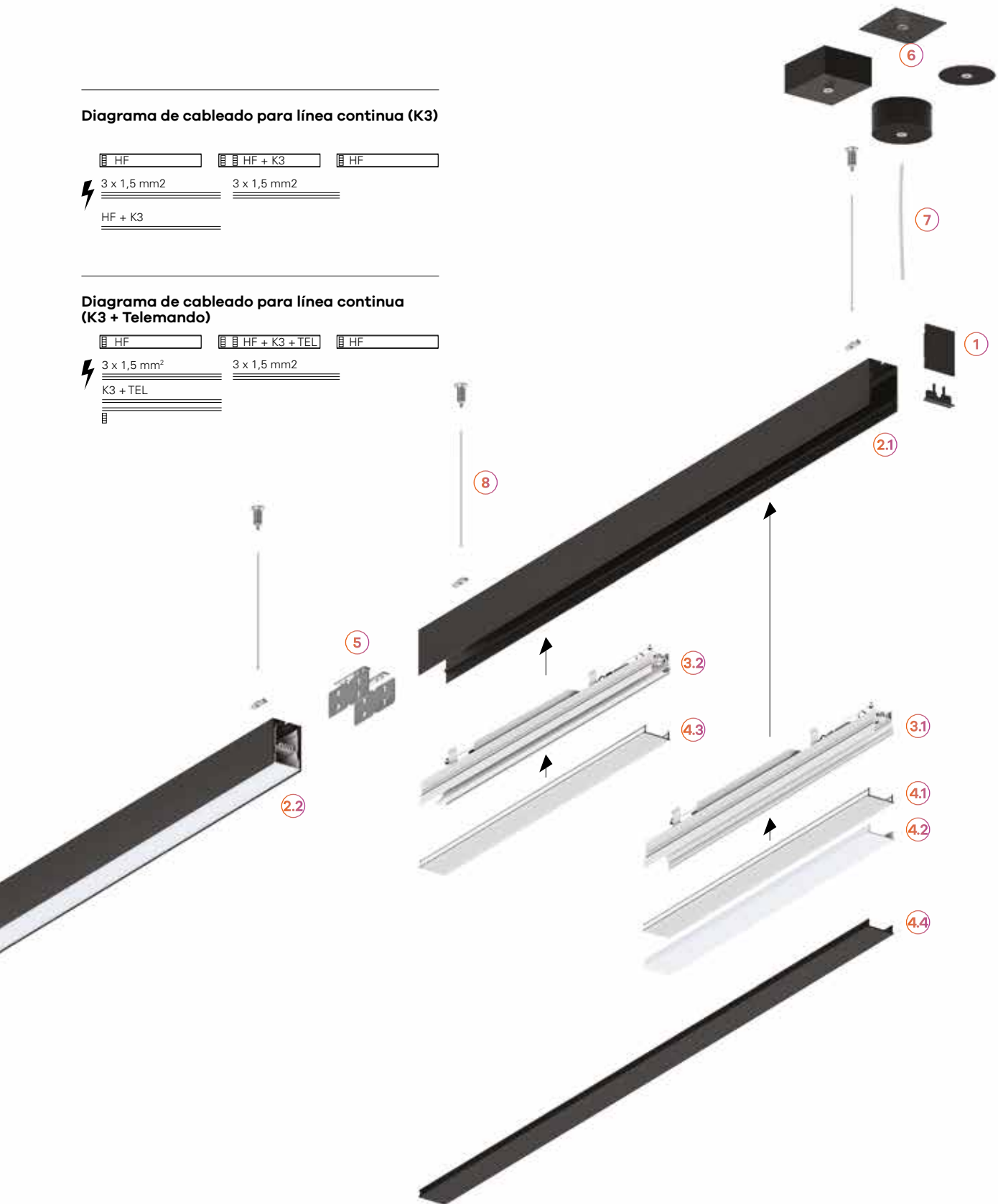
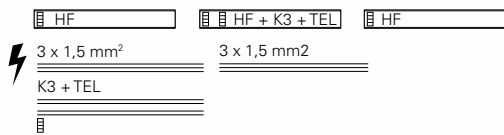

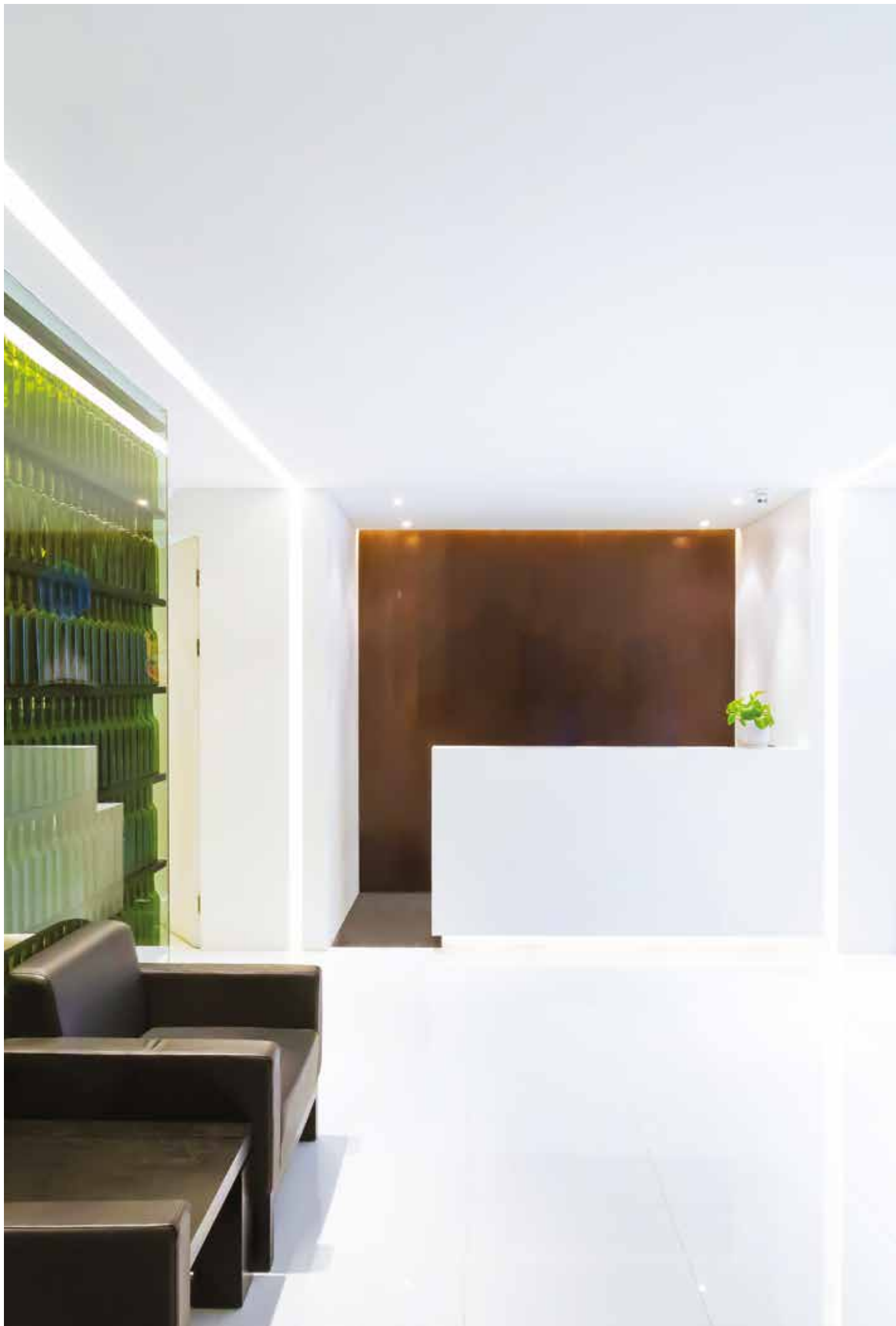

REBA 50

Cómo funciona

1. Perfil exterior

- 1.1 Empotrar
- 1.2 Trimless
- 1.3 Superficie
- 1.4 Suspendida directa
- 1.5 Suspendida directa / indirecta
- 1.6 Pared

2. Perfil interior

- 2.1 Simétrico



- 2.2 Asimétrico



- 2.3 Pared



3. Difusores

- 3.1 Difusor bLINE
 - 3.2 Difusor bGLARE
 - 3.3 Tapa ciega
 - 3.4 Difusor ASYM
-

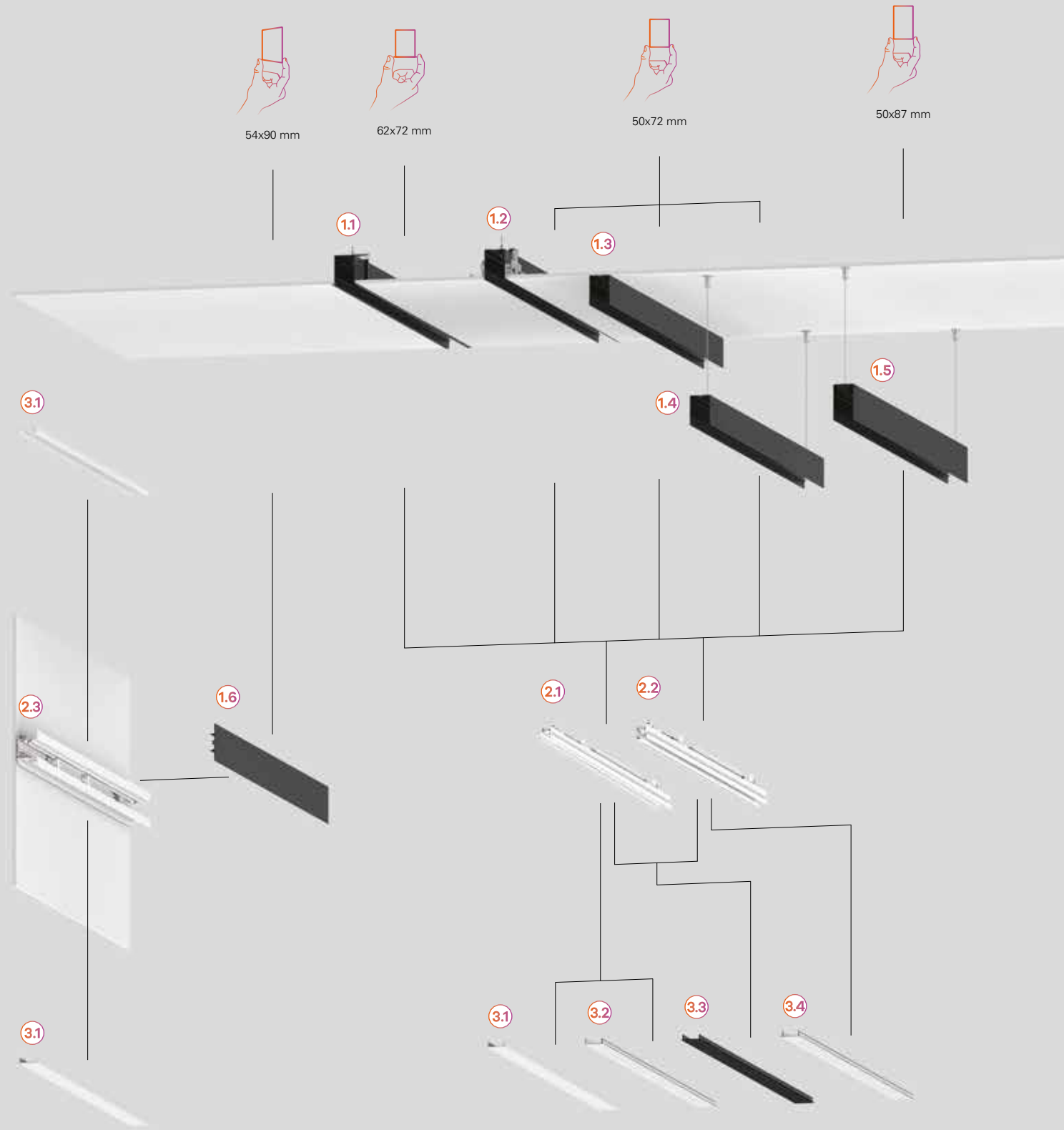

REBA 50 /T



Características del producto

Cuerpo

Perfil de aluminio extruido

Acabado

Pintado en epoxi-poliéster

Sistema de fijación

Premarco trimless (incluido en el perfil exterior)

Sistema óptico

bGLARE - Difusor microprismático

bLINE - Difusor opalino

ASYM - Difusor Asimétrico

Fuente de luz

LED, RG1, CRI>80, MacAdam Step ≤3

Vida útil del LED

80.000h @ L90, B10, Ta 25°C

Fuente de alimentación

Driver LED 220-240V-50/60Hz incluido

Espesor del techo

Para techos de 10, 13, 15 y 18 mm

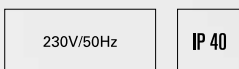

01. Seleccionar perfil exterior

PERFIL EXTERIOR

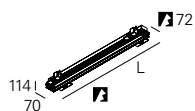

Lmm		CÓDIGO*
598	600	90519L0020▲0000
878	880	90519L0030▲0000
1158	1160	90519L0040▲0000
1438	1440	90519L0050▲0000
1718	1720	90519L0060▲0000
2000	2002	90519L0070▲0000
2280	2282	90519L0080▲0000
2560	2562	90519L0090▲0000
2840	2842	90519L0100▲0000



*Sustituya los símbolos para completar el código

Color	▲
<input type="checkbox"/> Blanco	W
<input type="checkbox"/> Gris	G
<input type="checkbox"/> Negro	B

PERFIL EXTERIOR

• Para completar el producto, es necesario pedir el perfil interior por separado.

02. Seleccionar perfil interior y difusor

PERFIL INTERIOR | SIMÉTRICO

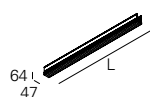

bGLARE - Difusor microprismático

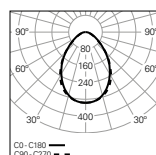

W	lm output	lm/W	Lmm	CÓDIGO*
15	1603	107	562	90498L002▼W0◆00
22	2405	109	842	90498L003▼W0◆00
30	3207	107	1122	90498L004▼W◆000
35	4008	115	1402	90498L005▼W◆000
42	4810	115	1682	90498L006▼W◆000
52	5612	108	1964	90498L007▼W◆000
60	6413	107	2244	90498L008▼W◆000
65	7215	111	2524	90498L009▼W◆000
70	8017	115	2804	90498L010▼W◆000

*Sustituya los símbolos para completar el código

Fuente de alimentación	▼
HF	E
DALI	H

Emergencia	●
No EM	0
EM 3h (K3) ^{1 2}	3

Temp. de color	◆
3000K	3
4000K	0
Tunable White ³	T

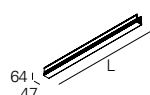

bLINE - Difusor opalino

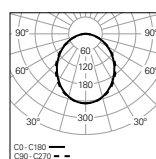

W	lm output	lm/W	Lmm	CÓDIGO*
15	1655	110	562	90497L002▼W0◆00
22	2483	113	842	90497L003▼W0◆00
30	3310	110	1122	90497L004▼W◆000
35	4138	118	1402	90497L005▼W◆000
42	4965	118	1682	90497L006▼W◆000
52	5793	111	1964	90497L007▼W◆000
60	6620	110	2244	90497L008▼W◆000
65	7448	115	2524	90497L009▼W◆000
70	8275	118	2804	90497L010▼W◆000

PERFIL INTERIOR | ASIMÉTRICO

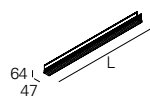

ASYM - Difusor

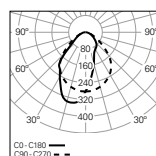

W	lm output	lm/W	Lmm	CÓDIGO*
16	1396	87	562	90500L002▼W0◆00
23	2095	91	842	90500L003▼W0◆00
29	2793	96	1122	90500L004▼W◆000
36	3491	97	1402	90500L005▼W◆000
44	4189	95	1682	90500L006▼W◆000
52	4888	94	1964	90500L007▼W◆000
58	5586	96	2244	90500L008▼W◆000
65	6284	97	2524	90500L009▼W◆000
73	6982	96	2804	90500L010▼W◆000

¹ Preparado para telemando.

² Versiones DALI + EM 3h (K3) sólo disponibles a partir de L1402 mm.

³ Sólo disponible en versiones DALI sin kit de emergencia (No EM). No disponible en la versión L562 mm.

03. Seleccionar opciones

OPCIONES	Código
SwitchDIM Tunable White • Para $L \leq 1682$ mm permite controlar un máximo de 20 luminarias, $L \geq 1964$ mm permite controlar un máximo de 10 luminarias por cada SwitchDIM Tunable White.	926600
Cable de seguridad en acero L1500 mm	955000
Versión low output • Mediante solicitud.	



Detalles del producto



Perfil exterior



Perfil interno simétrico



Perfil interior asimétrico



Uniformidad de la luz



Premarco trimless



Difusor clip-in

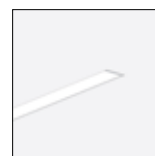

Aplicación trimless



Difusor bGLARE



Difusor bLINE



Difusor ASYM



SwitchDIM Tunable White



REBA 50 /T Line

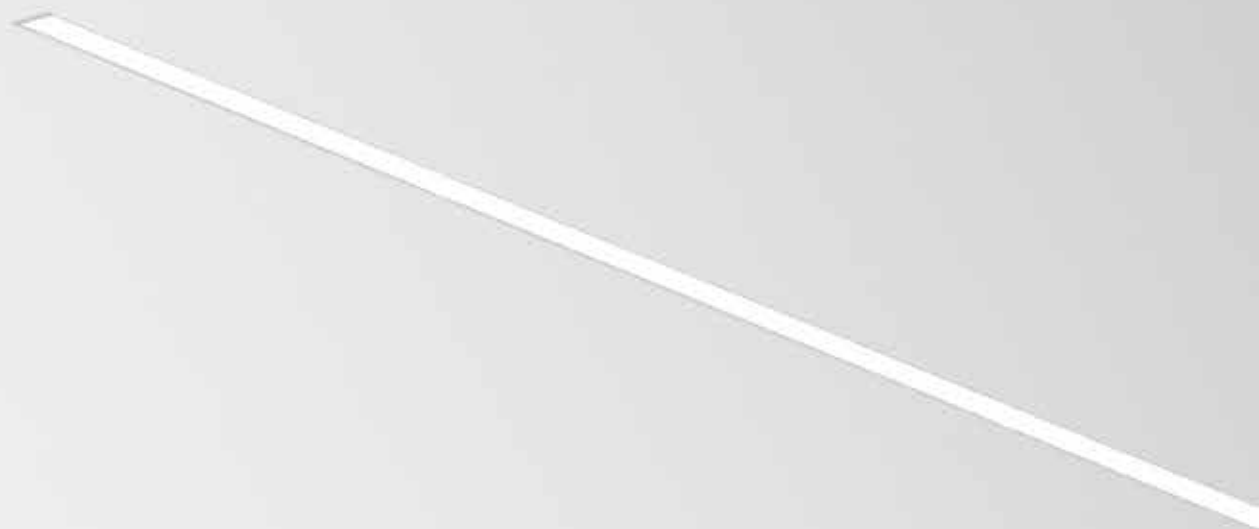

Características del producto

Cuerpo

Perfil de aluminio extruido

Acabado

Pintado en epoxi-poliéster

Sistema de fijación

Premarco trimless (incluido en el perfil exterior)

Sistema óptico

bGLARE - Difusor microprismático

bLINE - Difusor opalino

ASYM - Difusor Asimétrico

Fuente de luz

LED, RG1, CRI>80, MacAdam Step ≤3

Vida útil del LED

80.000h @ L90, B10, Ta 25°C

Fuente de alimentación

Driver LED 220-240V-50/60Hz incluido

Espesor del techo

Para techos de 10, 13, 15 y 18 mm

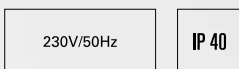

01. Seleccionar perfil exterior



PERFIL EXTERIOR

Inicial / Final (SRT/END)

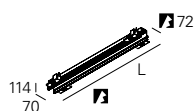

Lmm	72	CÓDIGO*
580	581	90507L0020▲0083
860	861	90507L0030▲0083
1140	1141	90507L0040▲0083
1420	1421	90507L0050▲0083
1700	1701	90507L0060▲0083
1982	1983	90507L0070▲0083
2262	2263	90507L0080▲0083
2542	2543	90507L0090▲0083
2822	2823	90507L0100▲0083

*Sustituya los símbolos para completar el código

Color	▲
□ Blanco	W
■ Gris	G
■ Negro	B

Intermedio (MID)

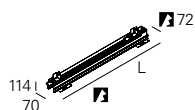

Lmm	72	CÓDIGO*
562	562	90507L0020▲0000
842	842	90507L0030▲0000
1122	1122	90507L0040▲0000
1402	1402	90507L0050▲0000
1682	1682	90507L0060▲0000
1964	1964	90507L0070▲0000
2244	2244	90507L0080▲0000
2524	2524	90507L0090▲0000
2804	2804	90507L0100▲0000

Ángulo vertical (VRT)

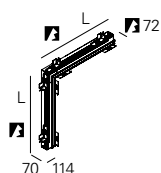

Lmm	72	CÓDIGO*
569	534	90507V0040▲0000

Ángulo horizontal (HRZ) - Ángulo horizontal (EDGE)

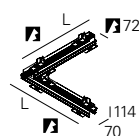

Lmm	72	CÓDIGO*
611	612	90507H0040▲0000

PERFIL EXTERIOR

- Para completar el producto, es necesario pedir el perfil interior por separado.
- Para completar una línea, es necesario un Start Kit, cableado de línea continua y kit de unión. Por favor solicítelo por separado.
- La longitud máxima de línea con un solo punto de alimentación es de 30000 mm.

02. Seleccionar perfil interior y difusor



PERFIL INTERIOR | SIMÉTRICO

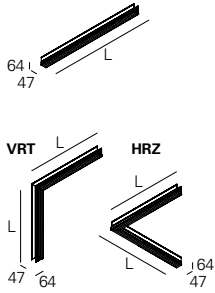

bGLARE - Difusor microprismático

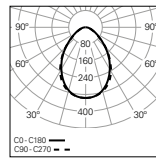

W	lm output	lm/W	Lmm	CÓDIGO*	
15	1603	107	562	90498L002♥W0♦00	
22	2405	109	842	90498L003♥W0♦00	
30	3207	107	1122	90498L004♥W♦♦00	
35	4008	115	1402	90498L005♥W♦♦00	
42	4810	115	1682	90498L006♥W♦♦00	
52	5612	108	1964	90498L007♥W♦♦00	
60	6413	107	2244	90498L008♥W♦♦00	
65	7215	111	2524	90498L009♥W♦♦00	
70	8017	115	2804	90498L010♥W♦♦00	
VRT	30	3207	107	599	90498V004♥W0♦00
HRZ	30	3207	107	577	90498H004♥W0♦00

bLINE - Difusor opalino

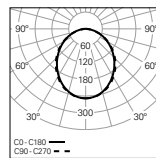

W	lm output	lm/W	Lmm	CÓDIGO*	
15	1655	110	562	90497L002♥W0♦00	
22	2483	113	842	90497L003♥W0♦00	
30	3310	110	1122	90497L004♥W♦♦00	
35	4138	118	1402	90497L005♥W♦♦00	
42	4965	118	1682	90497L006♥W♦♦00	
52	5793	111	1964	90497L007♥W♦♦00	
60	6620	110	2244	90497L008♥W♦♦00	
65	7448	115	2524	90497L009♥W♦♦00	
70	8275	118	2804	90497L010♥W♦♦00	
VRT	30	3310	110	599	90497V004♥W0♦00
HRZ	30	3310	110	577	90497H004♥W0♦00

PERFIL INTERIOR | ASIMÉTRICO

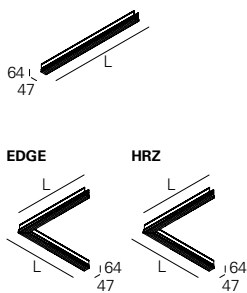

ASYM - Difusor

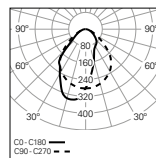

W	lm output	lm/W	Lmm	CÓDIGO*	
16	1396	87	562	90500L002♥W0♦00	
23	2095	91	842	90500L003♥W0♦00	
29	2793	96	1122	90500L004♥W♦♦00	
36	3491	97	1402	90500L005♥W♦♦00	
44	4189	95	1682	90500L006♥W♦♦00	
52	4888	94	1964	90500L007♥W♦♦00	
58	5586	96	2244	90500L008♥W♦♦00	
65	6284	97	2524	90500L009♥W♦♦00	
73	6982	96	2804	90500L010♥W♦♦00	
EDGE	29	2793	96	599	90500E004♥W0♦00
HRZ	29	2793	96	577	90500H004♥W0♦00

*Sustituya los símbolos para completar el código

Fuente de alimentación ♥
HF E
DALI H

Emergencia ●
No EM 0
EM 3h (K3) ^{1 2} 3

Temp. de color ♦
3000K 3
4000K 0
Tunable White ³ T

¹ Preparado para telemando.

² Versiones DALI + EM 3h (K3) sólo disponibles a partir de L1402 mm.

³ Sólo disponible en versiones DALI sin kit de emergencia (No EM). No disponible en la versión L562 mm.

03. Seleccionar opciones

OPCIONES	Código*
SwitchDIM Tunable White • Para L ≤ 1682 mm permite controlar un máximo de 20 luminarias, L ≥ 1964 mm permite controlar un máximo de 10 luminarias por cada SwitchDIM Tunable White.	926600
Start kit - Tapas inicio/final • Dos tapas finales incluidas.	72 50 3 923100♣
Cableado de línea continua • Estándar 3 x 1,5 mm ² 5 x 1,5 mm ²	945650 945750
• 2 x 1,5 mm² HF+K3 (x1) - L562 - L1682 mm HF+K3 (x2) - L1964 - L2804 mm	948000 948001
• 2 x 1,5 mm² + Borna de conexión 5P DALI+K3 (x1) - L562 - L1682 mm DALI+K3 (x2) - L1964 - L2804 mm	948200 948201
• 2 x 1,5 mm² + 2 x 0,75 mm² + Borna de conexión 5P K3+TEL (x1) - L562 - L1682 mm K3+TEL (x2) - L1964 - L2804 mm	948100 948101
Kit de unión • Unión galvanizada, tornillos incluidos.	932130
Módulo ciego L1500 mm L3000 mm • Incluye perfil interior vacío y tapa ciega de aluminio.	992980♣ 992981♣
Cable de seguridad en acero L1500 mm	955000
Versión low output • Mediante solicitud.	
Proyectos a medida • Mediante solicitud.	



*Sustituya los símbolos para completar el código

Color	♣
□ Blanco	W
■ Gris	G
■ Negro	B



Detalles del producto



Perfil exterior



Perfil interno simétrico



Perfil interior asimétrico



Uniformidad de la luz

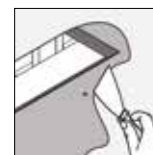

Premarco trimless



Difusor clip-in



Ángulo vertical



Ángulo horizontal



Aplicação trimless



Difusor bGLARE



Difusor bLINE



Difusor ASYM



SwitchDIM Tunable White



Start kit

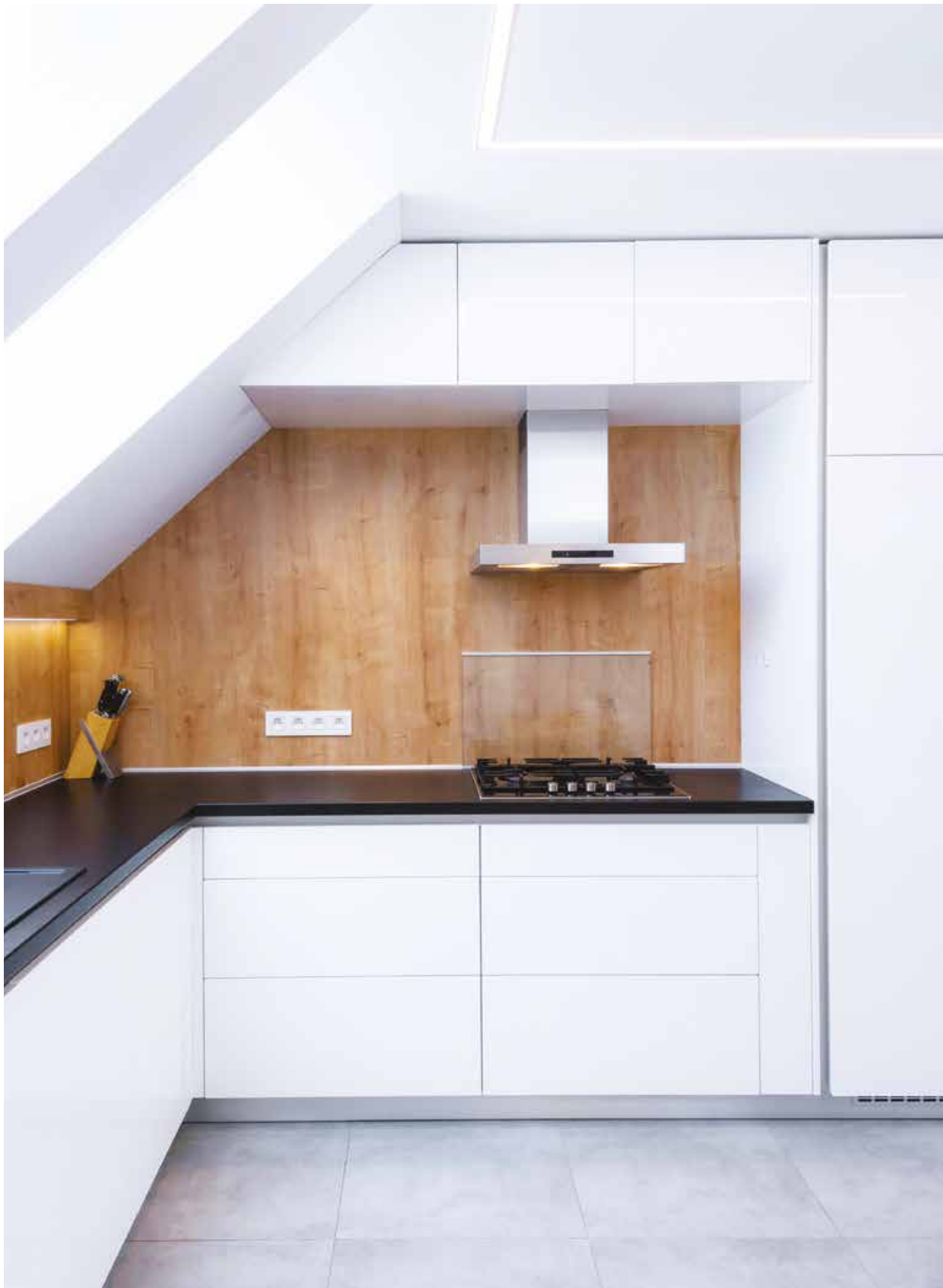

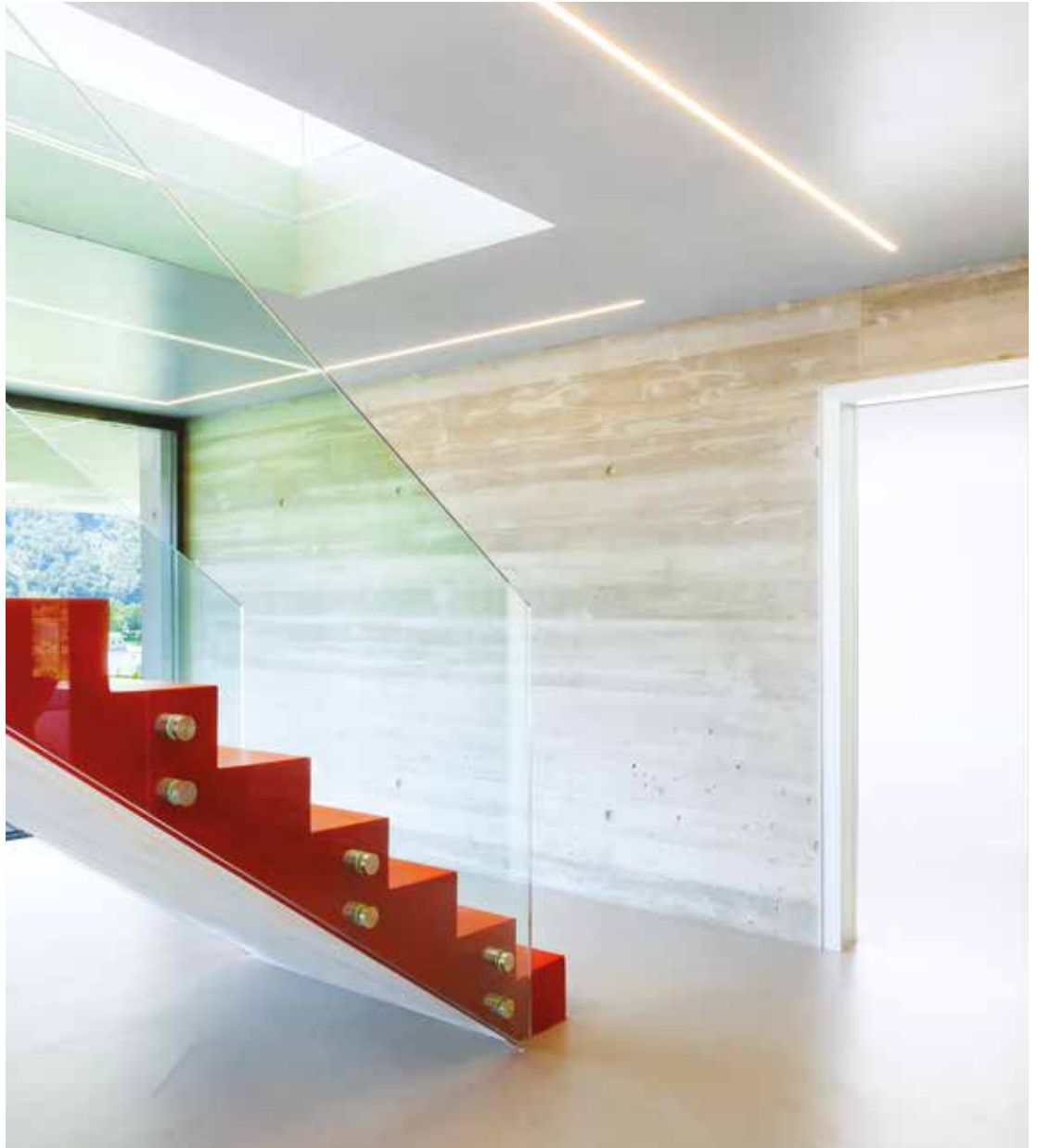

REBA 50 /E



Características del producto

Cuerpo

Perfil de aluminio extruido

Acabado

Pintado en epoxi-poliéster

Sistema de fijación

Niveladores

Sistema óptico

bGLARE - Difusor microprismático

bLINE - Difusor opalino

ASYM - Difusor Asimétrico

Fuente de luz

LED, RG1, CRI>80, MacAdam Step ≤ 3

Vida útil del LED

80.000h @ L90, B10, Ta 25°C

Fuente de alimentación

Driver LED 220-240V-50/60Hz incluido

Espesor del techo

Para techos entre 1-25 mm

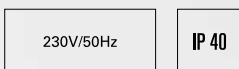

01. Seleccionar perfil exterior

PERFIL EXTERIOR

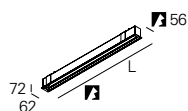

Lmm		CÓDIGO*
590	580	90520L0020▲0000
870	860	90520L0030▲0000
1150	1140	90520L0040▲0000
1430	1420	90520L0050▲0000
1710	1700	90520L0060▲0000
1992	1982	90520L0070▲0000
2272	2262	90520L0080▲0000
2552	2542	90520L0090▲0000
2832	2822	90520L0100▲0000



*Sustituya los símbolos para completar el código

Color	▲
□ Blanco	W
■ Gris	G
■ Negro	B

PERFIL EXTERIOR

• Para completar el producto, es necesario pedir el perfil interior por separado.

02. Seleccionar perfil interior y difusor

PERFIL INTERIOR | SIMÉTRICO

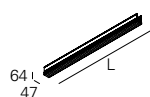

bGLARE - Difusor microprismático

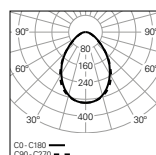

W	lm output	lm/W	Lmm	CÓDIGO*
15	1603	107	562	90498L002▼W0◆00
22	2405	109	842	90498L003▼W0◆00
30	3207	107	1122	90498L004▼W◆000
35	4008	115	1402	90498L005▼W◆000
42	4810	115	1682	90498L006▼W◆000
52	5612	108	1964	90498L007▼W◆000
60	6413	107	2244	90498L008▼W◆000
65	7215	111	2524	90498L009▼W◆000
70	8017	115	2804	90498L010▼W◆000

*Sustituya los símbolos para completar el código

Fuente de alimentación	▼
HF	E
DALI	H

Emergencia	●
No EM	0
EM 3h (K3) ^{1 2}	3

Temp. de color	◆
3000K	3
4000K	0
Tunable White ³	T

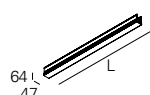

bLINE - Difusor opalino

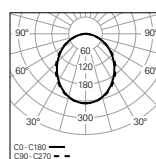

W	lm output	lm/W	Lmm	CÓDIGO*
15	1655	110	562	90497L002▼W0◆00
22	2483	113	842	90497L003▼W0◆00
30	3310	110	1122	90497L004▼W◆000
35	4138	118	1402	90497L005▼W◆000
42	4965	118	1682	90497L006▼W◆000
52	5793	111	1964	90497L007▼W◆000
60	6620	110	2244	90497L008▼W◆000
65	7448	115	2524	90497L009▼W◆000
70	8275	118	2804	90497L010▼W◆000

PERFIL INTERIOR | ASIMÉTRICO

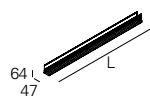

ASYM - Difusor

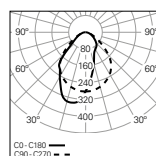

W	lm output	lm/W	Lmm	CÓDIGO*
16	1396	87	562	90500L002▼W0◆00
23	2095	91	842	90500L003▼W0◆00
29	2793	96	1122	90500L004▼W◆000
36	3491	97	1402	90500L005▼W◆000
44	4189	95	1682	90500L006▼W◆000
52	4888	94	1964	90500L007▼W◆000
58	5586	96	2244	90500L008▼W◆000
65	6284	97	2524	90500L009▼W◆000
73	6982	96	2804	90500L010▼W◆000

¹ Preparado para telemando.

² Versiones DALI + EM 3h (K3) sólo disponibles a partir de L1402 mm.

³ Sólo disponible en versiones DALI sin kit de emergencia (No EM). No disponible en la versión L562 mm.

03. Seleccionar opciones

OPCIONES	Código
SwitchDIM Tunable White • Para $L \leq 1682$ mm permite controlar un máximo de 20 luminarias, $L \geq 1964$ mm permite controlar un máximo de 10 luminarias por cada SwitchDIM Tunable White.	926600
Cable de seguridad en acero L1500 mm	955000
Versión low output • Mediante solicitud.	



Detalles del producto



Perfil exterior



Nivelador



Perfil interno simétrico



Perfil interior asimétrico



Uniformidad de la luz



Difusor clip-in



Aplicación de empotrar



Difusor bGLARE



Difusor bLINE



Difusor ASYM



SwitchDIM
Tunable White



REBA 50 /E Line

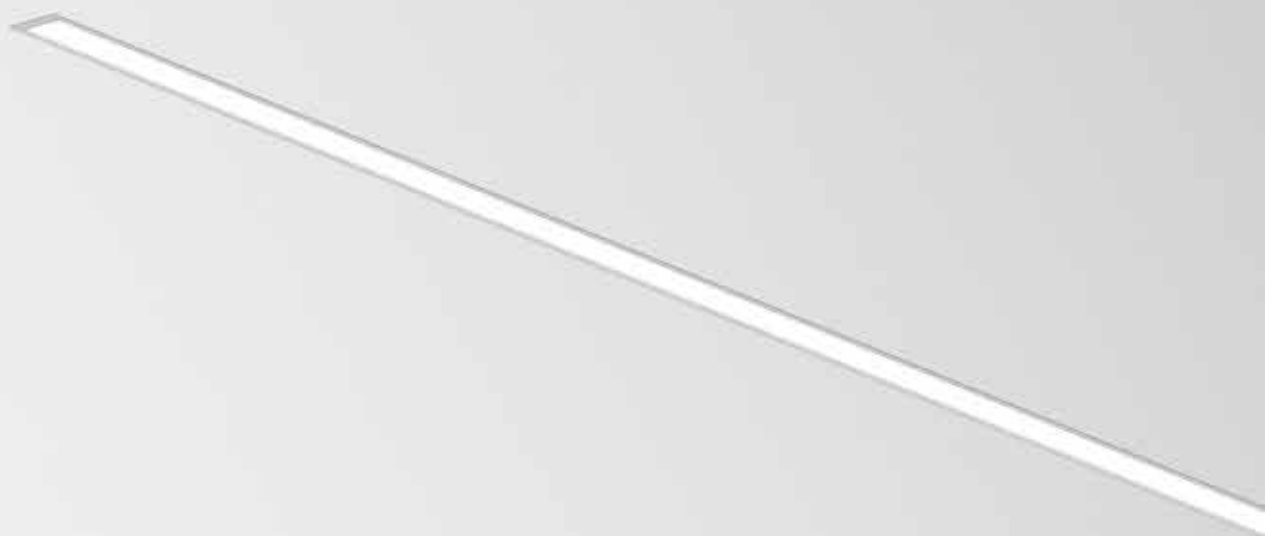

Características del producto

Cuerpo

Perfil de aluminio extruido

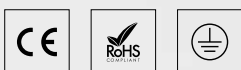

Acabado

Pintado en epoxi-poliéster

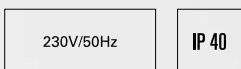

Sistema de fijación

Niveladores



Sistema óptico

bGLARE - Difusor microprismático

bLINE - Difusor opalino

ASYM - Difusor Asimétrico



Fuente de luz

LED, RG1, CRI>80, MacAdam Step ≤3

Vida útil del LED

80.000h @ L90, B10, Ta 25°C

Fuente de alimentación

Driver LED 220-240V-50/60Hz incluido

Espesor del techo

Para techos entre 1-25 mm

01. Seleccionar perfil exterior



PERFIL EXTERIOR

Inicial / Final (SRT/END)

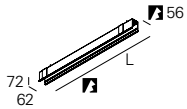

Lmm	56	CÓDIGO*
567	568	90506L0020▲0083
847	848	90506L0030▲0083
1127	1128	90506L0040▲0083
1407	1408	90506L0050▲0083
1687	1688	90506L0060▲0083
1969	1970	90506L0070▲0083
2249	2250	90506L0080▲0083
2529	2530	90506L0090▲0083
2809	2810	90506L0100▲0083

*Sustituya los símbolos para completar el código

Color	▲
□ Blanco	W
■ Gris	G
■ Negro	B

Intermedio (MID)

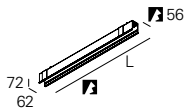

Lmm	56	CÓDIGO*
562	562	90506L0020▲0000
842	842	90506L0030▲0000
1122	1122	90506L0040▲0000
1402	1402	90506L0050▲0000
1682	1682	90506L0060▲0000
1964	1964	90506L0070▲0000
2244	2244	90506L0080▲0000
2524	2524	90506L0090▲0000
2804	2804	90506L0100▲0000

Ángulo vertical (VRT)

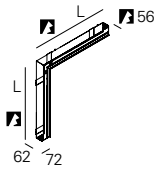

Lmm	56	CÓDIGO*
606	536	90506V0040▲0000

Ángulo horizontal (HRZ) - Ángulo horizontal (EDGE)

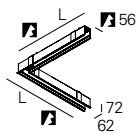

Lmm	56	CÓDIGO*
607	604	90506H0040▲0000

PERFIL EXTERIOR

- Para completar el producto, es necesario pedir el perfil interior por separado.
- Para completar una línea, es necesario un Start Kit, cableado de línea continua y kit de unión. Por favor solicítelo por separado.
- Las dimensiones no incluyen Start Kit. Para completar la dimensión empotrada de la línea, incremente 6 mm a la longitud de corte.
- La longitud máxima de línea con un solo punto de alimentación es de 30000 mm.

02. Seleccionar perfil interior y difusor



PERFIL INTERIOR | SIMÉTRICO

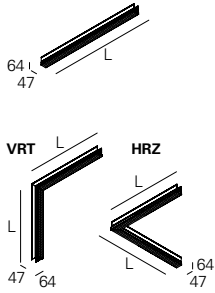

bGLARE - Difusor microprismático

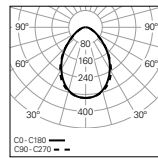

W	lm output	lm/W	Lmm	CÓDIGO*	
15	1603	107	562	90498L002♥W0♦00	
22	2405	109	842	90498L003♥W0♦00	
30	3207	107	1122	90498L004♥W♦♦00	
35	4008	115	1402	90498L005♥W♦♦00	
42	4810	115	1682	90498L006♥W♦♦00	
52	5612	108	1964	90498L007♥W♦♦00	
60	6413	107	2244	90498L008♥W♦♦00	
65	7215	111	2524	90498L009♥W♦♦00	
70	8017	115	2804	90498L010♥W♦♦00	
VRT	30	3207	107	599	90498V004♥W0♦00
HRZ	30	3207	107	577	90498H004♥W0♦00

bLINE - Difusor opalino

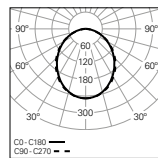

W	lm output	lm/W	Lmm	CÓDIGO*	
15	1655	110	562	90497L002♥W0♦00	
22	2483	113	842	90497L003♥W0♦00	
30	3310	110	1122	90497L004♥W♦♦00	
35	4138	118	1402	90497L005♥W♦♦00	
42	4965	118	1682	90497L006♥W♦♦00	
52	5793	111	1964	90497L007♥W♦♦00	
60	6620	110	2244	90497L008♥W♦♦00	
65	7448	115	2524	90497L009♥W♦♦00	
70	8275	118	2804	90497L010♥W♦♦00	
VRT	30	3310	110	599	90497V004♥W0♦00
HRZ	30	3310	110	577	90497H004♥W0♦00

PERFIL INTERIOR | ASIMÉTRICO

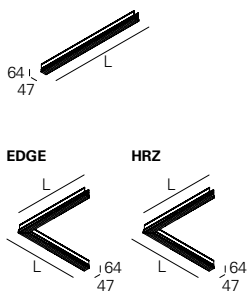

ASYM - Difusor

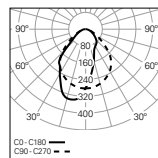

W	lm output	lm/W	Lmm	CÓDIGO*	
16	1396	87	562	90500L002♥W0♦00	
23	2095	91	842	90500L003♥W0♦00	
29	2793	96	1122	90500L004♥W♦♦00	
36	3491	97	1402	90500L005♥W♦♦00	
44	4189	95	1682	90500L006♥W♦♦00	
52	4888	94	1964	90500L007♥W♦♦00	
58	5586	96	2244	90500L008♥W♦♦00	
65	6284	97	2524	90500L009♥W♦♦00	
73	6982	96	2804	90500L010♥W♦♦00	
EDGE	29	2793	96	599	90500E004♥W0♦00
HRZ	29	2793	96	577	90500H004♥W0♦00

*Sustituya los símbolos para completar el código

Fuente de alimentación ♥
HF E
DALI H

Emergencia ●
No EM 0
EM 3h (K3) ^{1 2} 3

Temp. de color ♦
3000K 3
4000K 0
Tunable White ³ T

¹ Preparado para telemando.

² Versiones DALI + EM 3h (K3) sólo disponibles a partir de L1402 mm.

³ Sólo disponible en versiones DALI sin kit de emergencia (No EM). No disponible en la versión L562 mm.

03. Seleccionar opciones

OPCIONES	Código*
SwitchDIM Tunable White • Para L ≤ 1682 mm permite controlar un máximo de 20 luminarias, L ≥ 1964 mm permite controlar un máximo de 10 luminarias por cada SwitchDIM Tunable White.	926600
Start kit - Tapas inicio/final • Dos tapas finales incluidas.	72 923200♣ 62 9
Cableado de línea continua • Estándar 3 x 1,5 mm ² 5 x 1,5 mm ²	945650 945750
• 2 x 1,5 mm² HF+K3 (x1) - L562 - L1682 mm HF+K3 (x2) - L1964 - L2804 mm	948000 948001
• 2 x 1,5 mm² + Borna de conexión 5P DALI+K3 (x1) - L562 - L1682 mm DALI+K3 (x2) - L1964 - L2804 mm	948200 948201
• 2 x 1,5 mm² + 2 x 0,75 mm² + Borna de conexión 5P K3+TEL (x1) - L562 - L1682 mm K3+TEL (x2) - L1964 - L2804 mm	948100 948101
Kit de unión • Unión galvanizada, tornillos incluidos.	932100
Módulo ciego L1500 mm L3000 mm • Incluye perfil interior vacío y tapa ciega de aluminio.	992920♣ 992921♣
Cable de seguridad en acero L1500 mm	955000
Versión low output • Mediante solicitud.	
Proyectos a medida • Mediante solicitud.	



*Sustituya los símbolos para completar el código

Color	♣
□ Blanco	W
■ Gris	G
■ Negro	B



Detalles del producto



Perfil exterior



Perfil interno simétrico



Perfil interior asimétrico



Uniformidad de la luz



Nivelador



Difusor clip-in



Ángulo vertical

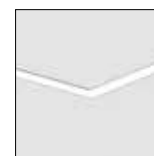

Ángulo horizontal



Aplicación de empotrar



Difusor bGLARE



Difusor bLINE



Difusor ASYM



SwitchDIM Tunable White



Start kit



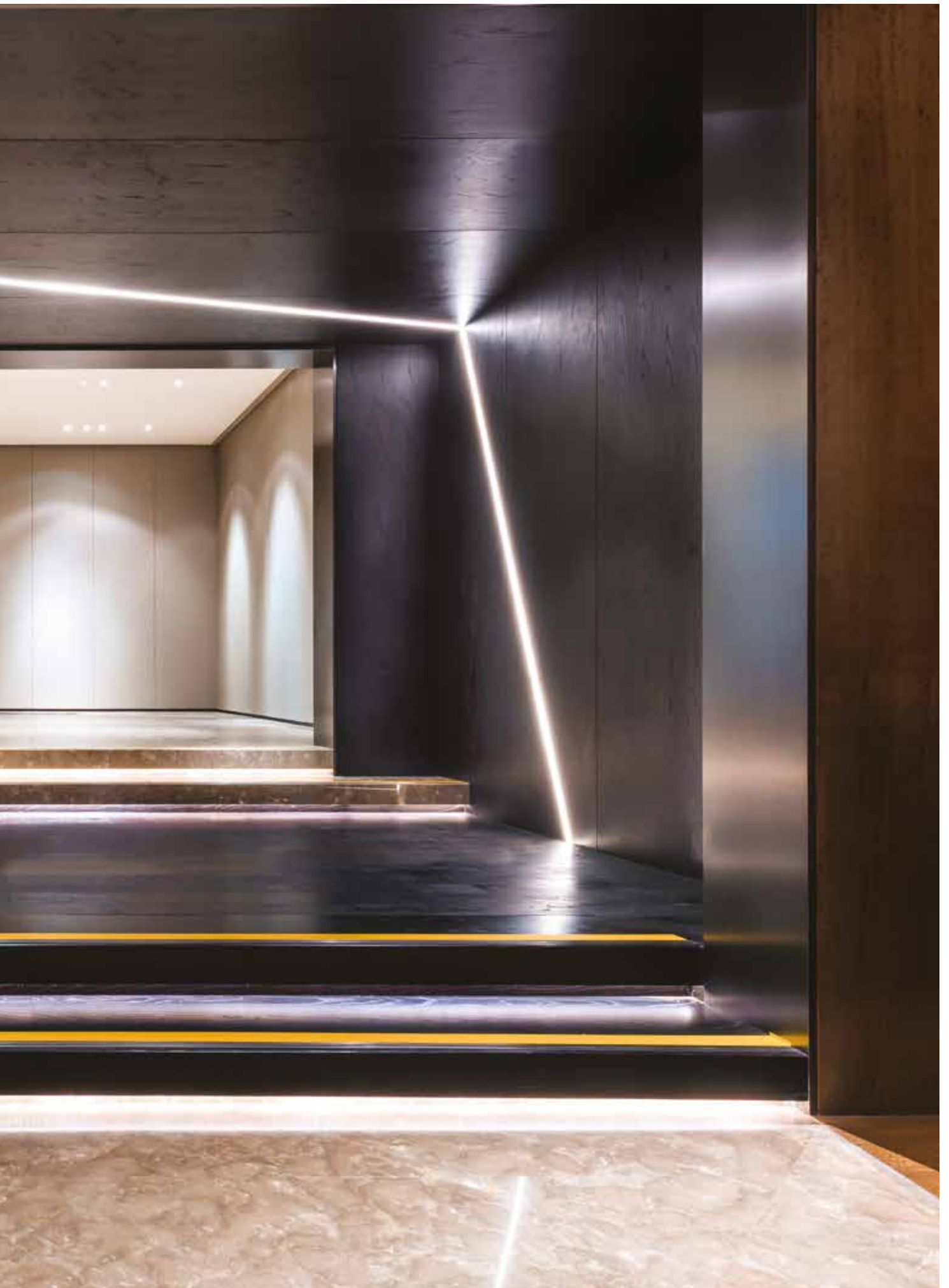

REBA 50



Características del producto

Cuerpo

Perfil de aluminio extruido

Acabado

Pintado en epoxi-poliéster

Sistema óptico

bGLARE - Difusor microprismático

bLINE - Difusor opalino

ASYM - Difusor Asimétrico

Fuente de luz

LED, RG1, CRI>80, MacAdam Step ≤ 3

Vida útil del LED

80.000h @ L90, B10, Ta 25°C

Fuente de alimentación

Driver LED 220-240V-50/60Hz incluido



01. Seleccionar perfil exterior

PERFIL EXTERIOR

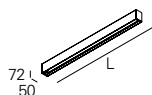

Lmm	CÓDIGO*
578	90517L0020▲0000
858	90517L0030▲0000
1138	90517L0040▲0000
1418	90517L0050▲0000
1698	90517L0060▲0000
1980	90517L0070▲0000
2260	90517L0080▲0000
2540	90517L0090▲0000
2820	90517L0100▲0000



*Sustituya los símbolos para completar el código

Color	▲
□ Blanco	W
■ Gris	G
■ Negro	B

PERFIL EXTERIOR

- Para completar el producto, es necesario pedir el perfil interior por separado.
- Para la versión suspendida, es necesario pedir suspensiones, cable y base de alimentación por separado.

02. Seleccionar perfil interior y difusor

PERFIL INTERIOR | SIMÉTRICO

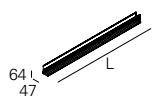

bGLARE - Difusor microprismático

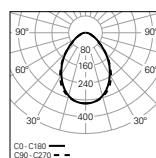

W	lm output	lm/W	Lmm	CÓDIGO*
15	1603	107	562	90498L002▼W0◆00
22	2405	109	842	90498L003▼W0◆00
30	3207	107	1122	90498L004▼W◆◆00
35	4008	115	1402	90498L005▼W◆◆00
42	4810	115	1682	90498L006▼W◆◆00
52	5612	108	1964	90498L007▼W◆◆00
60	6413	107	2244	90498L008▼W◆◆00
65	7215	111	2524	90498L009▼W◆◆00
70	8017	115	2804	90498L010▼W◆◆00

*Sustituya los símbolos para completar el código

Fuente de alimentación	▼
HF	E
DALI	H

Emergencia	●
No EM	0
EM 3h (K3) ^{1,2}	3

Temp. de color	◆
3000K	3
4000K	0
Tunable White ³	T

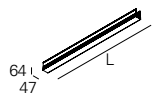

bLINE - Difusor opalino

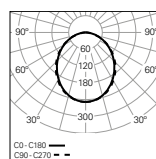

W	lm output	lm/W	Lmm	CÓDIGO*
15	1655	110	562	90497L002▼W0◆00
22	2483	113	842	90497L003▼W0◆00
30	3310	110	1122	90497L004▼W◆◆00
35	4138	118	1402	90497L005▼W◆◆00
42	4965	118	1682	90497L006▼W◆◆00
52	5793	111	1964	90497L007▼W◆◆00
60	6620	110	2244	90497L008▼W◆◆00
65	7448	115	2524	90497L009▼W◆◆00
70	8275	118	2804	90497L010▼W◆◆00

PERFIL INTERIOR | ASIMÉTRICO

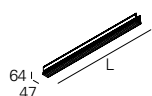

ASYM - Difusor

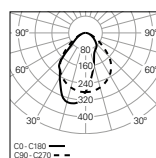







W	lm output	lm/W	Lmm	CÓDIGO*
16	1396	87	562	90500L002▼W0◆00
23	2095	91	842	90500L003▼W0◆00
29	2793	96	1122	90500L004▼W◆◆00
36	3491	97	1402	90500L005▼W◆◆00
44	4189	95	1682	90500L006▼W◆◆00
52	4888	94	1964	90500L007▼W◆◆00
58	5586	96	2244	90500L008▼W◆◆00
65	6284	97	2524	90500L009▼W◆◆00
73	6982	96	2804	90500L010▼W◆◆00

¹ Preparado para telemando.

² Versiones DALI + EM 3h (K3) sólo disponibles a partir de L1402 mm.

³ Sólo disponible en versiones DALI sin kit de emergencia (No EM). No disponible en la versión L562 mm.

03. Seleccionar opciones

OPCIONES	Código*
SwitchDIM Tunable White	926600
<ul style="list-style-type: none"> • Para $L \leq 1682$ mm permite controlar un máximo de 20 luminarias, $L \geq 1964$ mm permite controlar un máximo de 10 luminarias por cada SwitchDIM Tunable White. 	
Suspensión	
S5 L1500 mm (x1)	910408
S5 L1500 mm (x2)	910409
S5 L3000 mm (x1)	910419
S5 L3000 mm (x2)	910412
S5 L6000 mm (x1)	910420
S5 L6000 mm (x2)	910421
Cable de alimentación transparente	
L1500 mm - 3 x 0,75 mm ²	940400
L1500 mm - 5 x 0,75 mm ²	940500
L1500 mm - 7 x 0,75 mm ²	940600
L3000 mm - 3 x 0,75 mm ²	940401
L3000 mm - 5 x 0,75 mm ²	940501
L3000 mm - 7 x 0,75 mm ²	940601
L6000 mm - 3 x 0,75 mm ²	940402
L6000 mm - 5 x 0,75 mm ²	940507
L6000 mm - 7 x 0,75 mm ²	940602
<ul style="list-style-type: none"> • Para la opción DALI con kit de emergencia teledomable, es necesario solicitar 2 cables de alimentación de 5 x 0,75 mm². 	
Base cuadrada	
Superficie T25	45  100 978610
Superficie T29 (DALI+K3)	978611
Empotrar T7	 Ø70 35  90 971400
Empotrar T59 (DALI+K3)	971410
Base circular	
Superficie T24	45  Ø95 978600
Superficie T26 (DALI+K3)	978601
Empotrar T5	 Ø70 33  Ø90 971300
Empotrar T27 (DALI+K3)	978700
Versión low output	
<ul style="list-style-type: none"> • Mediante solicitud. 	



*Sustituya los símbolos para completar el código

Color 
 Blanco W
 Negro B



Detalles del producto

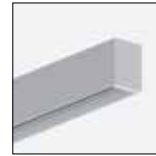

Perfil exterior

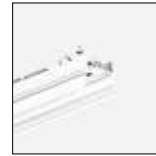

Perfil interno simétrico



Perfil interior Asimétrico



Tapas sin tornillos visibles



Uniformidad de la luz



Suspensión



Difusor clip-in

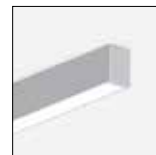

Aplicación de superficie



Aplicación suspendida



Difusor bGLARE



Difusor bLINE



Difusor ASYM



SwitchDIM Tunable White

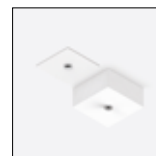

Base cuadrada



Base circular



REBA 50 Line



Características del producto

Cuerpo

Perfil de aluminio extruido

Acabado

Pintado en epoxi-poliéster

Sistema óptico

bGLARE - Difusor microprismático

bLINE - Difusor opalino

ASYM - Difusor Asimétrico

Fuente de luz

LED, RG1, CRI>80, MacAdam Step ≤ 3

Vida útil del LED

80.000h @ L90, B10, Ta 25°C

Fuente de alimentación

Driver LED 220-240V-50/60Hz incluido



230V/50Hz

IP 40

ASYM
850°C

bGLARE
850°C

bLINE
960°C

01. Seleccionar perfil exterior



PERFIL EXTERIOR

Inicial / Final (SRT/END)

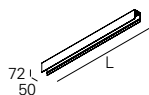

Lmm	CÓDIGO*
567	90505L0020▲0083
847	90505L0030▲0083
1127	90505L0040▲0083
1407	90505L0050▲0083
1687	90505L0060▲0083
1969	90505L0070▲0083
2249	90505L0080▲0083
2529	90505L0090▲0083
2809	90505L0100▲0083

*Sustituya los símbolos para completar el código

Color	▲
□ Blanco	W
■ Gris	G
■ Negro	B

Intermedio (MID)

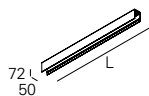

Lmm	CÓDIGO*
562	90505L0020▲0000
842	90505L0030▲0000
1122	90505L0040▲0000
1402	90505L0050▲0000
1682	90505L0060▲0000
1964	90505L0070▲0000
2244	90505L0080▲0000
2524	90505L0090▲0000
2804	90505L0100▲0000

Ángulo vertical (VRT)

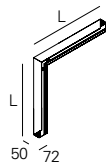

Lmm	CÓDIGO*
606	90505V0040▲0000

Ángulo horizontal (HRZ) - Ángulo horizontal (EDGE)

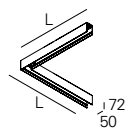

Lmm	CÓDIGO*
601	90505H0040▲0000

PERFIL EXTERIOR

- Para completar el producto, es necesario pedir el perfil interior por separado.
- Para la versión suspendida, es necesario pedir suspensiones, cable y base de alimentación por separado.
- Para completar una línea, es necesario un Start Kit, cableado de línea continua y kit de unión. Por favor solicítelo por separado.
- Las dimensiones no incluyen el star kit. Incremente 6 mm a la longitud para completar la línea.
- La longitud máxima de línea con un solo punto de alimentación es de 30000 mm.

02. Seleccionar perfil interior y difusor



PERFIL INTERIOR | SIMÉTRICO

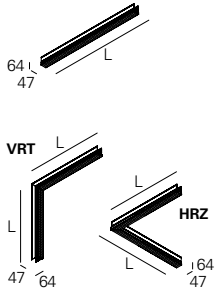

bGLARE - Difusor microprismático

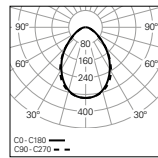

W	lm output	lm/W	Lmm	CÓDIGO*	
15	1603	107	562	90498L002♥VV0♦00	
22	2405	109	842	90498L003♥VV0♦00	
30	3207	107	1122	90498L004♥VV♦♦00	
35	4008	115	1402	90498L005♥VV♦♦00	
42	4810	115	1682	90498L006♥VV♦♦00	
52	5612	108	1964	90498L007♥VV♦♦00	
60	6413	107	2244	90498L008♥VV♦♦00	
65	7215	111	2524	90498L009♥VV♦♦00	
70	8017	115	2804	90498L010♥VV♦♦00	
VRT	30	3207	107	599	90498V004♥VV0♦00
HRZ	30	3207	107	577	90498H004♥VV0♦00

bLINE - Difusor opalino

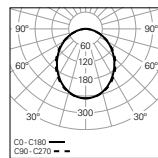

W	lm output	lm/W	Lmm	CÓDIGO*	
15	1655	110	562	90497L002♥VV0♦00	
22	2483	113	842	90497L003♥VV0♦00	
30	3310	110	1122	90497L004♥VV♦♦00	
35	4138	118	1402	90497L005♥VV♦♦00	
42	4965	118	1682	90497L006♥VV♦♦00	
52	5793	111	1964	90497L007♥VV♦♦00	
60	6620	110	2244	90497L008♥VV♦♦00	
65	7448	115	2524	90497L009♥VV♦♦00	
70	8275	118	2804	90497L010♥VV♦♦00	
VRT	30	3310	110	599	90497V004♥VV0♦00
HRZ	30	3310	110	577	90497H004♥VV0♦00

PERFIL INTERIOR | ASIMÉTRICO

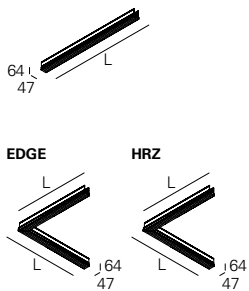

ASYM - Difusor

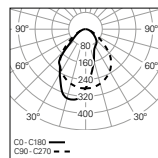

W	lm output	lm/W	Lmm	CÓDIGO*	
16	1396	87	562	90500L002♥VV0♦00	
23	2095	91	842	90500L003♥VV0♦00	
29	2793	96	1122	90500L004♥VV♦♦00	
36	3491	97	1402	90500L005♥VV♦♦00	
44	4189	95	1682	90500L006♥VV♦♦00	
52	4888	94	1964	90500L007♥VV♦♦00	
58	5586	96	2244	90500L008♥VV♦♦00	
65	6284	97	2524	90500L009♥VV♦♦00	
73	6982	96	2804	90500L010♥VV♦♦00	
EDGE	29	2793	96	599	90500E004♥VV0♦00
HRZ	29	2793	96	577	90500H004♥VV0♦00

*Sustituya los símbolos para completar el código

Fuente de alimentación ♥
HF E
DALI H

Emergencia ●
No EM 0
EM 3h (K3) ^{1 2} 3

Temp. de color ♦
3000K 3
4000K 0
Tunable White ³ T

¹ Preparado para telemando.

² Versiones DALI + EM 3h (K3) sólo disponibles a partir de L1402 mm.

³ Sólo disponible en versiones DALI sin kit de emergencia (No EM). No disponible en la versión L562 mm.

03. Seleccionar opciones

OPCIONES	Código*
SwitchDIM Tunable White • Para L ≤ 1682 mm permite controlar un máximo de 20 luminarias, L ≥ 1964 mm permite controlar un máximo de 10 luminarias or cada SwitchDIM Tunable White.	926600
Start kit - Tapas inicio/final • Dos tapas finales incluidas.	72 50 3 923100▲
Cableado de línea continua • Estándar 3 x 1,5 mm ² 5 x 1,5 mm ²	945650 945750
• 2 x 1,5 mm² HF+K3 (x1) - L562 - L1682 mm HF+K3 (x2) - L1964 - L2804 mm	948000 948001
• 2 x 1,5 mm² + Borna de conexión 5P DALI+K3 (x1) - L562 - L1682 mm DALI+K3 (x2) - L1964 - L2804 mm	948200 948201
• 2 x 1,5 mm² + 2 x 0,75 mm² + Borna de conexión 5P K3+TEL (x1) - L562 - L1682 mm K3+TEL (x2) - L1964 - L2804 mm	948100 948101
Kit de unión • Unión galvanizada, tornillos incluidos.	932100
Suspensión S5 L1500 mm (x1) S5 L1500 mm (x2) S5 L3000 mm (x1) S5 L3000 mm (x2) S5 L6000 mm (x1) S5 L6000 mm (x2)	910408 910409 910419 910412 910420 910421
Cable de alimentación transparente 3 x 1,5 mm ² 5 x 1,5 mm ² 7 x 1,5 mm ² • Para la opción DALI con kit de emergencia telemandable, es necesario solicitar 2 cables de alimentación de 5 x 1,5 mm ² .	94030▲ 94000▲ 94010▲
Base cuadrada³ Superficie T25 Superficie T29 (DALI+K3) Empotrar T7 Empotrar T59 (DALI+K3)	45 100 90 978610▲ 978611▲ Ø70 35 90 971400▲ 971410▲
Base circular³ Superficie T24 Superficie T26 (DALI+K3) Empotrar T5 Empotrar T27 (DALI+K3)	45 Ø95 978600▲ 978601▲ Ø70 33 Ø90 971300▲ 978700▲
Módulo ciego L1500 mm L3000 mm • Incluye perfil interior vacío y tapa ciega de aluminio.	992900▲ 992901▲
Versión low output • Mediante solicitud.	
Proyectos a medida • Mediante solicitud.	



*Sustituya los símbolos para completar el código

Longitud	▲
L1500 mm	0
L3000 mm	1
L6000 mm	2

Color ³	▲
□ Blanco	W
■ Gris	G
■ Negro	B



Detalles del producto



³ Bases de techo solo están disponibles en blanco o negro.

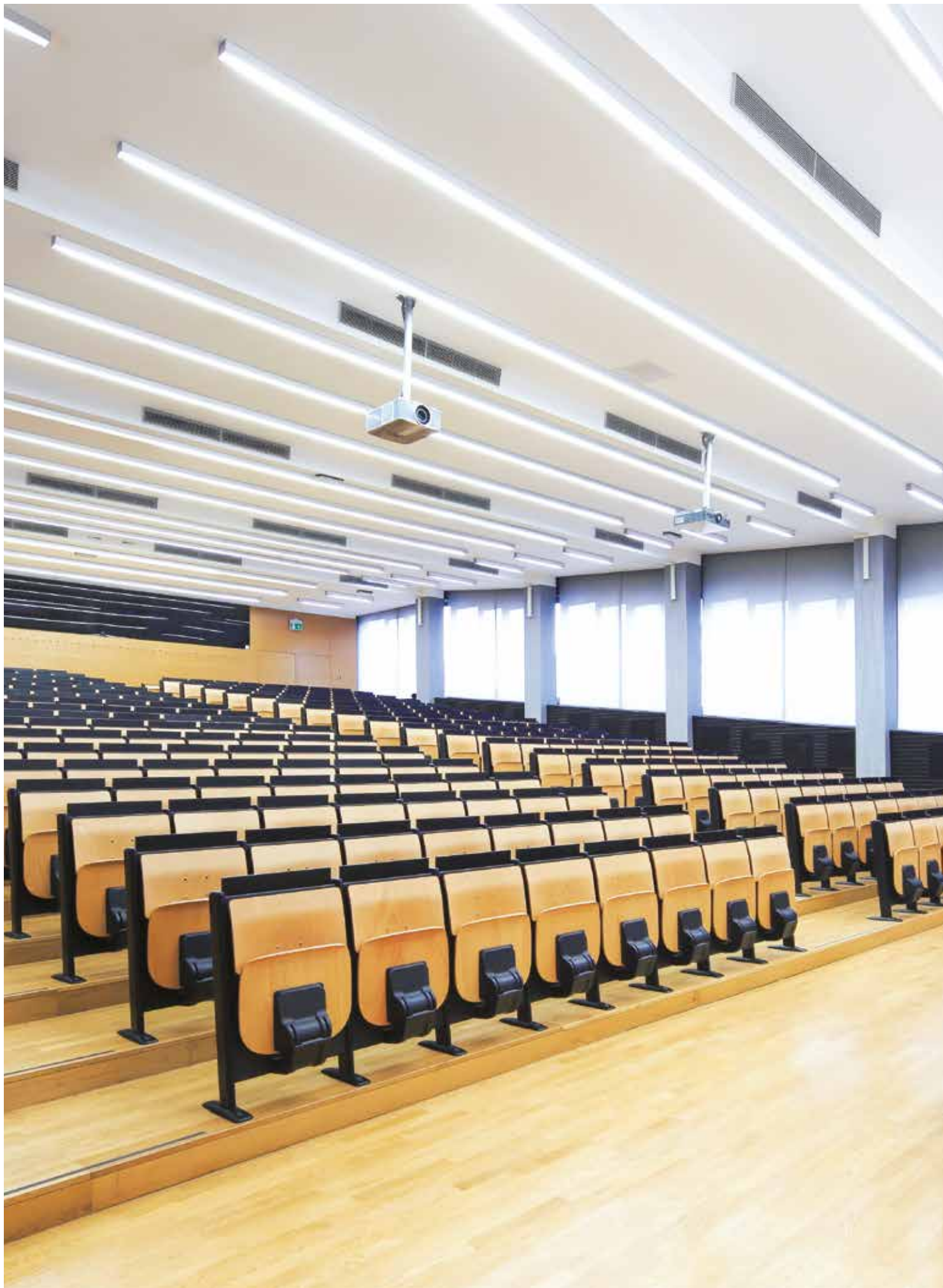



Composición de los elementos estructurales

1. Tapas

2. Perfil exterior

- 2.1 Módulo inicial/final (SRT/END).
- 2.2 Módulo intermedio (MID).

3. Difusores

- 3.1 Difusor bGLARE
- 3.2 Difusor bLINE

4. Kit de unión

- 4.1 2 vías
- 4.2 3 vías

5. Base de techo

6. Cable de alimentación

7. Suspensión

Módulos disponibles

(Vista desde arriba)

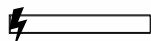

Módulo inicial/final (SRT/END)

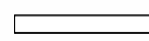

Módulo intermedio (MID)

Cómo montar una línea

(Vista desde arriba)

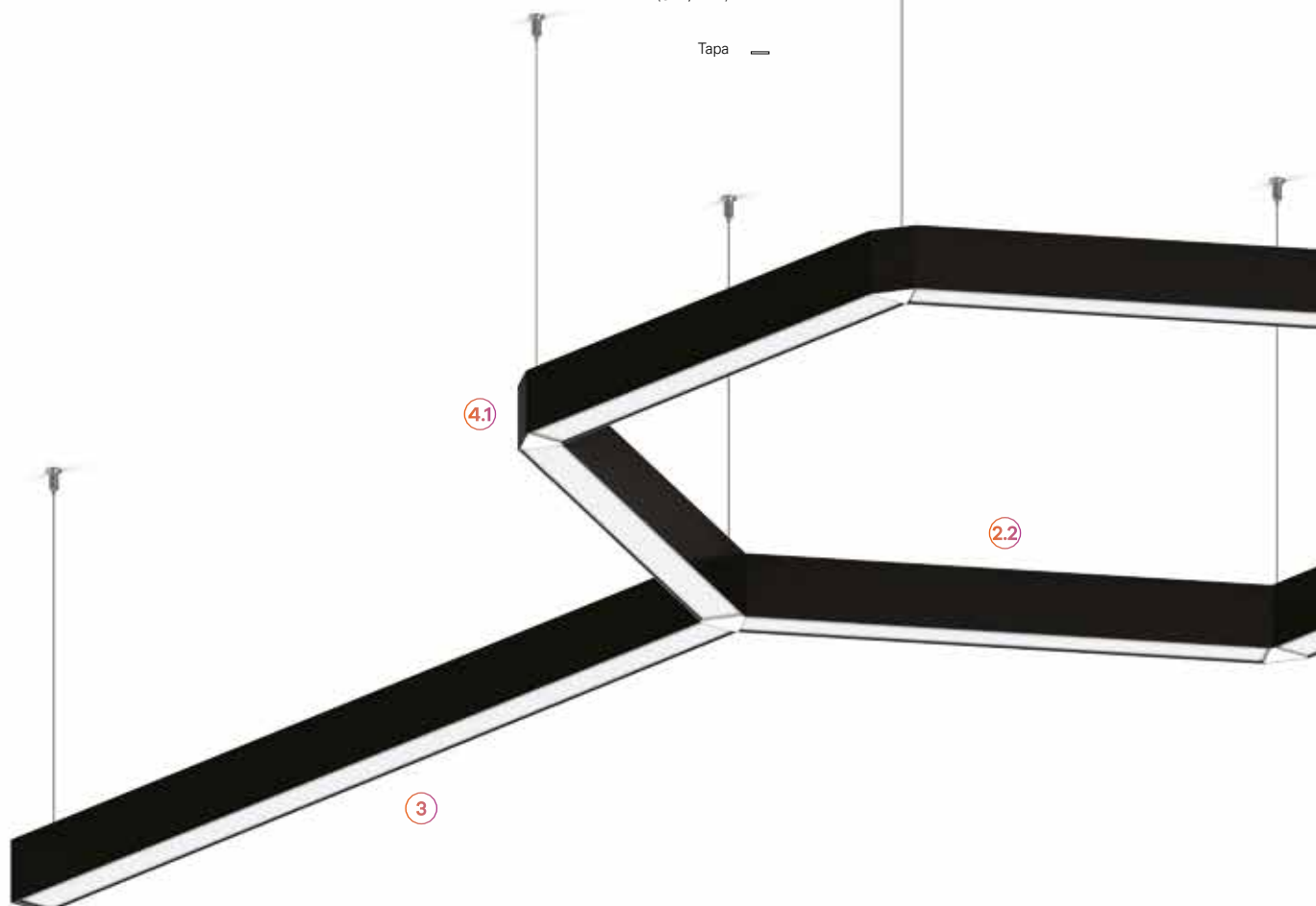
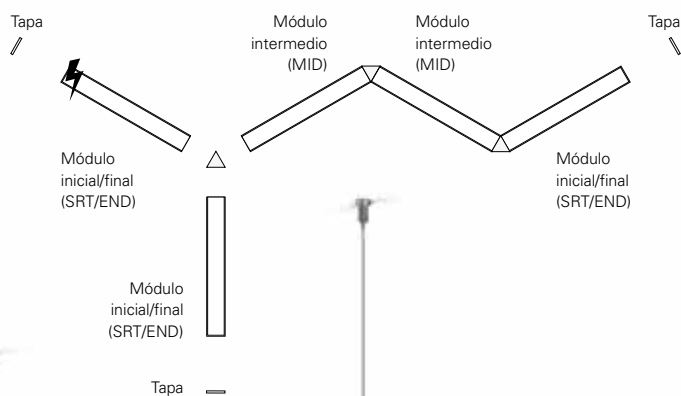

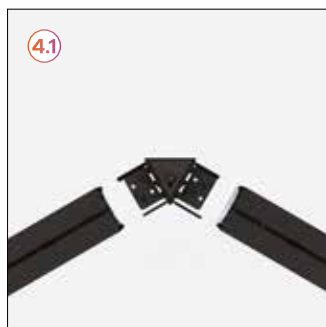
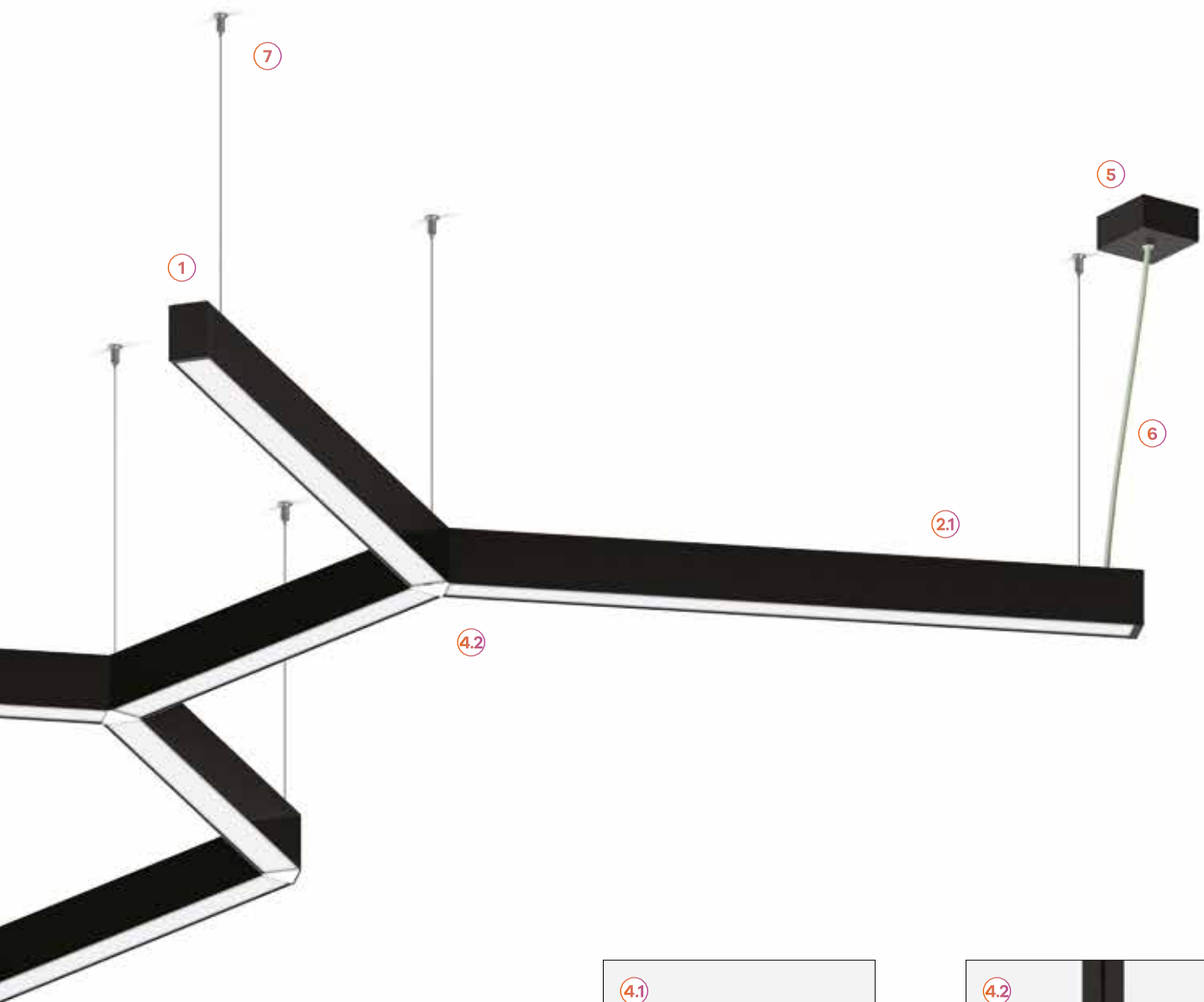

Una elección versátil para su proyecto

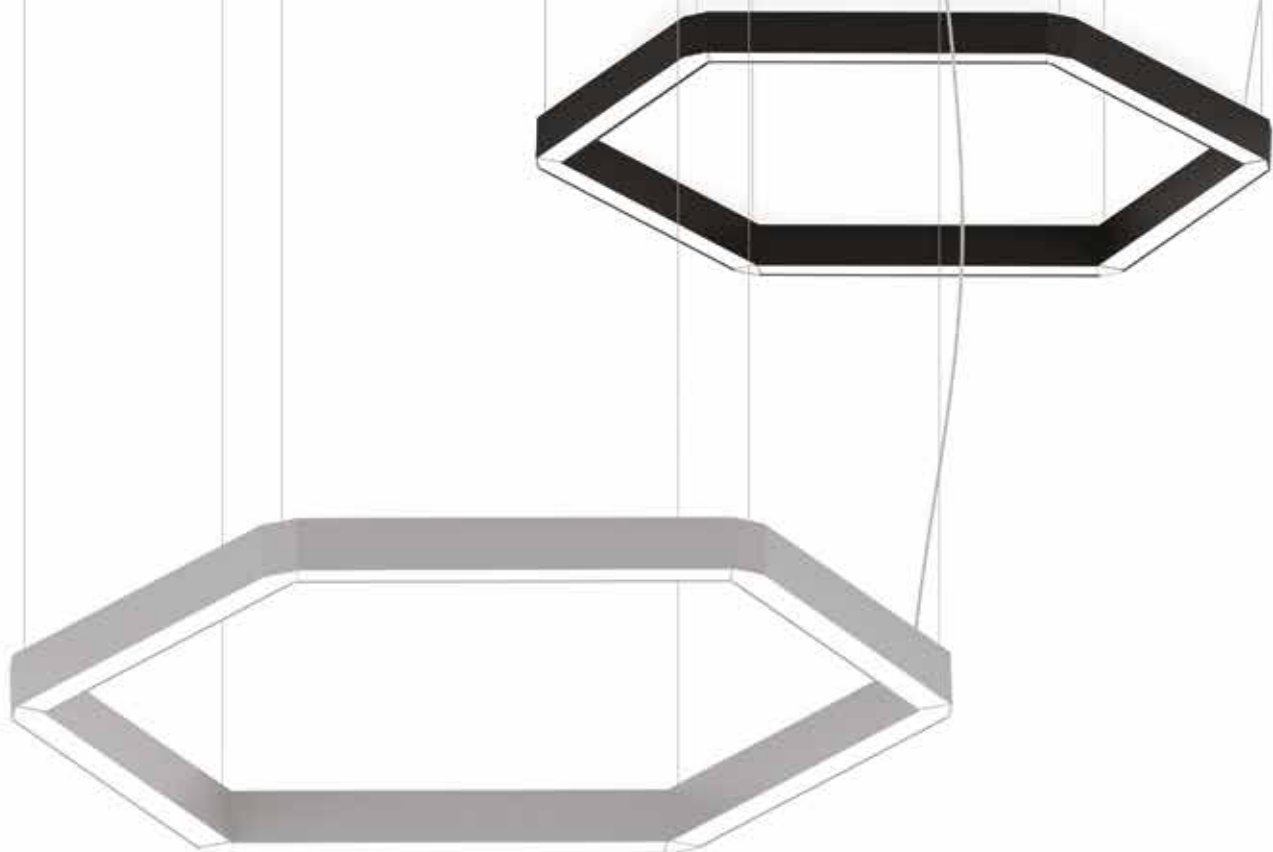

COMPUESTO
(varios módulos)

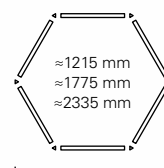

Módulos disponibles

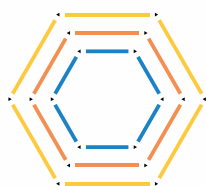

Escala 1:100 1000 mm

	Nº DE MÓDULOS	KIT DE UNIÓN	Nº DE SUSPENSIONES
562 mm	6	6 (2 vías)	6
842 mm	6	6 (2 vías)	6
1122 mm	6	6 (2 vías)	6

REBA 50 HEXA

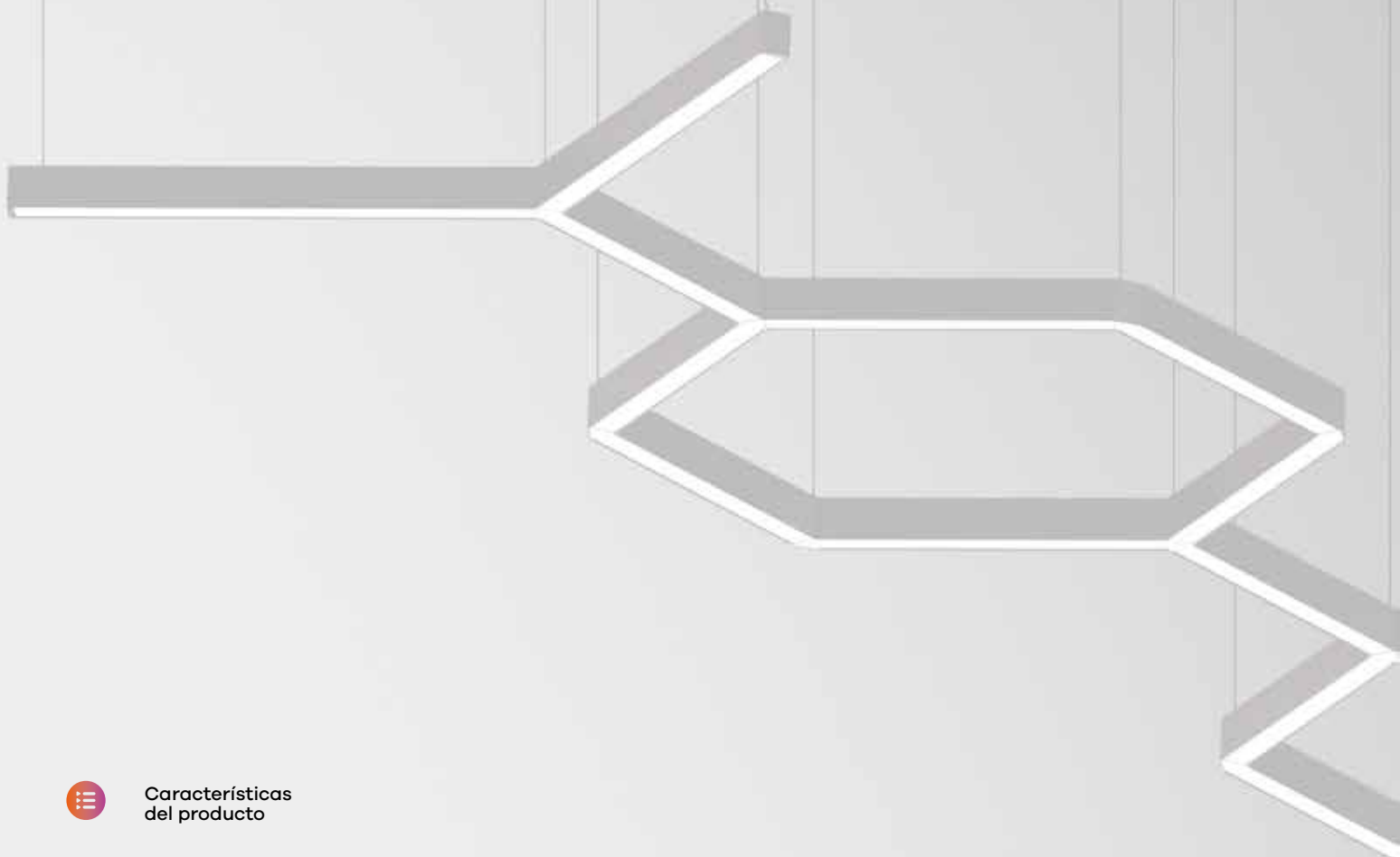

Características del producto

Cuerpo

Perfil de aluminio extruido

Acabado

Pintado en epoxi-poliéster

Sistema óptico

bGLARE - Difusor microprismático
bLINE - Difusor opalino

Fuente de luz

LED, RG1, CRI>80, MacAdam Step ≤3

Vida útil del LED

80.000h @ L90, B10, Ta 25°C

Fuente de alimentación

Driver LED 220-240V-50/60Hz incluido



230V/50Hz

IP 40

bGLARE
850°C

bLINE
960°C

01. Seleccionar perfil exterior

PERFIL EXTERIOR

Inicial / Final (SRT/END)

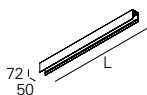

Lmm	CÓDIGO*
567	90505L0020▲0083
847	90505L0030▲0083
1127	90505L0040▲0083

Intermedio (MID)

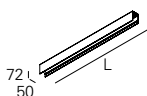

Lmm	CÓDIGO*
562	90860L0020▲0000
842	90860L0030▲0000
1122	90860L0040▲0000

PERFIL EXTERIOR

- Para completar el producto, es necesario pedir el perfil interior por separado.
- Para la versión suspendida, es necesario pedir suspensiones, cable y base de alimentación por separado.
- Para completar una línea, es necesario un Start Kit, cableado de línea continua y kit de unión. Por favor solicítelo por separado.
- Las dimensiones no incluyen el star kit. Incremente 6 mm a la longitud para completar la línea.
- La longitud máxima de línea con un único punto de alimentación es mediante solicitud.



*Sustituya los símbolos para completar el código

Color	▲
□ Blanco	W
■ Gris	G
■ Negro	B

02. Seleccionar perfil interior y difusor

PERFIL INTERIOR | SIMÉTRICO

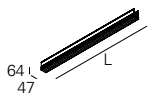

bGLARE - Difusor microprismático

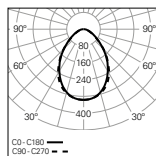

W	lm output	lm/W	Lmm	CÓDIGO*
15	1603	107	562	90816L002▼W0♦00
22	2405	109	842	90816L003▼W0♦00
30	3207	107	1122	90816L004▼W0♦00

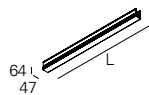

bLINE - Difusor opalino

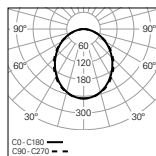

W	lm output	lm/W	Lmm	CÓDIGO*
15	1655	110	562	90814L002▼W0♦00
22	2483	113	842	90814L003▼W0♦00
30	3310	110	1122	90814L004▼W0♦00







*Sustituya los símbolos para completar el código

Fuente de alimentación	▼
HF	E
DALI	H

Temp. de color	♦
3000K	3
4000K	0

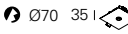
03. Seleccionar opciones

OPCIONES	Código*
Start kit - Tapas inicio/final (x1) 	923101▲
Kit de unión	
2 vías HF	932148▲
2 vías DALI	932149▲
3 vías HF	932150▲
3 vías DALI	932151▲
• Tapa de unión en blanco.	
• Cableado de línea continua incluido.	
Suspensión	
S5 L1500 mm (x1)	910408
S5 L1500 mm (x2)	910409
S5 L3000 mm (x1)	910419
S5 L3000 mm (x2)	910412
S5 L6000 mm (x1)	910420
S5 L6000 mm (x2)	910421
Cable de alimentación transparente	
3 x 1,5 mm ²	94030▲
5 x 1,5 mm ²	94000▲
Base cuadrada¹	
Superficie T25 	978610▲
Empotrar T7 	971400▲
Base circular¹	
Superficie T24 	978600▲
Empotrar T5 	971300▲
Versión low output	
• Mediante solicitud.	
Proyectos a medida	
• Mediante solicitud.	



*Sustituya los símbolos para completar el código

Longitud	▲
L1500 mm	0
L3000 mm	1
L6000 mm	2

Color ¹	▲
<input type="checkbox"/> Blanco	W
<input type="checkbox"/> Gris	G
<input type="checkbox"/> Negro	B



Detalles del producto



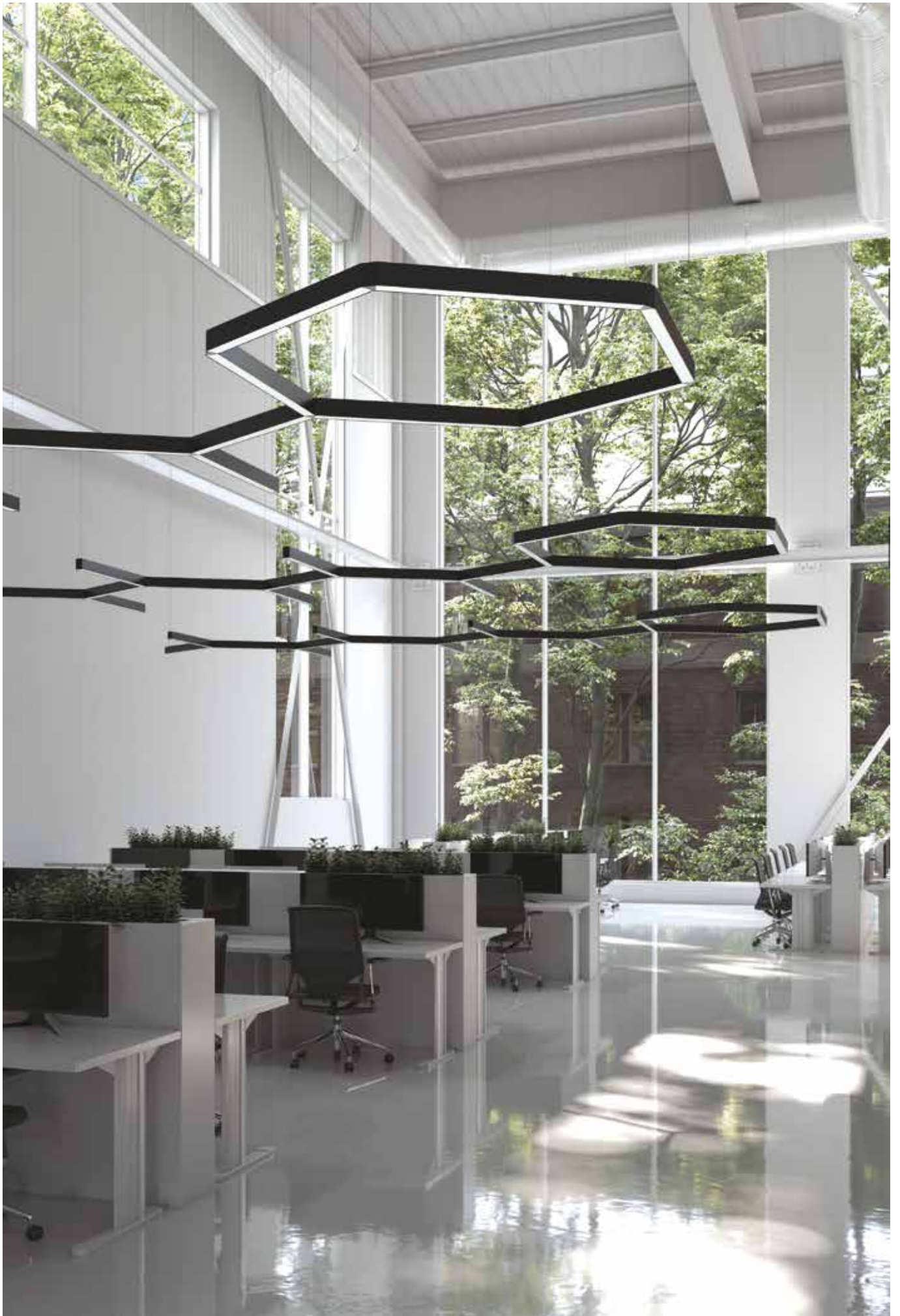

REBA 50 D/I



Características del producto

Cuerpo

Perfil de aluminio extruido

Acabado

Pintado en epoxi-poliéster

Sistema óptico

bGLARE - Difusor microprismático

bLINE - Difusor opalino

ASYM - Difusor Asimétrico

Fuente de luz

LED, RG1, CRI>80, MacAdam Step ≤3

Vida útil del LED

80.000h @ L90, B10, Ta 25°C

Fuente de alimentación

Driver LED 220-240V-50/60Hz incluido



230V/50Hz

IP 40

ASYM
850°C

bGLARE
850°C

bLINE
960°C

01. Seleccionar perfil exterior

PERFIL EXTERIOR

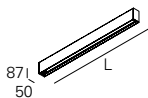

Lmm	CÓDIGO*
1138	90523L0040▲0000
1418	90523L0050▲0000
1698	90523L0060▲0000
2260	90523L0080▲0000
2540	90523L0090▲0000
2820	90523L0100▲0000



*Sustituya los símbolos para completar el código

Color	▲
□ Blanco	W
■ Gris	G
■ Negro	B

PERFIL EXTERIOR

- Difusor de la parte indirecta incluido en el producto.
- Para completar el producto es necesario añadir perfil interior, suspensión, cable de alimentación transparente y base de techo. Por favor solicítelo por separado.

02. Seleccionar perfil interior y difusor

PERFIL INTERIOR | SIMÉTRICO

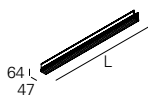

bGLARE - Difusor micropismático (60%/40%)

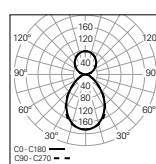

W	lm output	lm/W	Lmm	CÓDIGO*
52	5159	99	1122	90528L004▼W0♦00
65	6633	102	1402	90528L005▼W0♦00
77	8107	105	1682	90528L006▼W0♦00
102	10318	101	2244	90528L008▼W0♦00
117	11792	101	2524	90528L009▼W0♦00
130	13266	102	2804	90528L010▼W0♦00

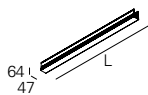

bLINE - Difusor opalino (60%/40%)

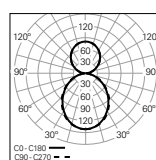

W	lm output	lm/W	Lmm	CÓDIGO*
52	5250	101	1122	90527L004▼W0♦00
65	6749	104	1402	90527L005▼W0♦00
77	8249	107	1682	90527L006▼W0♦00
102	10499	103	2244	90527L008▼W0♦00
117	11999	103	2524	90527L009▼W0♦00
130	13499	104	2804	90527L010▼W0♦00



*Sustituya los símbolos para completar el código

Fuente de alimentación	▼
HF	E
DALI	H
HF+CD ¹	Q
SWD+CD ²	Y

Emergencia	●
No EM	0
EM 3h (K3) ³	3

Temp. de color	◆
3000K	3
4000K	0
Tunable White ⁴	T

PERFIL INTERIOR | ASIMÉTRICO

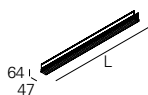

ASYM - Difusor (60%/40%)

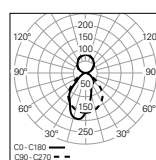

W	lm output	lm/W	Lmm	CÓDIGO*
51	4707	92	1122	90530L004▼W0♦00
66	6051	92	1402	90530L005▼W0♦00
79	7396	94	1682	90530L006▼W0♦00
100	9413	94	2244	90530L008▼W0♦00
117	10758	92	2524	90530L009▼W0♦00
133	12102	91	2804	90530L010▼W0♦00





¹ HF + Doble circuito.

² SwitchDIM + Doble circuito.

³ Preparado para telemando.

⁴ Sólo disponible en las versiones DALI y SWD+CD sin kit de emergencia (No EM).

03. Seleccionar opciones

OPCIONES	Código*
SwitchDIM Tunable White	926600
<ul style="list-style-type: none"> • Para L ≤ 1682 mm permite controlar un máximo de 10 luminarias, L ≥ 1964 mm permite controlar un máximo de 5 luminarias por cada SwitchDIM Tunable White. 	
Suspensión	
S5 L1500 mm (x1)	910408
S5 L1500 mm (x2)	910409
S5 L3000 mm (x1)	910419
S5 L3000 mm (x2)	910412
S5 L6000 mm (x1)	910420
S5 L6000 mm (x2)	910421
Cable de alimentación transparente	
L1500 mm - 3 x 0,75 mm ²	940400
L1500 mm - 5 x 0,75 mm ²	940500
L1500 mm - 7 x 0,75 mm ²	940600
L3000 mm - 3 x 0,75 mm ²	940401
L3000 mm - 5 x 0,75 mm ²	940501
L3000 mm - 7 x 0,75 mm ²	940601
L6000 mm - 3 x 0,75 mm ²	940402
L6000 mm - 5 x 0,75 mm ²	940507
L6000 mm - 7 x 0,75 mm ²	940602
<ul style="list-style-type: none"> • Para la opción DALI con kit de emergencia teledomable, es necesario solicitar 2 cables de alimentación de 5 x 0,75 mm². 	
Base cuadrada	
Superficie T25	45  100 978610♣
Superficie T29 (DALI+K3)	978611♣
Empotrar T7	 Ø70 35  90 971400♣
Empotrar T59 (DALI+K3)	971410♣
Base circular	
Superficie T24	45  Ø95 978600♣
Superficie T26 (DALI+K3)	978601♣
Empotrar T5	 Ø70 33  Ø90 971300♣
Empotrar T27 (DALI+K3)	978700♣
Versión low output	
<ul style="list-style-type: none"> • Mediante solicitud. 	



*Sustituya los símbolos para completar el código

Color ♣
 Blanco W
 Negro B



Detalles del producto

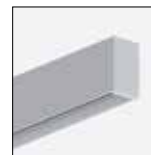

Perfil exterior



Perfil interno simétrico



Perfil interior asimétrico

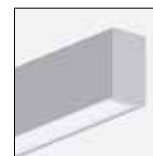

Tapas sin tornillos visibles



Uniformidad de la luz



Suspensión



Difusor clip-in

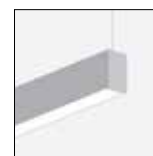

Aplicación suspendida



Difusor bGLARE



Difusor bLINE



Difusor ASYM



SwitchDIM Tunable White

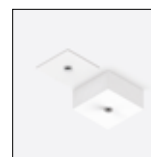

Base cuadrada



Base circular



REBA 50 D/I Line



Características del producto

Cuerpo

Perfil de aluminio extruido

Acabado

Pintado en epoxi-poliéster

Sistema óptico

bGLARE - Difusor microprismático

bLINE - Difusor opalino

ASYM - Difusor Asimétrico

Fuente de luz

LED, RG1, CRI>80, MacAdam Step ≤ 3

Vida útil del LED

80.000h @ L90, B10, Ta 25°C

Fuente de alimentación

Driver LED 220-240V-50/60Hz incluido



230V/50Hz

IP 40

ASYM
850°C

bGLARE
850°C

bLINE
960°C

01. Seleccionar perfil exterior



PERFIL EXTERIOR

Inicial / Final (SRT/END)

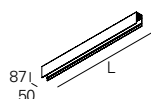

Lmm	CÓDIGO*
1127	90508L0040▲0083
1407	90508L0050▲0083
1687	90508L0060▲0083
2249	90508L0080▲0083
2529	90508L0090▲0083
2809	90508L0100▲0083

*Sustituya los símbolos para completar el código

Color	▲
□ Blanco	W
■ Gris	G
■ Negro	B

Intermedio (MID)

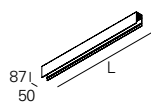

Lmm	CÓDIGO*
1122	90508L0040▲0000
1402	90508L0050▲0000
1682	90508L0060▲0000
2244	90508L0080▲0000
2524	90508L0090▲0000
2804	90508L0100▲0000

Ángulo horizontal (HRZ) - Ángulo horizontal (EDGE)

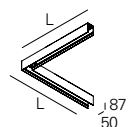

Lmm	CÓDIGO*
601	90508H0040▲0000

PERFIL EXTERIOR

- Difusor de la parte indirecta incluido en el producto.
- Para completar el producto, es necesario pedir el perfil interior por separado.
- Para la versión suspendida, es necesario pedir suspensiones, cable y base de alimentación por separado.
- Para completar una línea, es necesario un Start Kit, cableado de línea continua y kit de unión. Por favor solicítelo por separado.
- Las dimensiones no incluyen el star kit. Incremente 6 mm a la longitud para completar la línea.
- La longitud máxima de línea con un solo punto de alimentación es de 15000 mm.

02. Seleccionar perfil interior y difusor



PERFIL INTERIOR | SIMÉTRICO

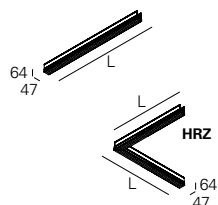

bGLARE - Difusor microprismático (60%/40%)

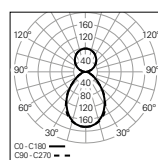

W	lm output	lm/W	Lmm	CÓDIGO*
52	5159	99	1120	90528L004♥W0♦00
65	6633	102	1400	90528L005♥W0♦00
77	8107	105	1680	90528L006♥W♦♦00
102	10318	101	2240	90528L008♥W0♦00
117	11792	101	2520	90528L009♥W0♦00
130	13266	102	2800	90528L010♥W0♦00

HRZ	45	4422	98	597	90528H004♥W0♦00
-----	----	------	----	-----	-----------------

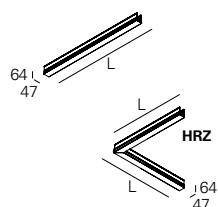

bLINE - Difusor opalino (60%/40%)

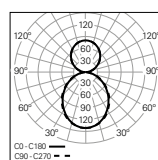

W	lm output	lm/W	Lmm	CÓDIGO*
52	5250	101	1120	90527L004♥W0♦00
65	6749	104	1400	90527L005♥W0♦00
77	8249	107	1680	90527L006♥W♦♦00
102	10499	103	2240	90527L008♥W0♦00
117	11999	103	2520	90527L009♥W0♦00
130	13499	104	2800	90527L010♥W0♦00

HRZ	45	4500	100	597	90527H004♥W0♦00
-----	----	------	-----	-----	-----------------

*Sustituya los símbolos para completar el código

Fuente de alimentación

HF	E
DALI	H
HF+CD ¹	Q
SWD+CD ²	Y

Emergencia

No EM	0
EM 3h (K3) ³	3

Temp. de color

3000K	3
4000K	0
Tunable White ⁴	T

PERFIL INTERIOR | ASIMÉTRICO

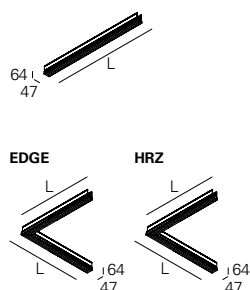

ASYM - Difusor (60%/40%)

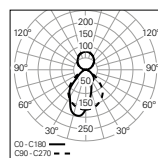

W	lm output	lm/W	Lmm	CÓDIGO*
51	4707	92	1120	90530L004♥W0♦00
66	6051	92	1400	90530L005♥W0♦00
79	7396	94	1680	90530L006♥W♦♦00
100	9413	94	2240	90530L008♥W0♦00
117	10758	92	2520	90530L009♥W0♦00
133	12102	91	2800	90530L010♥W0♦00

EDGE	44	4034	92	597	90530E004♥W0♦00
HRZ	44	4034	92	597	90530H004♥W0♦00









¹ HF + Doble circuito.

² SwitchDIM + Doble circuito.

³ Preparado para telemando.

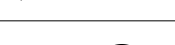
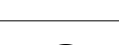
⁴ Sólo disponible en las versiones DALI y SWD+CD sin kit de emergencia (No EM).

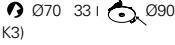
03. Seleccionar opciones

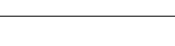
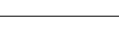
OPCIONES	Código*
SwitchDIM Tunable White	926600
• Para L ≤ 1682 mm permite controlar un máximo de 20 luminarias, L ≥ 1964 mm permite controlar un máximo de 10 luminarias por cada SwitchDIM Tunable White.	
Start kit - Tapas inicio/final	923300▲
• Dos tapas finales incluidas.	
Cableado de línea continua	
• Estándar	
3 x 1,5 mm ²	945650
4 x 1,5 mm ²	948400
5 x 1,5 mm ²	945750
• 2 x 1,5 mm²	
HF+K3 (x1) - L562 - L1682 mm	948000
HF+K3 (x2) - L1964 - L2804 mm	948001
• 2 x 1,5 mm² + Borna de conexión 5P	
DALI+K3 (x1) - L562 - L1682 mm	948200
DALI+K3 (x2) - L1964 - L2804 mm	948201
• 2 x 1,5 mm² + 2 x 0,75 mm² + Borna de conexión 5P	
K3+TEL (x1) - L562 - L1682 mm	948100
K3+TEL (x2) - L1964 - L2804 mm	948101
Kit de unión	932110
• Unión galvanizada, tornillos incluidos.	
Suspensión	
S5 L1500 mm (x1)	910408
S5 L1500 mm (x2)	910409
S5 L3000 mm (x1)	910419
S5 L3000 mm (x2)	910412
S5 L6000 mm (x1)	910420
S5 L6000 mm (x2)	910421
Cable de alimentación transparente	
3 x 1,5 mm ²	94030▲
5 x 1,5 mm ²	94000▲
7 x 1,5 mm ²	94010▲
• Para la opción DALI con kit de emergencia telemandable, es necesario solicitar 2 cables de alimentación de 5 x 1,5 mm ² .	
Base cuadrada ⁵	
Superficie T25	45  100 978610▲
Superficie T29 (DALI+K3)	45  100 978611▲
Empotrar T7	 Ø70 35  90 971400▲
Empotrar T59 (DALI+K3)	 Ø70 35  90 971410▲
Base circular ⁵	
Superficie T24	45  Ø95 978600▲
Superficie T26 (DALI+K3)	45  Ø95 978601▲
Empotrar T5	 Ø70 33  Ø90 971300▲
Empotrar T27 (DALI+K3)	 Ø70 33  Ø90 978700▲
Módulo ciego	
L1500 mm	992940▲
L3000 mm	992941▲
• Incluye perfil interior vacío y tapa ciega de aluminio.	
Versión low output	
• Mediante solicitud.	
Proyectos a medida	
• Mediante solicitud.	



*Sustituya los símbolos para completar el código

Longitud	▲
L1500 mm	0
L3000 mm	1
L6000 mm	2

Color ⁵	▲
<input type="checkbox"/> Blanco	W
<input type="checkbox"/> Gris	G
<input checked="" type="checkbox"/> Negro	B



Detalles del producto



⁵ Bases de techo solo están disponibles en blanco o negro.





REBA 50 /W

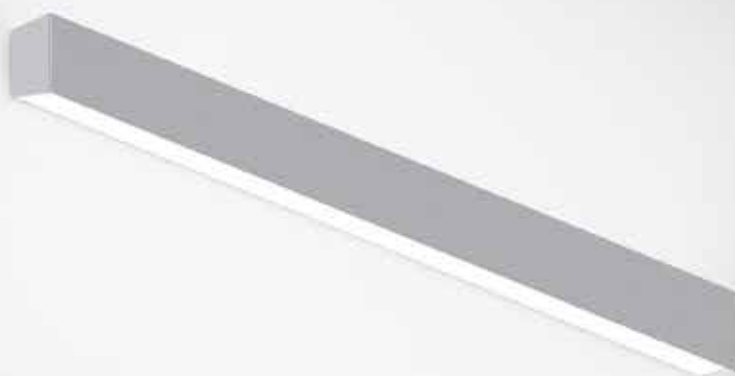

Características del producto

Cuerpo

Perfil de aluminio extruido



Acabado

Pintado en epoxi-poliéster

230V/50Hz

Sistema óptico

bLINE - Difusor opalino



IP 40

Fuente de luz

LED, RG1, CRI>80, MacAdam Step ≤ 3

Vida útil del LED

80.000h @ L90, B10, Ta 25°C



Fuente de alimentación

Driver LED 220-240V-50/60Hz incluido

01. Seleccionar perfil exterior

PERFIL EXTERIOR

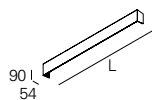

Lmm	CÓDIGO*
1128	90521L0040▲0000
1408	90521L0050▲0000
1688	90521L0060▲0000
1968	90521L0070▲0000
2248	90521L0080▲0000
2528	90521L0090▲0000
2808	90521L0100▲0000



*Sustituya los símbolos para completar el código

Color	▲
□ Blanco	W
■ Gris	G
■ Negro	B

PERFIL EXTERIOR

- Para completar el producto, es necesario pedir el perfil interior por separado.

02. Seleccionar perfil interior y difusor

PERFIL INTERIOR | DERECHO / INDIRECTO

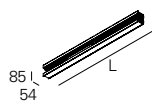

bLINE - Difusor opalino

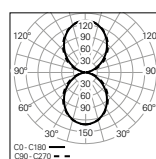

W	lm output	lm/W	Lmm	CÓDIGO*
60	6724	112	1122	90536L004▼W0♦00
70	8405	120	1402	90536L005▼W0♦00
84	10085	120	1682	90536L006▼W0♦00
104	11766	113	1962	90536L007▼W0♦00
120	13447	112	2242	90536L008▼W0♦00
130	15128	116	2522	90536L009▼W0♦00
140	16809	120	2802	90536L010▼W0♦00



*Sustituya los símbolos para completar el código

Fuente de alimentación	▼
HF	E
DALI	H
HF+CD ¹	H
SWD+CD ²	Y

Emergencia	●
No EM	0
EM 3h (K3) ³	3

PERFIL INTERIOR | DERECHO

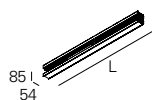

bLINE - Difusor opalino

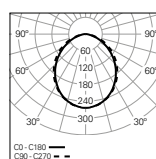

W	lm output	lm/W	Lmm	CÓDIGO*
30	3362	112	1122	90535L004▼W0♦00
35	4202	120	1402	90535L005▼W0♦00
42	5043	120	1682	90535L006▼W0♦00
52	5883	113	1962	90535L007▼W0♦00
60	6724	112	2242	90535L008▼W0♦00
65	7564	116	2522	90535L009▼W0♦00
70	8405	120	2802	90535L010▼W0♦00

Temp. de color	♦
3000K	3
4000K	0
Tunable White ⁴	T

PERFIL INTERIOR | INDIRECTO

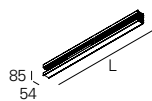

bLINE - Difusor opalino

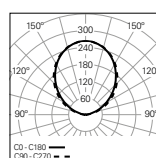

W	lm output	lm/W	Lmm	CÓDIGO*
30	3362	112	1122	90518L004▼W0♦00
35	4202	120	1402	90518L005▼W0♦00
42	5043	120	1682	90518L006▼W0♦00
52	5883	113	1962	90518L007▼W0♦00
60	6724	112	2242	90518L008▼W0♦00
65	7564	116	2522	90518L009▼W0♦00
70	8405	120	2802	90518L010▼W0♦00

¹ HF + Doble circuito.

² SwitchDIM + Doble circuito.

³ Preparado para teledmando.

⁴ Sólo disponible en las versiones DALI y SWD+CD sin kit de emergencia (No EM).

03. Seleccionar opciones

OPCIONES	Código
<p>SwitchDIM Tunable White</p> <ul style="list-style-type: none"> En versiones Directas o Indirectas para $L \leq 1682$ mm permite controlar máx 20 luminarias, $L \geq 1964$ mm permite controlar máx 10 luminarias por cada SwitchDIM Tunable White. En las versiones Directa / Indirecta para $L \leq 1682$ mm permite controlar un máximo de 10 luminarias, $L \geq 1964$ mm permite controlar un máximo de 5 luminarias por cada SwitchDIM Tunable White. 	926600
<p>Señalética</p> <ul style="list-style-type: none"> Permite grabar signos o textos en el perfil exterior. 	
<p>Versión low output</p> <ul style="list-style-type: none"> Mediante solicitud. 	



Detalles del producto



Perfil exterior



Perfil interior



Tapas sin tornillos visibles



Uniformidad de la luz visibles



Difusor clip-in



Aplicación de pared directa / indirecta



Aplicación de pared directa



Aplicación de pared indirecta



Difusor bLINE



SwitchDIM Tunable White



Señalética (Mediante solicitud)



REBA 50 /W Line

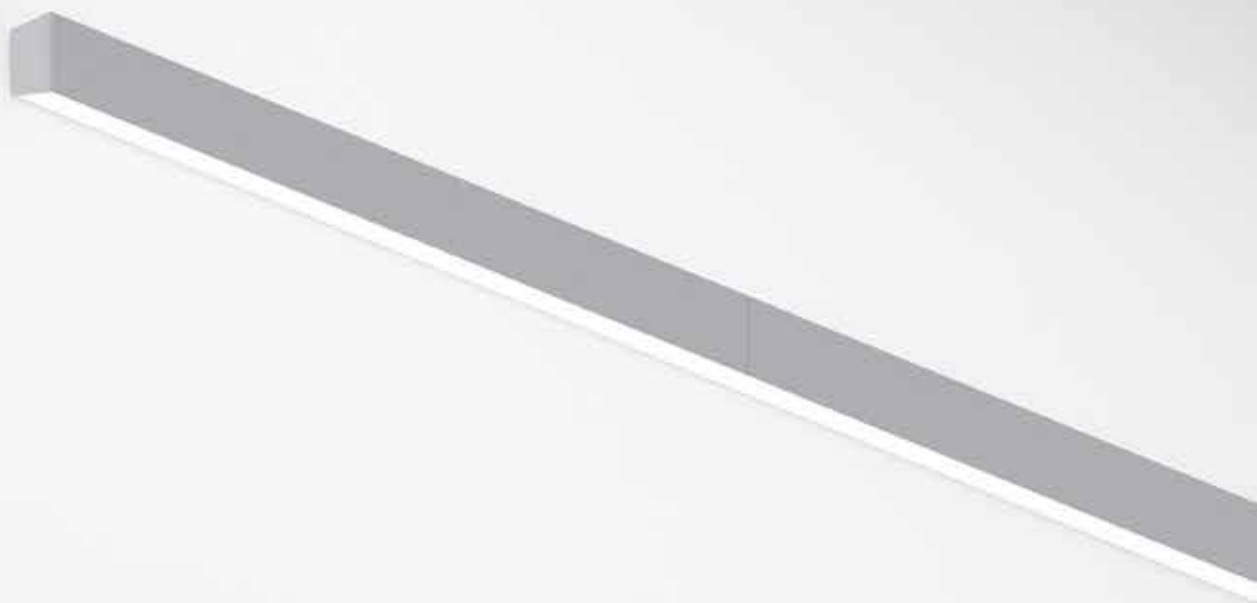

Características del producto

Cuerpo

Perfil de aluminio extruido



Acabado

Pintado en epoxi-poliéster

230V/50Hz

Sistema óptico

bLINE - Difusor opalino



IP 40

Fuente de luz

LED, RG1, CRI>80, MacAdam Step ≤ 3

Vida útil del LED

80.000h @ L90, B10, Ta 25°C



Fuente de alimentación

Driver LED 220-240V-50/60Hz incluido

01. Seleccionar perfil exterior



PERFIL EXTERIOR

Inicial / Final (SRT/END)

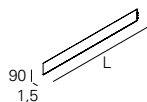

Lmm	CÓDIGO*
1125	90526L0040▲0083
1405	90526L0050▲0083
1685	90526L0060▲0083
1965	90526L0070▲0083
2245	90526L0080▲0083
2525	90526L0090▲0083
2805	90526L0100▲0083

*Sustituya los símbolos para completar el código

Color	▲
□ Blanco	W
■ Gris	G
■ Negro	B

Intermedio (MID)

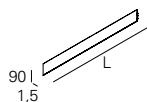

Lmm	CÓDIGO*
1122	90526L0040▲0000
1402	90526L0050▲0000
1682	90526L0060▲0000
1962	90526L0070▲0000
2242	90526L0080▲0000
2522	90526L0090▲0000
2802	90526L0100▲0000

Ángulo vertical (VRT)

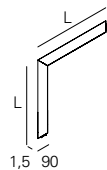

Lmm	CÓDIGO*
631	90526V0040▲0000

Ángulo horizontal (EDGE)

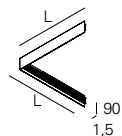

Lmm	CÓDIGO*
601	90526E0040▲0000

Ángulo horizontal (HRZ)

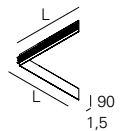

Lmm	CÓDIGO*
602	90526H0040▲0000

PERFIL EXTERIOR

- Para completar el producto, es necesario pedir el perfil interior por separado.
- Para completar una línea, es necesario un Start Kit, cableado de línea continua y kit de unión. Por favor solicítelo por separado.
- La longitud máxima de línea con un solo punto de alimentación es de 30000 mm.

02. Seleccionar perfil interior y difusor



PERFIL INTERIOR | DERECHO / INDIRECTO

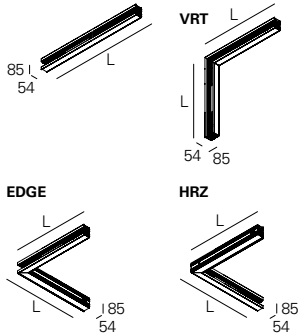

bLINE - Difusor opalino

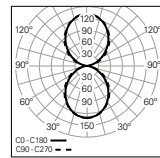

W	lm output	lm/W	Lmm	CÓDIGO*
60	6724	112	1122	90536L004▼W0◆00
70	8405	120	1402	90536L005▼W0◆00
84	10085	120	1682	90536L006▼W◆◆00
104	11766	113	1962	90536L007▼W0◆00
120	13447	112	2242	90536L008▼W0◆00
130	15128	116	2522	90536L009▼W0◆00
140	16809	120	2802	90536L010▼W0◆00
VRT	60	6724	631	90536V004▼W0◆00
EDGE	60	6724	601	90536E004▼W0◆00
HRZ	60	6724	602	90536H004▼W0◆00

*Sustituya los símbolos para completar el código

Fuente de alimentación	▼
HF	E
DALI	H
HF+CD ¹	Q
SWD+CD ²	Y

Emergencia	●
No EM	0
EM 3h (K3) ³	3

Temp. de color	◆
3000K	3
4000K	0
Tunable White ⁴	T

PERFIL INTERIOR | DERECHO

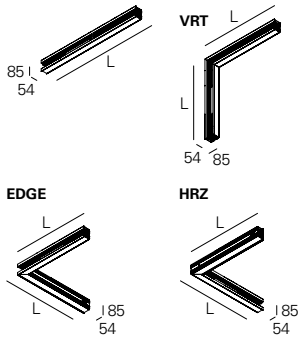

bLINE - Difusor opalino

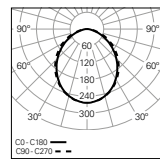

W	lm output	lm/W	Lmm	CÓDIGO*
30	3362	112	1122	90535L004▼W0◆00
35	4202	120	1402	90535L005▼W◆◆00
42	5043	120	1682	90535L006▼W◆◆00
52	5883	113	1962	90535L007▼W◆◆00
60	6724	112	2242	90535L008▼W◆◆00
65	7564	116	2522	90535L009▼W◆◆00
70	8405	120	2802	90535L010▼W◆◆00
VRT	30	3362	631	90535V004▼W0◆00
EDGE	30	3362	601	90535E004▼W0◆00
HRZ	30	3362	602	90535H004▼W0◆00

PERFIL INTERIOR | INDIRECTO

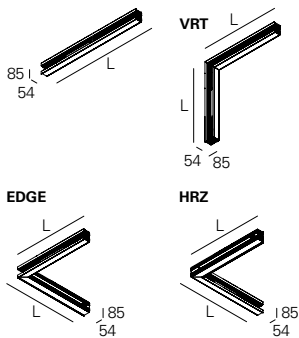

bLINE - Difusor opalino

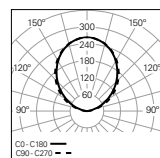

W	lm output	lm/W	Lmm	CÓDIGO*
30	3362	112	1122	90518L004▼W0◆00
35	4202	120	1402	90518L005▼W0◆00
42	5043	120	1682	90518L006▼W0◆00
52	5883	113	1962	90518L007▼W0◆00
60	6724	112	2242	90518L008▼W0◆00
65	7564	116	2522	90518L009▼W0◆00
70	8405	120	2802	90518L010▼W0◆00
VRT	30	3362	631	90518V004▼W0◆00
EDGE	30	3362	601	90518E004▼W0◆00
HRZ	30	3362	602	90518H004▼W0◆00

¹ HF + Doble circuito.

² SwitchDIM + Doble circuito.

³ Preparado para telemando.

⁴ Sólo disponible en las versiones DALI y SWD+CD sin kit de emergencia (No EM).

03. Seleccionar opciones

OPCIONES	Código*
SwitchDIM Tunable White 926600 • En versiones Directas o Indirectas para L ≤ 1682 mm permite controlar máx 20 luminarias, L ≥ 1964 mm permite controlar máx 10 luminarias por cada SwitchDIM Tunable White. • En las versiones Directa / Indirecta para L ≤ 1682 mm permite controlar un máximo de 10 luminarias, L ≥ 1964 mm permite controlar un máximo de 5 luminarias por cada SwitchDIM Tunable White.	
Start kit - Tapas inicio/final 923400♣ • Dos tapas finales incluidas.	
Cableado de línea continua	
• Estándar 3 x 1,5 mm ² 945650 5 x 1,5 mm ² 945750	
• 2 x 1,5 mm² HF+K3 (x1) - L562 - L1682 mm 948000 HF+K3 (x2) - L1964 - L2804 mm 948001	
• 2 x 1,5 mm² + Borna de conexión 5P DALI+K3 (x1) - L562 - L1682 mm 948200 DALI+K3 (x2) - L1964 - L2804 mm 948201	
• 2 x 1,5 mm² + 2 x 0,75 mm² + Borna de conexión 5P K3+TEL (x1) - L562 - L1682 mm 948100 K3+TEL (x2) - L1964 - L2804 mm 948101	
Kit de unión 932120 • Unión galvanizada, tornillos incluidos.	
Módulo ciego L1500 mm 992960♣ L3000 mm 992961♣ • Incluye perfil interior vacío y tapa ciega de aluminio.	
Señalética • Permite grabar signos o textos en el perfil exterior.	
Versión low output • Mediante solicitud.	
Proyectos a medida • Mediante solicitud.	



*Sustituya los símbolos para completar el código

Color	♣
□ Blanco	W
■ Gris	G
■ Negro	B



Detalles del producto







Cómo funciona

1. Perfil exterior

- 1.1 Empotrar
 - 1.2 Trimless
 - 1.3 Superficie
 - 1.4 Suspendida directa
 - 1.5 Suspendida directa / indirecta
-

2. Perfil interior

- 2.1 Simétrico



- 2.2 Asimétrico



3. Difusores

- 3.1 Difusor bLINE
 - 3.2 Difusor bGLARE
 - 3.3 Tapa ciega
 - 3.4 Difusor ASYM
-



77x82 mm



65x82 mm



65x97 mm

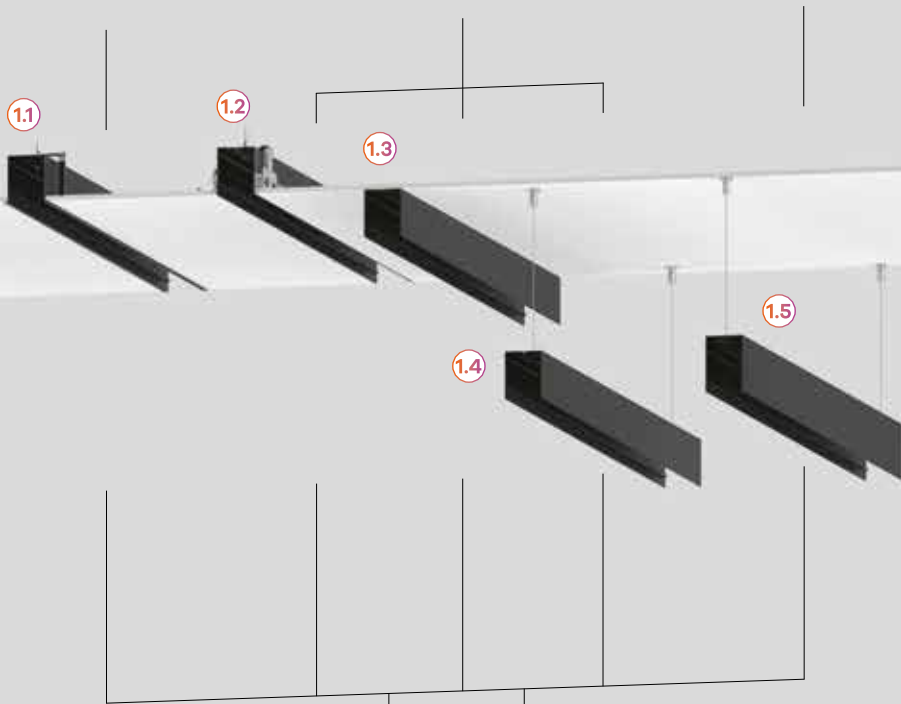

2.1

2.2

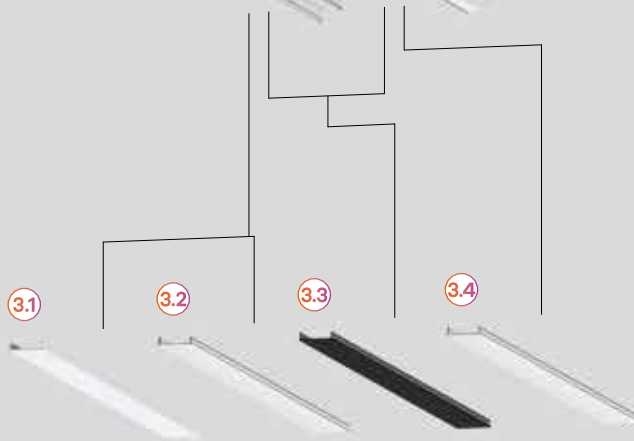





Photo: Ivo Tavares

REBA 65 /T



Características del producto

Cuerpo

Perfil de aluminio extruido

Acabado

Pintado en epoxi-poliéster

Sistema de fijación

Premarco trimless (incluido en el perfil exterior)

Sistema óptico

bGLARE - Difusor microprismático

bLINE - Difusor opalino

ASYM - Difusor Asimétrico

Fuente de luz

LED, RG1, CRI>80, MacAdam Step ≤3

Vida útil del LED

80.000h @ L90, B10, Ta 25°C

Fuente de alimentación

Driver LED 220-240V-50/60Hz incluido

Espesor del techo

Para techos de 10, 13, 15 y 18 mm

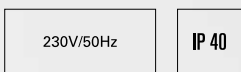
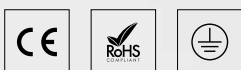

01. Seleccionar perfil exterior

PERFIL EXTERIOR

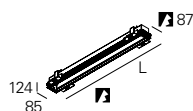

Lmm	W	CÓDIGO*
598	600	90524L0020▲0000
878	880	90524L0030▲0000
1158	1160	90524L0040▲0000
1438	1440	90524L0050▲0000
1718	1720	90524L0060▲0000
2000	2002	90524L0070▲0000
2280	2282	90524L0080▲0000
2560	2562	90524L0090▲0000
2840	2842	90524L0100▲0000



*Sustituya los símbolos para completar el código

Color	▲
□ Blanco	W
■ Gris	G
■ Negro	B

PERFIL EXTERIOR

• Para completar el producto, es necesario pedir el perfil interior por separado.

02. Seleccionar perfil interior y difusor

PERFIL INTERIOR | SIMÉTRICO

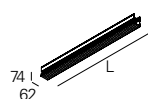

bGLARE - Difusor microprismático

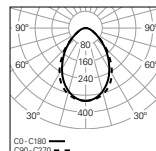

W	lm output	lm/W	Lmm	CÓDIGO*
15	1577	105	562	90502L002▼W0◆00
22	2366	108	842	90502L003▼W0◆00
30	3155	105	1122	90502L004▼W0◆00
35	3944	113	1402	90502L005▼W0◆00
42	4732	113	1682	90502L006▼W0◆00
52	5521	106	1964	90502L007▼W0◆00
60	6310	105	2244	90502L008▼W0◆00
65	7099	109	2524	90502L009▼W0◆00
70	7887	113	2804	90502L010▼W0◆00

*Sustituya los símbolos para completar el código

Fuente de alimentación	▼
HF	E
DALI	H

Emergencia	●
No EM	0
EM 3h (K3) ^{1 2}	3

Temp. de color	◆
3000K	3
4000K	0
Tunable White ³	T

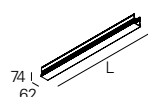

bLINE - Difusor opalino

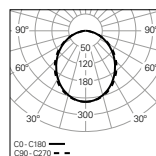

W	lm output	lm/W	Lmm	CÓDIGO*
15	1681	112	562	90501L002▼W0◆00
22	2521	115	842	90501L003▼W0◆00
30	3362	112	1122	90501L004▼W0◆00
35	4202	120	1402	90501L005▼W0◆00
42	5043	120	1682	90501L006▼W0◆00
52	5883	113	1964	90501L007▼W0◆00
60	6724	112	2244	90501L008▼W0◆00
65	7564	116	2524	90501L009▼W0◆00
70	8405	120	2804	90501L010▼W0◆00

PERFIL INTERIOR | ASIMÉTRICO

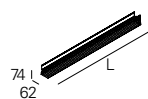

ASYM - Difusor

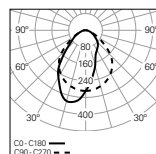

W	lm output	lm/W	Lmm	CÓDIGO*
16	1474	92	562	90504L002▼W0◆00
23	2211	96	842	90504L003▼W0◆00
29	2948	102	1122	90504L004▼W0◆00
36	3685	102	1402	90504L005▼W0◆00
44	4422	101	1682	90504L006▼W0◆00
52	5159	99	1964	90504L007▼W0◆00
58	5896	102	2244	90504L008▼W0◆00
65	6633	102	2524	90504L009▼W0◆00
73	7370	101	2804	90504L010▼W0◆00

¹ Preparado para telemando.

² Versiones DALI + EM 3h (K3) sólo disponibles a partir de L1402 mm.

³ Sólo disponible en versiones DALI sin kit de emergencia (No EM). No disponible en la versión L562 mm.

03. Seleccionar opciones

OPCIONES	Código
SwitchDIM Tunable White • Para $L \leq 1682$ mm permite controlar un máximo de 20 luminarias, $L \geq 1964$ mm permite controlar un máximo de 10 luminarias por cada SwitchDIM Tunable White.	926600
Cable de seguridad en acero L1500 mm	955000
Versión low output • Mediante solicitud.	



Detalles del producto



Perfil exterior



Perfil interno simétrico



Perfil interior asimétrico



Uniformidad de la luz



Premarco trimless



Difusor clip-in

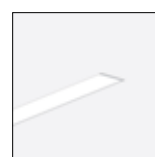

Aplicación trimless



Difusor bGLARE



Difusor bLINE



Difusor ASYM



SwitchDIM Tunable White



REBA 65 /T Line

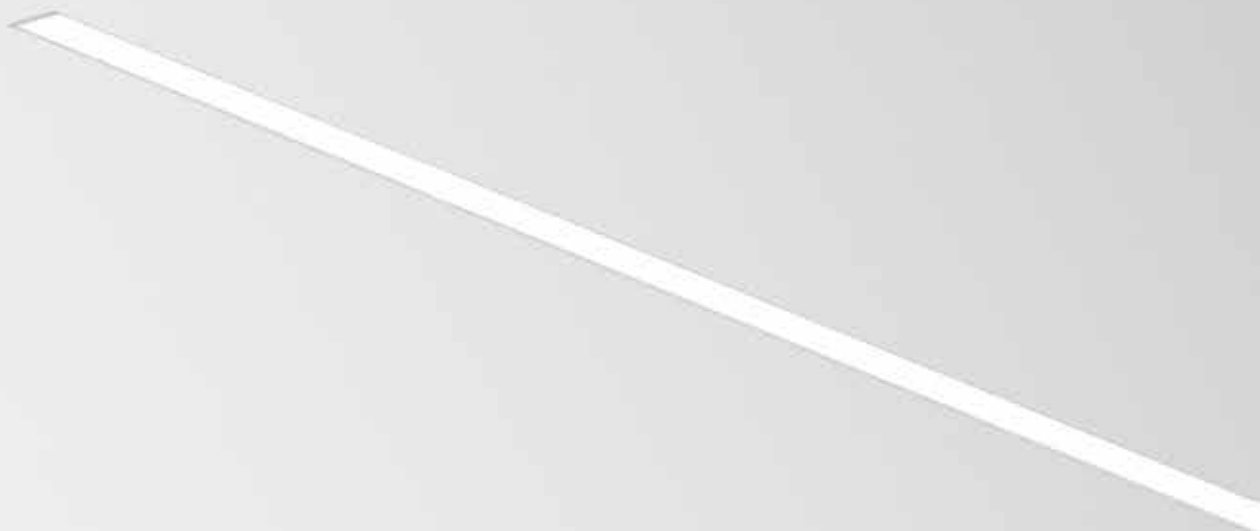

Características del producto

Cuerpo

Perfil de aluminio extruido

Acabado

Pintado en epoxi-poliéster

Sistema de fijación

Premarco trimless (incluido en el perfil exterior)

Sistema óptico

bGLARE - Difusor microprismático

bLINE - Difusor opalino

ASYM - Difusor Asimétrico

Fuente de luz

LED, RG1, CRI>80, MacAdam Step ≤ 3

Vida útil del LED

80.000h @ L90, B10, Ta 25°C

Fuente de alimentación

Driver LED 220-240V-50/60Hz incluido

Espesor del techo

Para techos de 10, 13, 15 y 18 mm

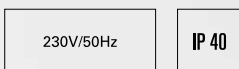

01. Seleccionar perfil exterior



PERFIL EXTERIOR

Inicial / Final (SRT/END)

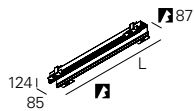

Lmm		CÓDIGO*
580	581	90511L0020▲0083
860	861	90511L0030▲0083
1140	1141	90511L0040▲0083
1420	1421	90511L0050▲0083
1700	1701	90511L0060▲0083
1982	1983	90511L0070▲0083
2262	2263	90511L0080▲0083
2542	2543	90511L0090▲0083
2822	2823	90511L0100▲0083

*Sustituya los símbolos para completar el código

Color	
<input type="checkbox"/> Blanco	W
<input type="checkbox"/> Gris	G
<input type="checkbox"/> Negro	B

Intermedio (MID)

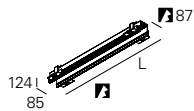

Lmm		CÓDIGO*
562	562	90511L0020▲0000
842	842	90511L0030▲0000
1122	1122	90511L0040▲0000
1402	1402	90511L0050▲0000
1682	1682	90511L0060▲0000
1964	1964	90511L0070▲0000
2244	2244	90511L0080▲0000
2524	2524	90511L0090▲0000
2804	2804	90511L0100▲0000

Ángulo vertical (VRT)

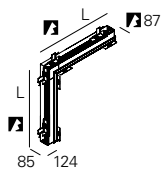

Lmm		CÓDIGO*
559	524	90511V0040▲0000

Ángulo horizontal (HRZ) - Ángulo horizontal (EDGE)

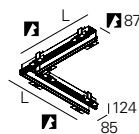

Lmm		CÓDIGO*
618	619	90511H0040▲0000

PERFIL EXTERIOR

- Para completar el producto, es necesario pedir el perfil interior por separado.
- Para completar una línea, es necesario un Start Kit, cableado de línea continua y kit de unión. Por favor solicítelo por separado.
- La longitud máxima de línea con un solo punto de alimentación es de 30000 mm.

02. Seleccionar perfil interior y difusor



PERFIL INTERIOR | SIMÉTRICO

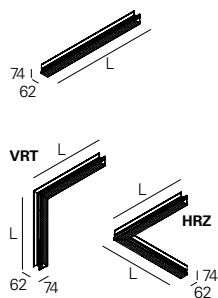

bGLARE - Difusor microprismático

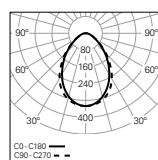

W	lm output	lm/W	Lmm	CÓDIGO*	
15	1577	105	562	90502L002♥W0♦00	
22	2366	108	842	90502L003♥W0♦00	
30	3155	105	1122	90502L004♥W♦♦00	
35	3944	113	1402	90502L005♥W♦♦00	
42	4732	113	1682	90502L006♥W♦♦00	
52	5521	106	1964	90502L007♥W♦♦00	
60	6310	105	2244	90502L008♥W♦♦00	
65	7099	109	2524	90502L009♥W♦♦00	
70	7887	113	2804	90502L010♥W♦♦00	
<hr/>					
VRT	30	3155	105	606	90502V004♥W0♦00
HRZ	30	3155	105	608	90502H004♥W0♦00

bLINE - Difusor opalino

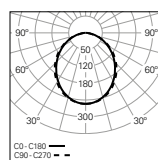

W	lm output	lm/W	Lmm	CÓDIGO*	
15	1681	112	562	90501L002♥W0♦00	
22	2521	115	842	90501L003♥W0♦00	
30	3362	112	1122	90501L004♥W♦♦00	
35	4202	120	1402	90501L005♥W♦♦00	
42	5043	120	1682	90501L006♥W♦♦00	
52	5883	113	1964	90501L007♥W♦♦00	
60	6724	112	2244	90501L008♥W♦♦00	
65	7564	116	2524	90501L009♥W♦♦00	
70	8405	120	2804	90501L010♥W♦♦00	
<hr/>					
VRT	30	3362	112	606	90501V004♥W0♦00
HRZ	30	3362	112	608	90501H004♥W0♦00

PERFIL INTERIOR | ASIMÉTRICO

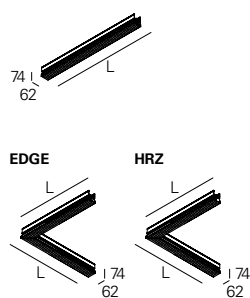

ASYM - Difusor

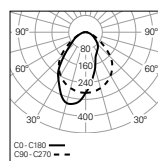

W	lm output	lm/W	Lmm	CÓDIGO*	
16	1474	92	562	90504L002♥W0♦00	
23	2211	96	842	90504L003♥W0♦00	
29	2948	102	1122	90504L004♥W♦♦00	
36	3685	102	1402	90504L005♥W♦♦00	
44	4422	101	1682	90504L006♥W♦♦00	
52	5159	99	1964	90504L007♥W♦♦00	
58	5896	102	2244	90504L008♥W♦♦00	
65	6633	102	2524	90504L009♥W♦♦00	
73	7370	101	2804	90504L010♥W♦♦00	
<hr/>					
EDGE	29	2948	102	606	90504E004♥W0♦00
HRZ	29	2948	102	608	90504H004♥W0♦00

*Sustituya los símbolos para completar el código

Fuente de alimentación ♥
HF E
DALI H

Emergencia ●
No EM 0
EM 3h (K3) ^{1 2} 3

Temp. de color ♦
3000K 3
4000K 0
Tunable White ³ T

¹ Preparado para telemando.

² Versiones DALI + EM 3h (K3) sólo disponibles a partir de L1402 mm.

³ Sólo disponible en versiones DALI sin kit de emergencia (No EM). No disponible en la versión L562 mm.

03. Seleccionar opciones

OPCIONES	Código*
SwitchDIM Tunable White • Para L ≤ 1682 mm permite controlar un máximo de 20 luminarias, L ≥ 1964 mm permite controlar un máximo de 10 luminarias por cada SwitchDIM Tunable White.	926600
Start kit - Tapas inicio/final • Dos tapas finales incluidas.	82  923500♣ 65 3
Cableado de línea continua • Estándar 3 x 1,5 mm ² 5 x 1,5 mm ²	945650 945750
• 2 x 1,5 mm² HF+K3 (x1) - L562 - L1682 mm HF+K3 (x2) - L1964 - L2804 mm	948000 948001
• 2 x 1,5 mm² + Borna de conexión 5P DALI+K3 (x1) - L562 - L1682 mm DALI+K3 (x2) - L1964 - L2804 mm	948200 948201
• 2 x 1,5 mm² + 2 x 0,75 mm² + Borna de conexión 5P K3+TEL (x1) - L562 - L1682 mm K3+TEL (x2) - L1964 - L2804 mm	948100 948101
Kit de unión • Unión galvanizada, tornillos incluidos.	932220
Módulo ciego L1500 mm L3000 mm • Incluye perfil interior vacío y tapa ciega de aluminio.	993060♣ 993061♣
Cable de seguridad en acero L1500 mm	955000
Versión low output • Mediante solicitud.	
Proyectos a medida • Mediante solicitud.	



*Sustituya los símbolos para completar el código

Color	♣
<input type="checkbox"/> Blanco	W
<input type="checkbox"/> Gris	G
<input type="checkbox"/> Negro	B



Detalles del producto



Perfil exterior



Perfil interno simétrico



Perfil interior asimétrico



Uniformidad de la luz

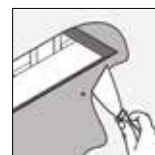

Premarco trimless



Difusor clip-in



Ángulo vertical



Ángulo horizontal



Aplicación trimless



Difusor bGLARE



Difusor bLINE



Difusor ASYM



SwitchDIM Tunable White



Start kit



Photo: Ivo Tavares



Photo: Ivo Tavares

REBA 65 /E



Características del producto

Cuerpo

Perfil de aluminio extruido

Acabado

Pintado en epoxi-poliéster

Sistema de fijación

Niveladores

Sistema óptico

bGLARE - Difusor microprismático

bLINE - Difusor opalino

ASYM - Difusor Asimétrico

Fuente de luz

LED, RG1, CRI>80, MacAdam Step ≤3

Vida útil del LED

80.000h @ L90, B10, Ta 25°C

Fuente de alimentación

Driver LED 220-240V-50/60Hz incluido

Espesor del techo

Para techos entre 1-25 mm

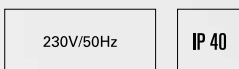

01. Seleccionar perfil exterior

PERFIL EXTERIOR

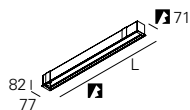

Lmm	f3	CÓDIGO*
590	580	90525L0020▲0000
870	860	90525L0030▲0000
1150	1140	90525L0040▲0000
1430	1420	90525L0050▲0000
1710	1700	90525L0060▲0000
1992	1982	90525L0070▲0000
2272	2262	90525L0080▲0000
2552	2542	90525L0090▲0000
2832	2822	90525L0100▲0000



*Sustituya los símbolos para completar el código

Color	▲
□ Blanco	W
■ Gris	G
■ Negro	B

PERFIL EXTERIOR

• Para completar el producto, es necesario pedir el perfil interior por separado.

02. Seleccionar perfil interior y difusor

PERFIL INTERIOR | SIMÉTRICO

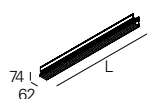

bGLARE - Difusor microprismático

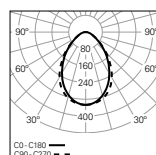

W	lm output	lm/W	Lmm	CÓDIGO*
15	1577	105	562	90502L002▼W0◆00
22	2366	108	842	90502L003▼W0◆00
30	3155	105	1122	90502L004▼W0◆00
35	3944	113	1402	90502L005▼W0◆00
42	4732	113	1682	90502L006▼W0◆00
52	5521	106	1964	90502L007▼W0◆00
60	6310	105	2244	90502L008▼W0◆00
65	7099	109	2524	90502L009▼W0◆00
70	7887	113	2804	90502L010▼W0◆00

bLINE - Difusor opalino

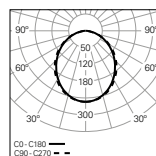

W	lm output	lm/W	Lmm	CÓDIGO*
15	1681	112	562	90501L002▼W0◆00
22	2521	115	842	90501L003▼W0◆00
30	3362	112	1122	90501L004▼W0◆00
35	4202	120	1402	90501L005▼W0◆00
42	5043	120	1682	90501L006▼W0◆00
52	5883	113	1964	90501L007▼W0◆00
60	6724	112	2244	90501L008▼W0◆00
65	7564	116	2524	90501L009▼W0◆00
70	8405	120	2804	90501L010▼W0◆00

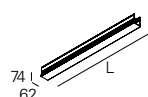

PERFIL INTERIOR | ASIMÉTRICO

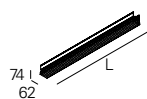

ASYM - Difusor

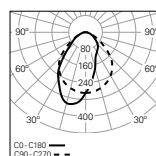

W	lm output	lm/W	Lmm	CÓDIGO*
16	1474	92	562	90504L002▼W0◆00
23	2211	96	842	90504L003▼W0◆00
29	2948	102	1122	90504L004▼W0◆00
36	3685	102	1402	90504L005▼W0◆00
44	4422	101	1682	90504L006▼W0◆00
52	5159	99	1964	90504L007▼W0◆00
58	5896	102	2244	90504L008▼W0◆00
65	6633	102	2524	90504L009▼W0◆00
73	7370	101	2804	90504L010▼W0◆00



*Sustituya los símbolos para completar el código

Fuente de alimentación	▼
HF	E
DALI	H

Emergencia	●
No EM	0
EM 3h (K3) ^{1 2}	3

Temp. de color	◆
3000K	3
4000K	0
Tunable White ³	T

¹ Preparado para telemando.

² Versiones DALI + EM 3h (K3) sólo disponibles a partir de L1402 mm.

³ Sólo disponible en versiones DALI sin kit de emergencia (No EM). No disponible en la versión L562 mm.

03. Seleccionar opciones

OPCIONES	Código
SwitchDIM Tunable White • Para $L \leq 1682$ mm permite controlar un máximo de 20 luminarias, $L \geq 1964$ mm permite controlar un máximo de 10 luminarias por cada SwitchDIM Tunable White.	926600
Cable de seguridad en acero L1500 mm	955000
Versión low output • Mediante solicitud.	



Detalles del producto



Perfil exterior



Nivelador



Perfil interno simétrico

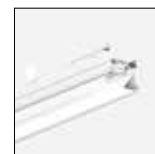

Perfil interior asimétrico



Uniformidad de la luz



Difusor clip-in



Aplicación de empotrar



Difusor bGLARE



Difusor bLINE



Difusor ASYM



SwitchDIM
Tunable White



REBA 65 /E Line

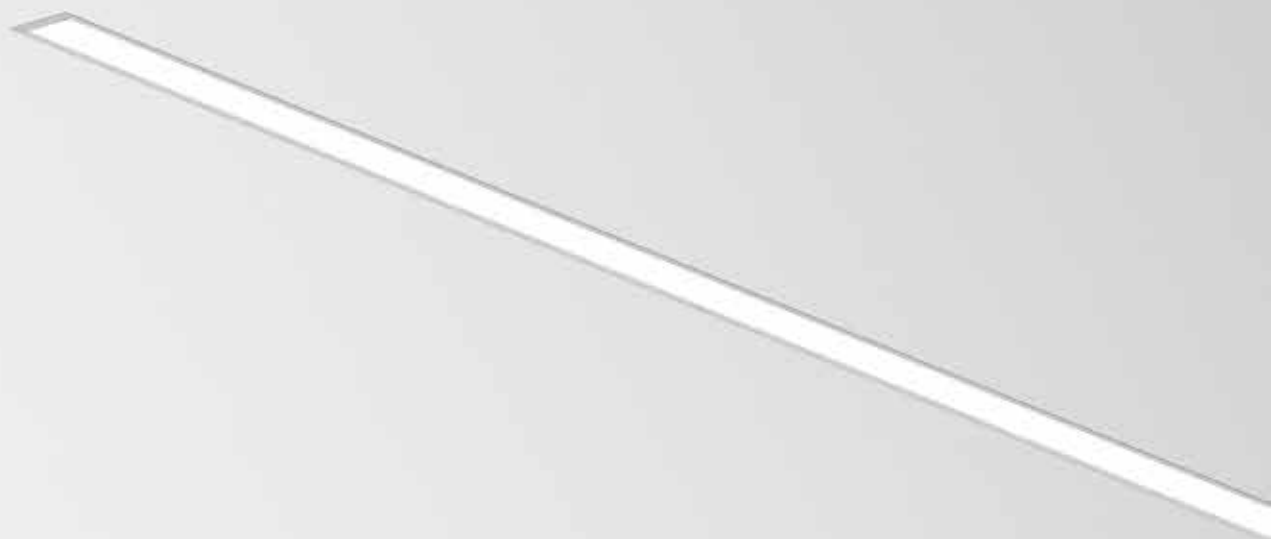

Características del producto

Cuerpo

Perfil de aluminio extruido

Acabado

Pintado en epoxi-poliéster

Sistema de fijación

Niveladores

Sistema óptico

bGLARE - Difusor microprismático

bLINE - Difusor opalino

ASYM - Difusor Asimétrico

Fuente de luz

LED, RG1, CRI>80, MacAdam Step ≤3

Vida útil del LED

80.000h @ L90, B10, Ta 25°C

Fuente de alimentación

Driver LED 220-240V-50/60Hz incluido

Espesor del techo

Para techos entre 1-25 mm

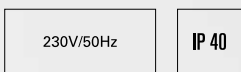

01. Seleccionar perfil exterior



PERFIL EXTERIOR

Inicial / Final (SRT/END)

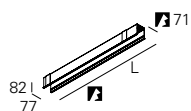

Lmm		CÓDIGO*
567	568	90510L0020▲0083
847	848	90510L0030▲0083
1127	1128	90510L0040▲0083
1407	1408	90510L0050▲0083
1687	1688	90510L0060▲0083
1969	1970	90510L0070▲0083
2249	2250	90510L0080▲0083
2529	2530	90510L0090▲0083
2809	2810	90510L0100▲0083

*Sustituya los símbolos para completar el código

Color	▲
□ Blanco	W
■ Gris	G
■ Negro	B

Intermedio (MID)

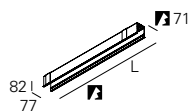

Lmm		CÓDIGO*
562	562	90510L0020▲0000
842	842	90510L0030▲0000
1122	1122	90510L0040▲0000
1402	1402	90510L0050▲0000
1682	1682	90510L0060▲0000
1964	1964	90510L0070▲0000
2244	2244	90510L0080▲0000
2524	2524	90510L0090▲0000
2804	2804	90510L0100▲0000

Ángulo vertical (VRT)

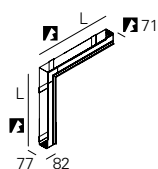

Lmm		CÓDIGO*
606	526	90510V0040▲0000

Ángulo horizontal (HRZ) - Ángulo horizontal (EDGE)

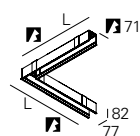

Lmm		CÓDIGO*
614	611	90510H0040▲0000

PERFIL EXTERIOR

- Para completar el producto, es necesario pedir el perfil interior por separado.
- Para completar una línea, es necesario un Start Kit, cableado de línea continua y kit de unión. Por favor solicítelo por separado.
- Las dimensiones no incluyen Start Kit. Para completar la dimensión empotrada de la línea, incremente 6 mm a la longitud de corte.
- La longitud máxima de línea con un solo punto de alimentación es de 30000 mm.

02. Seleccionar perfil interior y difusor



PERFIL INTERIOR | SIMÉTRICO

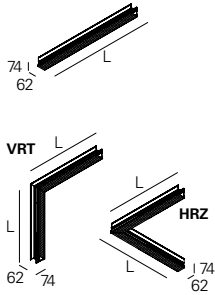

bGLARE - Difusor microprismático

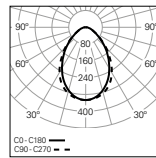

W	lm output	lm/W	Lmm	CÓDIGO*	
15	1577	105	562	90502L002♥W0♦00	
22	2366	108	842	90502L003♥W0♦00	
30	3155	105	1122	90502L004♥W♦♦00	
35	3944	113	1402	90502L005♥W♦♦00	
42	4732	113	1682	90502L006♥W♦♦00	
52	5521	106	1964	90502L007♥W♦♦00	
60	6310	105	2244	90502L008♥W♦♦00	
65	7099	109	2524	90502L009♥W♦♦00	
70	7887	113	2804	90502L010♥W♦♦00	
<hr/>					
VRT	30	3155	105	606	90502V004♥W0♦00
HRZ	30	3155	105	608	90502H004♥W0♦00

bLINE - Difusor opalino

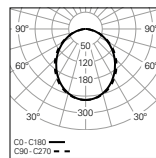

W	lm output	lm/W	Lmm	CÓDIGO*	
15	1681	112	562	90501L002♥W0♦00	
22	2521	115	842	90501L003♥W0♦00	
30	3362	112	1122	90501L004♥W♦♦00	
35	4202	120	1402	90501L005♥W♦♦00	
42	5043	120	1682	90501L006♥W♦♦00	
52	5883	113	1964	90501L007♥W♦♦00	
60	6724	112	2244	90501L008♥W♦♦00	
65	7564	116	2524	90501L009♥W♦♦00	
70	8405	120	2804	90501L010♥W♦♦00	
<hr/>					
VRT	30	3362	112	606	90501V004♥W0♦00
HRZ	30	3362	112	608	90501H004♥W0♦00

PERFIL INTERIOR | ASIMÉTRICO

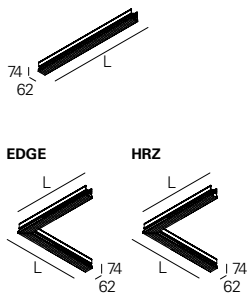

ASYM - Difusor

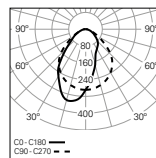

W	lm output	lm/W	Lmm	CÓDIGO*	
16	1474	92	562	90504L002♥W0♦00	
23	2211	96	842	90504L003♥W0♦00	
29	2948	102	1122	90504L004♥W♦♦00	
36	3685	102	1402	90504L005♥W♦♦00	
44	4422	101	1682	90504L006♥W♦♦00	
52	5159	99	1964	90504L007♥W♦♦00	
58	5896	102	2244	90504L008♥W♦♦00	
65	6633	102	2524	90504L009♥W♦♦00	
73	7370	101	2804	90504L010♥W♦♦00	
<hr/>					
EDGE	29	2948	102	606	90504E004♥W0♦00
HRZ	29	2948	102	608	90504H004♥W0♦00

*Sustituya los símbolos para completar el código

Fuente de alimentación ♥
HF E
DALI H

Emergencia ●
No EM 0
EM 3h (K3) ^{1 2} 3

Temp. de color ♦
3000K 3
4000K 0
Tunable White ³ T

¹ Preparado para telemando.

² Versiones DALI + EM 3h (K3) sólo disponibles a partir de L1402 mm.

³ Sólo disponible en versiones DALI sin kit de emergencia (No EM). No disponible en la versión L562 mm.

03. Seleccionar opciones

OPCIONES	Código*
SwitchDIM Tunable White • Para L ≤ 1682 mm permite controlar un máximo de 20 luminarias, L ≥ 1964 mm permite controlar un máximo de 10 luminarias por cada SwitchDIM Tunable White.	926600
Start kit - Tapas inicio/final • Dos tapas finales incluidas.	 923600♣
Cableado de línea continua • Estándar 3 x 1,5 mm ² 5 x 1,5 mm ²	945650 945750
• 2 x 1,5 mm² HF+K3 (x1) - L562 - L1682 mm HF+K3 (x2) - L1964 - L2804 mm	948000 948001
• 2 x 1,5 mm² + Borna de conexión 5P DALI+K3 (x1) - L562 - L1682 mm DALI+K3 (x2) - L1964 - L2804 mm	948200 948201
• 2 x 1,5 mm² + 2 x 0,75 mm² + Borna de conexión 5P K3+TEL (x1) - L562 - L1682 mm K3+TEL (x2) - L1964 - L2804 mm	948100 948101
Kit de unión • Unión galvanizada, tornillos incluidos.	932200
Módulo ciego L1500 mm L3000 mm • Incluye perfil interior vacío y tapa ciega de aluminio.	993020♣ 993021♣
Cable de seguridad en acero L1500 mm	955000
Versión low output • Mediante solicitud.	
Proyectos a medida • Mediante solicitud.	



*Sustituya los símbolos para completar el código

Color	♣
□ Blanco	W
■ Gris	G
■ Negro	B



Detalles del producto



Perfil exterior



Perfil interno simétrico



Perfil interior asimétrico

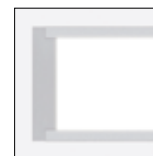

Uniformidad de la luz



Nivelador



Difusor clip-in



Ángulo vertical



Ángulo horizontal



Aplicación de empotrar



Difusor bGLARE



Difusor bLINE



Difusor ASYM



SwitchDIM Tunable White



Start kit





REBA 65



Características del producto

Cuerpo

Perfil de aluminio extruido

Acabado

Pintado en epoxi-poliéster

Sistema óptico

bGLARE - Difusor microprismático

bLINE - Difusor opalino

ASYM - Difusor Asimétrico

Fuente de luz

LED, RG1, CRI>80, MacAdam Step ≤ 3

Vida útil del LED

80.000h @ L90, B10, Ta 25°C

Fuente de alimentación

Driver LED 220-240V-50/60Hz incluido



01. Seleccionar perfil exterior

PERFIL EXTERIOR

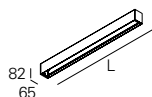

Lmm	CÓDIGO*
578	90522L0020♣0000
858	90522L0030♣0000
1138	90522L0040♣0000
1418	90522L0050♣0000
1698	90522L0060♣0000
1980	90522L0070♣0000
2260	90522L0080♣0000
2540	90522L0090♣0000
2820	90522L0100♣0000



*Sustituya los símbolos para completar el código

Color	♣
□ Blanco	W
■ Gris	G
■ Negro	B

PERFIL EXTERIOR

- Para completar el producto, es necesario pedir el perfil interior por separado.
- Para la versión suspendida, es necesario pedir suspensiones, cable y base de alimentación por separado.

02. Seleccionar perfil interior y difusor

PERFIL INTERIOR | SIMÉTRICO

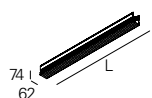

bGLARE - Difusor microprismático

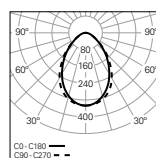

W	lm output	lm/W	Lmm	CÓDIGO*
15	1577	105	562	90502L002♥W0♦00
22	2366	108	842	90502L003♥W0♦00
30	3155	105	1122	90502L004♥W♦♦00
35	3944	113	1402	90502L005♥W♦♦00
42	4732	113	1682	90502L006♥W♦♦00
52	5521	106	1964	90502L007♥W♦♦00
60	6310	105	2244	90502L008♥W♦♦00
65	7099	109	2524	90502L009♥W♦♦00
70	7887	113	2804	90502L010♥W♦♦00

*Sustituya los símbolos para completar el código

Fuente de alimentación	♥
HF	E
DALI	H

Emergencia	●
No EM	0
EM 3h (K3) ^{1,2}	3

Temp. de color	♦
3000K	3
4000K	0
Tunable White ³	T

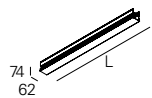

bLINE - Difusor opalino

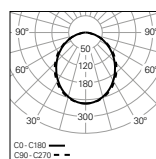

W	lm output	lm/W	Lmm	CÓDIGO*
15	1681	112	562	90501L002♥W0♦00
22	2521	115	842	90501L003♥W0♦00
30	3362	112	1122	90501L004♥W♦♦00
35	4202	120	1402	90501L005♥W♦♦00
42	5043	120	1682	90501L006♥W♦♦00
52	5883	113	1964	90501L007♥W♦♦00
60	6724	112	2244	90501L008♥W♦♦00
65	7564	116	2524	90501L009♥W♦♦00
70	8405	120	2804	90501L010♥W♦♦00

PERFIL INTERIOR | ASIMÉTRICO

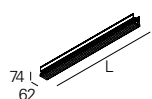

ASYM - Difusor

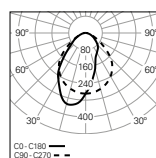





W	lm output	lm/W	Lmm	CÓDIGO*
16	1474	92	562	90504L002♥W0♦00
23	2211	96	842	90504L003♥W0♦00
29	2948	102	1122	90504L004♥W♦♦00
36	3685	102	1402	90504L005♥W♦♦00
44	4422	101	1682	90504L006♥W♦♦00
52	5159	99	1964	90504L007♥W♦♦00
58	5896	102	2244	90504L008♥W♦♦00
65	6633	102	2524	90504L009♥W♦♦00
73	7370	101	2804	90504L010♥W♦♦00

¹ Preparado para telemando.

² Versiones DALI + EM 3h (K3) sólo disponibles a partir de L1402 mm.

³ Sólo disponible en versiones DALI sin kit de emergencia (No EM). No disponible en la versión L562 mm.

03. Seleccionar opciones

OPCIONES	Código*
SwitchDIM Tunable White	926600
<ul style="list-style-type: none"> • Para L ≤ 1682 mm permite controlar un máximo de 20 luminarias, L ≥ 1964 mm permite controlar un máximo de 10 luminarias por cada SwitchDIM Tunable White. 	
Suspensión	
S5 L1500 mm (x1)	910408
S5 L1500 mm (x2)	910409
S5 L3000 mm (x1)	910419
S5 L3000 mm (x2)	910412
S5 L6000 mm (x1)	910420
S5 L6000 mm (x2)	910421
Cable de alimentación transparente	
L1500 mm - 3 x 0,75 mm ²	940400
L1500 mm - 5 x 0,75 mm ²	940500
L1500 mm - 7 x 0,75 mm ²	940600
L3000 mm - 3 x 0,75 mm ²	940401
L3000 mm - 5 x 0,75 mm ²	940501
L3000 mm - 7 x 0,75 mm ²	940601
L6000 mm - 3 x 0,75 mm ²	940402
L6000 mm - 5 x 0,75 mm ²	940507
L6000 mm - 7 x 0,75 mm ²	940602
<ul style="list-style-type: none"> • Para la opción DALI con kit de emergencia teledomable, es necesario solicitar 2 cables de alimentación de 5 x 0,75 mm². 	
Base cuadrada	
Superficie T25	45  100 978610♣
Superficie T29 (DALI+K3)	978611♣
Empotrar T7	 Ø70 35  90 971400♣
Empotrar T59 (DALI+K3)	971410♣
Base circular	
Superficie T24	45  Ø95 978600♣
Superficie T26 (DALI+K3)	978601♣
Empotrar T5	 Ø70 33  Ø90 971300♣
Empotrar T27 (DALI+K3)	978700♣
Versión low output	
<ul style="list-style-type: none"> • Mediante solicitud. 	



*Sustituya los símbolos para completar el código

Color ♣
 Blanco W
 Negro B



Detalles del producto





Architects: Gleason
Photo: António Chaves

REBA 65 Line



Características del producto

Cuerpo

Perfil de aluminio extruido

Acabado

Pintado en epoxi-poliéster

Sistema óptico

bGLARE - Difusor microprismático

bLINE - Difusor opalino

ASYM - Difusor Asimétrico

Fuente de luz

LED, RG1, CRI>80, MacAdam Step ≤ 3

Vida útil del LED

80.000h @ L90, B10, Ta 25°C

Fuente de alimentación

Driver LED 220-240V-50/60Hz incluido



230V/50Hz

IP 40

ASYM
850°C

bGLARE
850°C

bLINE
960°C

01. Seleccionar perfil exterior



PERFIL EXTERIOR

Inicial / Final (SRT/END)

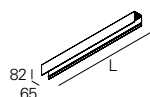

Lmm	CÓDIGO*
567	90509L0020▲0083
847	90509L0030▲0083
1127	90509L0040▲0083
1407	90509L0050▲0083
1687	90509L0060▲0083
1969	90509L0070▲0083
2249	90509L0080▲0083
2529	90509L0090▲0083
2809	90509L0100▲0083

*Sustituya los símbolos para completar el código

Color	▲
□ Blanco	W
■ Gris	G
■ Negro	B

Intermedio (MID)

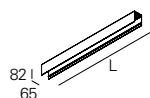

Lmm	CÓDIGO*
562	90509L0020▲0000
842	90509L0030▲0000
1122	90509L0040▲0000
1402	90509L0050▲0000
1682	90509L0060▲0000
1964	90509L0070▲0000
2244	90509L0080▲0000
2524	90509L0090▲0000
2804	90509L0100▲0000

Ángulo vertical (VRT)

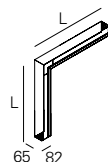

Lmm	CÓDIGO*
606	90509V0040▲0000

Ángulo horizontal (HRZ) - Ángulo horizontal (EDGE)

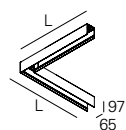

Lmm	CÓDIGO*
608	90509H0040▲0000

PERFIL EXTERIOR

- Para completar el producto, es necesario pedir el perfil interior por separado.
- Para la versión suspendida, es necesario pedir suspensiones, cable y base de alimentación por separado.
- Para completar una línea, es necesario un Start Kit, cableado de línea continua y kit de unión. Por favor solicítelo por separado.
- Las dimensiones no incluyen el star kit. Incremente 6 mm a la longitud para completar la línea.
- La longitud máxima de línea con un solo punto de alimentación es de 30000 mm.

02. Seleccionar perfil interior y difusor



PERFIL INTERIOR | SIMÉTRICO

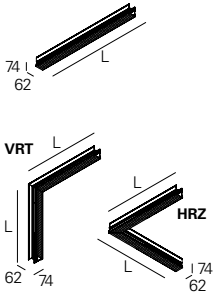

bGLARE - Difusor microprismático

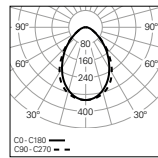

W	lm output	lm/W	Lmm	CÓDIGO*	
15	1577	105	562	90502L002♥W0♦00	
22	2366	108	842	90502L003♥W0♦00	
30	3155	105	1122	90502L004♥W♦♦00	
35	3944	113	1402	90502L005♥W♦♦00	
42	4732	113	1682	90502L006♥W♦♦00	
52	5521	106	1964	90502L007♥W♦♦00	
60	6310	105	2244	90502L008♥W♦♦00	
65	7099	109	2524	90502L009♥W♦♦00	
70	7887	113	2804	90502L010♥W♦♦00	
<hr/>					
VRT	30	3155	105	606	90502V004♥W0♦00
HRZ	30	3155	105	608	90502H004♥W0♦00

bLINE - Difusor opalino

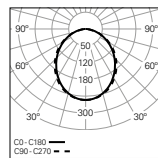

W	lm output	lm/W	Lmm	CÓDIGO*	
15	1681	112	562	90501L002♥W0♦00	
22	2521	115	842	90501L003♥W0♦00	
30	3362	112	1122	90501L004♥W♦♦00	
35	4202	120	1402	90501L005♥W♦♦00	
42	5043	120	1682	90501L006♥W♦♦00	
52	5883	113	1964	90501L007♥W♦♦00	
60	6724	112	2244	90501L008♥W♦♦00	
65	7564	116	2524	90501L009♥W♦♦00	
70	8405	120	2804	90501L010♥W♦♦00	
<hr/>					
VRT	30	3362	112	606	90501V004♥W0♦00
HRZ	30	3362	112	608	90501H004♥W0♦00

PERFIL INTERIOR | ASIMÉTRICO

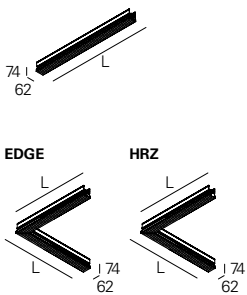

ASYM - Difusor

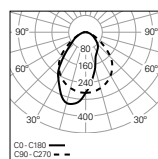

W	lm output	lm/W	Lmm	CÓDIGO*	
16	1474	92	562	90504L002♥W0♦00	
23	2211	96	842	90504L003♥W0♦00	
29	2948	102	1122	90504L004♥W♦♦00	
36	3685	102	1402	90504L005♥W♦♦00	
44	4422	101	1682	90504L006♥W♦♦00	
52	5159	99	1964	90504L007♥W♦♦00	
58	5896	102	2244	90504L008♥W♦♦00	
65	6633	102	2524	90504L009♥W♦♦00	
73	7370	101	2804	90504L010♥W♦♦00	
<hr/>					
EDGE	29	2948	102	606	90504E004♥W0♦00
HRZ	29	2948	102	608	90504H004♥W0♦00

*Sustituya los símbolos para completar el código

Fuente de alimentación ♥
HF E
DALI H

Emergencia ●
No EM 0
EM 3h (K3) ^{1 2} 3

Temp. de color ♦
3000K 3
4000K 0
Tunable White ³ T

¹ Preparado para telemando.

² Versiones DALI + EM 3h (K3) sólo disponibles a partir de L1402 mm.

³ Sólo disponible en versiones DALI sin kit de emergencia (No EM). No disponible en la versión L562 mm.

03. Seleccionar opciones

OPCIONES	Código*
SwitchDIM Tunable White • Para L ≤ 1682 mm permite controlar un máximo de 20 luminarias, L ≥ 1964 mm permite controlar un máximo de 10 luminarias por cada SwitchDIM Tunable White.	926600
Start kit - Tapas inicio/final • Dos tapas finales incluidas.	82 923500▲ 65 3
Cableado de línea continua • Estándar 3 x 1,5 mm ² 5 x 1,5 mm ²	945650 945750
• 2 x 1,5 mm² HF+K3 (x1) - L562 - L1682 mm HF+K3 (x2) - L1964 - L2804 mm	948000 948001
• 2 x 1,5 mm² + Borna de conexión 5P DALI+K3 (x1) - L562 - L1682 mm DALI+K3 (x2) - L1964 - L2804 mm	948200 948201
• 2 x 1,5 mm² + 2 x 0,75 mm² + Borna de conexión 5P K3+TEL (x1) - L562 - L1682 mm K3+TEL (x2) - L1964 - L2804 mm	948100 948101
Kit de unión • Unión galvanizada, tornillos incluidos.	932200
Suspensión S5 L1500 mm (x1) S5 L1500 mm (x2) S5 L3000 mm (x1) S5 L3000 mm (x2) S5 L6000 mm (x1) S5 L6000 mm (x2)	910408 910409 910419 910412 910420 910421
Cable de alimentación transparente 3 x 1,5 mm ² 5 x 1,5 mm ² 7 x 1,5 mm ² • Para la opción DALI con kit de emergencia telemandable, es necesario solicitar 2 cables de alimentación de 5 x 1,5 mm ² .	94030▲ 94000▲ 94010▲
Base cuadrada³ Superficie T25 Superficie T29 (DALI+K3) Empotrar T7 Empotrar T59 (DALI+K3)	45 100 978610▲ 978611▲ Ø70 35 90 971400▲ 971410▲
Base circular³ Superficie T24 Superficie T26 (DALI+K3) Empotrar T5 Empotrar T27 (DALI+K3)	45 Ø95 978600▲ 978601▲ Ø70 33 Ø90 971300▲ 978700▲
Módulo ciego L1500 mm L3000 mm • Incluye perfil interior vacío y tapa ciega de aluminio.	993000▲ 993001▲
Versión low output • Mediante solicitud.	
Proyectos a medida • Mediante solicitud.	



*Sustituya los símbolos para completar el código

Longitud	▲
L1500 mm	0
L3000 mm	1
L6000 mm	2

Color ³	▲
□ Blanco	W
■ Gris	G
■ Negro	B



Detalles del producto



Perfil exterior

Perfil interno simétrico

Perfil interior asimétrico



Tapas sin tornillos visibles

Unión sin salidas de luz

Uniformidad de la luz



Suspensión

Difusor clip-in

Ángulo vertical

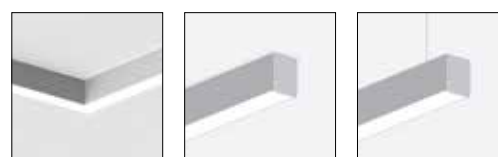

Ángulo horizontal

Aplicación de superficie

Aplicación suspendida



Difusor bGLARE

Difusor bLINE

Difusor ASYM



SwitchDIM Tunable White

Start kit

Base cuadrada



Base circular

³ Bases de techo solo están disponibles en blanco o negro.





REBA 65 D/I



Características del producto

Cuerpo

Perfil de aluminio extruido

Acabado

Pintado en epoxi-poliéster

Sistema óptico

bGLARE - Difusor microprismático

bLINE - Difusor opalino

ASYM - Difusor Asimétrico

Fuente de luz

LED, RG1, CRI>80, MacAdam Step ≤3

Vida útil del LED

80.000h @ L90, B10, Ta 25°C

Fuente de alimentación

Driver LED 220-240V-50/60Hz incluido



230V/50Hz

IP 40

ASYM
850°C

bGLARE
850°C

bLINE
960°C

01. Seleccionar perfil exterior

PERFIL EXTERIOR

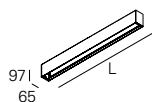

Lmm	CÓDIGO*
1138	90537L0040▲0000
1418	90537L0050▲0000
1698	90537L0060▲0000
2260	90537L0080▲0000
2540	90537L0090▲0000
2820	90537L0100▲0000



*Sustituya los símbolos para completar el código

Color	Color
□ Blanco	W
■ Gris	G
■ Negro	B

PERFIL EXTERIOR

- Difusor de la parte indirecta incluido en el producto.
- Para completar el producto es necesario añadir perfil interior, suspensión, cable de alimentación transparente y base de techo. Por favor solicítelo por separado.

02. Seleccionar perfil interior y difusor

PERFIL INTERIOR | SIMÉTRICO

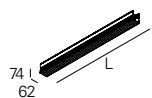

bGLARE - Difusor micropismático (60%/40%)

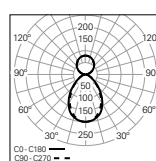

W	lm output	lm/W	Lmm	CÓDIGO*
52	5250	101	1122	90532L004▼W0♦00
65	6749	104	1402	90532L005▼W0♦00
77	8249	107	1682	90532L006▼W0♦00
102	10499	103	2244	90532L008▼W0♦00
117	11999	103	2524	90532L009▼W0♦00
130	13499	104	2804	90532L010▼W0♦00

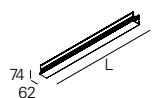

bLINE - Difusor opalino (60%/40%)

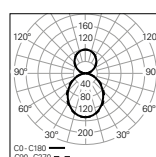

W	lm output	lm/W	Lmm	CÓDIGO*
52	5340	103	1122	90531L004▼W0♦00
65	6866	106	1402	90531L005▼W0♦00
77	8392	109	1682	90531L006▼W0♦00
102	10680	105	2244	90531L008▼W0♦00
117	12206	104	2524	90531L009▼W0♦00
130	13732	106	2804	90531L010▼W0♦00



*Sustituya los símbolos para completar el código

Fuente de alimentación	Fuente de alimentación
HF	E
DALI	H
HF+CD ¹	Q
SWD+CD ²	Y

Emergencia	Emergencia
No EM	0
EM 3h (K3) ³	3

Temp. de color	Temp. de color
3000K	3
4000K	0
Tunable White ⁴	T

PERFIL INTERIOR | ASIMÉTRICO

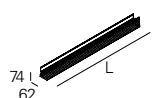

ASYM - Difusor (60%/40%)

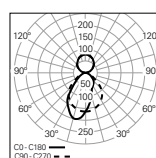

W	lm output	lm/W	Lmm	CÓDIGO*
51	4888	96	1122	90534L004▼W0♦00
66	6284	95	1402	90534L005▼W0♦00
79	7680	97	1682	90534L006▼W0♦00
100	9775	98	2244	90534L008▼W0♦00
117	11172	95	2524	90534L009▼W0♦00
133	12568	94	2804	90534L010▼W0♦00

¹ HF + Doble circuito.

² SwitchDIM + Doble circuito.

³ Preparado para telemando.

⁴ Sólo disponible en las versiones DALI y SWD+CD sin kit de emergencia (No EM).

03. Seleccionar opciones

OPCIONES	Código*
SwitchDIM Tunable White	926600
<ul style="list-style-type: none"> • Para L ≤ 1682 mm permite controlar un máximo de 10 luminarias, L ≥ 1964 mm permite controlar un máximo de 5 luminarias por cada SwitchDIM Tunable White. 	
Suspensión	
S5 L1500 mm (x1)	910408
S5 L1500 mm (x2)	910409
S5 L3000 mm (x1)	910419
S5 L3000 mm (x2)	910412
S5 L6000 mm (x1)	910420
S5 L6000 mm (x2)	910421
Cable de alimentación transparente	
L1500 mm - 3 x 0,75 mm ²	940400
L1500 mm - 5 x 0,75 mm ²	940500
L1500 mm - 7 x 0,75 mm ²	940600
L3000 mm - 3 x 0,75 mm ²	940401
L3000 mm - 5 x 0,75 mm ²	940501
L3000 mm - 7 x 0,75 mm ²	940601
L6000 mm - 3 x 0,75 mm ²	940402
L6000 mm - 5 x 0,75 mm ²	940507
L6000 mm - 7 x 0,75 mm ²	940602
<ul style="list-style-type: none"> • Para la opción DALI con kit de emergencia teledomable, es necesario solicitar 2 cables de alimentación de 5 x 0,75 mm². 	
Base cuadrada	
Superficie T25	45  100 978610♣
Superficie T29 (DALI+K3)	978611♣
Empotrar T7	 Ø70 35  90 971400♣
Empotrar T59 (DALI+K3)	971410♣
Base circular	
Superficie T24	45  Ø95 978600♣
Superficie T26 (DALI+K3)	978601♣
Empotrar T5	 Ø70 33  Ø90 971300♣
Empotrar T27 (DALI+K3)	978700♣
Versión low output	
<ul style="list-style-type: none"> • Mediante solicitud. 	



*Sustituya los símbolos para completar el código

Color ♣
 Blanco W
 Negro B



Detalles del producto



Perfil exterior



Perfil interno simétrico

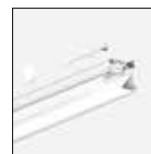

Perfil interior asimétrico



Tapas sin tornillos visibles



Uniformidad de la luz



Suspensión



Difusor clip-in

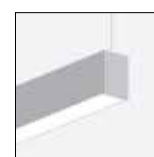

Aplicación suspendida



Difusor bGLARE



Difusor bLINE



Difusor ASYM



SwitchDIM Tunable White

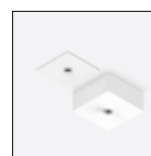

Base cuadrada



Base circular



REBA 65 D/I Line



Características del producto

Cuerpo

Perfil de aluminio extruido

Acabado

Pintado en epoxi-poliéster

Sistema óptico

bGLARE - Difusor microprismático

bLINE - Difusor opalino

ASYM - Difusor Asimétrico

Fuente de luz

LED, RG1, CRI>80, MacAdam Step ≤ 3

Vida útil del LED

80.000h @ L90, B10, Ta 25°C

Fuente de alimentación

Driver LED 220-240V-50/60Hz incluido



230V/50Hz

IP 40

ASYM
850°C

bGLARE
850°C

bLINE
960°C

01. Seleccionar perfil exterior



PERFIL EXTERIOR

Inicial / Final (SRT/END)

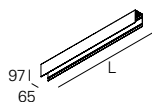

Lmm	CÓDIGO*
1127	90512L0040▲0083
1407	90512L0050▲0083
1687	90512L0060▲0083
2249	90512L0080▲0083
2529	90512L0090▲0083
2809	90512L0100▲0083

Intermedio (MID)

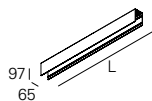

Lmm	CÓDIGO*
1122	90512L0040▲0000
1402	90512L0050▲0000
1682	90512L0060▲0000
2244	90512L0080▲0000
2524	90512L0090▲0000
2804	90512L0100▲0000

Ángulo horizontal (HRZ) - Ángulo horizontal (EDGE)

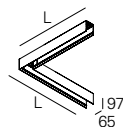

Lmm	CÓDIGO*
608	90512H0040▲0000

PERFIL EXTERIOR

- Difusor de la parte indirecta incluido en el producto.
- Para completar el producto, es necesario pedir el perfil interior por separado.
- Para completar una línea, es necesario un Start Kit, cableado de línea continua y kit de unión. Por favor solicítelo por separado.
- Para completar el producto es necesario añadir perfil interior, suspensión, cable de alimentación transparente y base de techo. Por favor solicítelo por separado.
- Las dimensiones no incluyen el star kit. Incremente 6 mm a la longitud para completar la línea.
- La longitud máxima de línea con un solo punto de alimentación es de 15000 mm.

*Sustituya los símbolos para completar el código

Color	▲
□ Blanco	W
■ Gris	G
■ Negro	B

02. Seleccionar perfil interior y difusor



PERFIL INTERIOR | SIMÉTRICO

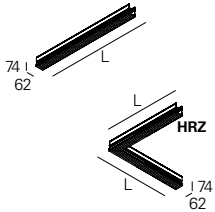

bGLARE - Difusor microprismático (60%/40%)

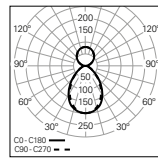

W	lm output	lm/W	Lmm	CÓDIGO*	
52	5250	101	1122	90532L004♥W0♦00	
65	6749	104	1402	90532L005♥W0♦00	
77	8249	107	1682	90532L006♥W♦♦00	
102	10499	103	2244	90532L008♥W0♦00	
117	11999	103	2524	90532L009♥W0♦00	
130	13499	104	2804	90532L010♥W0♦00	
HRZ	45	4500	100	604	90532H004♥W0♦00

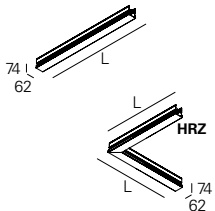

bLINE - Difusor opalino (60%/40%)

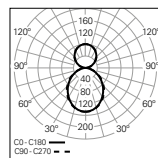

W	lm output	lm/W	Lmm	CÓDIGO*	
52	5340	103	1122	90531L004♥W0♦00	
65	6866	106	1402	90531L005♥W0♦00	
77	8392	109	1682	90531L006♥W♦♦00	
102	10680	105	2244	90531L008♥W0♦00	
117	12206	104	2524	90531L009♥W0♦00	
130	13732	106	2804	90531L010♥W0♦00	
HRZ	45	4577	102	604	90531H004♥W0♦00

*Sustituya los símbolos para completar el código

Fuente de alimentación	▼
HF	E
DALI	H
HF+CD ¹	Q
SWD+CD ²	Y

Emergencia	●
No EM	0
EM 3h (K3) ³	3

Temp. de color	♦
3000K	3
4000K	0
Tunable White ⁴	T

PERFIL INTERIOR | ASIMÉTRICO

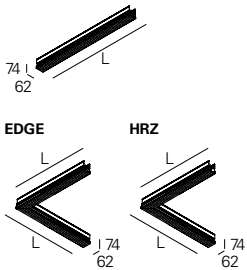

ASYM - Difusor (60%/40%)

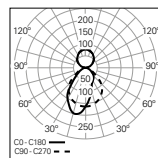

W	lm output	lm/W	Lmm	CÓDIGO*	
51	4888	96	1122	90534L004♥W0♦00	
66	6284	95	1402	90534L005♥W0♦00	
79	7680	97	1682	90534L006♥W♦♦00	
100	9775	98	2244	90534L008♥W0♦00	
117	11172	95	2524	90534L009♥W0♦00	
133	12568	94	2804	90534L010♥W0♦00	
EDGE	44	4189	95	604	90534E004♥W0♦00
HRZ	44	4189	95	604	90534H004♥W0♦00



¹ HF + Doble circuito.

² SwitchDIM + Doble circuito.

³ Preparado para telemando.

⁴ Sólo disponible en las versiones DALI y SWD+CD sin kit de emergencia (No EM).

03. Seleccionar opciones

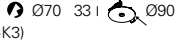
OPCIONES	Código*
SwitchDIM Tunable White	926600
<ul style="list-style-type: none"> • Para L ≤ 1682 mm permite controlar un máximo de 10 luminarias, L ≥ 1964 mm permite controlar un máximo de 5 luminarias por cada SwitchDIM Tunable White. 	
Start kit - Tapas inicio/final	923700▲
<ul style="list-style-type: none"> • Dos tapas finales incluidas. 	
Cableado de línea continua	
<ul style="list-style-type: none"> • Estándar 	
3 x 1,5 mm ²	945650
4 x 1,5 mm ²	948400
5 x 1,5 mm ²	945750
<ul style="list-style-type: none"> • 2 x 1,5 mm² 	
HF+K3 (x1) - L562 - L1682 mm	948000
HF+K3 (x2) - L1964 - L2804 mm	948001
<ul style="list-style-type: none"> • 2 x 1,5 mm² + Boma de conexión 5P 	
DALI+K3 (x1) - L562 - L1682 mm	948200
DALI+K3 (x2) - L1964 - L2804 mm	948201
<ul style="list-style-type: none"> • 2 x 1,5 mm² + 2 x 0,75 mm² + Boma de conexión 5P 	
K3+TEL (x1) - L562 - L1682 mm	948100
K3+TEL (x2) - L1964 - L2804 mm	948101
Kit de unión	932210
<ul style="list-style-type: none"> • Unión galvanizada, tornillos incluidos. 	
Suspensión	
S5 L1500 mm (x1)	910408
S5 L1500 mm (x2)	910409
S5 L3000 mm (x1)	910419
S5 L3000 mm (x2)	910412
S5 L6000 mm (x1)	910420
S5 L6000 mm (x2)	910421
Cable de alimentación transparente	
3 x 1,5 mm ²	94030▲
5 x 1,5 mm ²	94000▲
7 x 1,5 mm ²	94010▲
<ul style="list-style-type: none"> • Para la opción DALI con kit de emergencia telemandable, es necesario solicitar 2 cables de alimentación de 5 x 1,5 mm². 	
Base cuadrada ⁵	
Superficie T25	45  100 978610▲
Superficie T29 (DALI+K3)	978611▲
Empotrar T7	 90 971400▲
Empotrar T59 (DALI+K3)	971410▲
Base circular ⁵	
Superficie T24	45  95 978600▲
Superficie T26 (DALI+K3)	978601▲
Empotrar T5	 90 971300▲
Empotrar T27 (DALI+K3)	978700▲
Módulo ciego	
L1500 mm	993040▲
L3000 mm	993041▲
<ul style="list-style-type: none"> • Incluye perfil interior vacío y tapa ciega de aluminio. 	
Versión low output	
<ul style="list-style-type: none"> • Mediante solicitud. 	
Proyectos a medida	
<ul style="list-style-type: none"> • Mediante solicitud. 	



*Sustituya los símbolos para completar el código

Longitud	▲
L1500 mm	0
L3000 mm	1
L6000 mm	2

Color ⁵	▲
<input type="checkbox"/> Blanco	W
<input type="checkbox"/> Gris	G
<input checked="" type="checkbox"/> Negro	B



Detalles del producto



Perfil exterior



Perfil interno simétrico

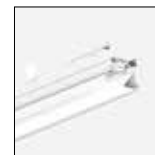

Perfil interior asimétrico



Tapas sin tornillos visibles



Unión sin salidas de luz



Uniformidad de la luz



Suspensión



Difusor clip-in

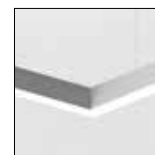

Ángulo horizontal



Aplicación suspendida



Difusor bGLARE



Difusor bLINE



Difusor ASYM



SwitchDIM Tunable White



Start kit

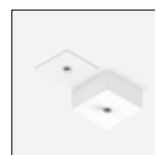

Base cuadrada



Base circular

⁵ Bases de techo solo están disponibles en blanco o negro.





ILUMINACIÓN TÉCNICA





CORA



CORA /E
620



CORA
624



CORA /C
628



Tipos de aplicación



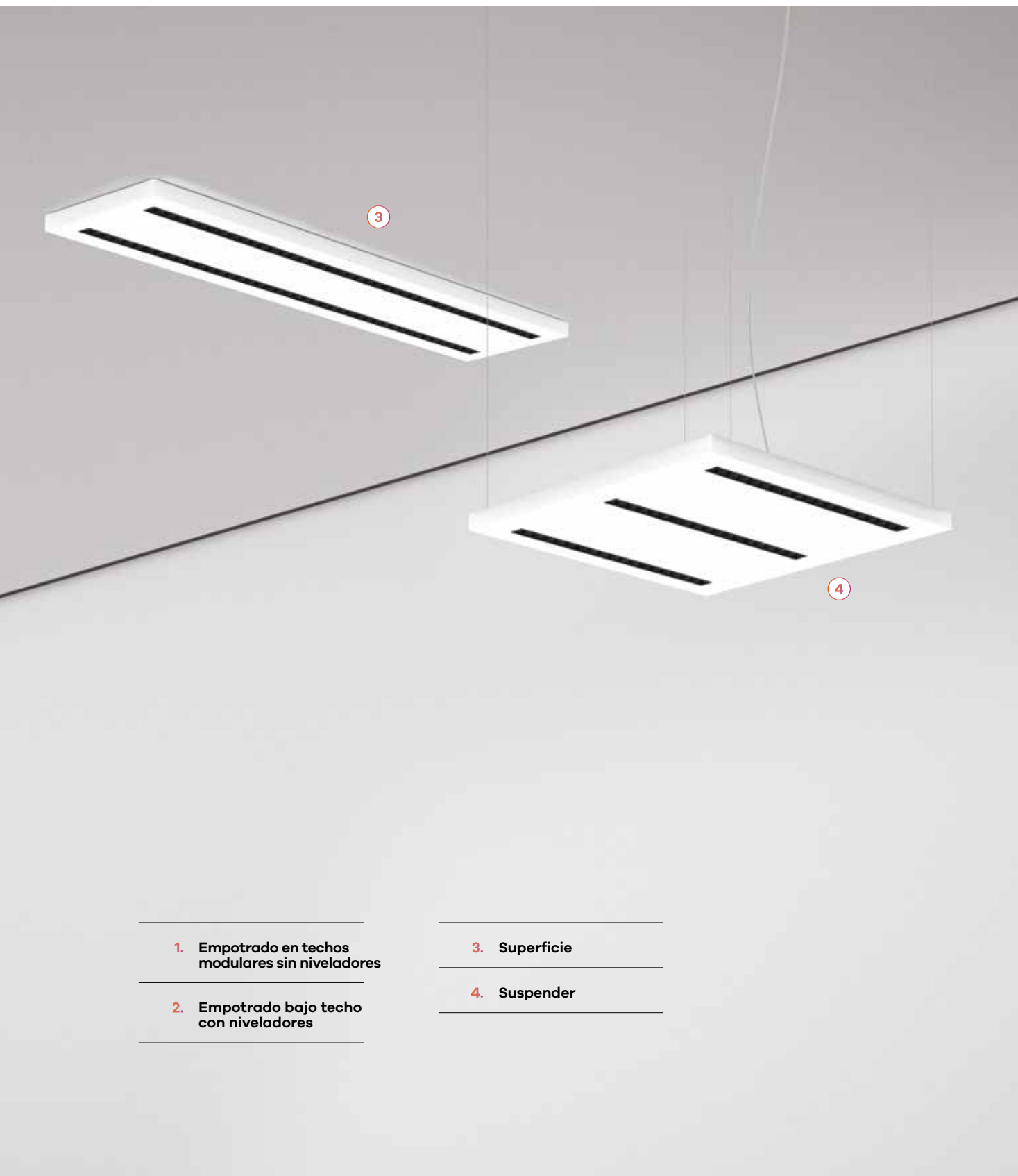

1. Empotrado en techos modulares sin niveladores

2. Empotrado bajo techo con niveladores

3. Superficie

4. Suspende

CORA /E



Características del producto

Cuerpo

Chapa de acero



Acabado

Pintado en epoxi-poliéster

230V/50Hz

Sistema óptico

bOPTICS - Reflector simétrico



Fuente de luz

LED, RG1, CRI>80, MacAdam Step ≤3



Vida útil del LED

80.000h @ L90, B10, Ta 25°C

Fuente de alimentación

Driver LED 220-240V-50/60Hz incluido

Espesor del techo

Versión de empotrar en techos modulares con perfil en T visible de 15/24 mm sin niveladores

Versión de empotrar en techo de 10, 13, 15 y 18 mm con niveladores

01. Seleccionar versión



CORA /E 2

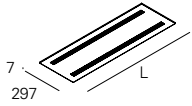

bOPTICS - Reflector simétrico 48°

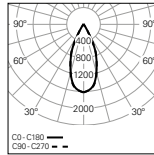

UGR	W	lm output	lm/W	Lmm	ƒ	CÓDIGO*
≤10	18	2272	126	597	572x272	90729L260▼▲◆♦00
≤10	30	3779	126	897	872x272	90729L290▼▲◆♦00
≤10	39	5286	136	1197	1172x272	90729L212▼▲◆♦00
≤10	50	6816	136	1497	1472x272	90729L215▼▲◆♦00

*Sustituya los símbolos para completar el código

Fuente de alimentación ▼

HF	E
DALI	H

Color ▲

□ Blanco	W
■ Negro	B

Emergencia ●

No EM	0
EM 3h (K3) ¹	3

Temp. de color ◆

3000K	3
4000K	0

CORA /E 3

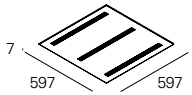

bOPTICS - Reflector simétrico 48°

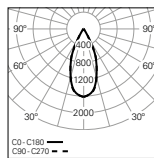

UGR	W	lm output	lm/W	ƒ	CÓDIGO*
≤10	26	3408	131	572x572	90729Q360▼▲◆♦00

CORA /E 4

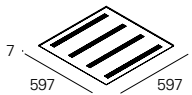

bOPTICS - Reflector simétrico 48°

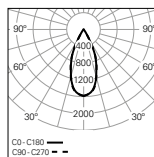

UGR	W	lm output	lm/W	ƒ	CÓDIGO*
≤10	34	4544	134	572x572	90729Q460▼▲◆♦00

CORA 2 | CORA 3 | CORA 4

- Para la versión de empotrar bajo techo de cartón yeso, debe pedirse por separado un kit de empotrar (x4).

¹ Preparado para telemando.

02. Seleccionar opciones

OPCIONES	Código
Kit de empotramiento (x4)	927700
Cable de seguridad en acero L1500 mm	955000
Versión de baja potencia	
• Mediante solicitud.	
Proyectos a medida	
• Mediante solicitud.	



Detalles del producto



Aplicación en techos
modulares de perfil en T visto techo con niveladores



Aplicación empotrada bajo
techo con niveladores



Difusor bOPTICS

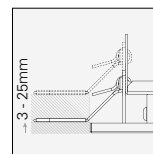

Aplicación empotrada
bajo techo con
niveladores



Aplicación empotrada
bajo techo con
niveladores

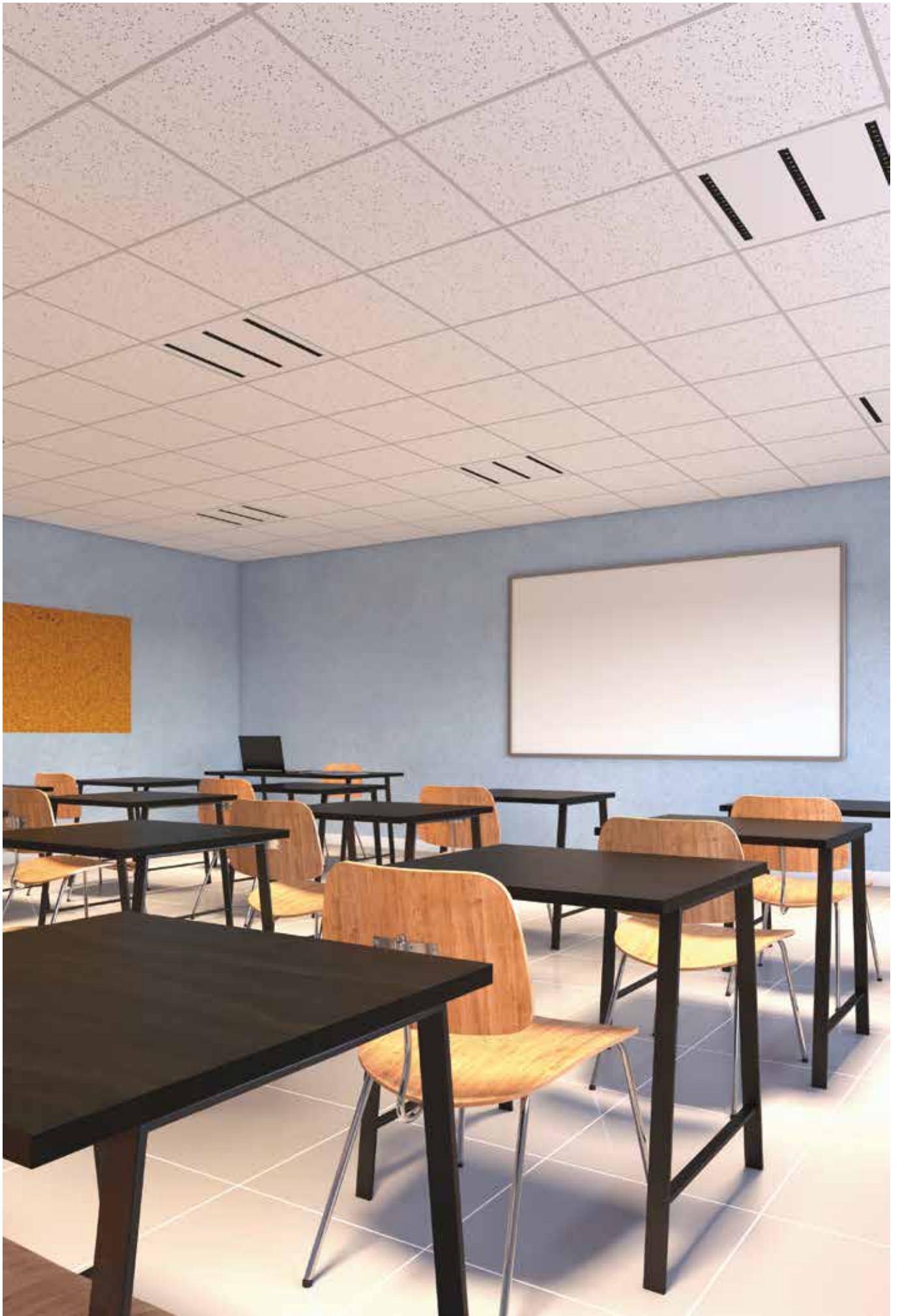

CORA



Características del producto

Cuerpo

Chapa de acero



Acabado

Pintado en epoxi-poliéster

230V/50Hz

Sistema óptico

bOPTICS - Reflector simétrico

Fuente de luz

LED, RG1, CRI>80, MacAdam Step ≤ 3



IP 20

Vida útil del LED

80.000h @ L90, B10, Ta 25°C

650°C

Fuente de alimentación

Driver LED 220-240V-50/60Hz incluido

01. Seleccionar versión



CORA 2

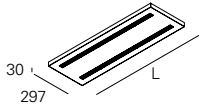

bOPTICS - Reflector simétrico 48°

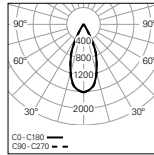

UGR	W	lm output	lm/W	Lmm	CÓDIGO*
≤10	18	2272	126	597	90727L260♥♣♦♦00
≤10	30	3779	126	897	90727L290♥♣♦♦00
≤10	39	5286	136	1197	90727L212♥♣♦♦00
≤10	50	6816	136	1497	90727L215♥♣♦♦00

*Sustituya los símbolos para completar el código

Fuente de alimentación ▼

HF	E
DALI	H

Color ♠

□ Blanco	W
■ Negro	B

Emergencia ●

No EM	0
EM 3h (K3) ¹	3

Temp. de color ♦

3000K	3
4000K	0

CORA 3

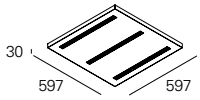

bOPTICS - Reflector simétrico 48°

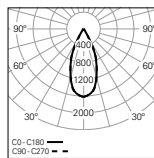

UGR	W	lm output	lm/W	CÓDIGO*
≤10	26	3408	131	90727Q360♥♣♦♦00

CORA 4

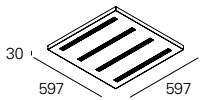

bOPTICS - Reflector simétrico 48°

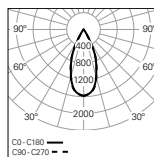





UGR	W	lm output	lm/W	CÓDIGO*
≤10	34	4544	134	90727Q460♥♣♦♦00

CORA 2 | CORA 3 | CORA 4

• Para completar el producto es necesario pedir la suspensión, el cable y la base de alimentación por separado.

¹ Preparado para teledmando.

02. Seleccionar opciones

OPCIONES	Código*
Suspensión	
S11 L1500 mm (x4)	9129041
S11 L3000 mm (x4)	9129042
S11 L6000 mm (x4)	9129043
Cable de alimentación transparente	
L1500 mm - 3 x 0,75 mm ²	940400
L1500 mm - 5 x 0,75 mm ²	940500
L1500 mm - 7 x 0,75 mm ²	940600
L3000 mm - 3 x 0,75 mm ²	940401
L3000 mm - 5 x 0,75 mm ²	940501
L3000 mm - 7 x 0,75 mm ²	940601
L6000 mm - 3 x 0,75 mm ²	940402
L6000 mm - 5 x 0,75 mm ²	940507
L6000 mm - 7 x 0,75 mm ²	940602
<ul style="list-style-type: none"> • Para la opción DALI con kit de emergencia teledomable, es necesario solicitar 2 cables de alimentación de 5 x 0,75 mm². 	
Base de alimentación	
Superficie T25  45 l  100	978610♣
Superficie T29 (DALI+K3)	978611♣
Empotrar T7  Ø70 35 l  90	971400♣
Empotrar T59 (DALI+K3)	971410♣
Versión de baja potencia	
<ul style="list-style-type: none"> • Mediante solicitud. 	



*Sustituya los símbolos para completar el código

Color 

Blanco W

Negro B



Detalles del producto



Aplicación suspendida



Difusor bOPTICS

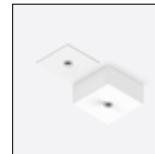

Bases de alimentación

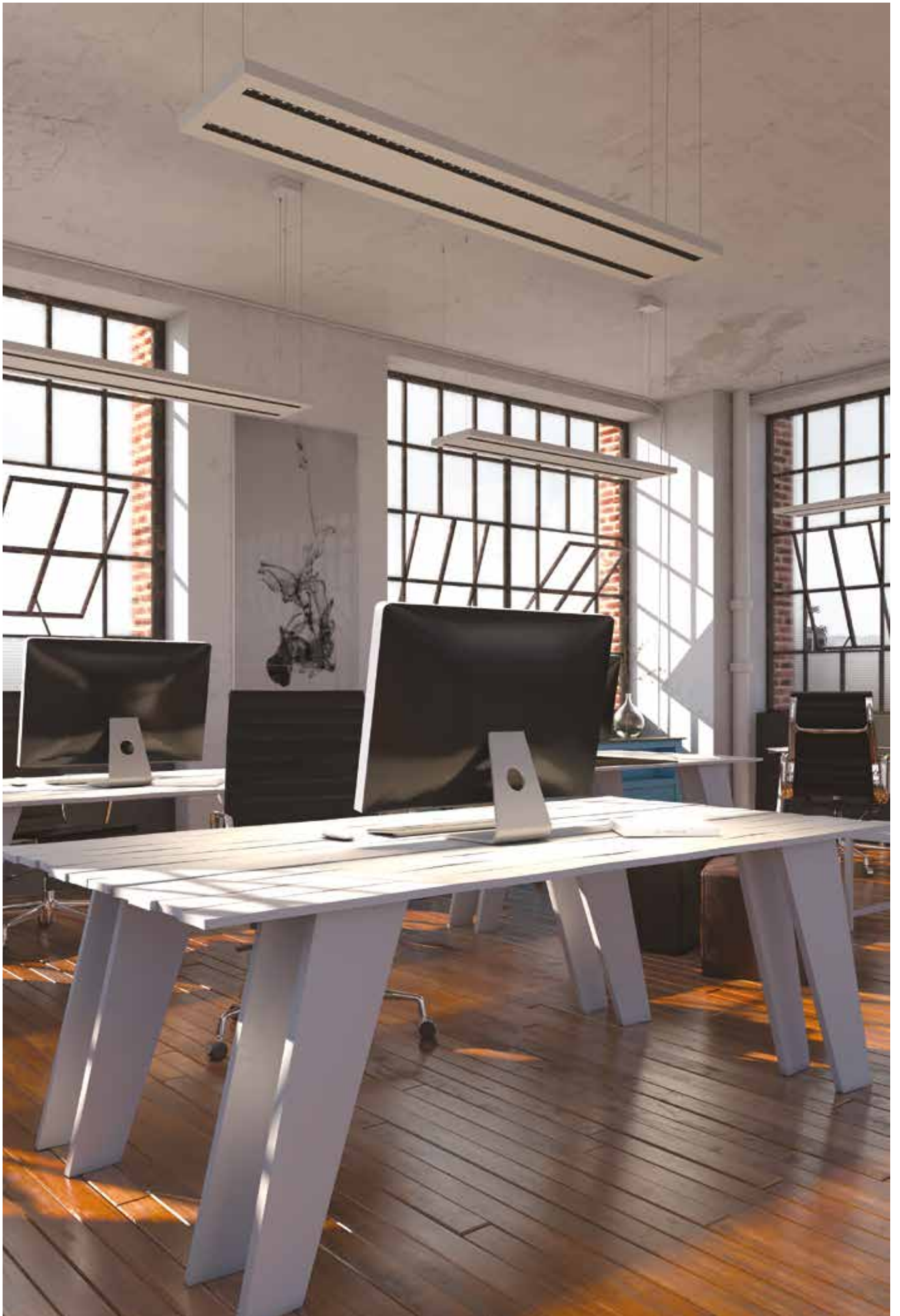

CORA /C



Características del producto

Cuerpo

Chapa de acero



Acabado

Pintado en epoxi-poliéster

230V/50Hz

Sistema óptico

bOPTICS - Reflector simétrico

Fuente de luz

LED, RG1, CRI>80, MacAdam Step ≤ 3



Vida útil del LED

80.000h @ L90, B10, Ta 25°C

650°C

Fuente de alimentación

Driver LED 220-240V-50/60Hz incluido

01. Seleccionar versión



CORA / C 2

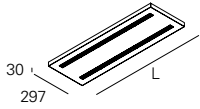

bOPTICS - Reflector simétrico 48°

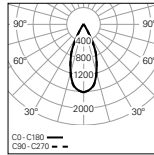

UGR	W	lm output	lm/W	Lmm	CÓDIGO*
≤10	18	2272	126	597	90728L260▼▲◆♦00
≤10	30	3779	126	897	90728L290▼▲◆♦00
≤10	39	5286	136	1197	90728L212▼▲◆♦00
≤10	50	6816	136	1497	90728L215▼▲◆♦00

*Sustituya los símbolos para completar el código

Fuente de alimentación	
HF	E
DALI	H

Color	
□ Blanco	W
■ Negro	B

Emergencia	
No EM	0
EM 3h (K3) ¹	3

CORA / C 3

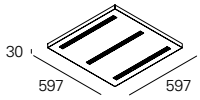

bOPTICS - Reflector simétrico 48°

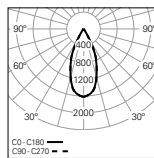

UGR	W	lm output	lm/W	CÓDIGO*
≤10	26	3408	131	90728Q360▼▲◆♦00

Temp. de color	
3000K	3
4000K	0

CORA / C 4

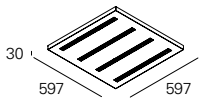

bOPTICS - Reflector simétrico 48°

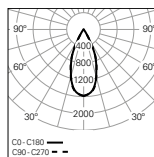

UGR	W	lm output	lm/W	CÓDIGO*
≤10	34	4544	134	90728Q460▼▲◆♦00

¹ Preparado para telemando.

02. Seleccionar opciones

OPCIONES	Código
----------	--------

Versión de baja potencia

- Mediante solicitud.



Detalles del producto



Aplicación de superficie



Difusor bOPTICS

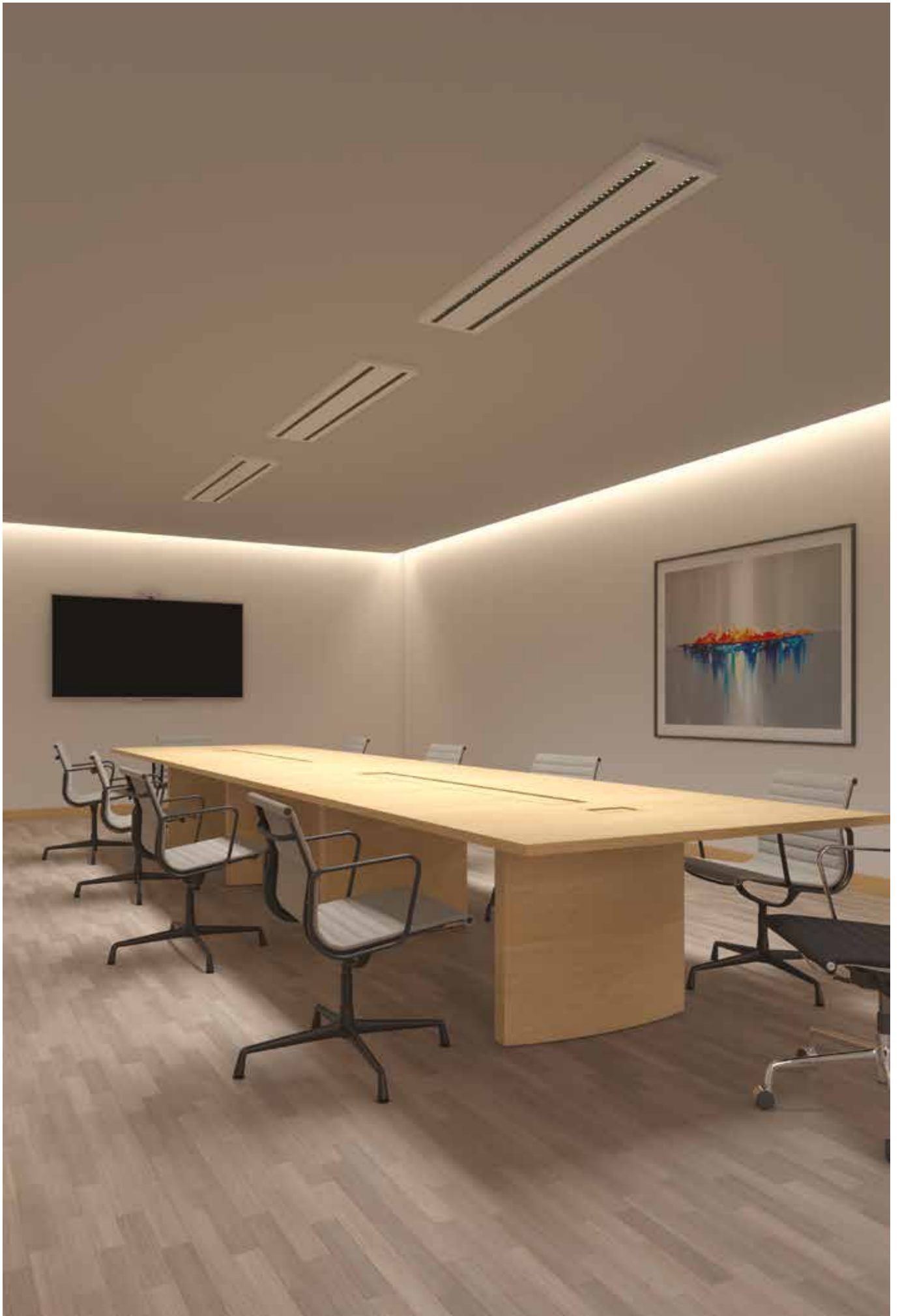



Iluminación
técnica

CLOUD



CLOUD
634



CLOUD

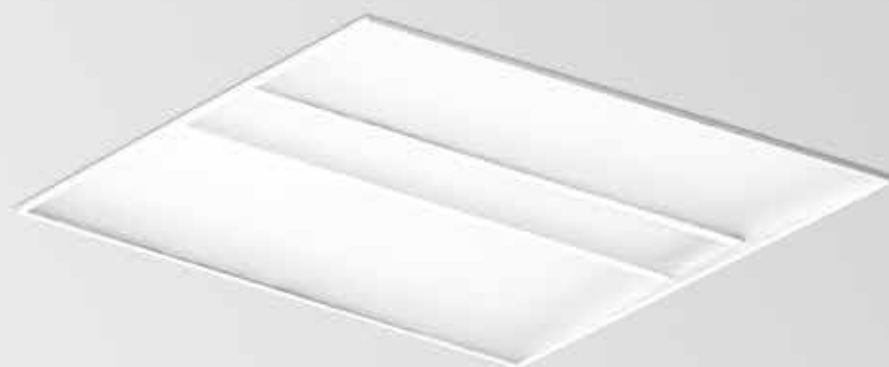

Características del producto

Cuerpo

Chapa de acero



Acabado

Pintado en epoxi-poliéster blanco mate

230V/50Hz

Sistema de fijación

Versión de empotrar en techo con niveladores



Sistema óptico

DAM - Difusor microprismático

Fuente de luz

LED, RG1, CRI>80, MacAdam Step ≤ 3



Vida útil del LED

80.000h @ L90, B10, Ta 25°C

Fuente de alimentación

Driver LED 220-240V-50/60Hz incluido

Espesor del techo

Para techos entre 1-25 mm

01. Seleccionar versión



CLOUD

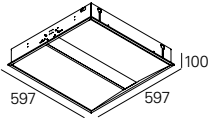

DAM - Difusor microprismático

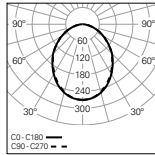

UGR	W	lm output	lm/W	□	CÓDIGO*
≤19	41	4370	107	582x582	90840L060▼W●◆♣
≤22	47	5376	114	582x582	90839L060▼W●◆♣

*Sustituya los símbolos para completar el código

Fuente de alimentación	▼
HF	E
DALI	H

Emergencia	●
No EM	0
EM 3h (K3) ¹	3

Temp. de color	◆
3000K	3
4000K	0

Conector	♣
Sin conector	00
W3M ²	W3
W5MD ³	W5

02. Seleccionar opciones



Detalles del producto

OPCIONES	Código
Cable de seguridad en acero L1500 mm	955000
Ventilación de retorno de aire • Mediante solicitud.	
Proyectos a medida • Mediante solicitud.	

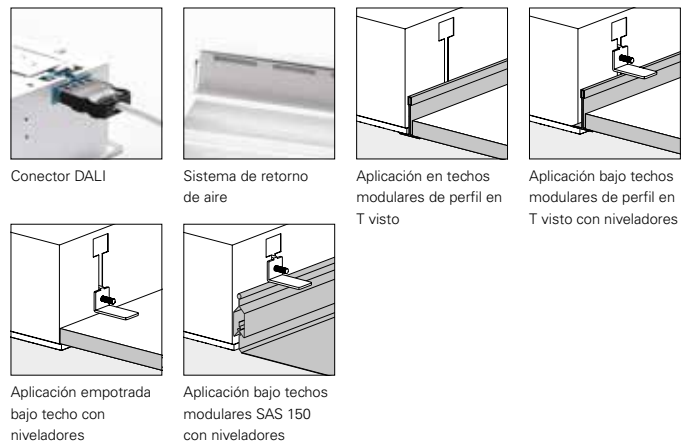

¹ Preparado para telemando.

² Conector Wieland 3 polos GST18i3 macho.

³ Conector Wieland 5 polos GST18i5 DIM macho.



Iluminación
técnica

TEI



TEI
638





Características del producto

Cuerpo

Chapa de acero



Acabado

Pintado en epoxi-poliéster blanco mate

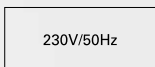

Sistema de fijación

Versión de empotrar en techo con niveladores



Sistema óptico

DCS - Difusor microperforado

Fuente de luz

LED, RG1, CRI>80, MacAdam Step ≤ 3



Vida útil del LED

80.000h @ L90, B10, Ta 25°C

Fuente de alimentación

Driver LED 220-240V-50/60Hz incluido

Espesor del techo

Para techos entre 1-25 mm

01. Seleccionar versión

TEI

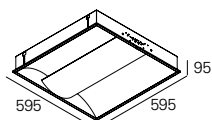

DCS - Difusor microperforado

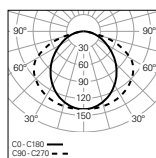

UGR	W	lm output	lm/W	■	CÓDIGO*
≤19	29	2223	77	578x578	90853L060▼W●◆♣
≤22	43	3334	78	578x578	90852L060▼W●◆♣



*Sustituya los símbolos para completar el código

Fuente de alimentación	▼
HF	E
DALI	H

Emergencia	●
No EM	0
EM 3h (K3) ¹	3

Temp. de color	◆
3000K	3
4000K	0

Conector	♣
Sin conector	00
W3M ²	W3
W5MD ³	W5

02. Seleccionar opciones

OPCIONES	Código
----------	--------

Cable de seguridad en acero L1500 mm	955000
--	--------

Proyectos a medida

- Mediante solicitud.

¹ Preparado para telemando.

² Conector Wieland 3 polos GST18i3 macho.

³ Conector Wieland 5 polos GST18i5 DIM macho.



Iluminación
técnica

bLED



bLED
642



bLED

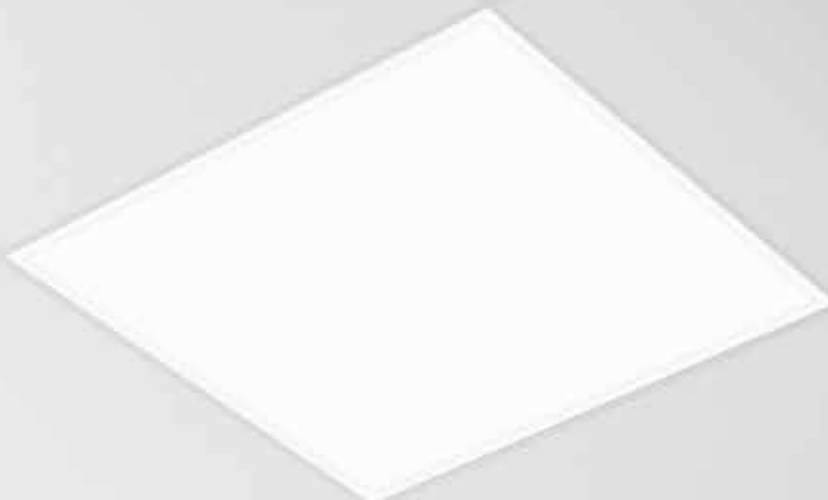

Características del producto

Cuerpo

Chapa de acero



Acabado

Pintado en epoxi-poliéster blanco mate

230V/50Hz

Sistema de fijación

Versión de empotrar en techos modulares
con perfil en T visible de 15/24 mm sin
niveladores



Sistema óptico

DAM - Difusor microprismático
LIGHT+ - Difusor opalino



Fuente de luz

LED, RG1, CRI>80, MacAdam Step ≤3

Vida útil del LED

80.000h @ L90, B10, Ta 25°C

Fuente de alimentación

Driver LED 220-240V-50/60Hz incluido

01. Seleccionar versión

bLED

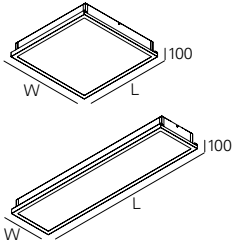

DAM - Difusor microprismático

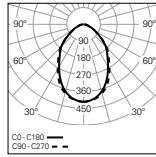

UGR	W	lm output	lm/W	LxWmm	CÓDIGO*
≤19	44	5683	129	595x595	90843L060▼W◆◆00
≤19	44	5683	129	1195x295	90843L120▼W◆◆00

LIGHT+ - Difusor opalino

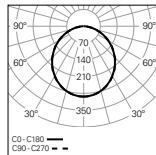

UGR	W	lm output	lm/W	LxWmm	CÓDIGO*
≤22	44	6144	140	595x595	90841L060▼W◆◆00
≤22	44	6144	140	1195x295	90841L120▼W◆◆00



*Sustituya los símbolos para completar el código

Fuente de alimentación	▼
HF	E
DALI	H

Emergencia	●
No EM	0
EM 3h (K3) ¹	3

Temp. de color	◆
3000K	3
4000K	0

02. Seleccionar opciones

OPCIONES Código

Cable de seguridad en acero
L1500 mm 955000

Versión IP20/65
• Mediante solicitud.

CRI>90
• Mediante solicitud.

Versión de baja potencia
• Mediante solicitud.

Proyectos a medida
• Mediante solicitud.



Detalles del producto

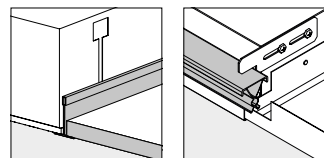

Aplicación en techos modulares de perfil en T visto

Aplicación en techos modulares SAS 120 (Mediante solicitud)

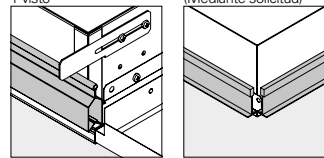

Aplicación en techos modulares SAS 150/330 (Mediante solicitud)

Aplicación bajo techos modulares Microlook 8 (Mediante solicitud)

¹ Preparado para telemando.



**Iluminación
técnica**

LNE



LNE
646



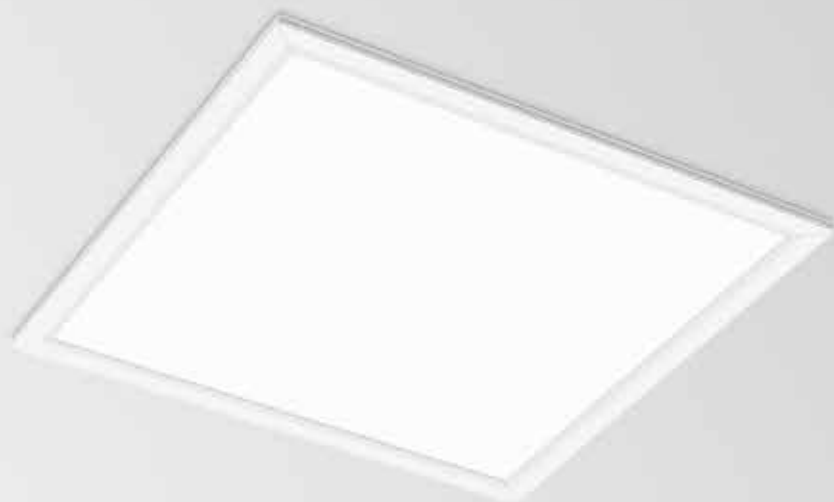

Características del producto

Cuerpo

Chapa de acero



Aro

Aluminio

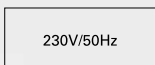

Acabado

Pintado en epoxi-poliéster blanco mate



Sistema de fijación

Versión de empotrar en techo con niveladores

Sistema óptico

DAM - Difusor microprismático
LIGHT+ - Difusor opalino



Fuente de luz

LED, RG1, CRI>80, MacAdam Step ≤ 3

Vida útil del LED

80.000h @ L80, B10, Ta 25°C

Fuente de alimentación

Driver LED 220-240V-50/60Hz incluido

Espesor del techo

Para techos entre 1-25 mm

01. Seleccionar versión

LNE

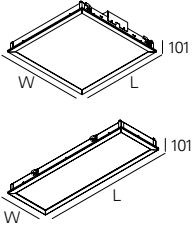

DAM - Difusor microprismático

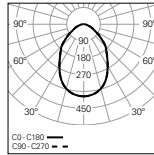

UGR	W	lm output	lm/W	LxWmm	□	CÓDIGO*
≤19	26	3169	122	897x297	882x282	90827L093♥W●●♣
≤19	34	4225	124	1197x297	1182x282	90827L123♥W●●♣
≤19	42	5282	126	1497x297	1482x282	90827L153♥W●●♣
≤19	34	4225	124	597x597	582x582	90827L066♥W●●♣

LIGHT+ - Difusor opalino

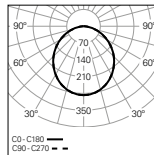

UGR	W	lm output	lm/W	LxWmm	□	CÓDIGO*
≤22	26	3441	132	897x297	882x282	90828L093♥W●●♣
≤22	34	4587	135	1197x297	1182x282	90828L123♥W●●♣
≤22	42	5734	137	1497x297	1482x282	90828L153♥W●●♣
≤22	34	4587	135	597x597	582x582	90828L066♥W●●♣



*Sustituya los símbolos para completar el código

Fuente de alimentación	▼
HF	E
DALI	H

Emergencia	●
No EM	0
EM 3h (K3) ¹	3

Temp. de color	◆
3000K	3
4000K	0

Conector	♣
Sin conector	00
W3M ²	W3
W5MD ³	W5

02. Seleccionar opciones

OPCIONES Código

CRI>90

- Mediante solicitud.

Cable de seguridad en acero

L1500 mm 955000



Detalles del producto



Marco con sistema click

¹ Preparado para telemando.

² Conector Wieland 3 polos GST18i3 macho.

³ Conector Wieland 5 polos GST18i5 DIM macho.



Iluminación
técnica

LNS



LNS
650



LNS



Características del producto

Cuerpo

Chapa de acero

Acabado

Pintado en epoxi-poliéster blanco mate

Sistema óptico

DAM - Difusor microprismático
LIGHT+ - Difusor opalino

Fuente de luz

LED, RG1, CRI>80, MacAdam Step ≤ 3

Vida útil del LED

80.000h @ L80, B10, Ta 25°C

Fuente de alimentación

Driver LED 220-240V-50/60Hz incluido



230V/50Hz



IP 40

650°C

01. Seleccionar versión

LNS

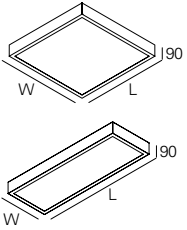

DAM - Difusor microprismático

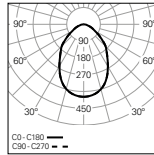

UGR	W	lm output	lm/W	LxWmm	CÓDIGO*
≤19	26	3169	122	873x320	90829L063▼W◆◆00
≤19	34	4225	124	1149x320	90829L123▼W◆◆00
≤19	42	5282	126	1425x320	90829L153▼W◆◆00
≤19	34	4225	124	597x597	90829L066▼W◆◆00

LIGHT+ - Difusor opalino

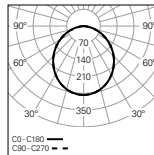

UGR	W	lm output	lm/W	LxWmm	CÓDIGO*
≤22	26	3441	132	873x320	90830L063▼W◆◆00
≤22	34	4587	135	1149x320	90830L123▼W◆◆00
≤22	42	5734	137	1425x320	90830L153▼W◆◆00
≤22	34	4587	135	597x597	90830L066▼W◆◆00



*Sustituya los símbolos para completar el código

Fuente de alimentación	▼
HF	E
DALI	H

Emergencia	●
No EM	0
EM 3h (K3) ¹	3

Temp. de color	◆
3000K	3
4000K	0

02. Seleccionar opciones

OPCIONES

CRI>90

- Mediante solicitud.



Detalles del producto



Marco con sistema click

¹ Preparado para telemando.

AMBIENTES ASÉPTICOS





**Ambientes
asépticos**

HOSPITAL AND CLEAN ROOMS



AVT
656



THE
658



THS
660



LNE IP
662



LNS IP
664



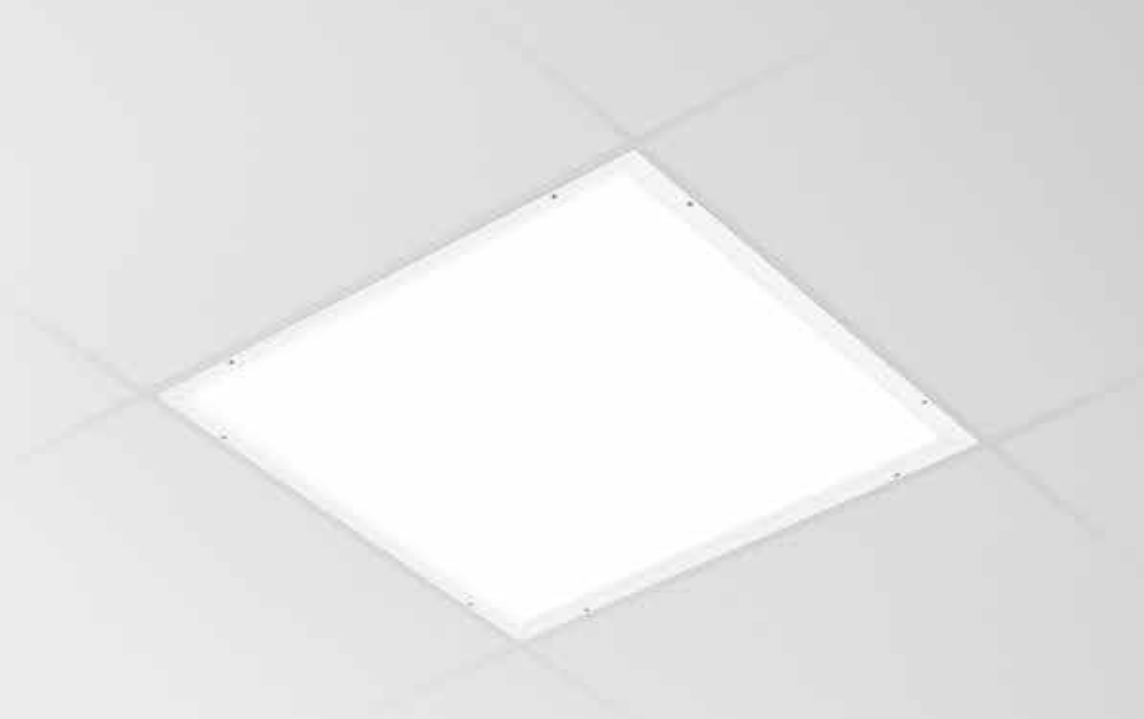

Características del producto

Cuerpo

Chapa de acero



Aro

Aluminium

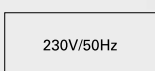

Acabado

Pintado en epoxi-poliéster blanco mate



Sistema de fijación

Versión de empotrar en techos modulares de perfil T visible sin niveladores



Cableado

Precableado con cable H05VV-F de 1000 mm

Sistema óptico

DAM - Difusor microprismático
LIGHT+ - Difusor opalino

Fuente de luz

LED, RG1, CRI>80, MacAdam Step ≤3

Vida útil del LED

80.000h @ L80, B10, Ta 25°C

Fuente de alimentación

Driver LED 220-240V-50/60Hz incluido



*Sustituya los símbolos para completar el código

Fuente de alimentación	
HF	E
DALI	H

Emergencia	
No EM	0
EM 3h (K3) ¹	3

01. Seleccionar versión

AVT

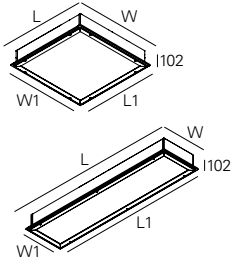

DAM - Difusor microprismático

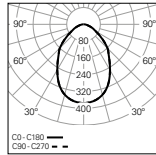

UGR	W	lm output	lm/W	LxWmm	L1xW1mm	CÓDIGO*
≤19	34	4104	121	1197x297	1175x275	90797L123♥VV●000
≤19	42	5131	122	1497x297	1475x275	90797L153♥VV●000
≤22	74	8656	117	1497x297	1475x275	90799L153♥VV●000
≤19	34	4104	121	597x597	575x575	90797L066♥VV●000
≤19	59	6925	117	597x597	575x575	90799L066♥VV●000

LIGHT+ - Difusor opalino

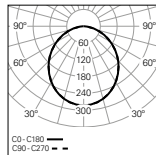

UGR	W	lm output	lm/W	LxWmm	L1xW1mm	CÓDIGO*
≤22	34	4527	133	1197x297	1175x275	90798L123♥VV●000
≤22	42	5659	135	1497x297	1475x275	90798L153♥VV●000
≤25	74	9548	129	1497x297	1475x275	90800L153♥VV●000
≤22	34	4527	133	597x597	575x575	90798L066♥VV●000
≤22	59	7638	129	597x597	575x575	90800L066♥VV●000

02. Seleccionar opciones

OPCIONES Código

Conector

Conector Wieland 3 polos GST18i3 macho	965301
Conector Wieland 5 polos GST18i5 DIM macho	965403

Cable de seguridad en acero

L1500 mm	955000
----------	--------

CRI>90

- Mediante solicitud.

Proyectos a medida

- Mediante solicitud.



Detalles del producto



Aplicación en techos modulares sin niveladores

¹ Preparado para telemando.

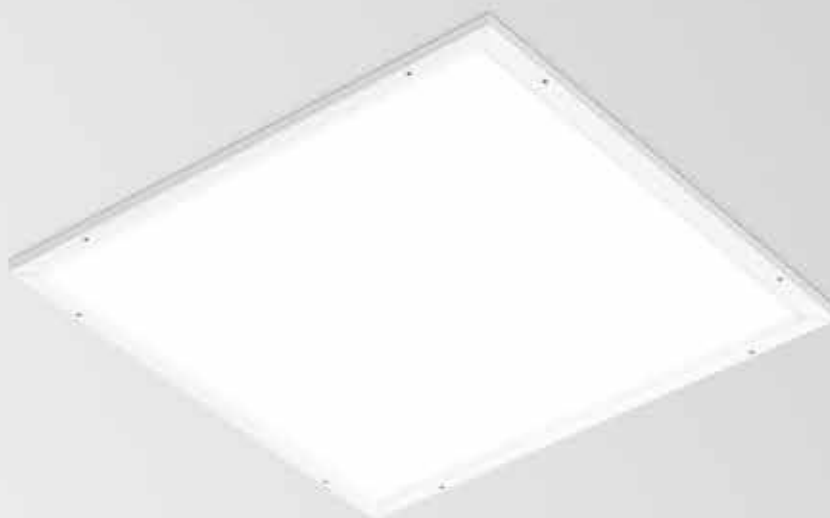

Características del producto

Cuerpo

Chapa de acero

Aro

Aluminium

Acabado

Pintado en epoxi-poliéster blanco mate

Sistema de fijación

Versión de empotrar en techo con niveladores

Cableado

Precableado con cable H05VV-F
de 1000 mm

Sistema óptico

DAM - Difusor microprismático
LIGHT+ - Difusor opalino

Fuente de luz

LED, RG1, CRI>80, MacAdam Step ≤ 3

Vida útil del LED

80.000h @ L80, B10, Ta 25°C

Fuente de alimentación

Driver LED 220-240V-50/60Hz incluido

Espesor del techo

Para techos entre 2-60 mm

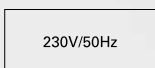

01. Seleccionar versión

THE

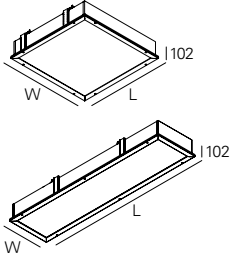

DAM - Difusor microprismático

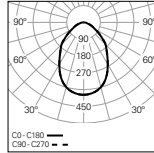

UGR	W	lm output	lm/W	LxWmm	ƒ	CÓDIGO*
≤19	34	4225	124	1197x297	1180x288	90793L123▼W●000
≤19	42	5282	126	1497x297	1480x288	90793L153▼W●000
≤19	74	8911	120	1497x297	1480x288	90795L153▼W●000
≤19	34	4225	124	597x597	580x588	90793L066▼W●000
≤19	59	7129	121	597x597	580x588	90795L066▼W●000

LIGHT+ - Difusor opalino

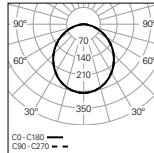

UGR	W	lm output	lm/W	LxWmm	ƒ	CÓDIGO*
≤22	34	4587	135	1197x297	1180x288	90794L123▼W●000
≤22	42	5734	137	1497x297	1480x288	90794L153▼W●000
≤25	74	9675	131	1497x297	1480x288	90796L153▼W●000
≤22	34	4587	135	597x597	580x588	90794L066▼W●000
≤22	59	7740	131	597x597	580x588	90796L066▼W●000



*Sustituya los símbolos para completar el código

Fuente de alimentación ▼
 HF E
 DALI H

Emergencia ●
 No EM 0
 EM 3h (K3) ¹ 3

02. Seleccionar opciones

OPCIONES	Código
Conector	
Conector Wieland 3 polos GST18i3 macho	965301
Conector Wieland 5 polos GST18i5 DIM macho	965403
Cable de seguridad en acero	
L1500 mm	955000
CRI>90	
• Mediante solicitud.	
Proyectos a medida	
• Mediante solicitud.	



Detalles del producto



Aplicación en techos modulares sin niveladores



Niveladores

¹ Preparado para telemando.

AMBIENTES
ASÉPTICOS

THS



Características del producto

Cuerpo

Chapa de acero

Aro

Aluminium

Acabado

Pintado en epoxi-poliéster blanco mate

Sistema óptico

DAM - Difusor microprismático
LIGHT+ - Difusor opalino

Fuente de luz

LED, RG1, CRI>80, MacAdam Step ≤ 3

Vida útil del LED

80.000h @ L80, B10, Ta 25°C

Fuente de alimentación

Driver LED 220-240V-50/60Hz incluido



230V/50Hz



IP 65

650°C

01. Seleccionar versión



THS

*Sustituya los símbolos para completar el código

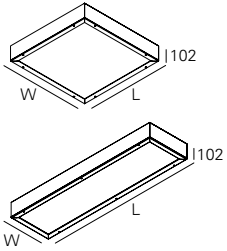

DAM - Difusor microprismático

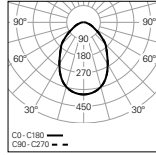

UGR	W	lm output	lm/W	LxWmm	CÓDIGO*
≤19	34	4225	124	1142x297	90801L123▼W●000
≤19	42	5282	126	1417x297	90801L153▼W●000
≤22	74	8911	120	1417x297	90803L153▼W●000
≤19	34	4225	124	597x597	90801L066▼W●000
≤19	59	7129	121	597x597	90803L066▼W●000

Fuente de alimentación	▼
HF	E
DALI	H

LIGHT+ - Difusor opalino

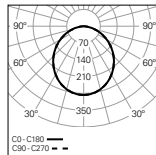

UGR	W	lm output	lm/W	LxWmm	CÓDIGO*
≤22	34	4587	135	1142x297	90802L123▼W●000
≤22	42	5734	137	1417x297	90802L153▼W●000
≤25	74	9675	120	1417x297	90804L153▼W●000
≤22	34	4587	135	597x597	90802L066▼W●000
≤22	59	7740	121	597x597	90804L066▼W●000

Emergencia	●
No EM	0
EM 3h (K3) ¹	3

02. Seleccionar opciones

OPCIONES

CRI>90

- Mediante solicitud.

¹ Preparado para telemando.

LNE IP

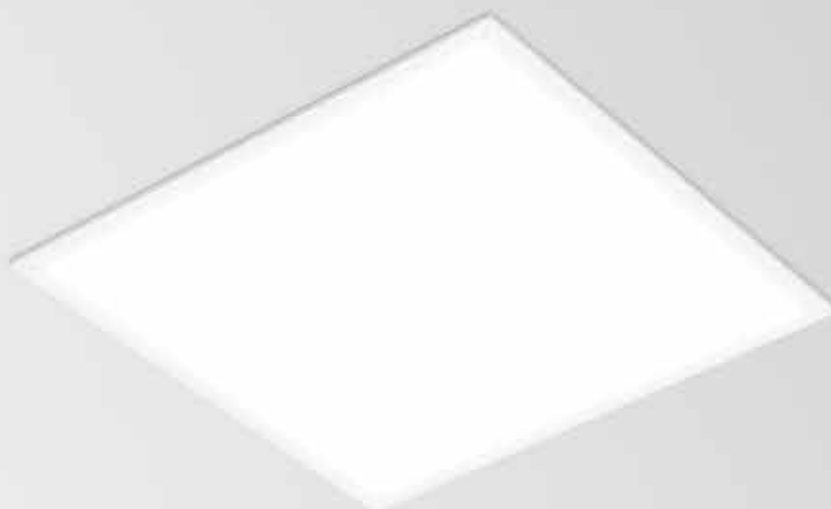

Características del producto

Cuerpo

Chapa de acero



Aro

Chapa de acero

230V/50Hz

Acabado

Pintado en epoxi-poliéster blanco mate



Sistema de fijación

Versión de empotrar en techo con niveladores

Sistema óptico

DAM - Difusor microprismático
LIGHT+ - Difusor opalino



Fuente de luz

LED, RG1, CRI>80, MacAdam Step ≤ 3

Vida útil del LED

80.000h @ L80, B10, Ta 25°C

Fuente de alimentación

Driver LED 220-240V-50/60Hz incluido

Espesor del techo

Para techos entre 1-25 mm

01. Seleccionar versión

LNE IP

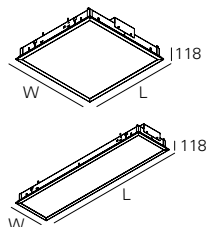

DAM - Difusor microprismático

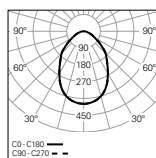

UGR	W	lm output	lm/W	LxWmm	ƒ	CÓDIGO*
≤19	34	4225	124	1197x297	1180x280	90805L123▼W●000
≤19	42	5282	126	1479x297	1480x280	90805L153▼W●000
≤19	34	4225	124	597x597	580x588	90805L066▼W●000

LIGHT+ - Difusor opalino

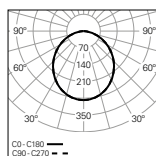

UGR	W	lm output	lm/W	LxWmm	ƒ	CÓDIGO*
≤22	34	4587	135	1197x297	1180x280	90806L123▼W●000
≤22	42	5734	137	1479x297	1480x280	90806L153▼W●000
≤22	34	4587	135	597x597	580x588	90806L066▼W●000



*Sustituya los símbolos para completar el código

Fuente de alimentación ▼
 HF E
 DALI H

Emergencia ●
 No EM 0
 EM 3h (K3) ¹ 3

02. Seleccionar opções

OPCIONES	Código
Conector	
Conector Wieland 3 polos GST18i3 macho	965301
Conector Wieland 5 polos GST18i5 DIM macho	965403
Cable de seguridad en acero	
L1500 mm	955000



Detalles del producto



Aplicación en techos modulares sin niveladores

¹ Preparado para telemando.

AMBIENTES
ASÉPTICOS

LNS IP



Características del producto

Cuerpo

Chapa de acero

Aro

Chapa de acero

Acabado

Pintado en epoxi-poliéster blanco mate

Sistema óptico

DAM - Difusor microprismático
LIGHT+ - Difusor opalino

Fuente de luz

LED, RG1, CRI>80, MacAdam Step ≤ 3

Vida útil del LED

80.000h @ L80, B10, Ta 25°C

Fuente de alimentación

Driver LED 220-240V-50/60Hz incluido



230V/50Hz



IP 54

650°C

01. Seleccionar versión

LNS IP

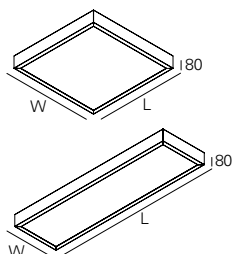

DAM - Difusor microprismático

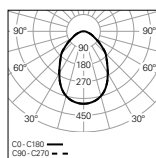

UGR	W	lm output	lm/W	LxWmm	CÓDIGO*
≤19	34	4225	124	1149x320	90809L123▼W●000
≤19	42	5282	126	1425x320	90809L153▼W●000
≤19	34	4225	124	597x597	90809L066▼W●000

LIGHT+ - Difusor opalino

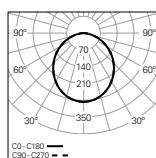

UGR	W	lm output	lm/W	LxWmm	CÓDIGO*
≤22	34	4587	135	1149x320	90810L123▼W●000
≤22	42	5734	137	1425x320	90810L153▼W●000
≤22	34	4587	135	597x597	90810L066▼W●000



*Sustituya los símbolos para completar el código

Fuente de alimentación ▼
 HF E
 DALI H

Emergencia ●
 No EM 0
 EM 3h (K3) ¹ 3

02. Seleccionar opciones

OPCIONES Código

Conector

Conector Wieland 3 polos GST18i3 macho	965301
Conector Wieland 5 polos GST18i5 DIM macho	965403

¹ Preparado para telemando.

LUMINARIAS TUBULARES





Luminarias
tubulares

TALEA



TALEA
678



TALEA HRZ
678



TALEA Line
682



TALEA Glare /C
686



TALEA Glare
690



Tipos de aplicación

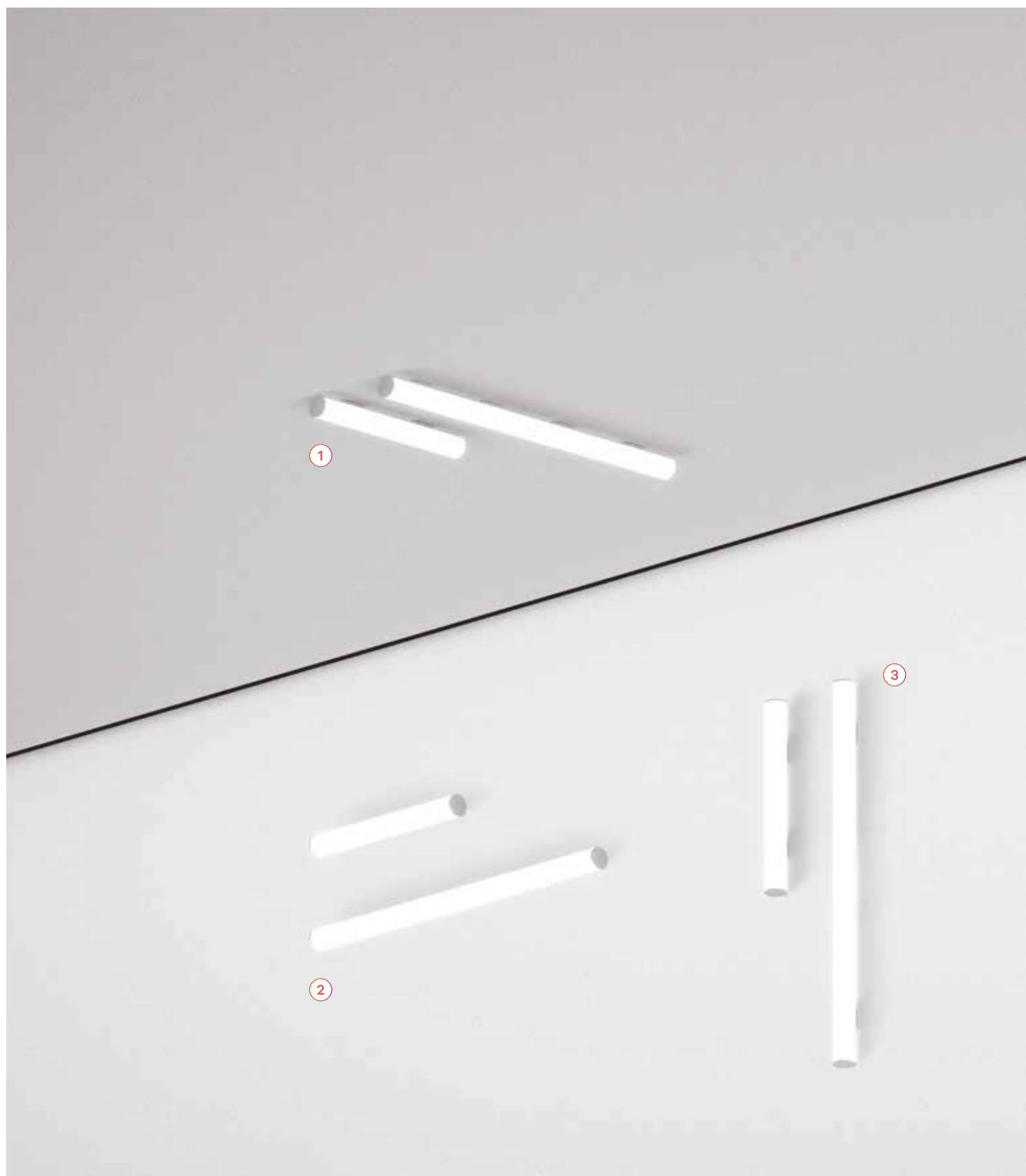



1. Superficie

2. Pared
Horizontal

3. Pared
Vertical

4. Suspendida



Sistema óptico

LUMINARIAS
TUBULARES

Escala 1:1

1

1. bLINE

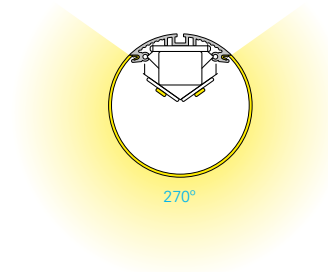
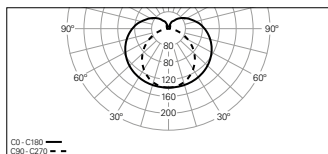

Composición de los elementos estructurales

1. Tapas

2. Módulos LED

- 2.1 Módulo inicial (SRT).
- 2.2 Módulo intermedio (MID).
- 2.3 Módulo final (END).

3. Difusor

4. Kit de unión

5. Base de techo

6. Cable de alimentación

7. Kit de fijación superficie

8. Suspensión

Módulos disponibles

(Vista desde arriba)

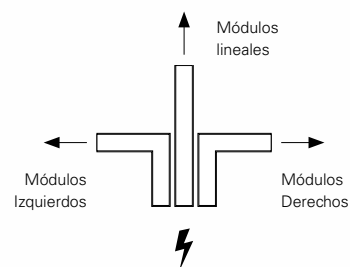

Cómo montar una línea

(Vista desde arriba)

— Tapas

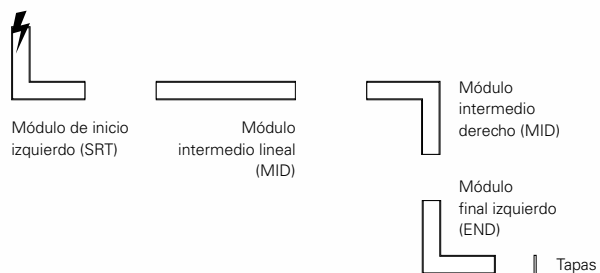

Defina su color

LUMINARIAS
TUBULARES

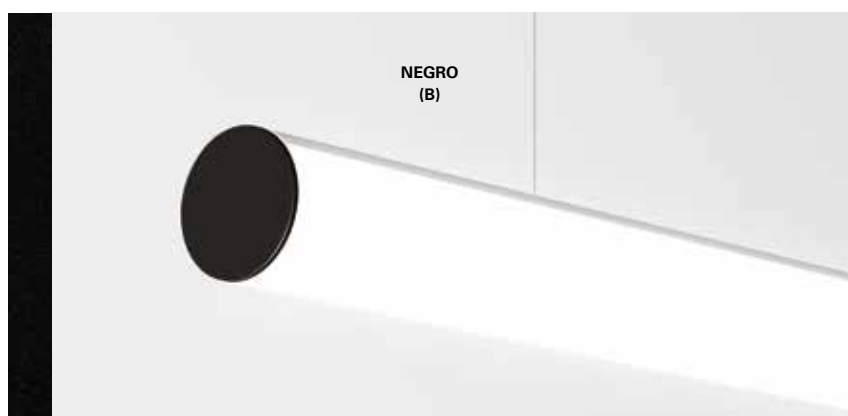
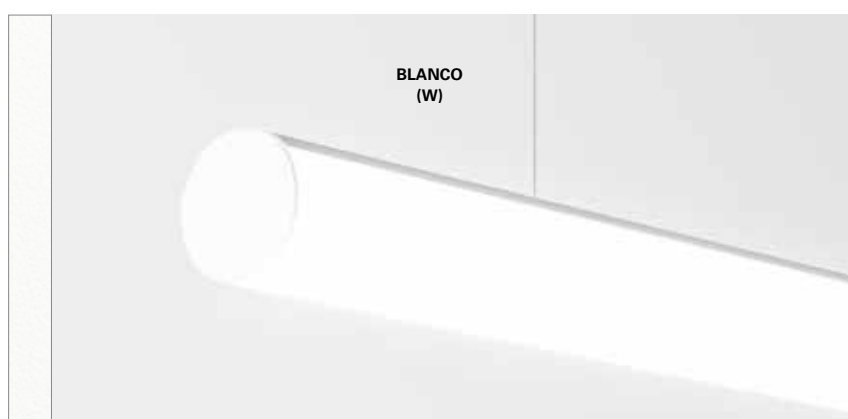



TALEA

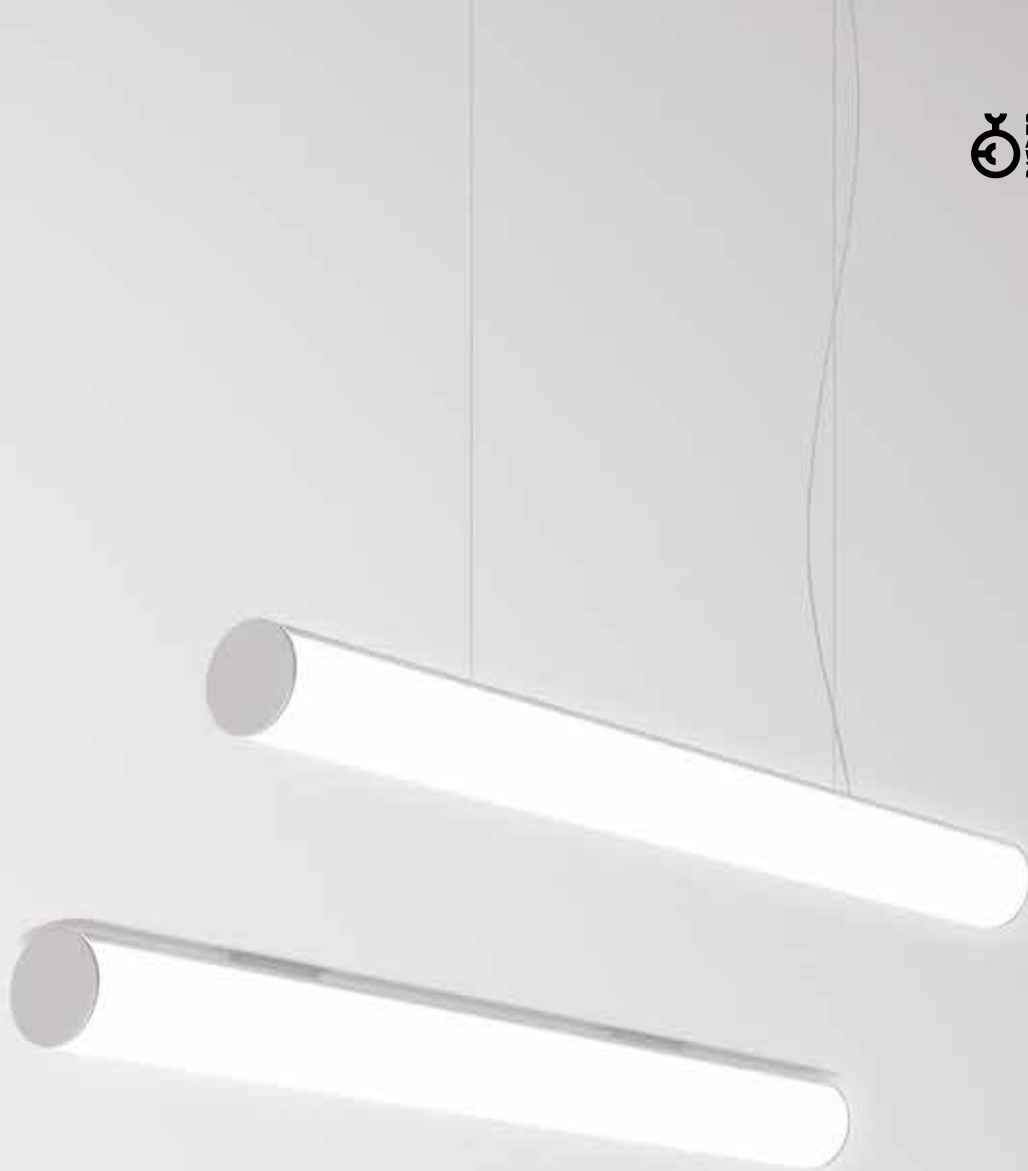

Características del producto

Cuerpo

Perfil de aluminio extruido



Tapas

Policarbonato inyectado

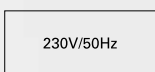

Acabado

Anodizado en color natural



Sistema óptico

bLINE - Difusor opalino



Cableado

Precableado con cable de alimentación transparente 1500 mm incluido

Fuente de luz

LED, RG1, CRI>80, MacAdam Step ≤3

Vida útil del LED

80.000h @ L90, B10, Ta 25°C

Fuente de alimentación

Driver LED 220-240V-50/60Hz incluido

01. Seleccionar versión



TALEA

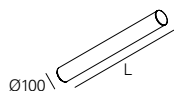

bLINE - Difusor opalino

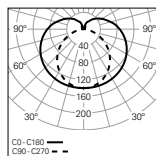

W	lm output	lm/W	Lmm	CÓDIGO*
19	2340	123	598	90438L220▼▲0♦00
27	3510	130	878	90438L230▼▲0♦00
35	4680	134	1158	90438L240▼▲0♦00
43	5850	136	1438	90438L250▼▲0♦00
54	7020	130	1718	90438L260▼▲0♦00
62	8190	132	1998	90438L270▼▲0♦00
70	9360	134	2278	90438L280▼▲0♦00
78	10530	135	2558	90438L290▼▲0♦00
86	11700	136	2838	90438L200▼▲0♦00

*Sustituya los símbolos para completar el código

Orientação ▲
LEFT L
RIGHT R

Fuente de alimentación ▼
HF E
DALI H

Color¹ ▲
□ Blanco W
■ Gris G
■ Negro B

Emergencia ●
No EM 0
EM 3h (K3)² 3

Temp. de color ♦
3000K 3
4000K 0

TALEA HRZ

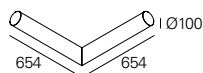

bLINE - Difusor opalino

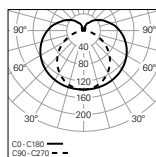

W	lm output	lm/W	CÓDIGO*
35	4680	134	90753▲220▼▲0♦00



TALEA

- Para la versión superficie es necesario un kit fijación superficie. Solicitelo por separado.
- Para la versión suspendida es necesario pedir la suspensión y la base de alimentación por separado.

¹ Color de las tapas.

² Kit de emergencia de 3 horas con autopruebas. Sólo disponible en las versiones HF.

02. Seleccionar opciones

OPCIONES	Código*
Kit de fijación superficie	
TALEA (x2)	926400
TALEA HRZ (x4)	926410
Suspensión	
• Para TALEA:	
S5 L1500 mm (x2)	910409
S5 L3000 mm (x2)	910412
S5 L6000 mm (x2)	910421
• Para TALEA HRZ:	
S5 L1500 mm (x3)	910423
S5 L3000 mm (x3)	910424
S5 L6000 mm (x3)	910425
Cable de alimentación	
L3000 mm - 3 x 0,75 mm ²	940401
L3000 mm - 5 x 0,75 mm ²	940501
L6000 mm - 3 x 0,75 mm ²	940402
L6000 mm - 5 x 0,75 mm ²	940507
Base circular	
Superficie T24 D95  Ø95	45 978600▲
Empotrar T5 D90  Ø70 33  Ø90	971300▲



*Sustituya los símbolos para completar el código

Color ▲
 Blanco W
 Negro B



Detalles del producto

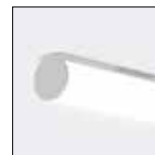

Aplicación de superficie

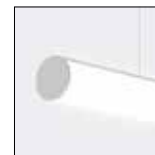

Aplicación suspendida



Aplicación de pared

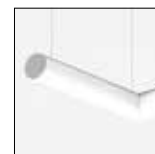

Talea HRZ



Difusor bLINE



Difusor clip-in



Uniformidad de la luz



Kit de fijación superficie



Bases de techo

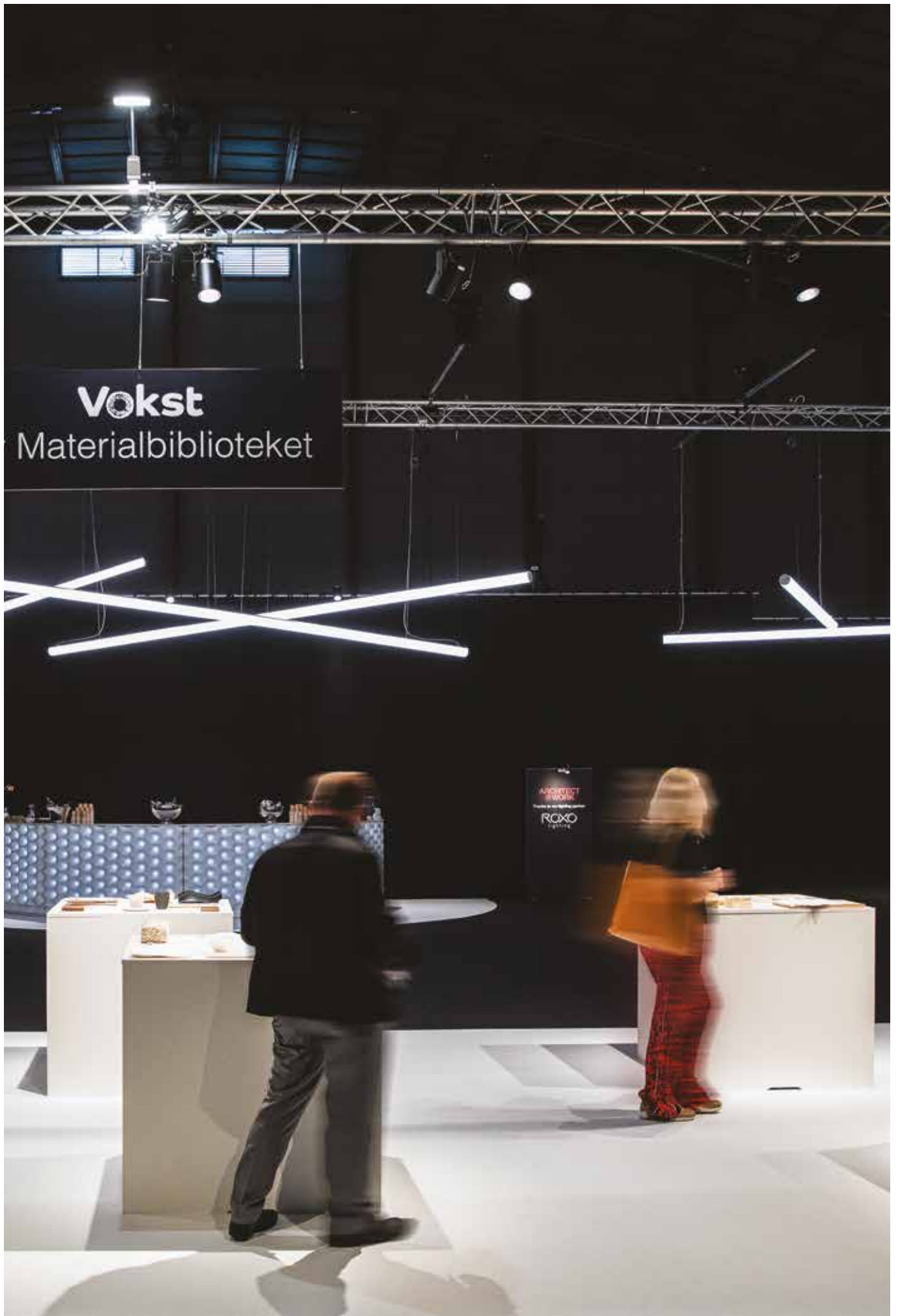

TALEA Line



Características del producto

Cuerpo

Perfil de aluminio extruido



Tapas

Policarbonato inyectado

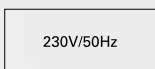

Acabado

Anodizado en color natural



Sistema óptico

bLINE - Difusor opalino

Cableado

Precableado con cable de alimentación transparente 1500 mm incluido en los módulos iniciales (SRT)



Fuente de luz

LED, RG1, CRI>80, MacAdam Step ≤ 3

Vida útil del LED

80.000h @ L90, B10, Ta 25°C

Fuente de alimentación

Driver LED 220-240V-50/60Hz incluido

01. Seleccionar versión



TALEA Line

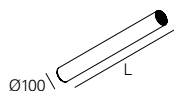

bLINE - Difusor opalino

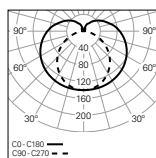

W	lm output	lm/W	Lmm	CÓDIGO*
19	2340	123	590	90439L220▼00♣♣
27	3510	130	870	90439L230▼00♣♣
35	4680	134	1150	90439L240▼00♣♣♣
43	5850	136	1430	90439L250▼00♣♣♣
54	7020	130	1710	90439L260▼00♣♣♣
62	8190	132	1990	90439L270▼00♣♣♣
70	9360	134	2270	90439L280▼00♣♣♣
78	10530	135	2550	90439L290▼00♣♣♣
86	11700	136	2830	90439L200▼00♣♣♣

*Sustituya los símbolos para completar el código

Orientação	▲
LEFT	L
RIGHT	R

Fuente de alimentación	▼
HF	E
DALI	H

Emergencia	●
No EM	0
EM 3h (K3) ¹	3

TALEA HRZ

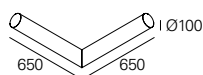

bLINE - Difusor opalino

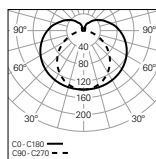

W	lm output	lm/W	CÓDIGO*
35	4680	134	90754▲220▼00♣♣

Temp. de color	◆
3000K	3
4000K	0

Módulo	♣
SRT	49
MID	00
END	50

MÓDULOS DISPONIBLES





Módulo inicial (SRT)
 Módulo intermedio (MID)
 Módulo final (END)

TALEA Line

- Para la versión superficie es necesario un kit fijación superficie. Solicítelo por separado.
- Para la versión suspendida es necesario pedir la suspensión y la base de alimentación por separado.
- Para completar una línea, es necesario un Start Kit y kit de unión. Por favor solicítelo por separado.
- Las dimensiones no incluyen el star kit. Incremente 8 mm a la longitud para completar la línea.

¹ Kit de emergencia de 3 horas con autopruebas. Sólo disponible en las versiones HF.

02. Seleccionar opciones

OPCIONES	Código*
Start kit - topo inicio/fim	
Blanco	922700
Gris	922701
Negro	922702
• Dois Tapas incluídos.	
Kit de unión	
HF (x1)	931801
HF + K3 (x1)	931802
DALI (x1)	931800
• Kit de unión en policarbonato inyectado.	
Kit de fijación	
TALEA (x2)	926400
TALEA HRZ (x4)	926410
Suspensión	
• Para TALEA:	
S5 L1500 mm (x2)	910409
S5 L3000 mm (x2)	910412
S5 L6000 mm (x2)	910421
• Para TALEA HRZ:	
S5 L1500 mm (x3)	910423
S5 L3000 mm (x3)	910424
S5 L6000 mm (x3)	910425
Cable de alimentación	
L3000 mm - 5 x 1,5 mm ²	940001
L6000 mm - 5 x 1,5 mm ²	940002
Base circular	
Superficie T24 D95  45 l  Ø95	978600♣
Empotrar T5 D90  Ø70 33 l  Ø90	971300♣



*Sustituya los símbolos para completar el código

Color 
 Blanco W
 Negro B



Detalles del producto

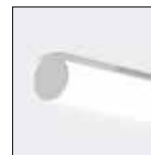

Aplicación de superficie

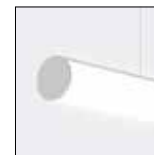

Aplicación suspendida



Aplicación de pared

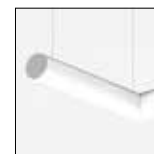

Talea HRZ



Difusor bLINE



Difusor clip-in



Uniformidad de la luz



Kit de fijación superficie



Bases de techo

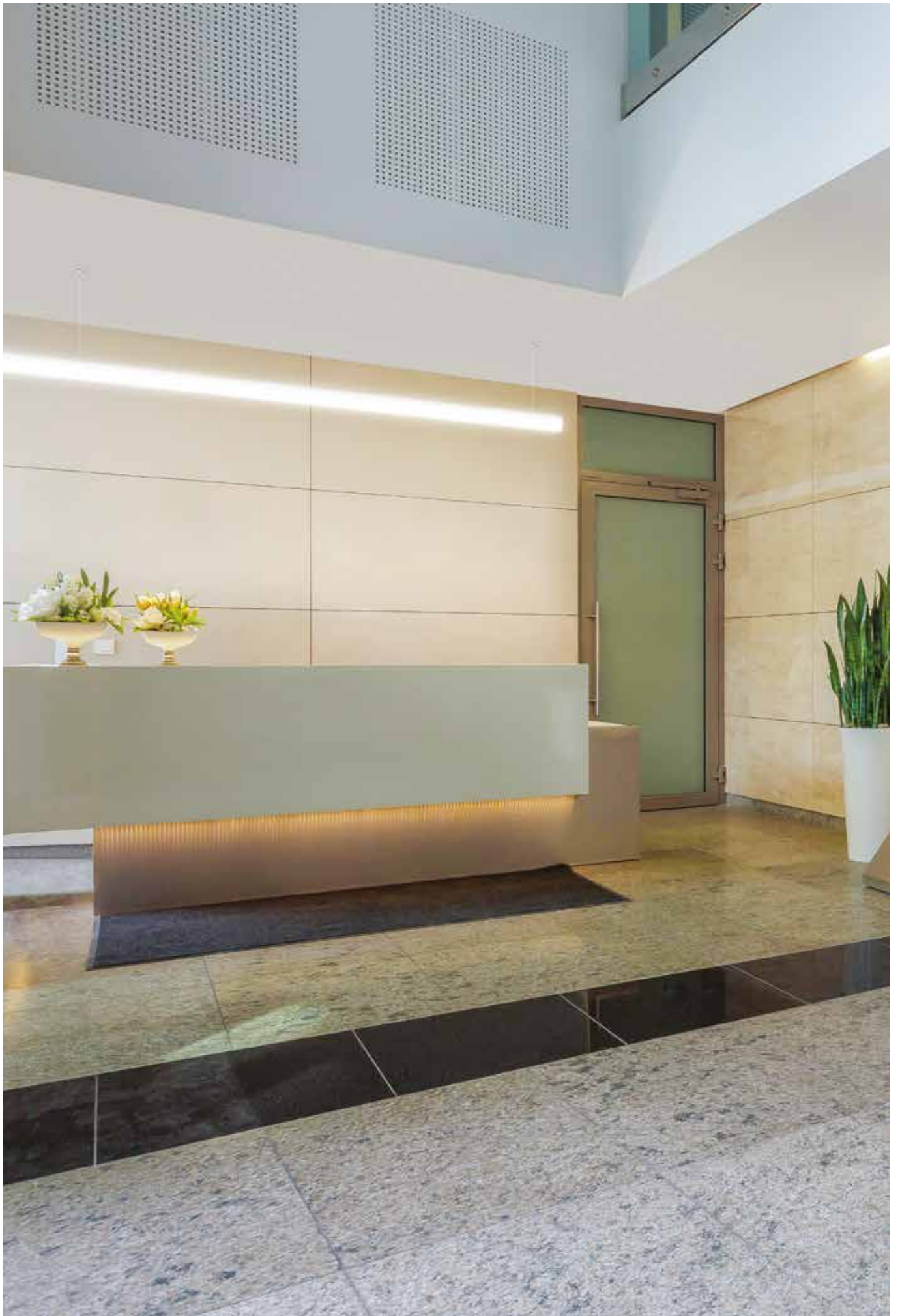

TALEA Glare /C



Características del producto

Cuerpo

Perfil de aluminio extruido



Tapas

Policarbonato inyectado

230V/50Hz

Acabado

Anodizado en color natural



IP 40

Sistema óptico

bLINE - Difusor opalino

Fuente de luz

LED, RG1, CRI>80, MacAdam Step ≤3

960°C

Vida útil del LED

80.000h @ L90, B10, Ta 25°C

Fuente de alimentación

Driver LED 220-240V-50/60Hz incluido

01. Seleccionar versión

TALEA Glare /C

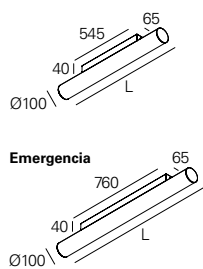

bLINE - Difusor opalino

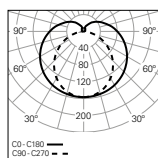

UGR	W	lm output	lm/W	Lmm	CÓDIGO*
≤19	15	1802	120	878	90429L130♥♣♦00
≤19	19	2402	126	1158	90429L140♥♣♦♦00
≤19	23	3003	131	1438	90429L150♥♣♦♦00
≤19	27	3604	133	1718	90429L160♥♣♦♦00
≤19	32	4204	131	1998	90429L170♥♣♦♦00
≤19	35	4805	137	2278	90429L180♥♣♦♦00
≤19	41	5405	132	2558	90429L190♥♣♦♦00
≤19	43	6006	140	2838	90429L100♥♣♦♦00



*Sustituya los símbolos para completar el código

Fuente de alimentación ▼

HF E
DALI H

Color¹ ♠

□ Blanco W
■ Gris G
■ Negro B

Emergencia ●

No EM 0
EM 3h (K3)² 3

Temp. de color ♦

3000K 3
4000K 0

Detalles del producto



Aplicación de superficie

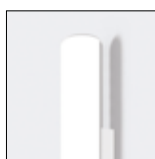

Aplicación de pared



Difusor bLINE



Difusor clip-in



Uniformidad de la luz

¹ Color de las tapas.

² Kit de emergencia de 3 horas con autopruebas. Sólo disponible en las versiones HF.





TALEA Glare



Características del producto

Cuerpo

Perfil de aluminio extruido



Tapas

Policarbonato inyectado

230V/50Hz

Acabado

Anodizado en color natural



IP 40

Sistema óptico

bLINE - Difusor opalino

Cableado

Precableado con cable de alimentación transparente 1500 mm incluido

960°C

Fuente de luz

LED, RG1, CRI>80, MacAdam Step ≤3

Vida útil del LED

80.000h @ L90, B10, Ta 25°C

Fuente de alimentación

No incluido

01. Seleccionar versión



TALEA Glare

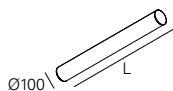

bLINE - Difusor opalino

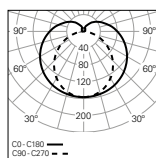

UGR	W	lm output	lm/W	Lmm	CÓDIGO*
≤19	15	1802	120	878	90428L1300♣♦00
≤19	19	2402	126	1158	90428L1400♣♦♦00
≤19	23	3003	131	1438	90428L1500♣♦♦00
≤19	27	3604	133	1718	90428L1600♣♦♦00
≤19	32	4204	131	1998	90428L1700♣♦♦00
≤19	35	4805	137	2278	90428L1800♣♦♦00
≤19	41	5405	132	2558	90428L1900♣♦♦00
≤19	43	6006	140	2838	90428L1000♣♦♦00

*Sustituya los símbolos para completar el código

Color ¹	
□ Blanco	W
■ Gris	G
■ Negro	B

Emergencia	
No EM	0
EM 3h (K3) ²	3

TALEA Glare

• Para completar el producto es necesario pedir la suspensión y la base de alimentación por separado.

Temp. de color	
3000K	3
4000K	0

02. Seleccionar base de alimentación

Empotrar - No EM

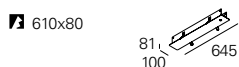

Empotrar - EM 3h (K3)

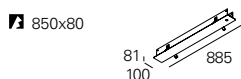

Superficie - No EM

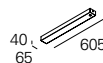

Superficie - EM 3h (K3)

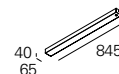

HF

	CÓDIGO*
L878	978401♣
L1158	978402♣
L1438	978403♣
L1718	978404♣
L1998	978405♣
L2278	978406♣
L2558	978407♣
L2838	978408♣

HF + EM 3h (K3)

	CÓDIGO*
L1158	978432♣
L1438	978433♣
L1718	978434♣
L1998	978435♣
L2278	978436♣
L2558	978437♣
L2838	978438♣

HF

	CÓDIGO*
L878	978201♣
L1158	978202♣
L1438	978203♣
L1718	978204♣
L1998	978205♣
L2278	978206♣
L2558	978207♣
L2838	978208♣

HF + EM 3h (K3)

	CÓDIGO*
L1158	978232♣
L1438	978233♣
L1718	978234♣
L1998	978235♣
L2278	978236♣
L2558	978237♣
L2838	978238♣

DALI

	CÓDIGO*
L878	978501♣
L1158	978502♣
L1438	978503♣
L1718	978504♣
L1998	978505♣
L2278	978506♣
L2558	978507♣
L2838	978508♣

DALI + EM 3h (K3)

	CÓDIGO*
L1158	978532♣
L1438	978533♣
L1718	978534♣
L1998	978535♣
L2278	978536♣
L2558	978537♣
L2838	978538♣

DALI

	CÓDIGO*
L878	978301♣
L1158	978302♣
L1438	978303♣
L1718	978304♣
L1998	978305♣
L2278	978306♣
L2558	978307♣
L2838	978308♣

DALI + EM 3h (K3)

	CÓDIGO*
L1158	978332♣
L1438	978333♣
L1718	978334♣
L1998	978335♣
L2278	978336♣
L2558	978337♣
L2838	978338♣

BASE DE TECHO

- Driver incluido en la base de techo.
- La distancia máxima entre la base de techo y el producto es de 3000 mm.

¹ Color de las tapas.

² Preparado para telemando.

03. Seleccionar opciones

OPCIONES	Código
Suspensión	
S5 L1500 mm (x2)	910409
S5 L3000 mm (x2)	910412
Cable de alimentación	
• HF/DALI L3000 mm - 2 x 0,75 mm ²	942801
• HF/DALI + EM 3h (K3) L3000 mm - 5 x 0,75 mm ²	940501



Detalles del producto

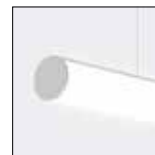

Aplicación suspendida



Difusor bLINE



Difusor clip-in



Uniformidad de la luz



Bases de techo



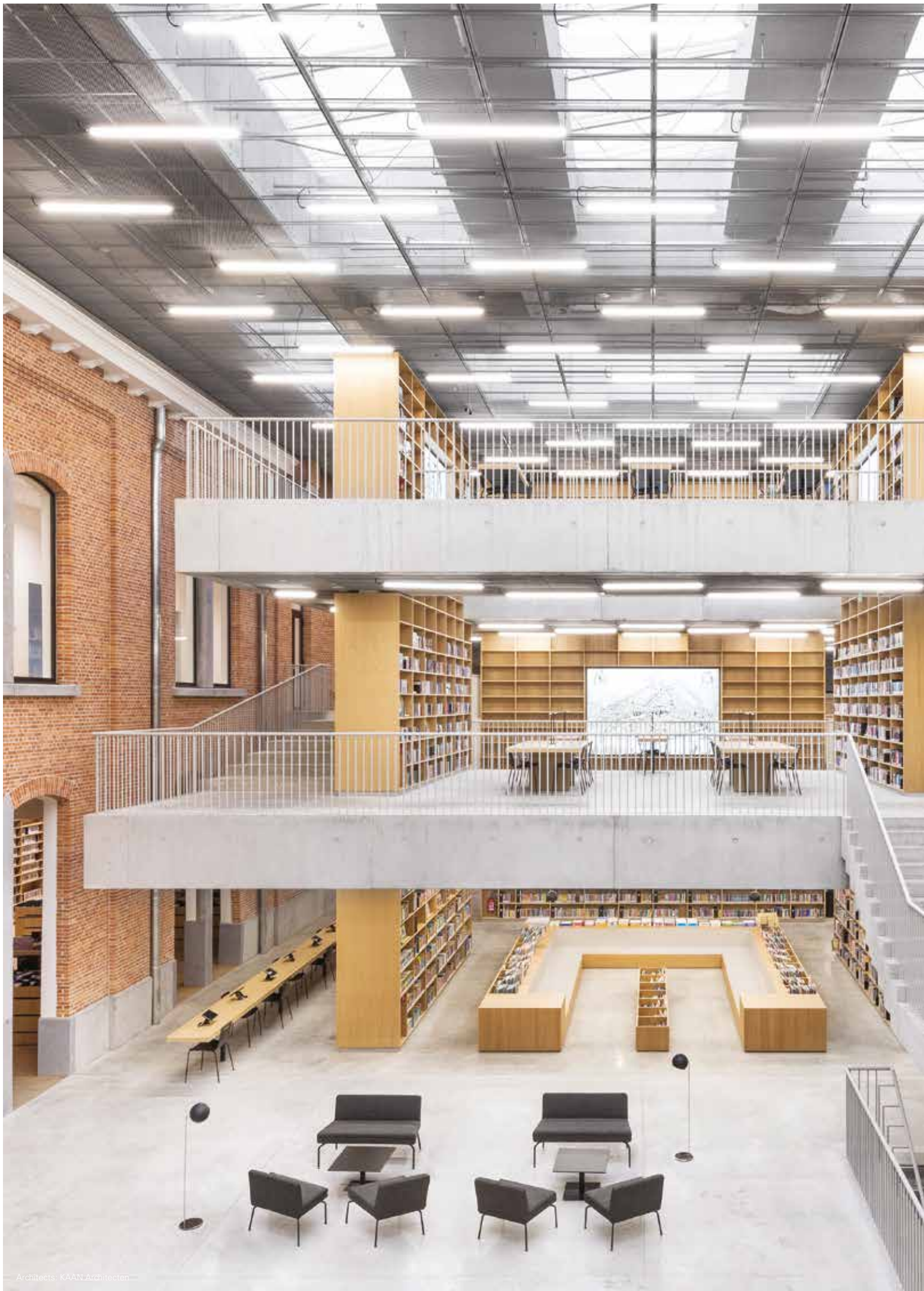

Luminarias
tubulares

TTP



TTP 50
708



TTP 50 Line
712



TTP 70
716



TTP 70 Line
720



TTP 100
724



TTP 100 Line
728



Tipos de aplicación

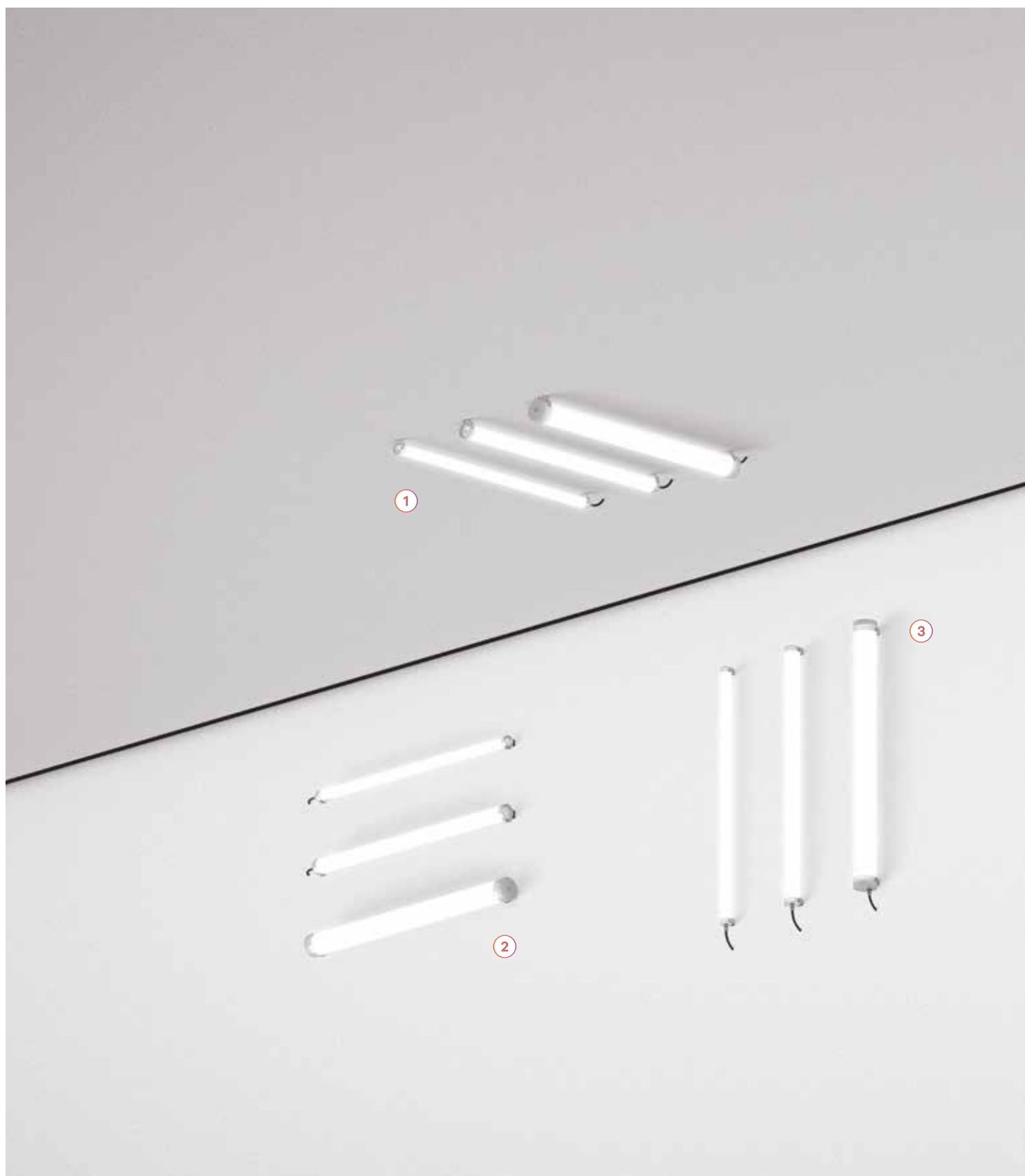

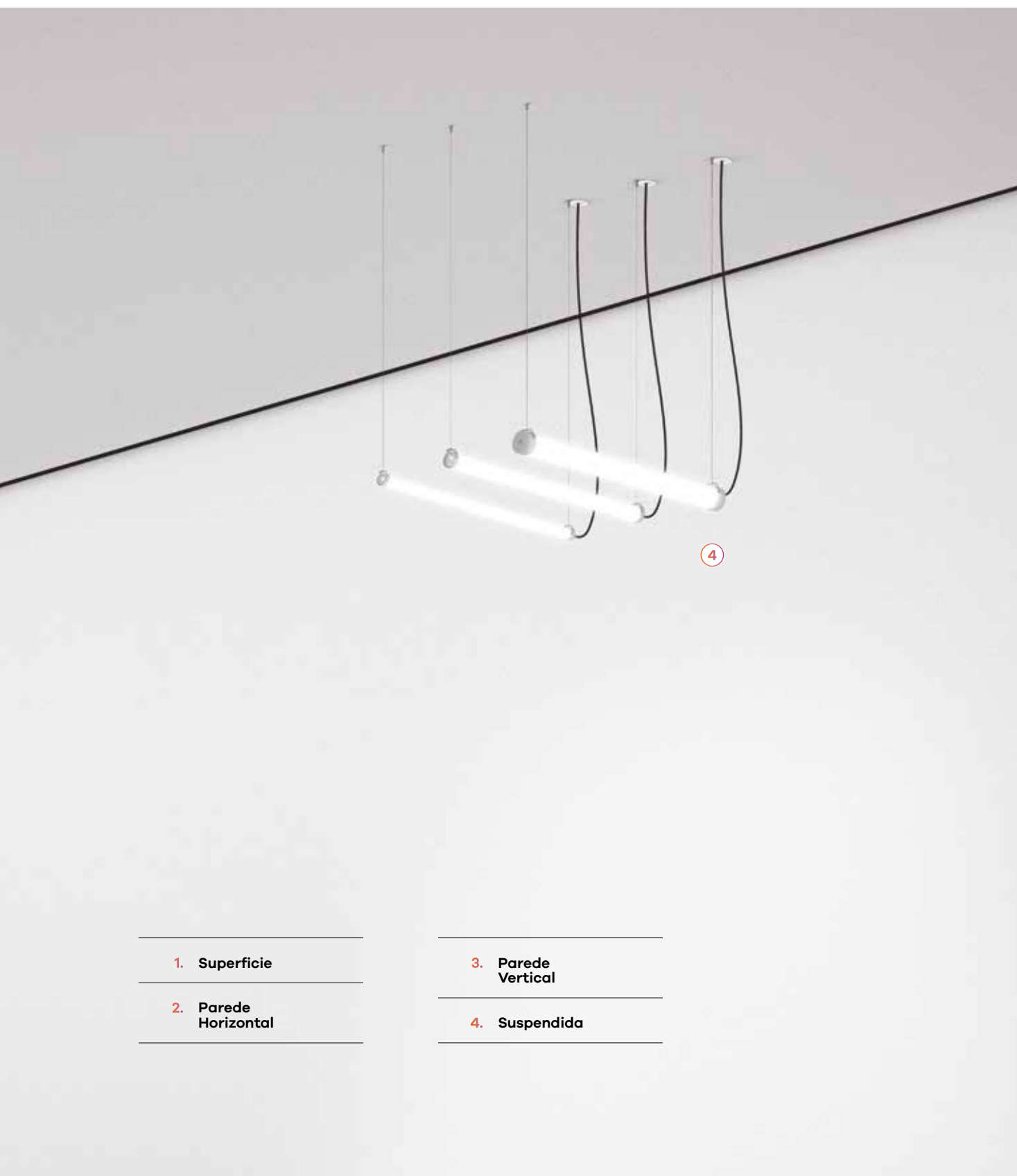

1. Superficie

2. Parede
Horizontal

3. Parede
Vertical

4. Suspendida

Una elección versátil para su proyecto



TTP 50
≈ Ø50 mm



TTP 70
≈ Ø70 mm



TTP 100
≈ Ø100 mm



	TTP 50	TTP 50 Line	TTP 70	TTP 70 Line	TTP 100	TTP 100 Line
MEDIDAS	≈ Ø50 mm	≈ Ø50 mm	≈ Ø70 mm	≈ Ø70 mm	≈ Ø100 mm	≈ Ø100 mm
≈650 mm	•	•	•	•	•	•
≈900 mm	•	•	•	•	•	•
≈1200 mm	•	•	•	•	•	•
≈1500 mm	•	•	•	•	•	•
Sensor						
≈750 mm	•		•		•	
≈830 mm		•		•		•
≈1040 mm	•		•		•	
≈1110 mm		•		•		•
≈1320 mm	•		•		•	
≈1390 mm		•		•		•
≈1600 mm	•		•		•	
≈1670 mm		•		•		•



1. TUP

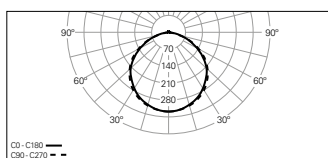

2. TOP

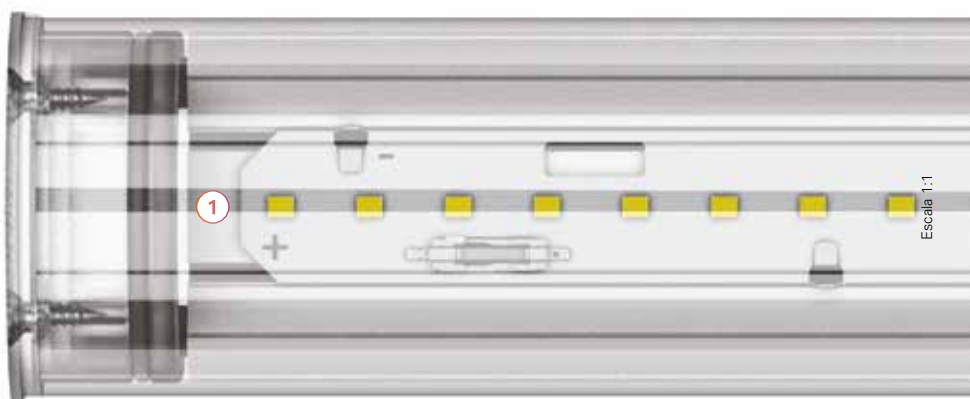
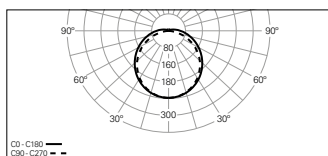

Minimalismo y tecnología

1. Versión estándar

Versiones individuales precableados con cable H07RN-F de 1500 mm y prensaestopas plástico. Cable de alimentación no incluido para las versiones de línea continua.

2. Tapas

Los modelos TTP 50 y TTP 70 están disponibles con tapas de policarbonato transparente inyectado o de acero inoxidable. TTP 100 está disponible con tapas de aluminio o acero inoxidable.



3. Prensaestopas opcionales

- 3.1 Prensaestopas metálico
- 3.2 Prensaestopas metálico ventilado

4. Abrazaderas

- 4.1 Abrazadera en PVC
- 4.2 Abrazadera inox con clip
- 4.3 Abrazadera inox A1
- 4.4 Abrazadera inox A2
- 4.5 Abrazadera inox con cierre

Todas las abrazaderas pueden ser utilizadas para aplicaciones de superficie, suspendidas o de pared.

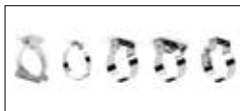

5. Suspensión y base de alimentación

Suspensiones ajustables de 1500, 3000 o 6000 mm compatibles con todas las abrazaderas disponibles. Bases de alimentación de empotrar o de superficie disponibles en blanco o negro.



- **LED**
SDCM MacAdam ≤ 3 , temperatura de color 3000K / 4000K, CRI > 80 y vida útil de 80.000h L90 B10.

- **Tunable White**
Versiones Tunable White disponibles con un espectro de blancos de 2700K a 6500K.



- **TUP u TOP**
Sistema óptico de alta tecnología con versión transparente (TUP) u opalino (TOP) para una luz suave y uniforme sin manchas visibles.



- **Kit de Emergencia**
Kit de emergencia de 3 horas. Disponible en versiones HF a partir de 1180 mm.

- **Exento de riesgo fotobiológico**
Grupo de riesgo fotobiológico 0 según IEC 62471.

• Marcas / Certificaciones





Descubra los detalles

- **Flexibilidad de líneas continuas**

Versiones de línea continua disponibles para TTP 50, 70 y 100, permitiendo hasta 35 luminarias por línea. Disponible en luminarias iniciales/intermedias (SRT/MID) equipadas con dos prensaestopas y luminarias finales (END) equipadas con un prensaestopas.

- **Índice de protección (IP)**

Gracias al IP68, las luminarias están totalmente protegidas contra el polvo y los efectos prolongados de inmersión a baja presión. Luminarias con IK10, que garantiza una protección contra impactos mecánicos de hasta 20 julios.

- **Versiones HO y LO disponibles**

Todas las luminarias están disponibles en versión low output (LO) de hasta 163 lm/W y high output (HO) de hasta 142 lm/W.

- **Sensor**

Sensor de presencia disponible para versiones individuales o línea continua. En una línea continua, sólo la primera luminaria incluye un sensor que se comunica con hasta 16 luminarias por línea.

Módulos disponibles

(Vista desde arriba)

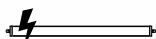

Módulo inicio / intermedio (SRT/MID)

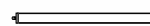

Módulo finales (END)

Cómo montar una línea

(Vista desde arriba)

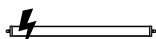

Módulo inicio / intermedio (SRT/MID)

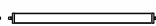

Módulo inicio / intermedio (SRT/MID)

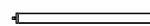

Módulo finales (END)



Superficie o pared



Suspendida



Sensor





Architects: KAAAN Architecten



TTP 50



Características del producto

Cuerpo

Tubo de policarbonato



Acabado

Interior pintado con epoxi poliéster blanco mate



Sistema de fijación

Abrazaderas no incluidas

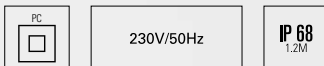

Sistema óptico

TUP - Difusor transparente
TOP - Difusor opalino

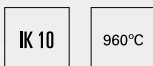

Cableado

Cable H07RN-F de 1500 mm con prensaestopas plástico incluido

Fuente de luz

LED, RG0, CRI>80, MacAdam Step ≤3

Vida útil del LED

80.000h @ L90, B10, Ta 25°C

Fuente de alimentación

Driver LED 220-240V-50/60Hz incluido

01. Seleccionar versión



LOW OUTPUT

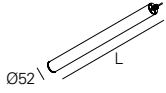

TUP - Difusor transparente

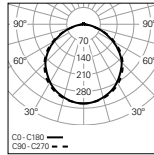

W	lm output	lm/W	Lmm	CÓDIGO*
12	1868	156	620	90473L060▼▲0◆00
17	2802	165	900	90473L090▼▲0◆00
21	3735	178	1180	90473L120▼▲0◆00
26	4669	180	1460	90473L150▼▲0◆00

TOP - Difusor opalino

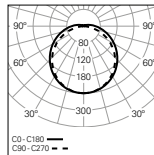

W	lm output	lm/W	Lmm	CÓDIGO*
12	1573	131	620	90472L060▼▲0◆00
17	2359	139	900	90472L090▼▲0◆00
21	3146	150	1180	90472L120▼▲0◆00
26	3932	151	1460	90472L150▼▲0◆00

*Sustituya los símbolos para completar el código

Fuente de alimentación ▼
HF E
DALI H

Tapas ▲
Policarbonato ¹ 0
Inox ² S

Emergencia ●
No EM 0
EM 3h (K3) ³ 3

Temp. de color ◆
3000K 3
4000K 0
Tunable White ⁴ T

HIGH OUTPUT

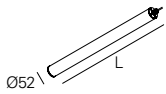

TUP - Difusor transparente

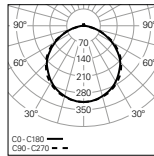

W	lm output	lm/W	Lmm	CÓDIGO*
26	3982	153	620	90471L060▼▲0◆00
40	5973	149	900	90471L090▼▲0◆00
51	7964	156	1180	90471L120▼▲0◆00
63	9954	158	1460	90471L150▼▲0◆00

TOP - Difusor opalino

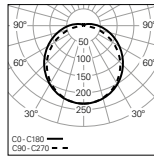

W	lm output	lm/W	Lmm	CÓDIGO*
26	3419	132	620	90470L060▼▲0◆00
40	5129	128	900	90470L090▼▲0◆00
51	6838	134	1180	90470L120▼▲0◆00
63	8548	136	1460	90470L150▼▲0◆00

LOW OUTPUT | HIGH OUTPUT

- Para completar el producto es necesario pedir el sistema de fijación por separado.
- Para la versión suspendida es necesario pedir la suspensión y la base de alimentación por separado.
- La luminaria con sensor es 130 mm más larga que la medida estándar.







¹ Tapas en policarbonato inyectado transparente. El producto es clase II.

² Tapas en inox. El producto es clase I.

³ Kit de emergencia de 3 horas con autopruebas. Sólo disponible en las versiones HF.

⁴ Sólo disponible en versiones DALI sin kit de emergencia (No EM).

02. Seleccionar opciones

OPCIONES	Código*
SwitchDIM Tunable White • El SwitchDIM Tubale White permite el control de 20 luminarias como máximo.	926600
Sistema de fijación	
Abrazadera PVC D50 (x2)  26 69 17	915001
Abrazadera inox D50 clip (x2)  14 60 10	915003
Abrazadera inox A1 D50 (x2)  36 65 20	915303
Abrazadera inox A2 D50 (x2)  56 63 20	915305
Abrazadera inox con cierre D50 (x2)  29 67 20	915304
Suspensión S4 L1500 mm (x2)	910200
Base de techo ¹	
Superficie T24 D95  45 Ø95	978600▲
Empotrar T5 D90  Ø70 33 Ø90	971300▲
Prensaestopas para versiones HF	
Metálico M16 (x1)	925000
Metálico ventilado M16 (x1)	926700
Prensaestopas para versiones DALI	
Metálico M20 (x1)	925001
Metálico ventilado M20 (x1)	926701
Sensor • Mediante solicitud. • Área de detección: 100%. Tiempo de espera: 5 segundos. Límite de luz diurna: desactivado. Para otras programaciones consulte el manual del sensor.	
Sensor e kit de Emergencia (3 Horas) • Mediante solicitud.	



*Sustituya los símbolos para completar el código

Color
 Blanco W
 Negro B



Detalles del producto



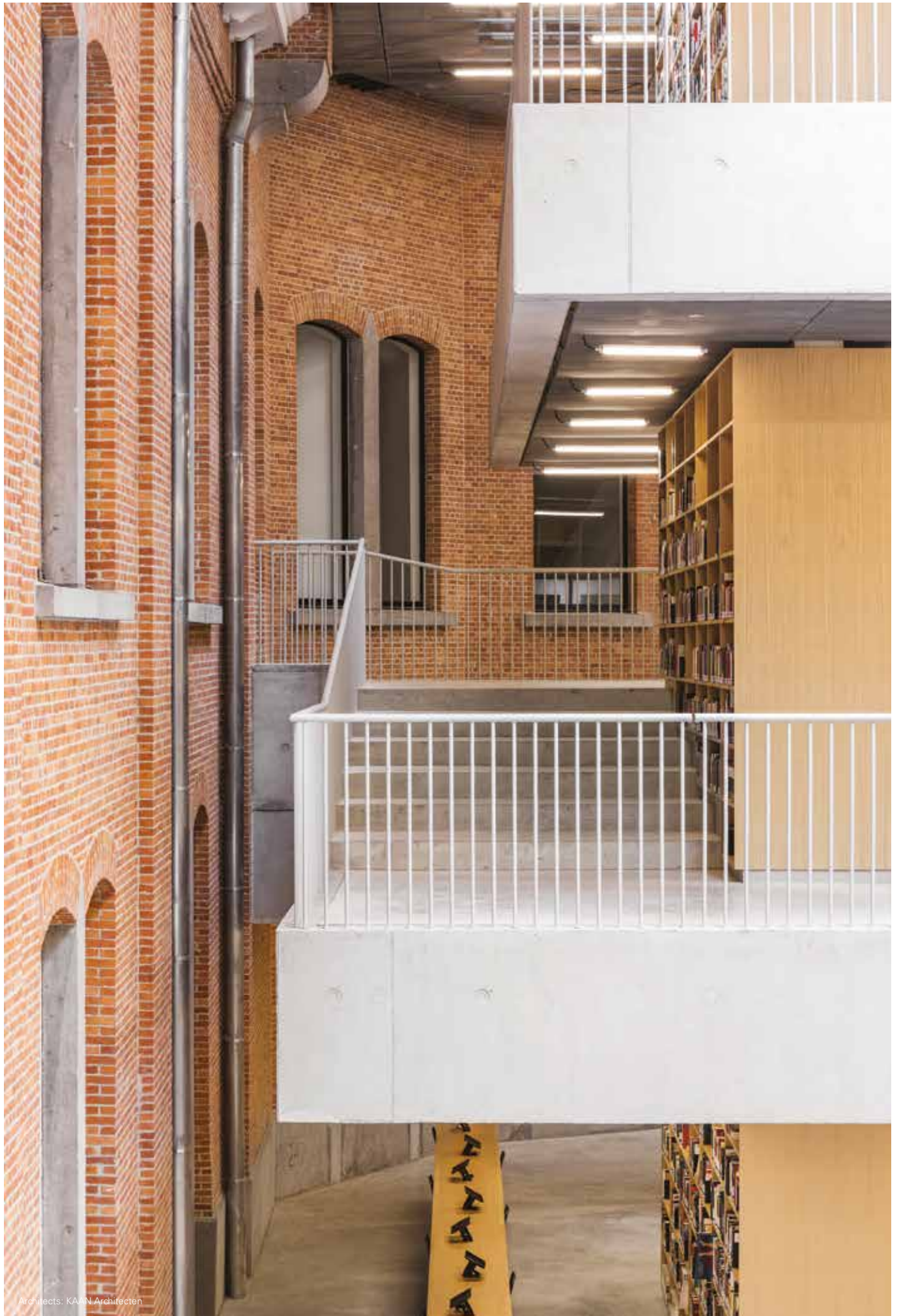

Architects: KAAN Architecten

TTP 50 Line



Características del producto

Cuerpo

Tubo de policarbonato

Acabado

Interior pintado con epoxi poliéster blanco mate

Sistema de fijación

Abrazaderas no incluidas

Sistema óptico

TUP - Difusor transparente
TOP - Difusor opalino

Cableado

Prensaestopas plástico e Cableado interna de linha continua incluído
Cable H07RN-F de 1500 mm no incluido

Fuente de luz

LED, RG0, CRI>80, MacAdam Step ≤3

Vida útil del LED

80.000h @ L90, B10, Ta 25°C

Fuente de alimentación

Driver LED 220-240V-50/60Hz incluído

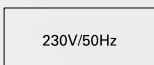

01. Seleccionar versión



LOW OUTPUT

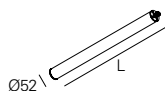

TUP - Difusor transparente

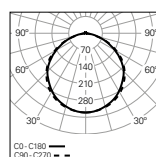

W	lm output	lm/W	Lmm	CÓDIGO*
12	1868	156	620	90485L060▼▲0◆♣
17	2802	165	900	90485L090▼▲0◆♣
21	3735	178	1180	90485L120▼▲0◆♣
26	4669	180	1460	90485L150▼▲0◆♣

TOP - Difusor opalino

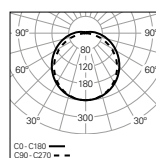

W	lm output	lm/W	Lmm	CÓDIGO*
12	1573	131	620	90484L060▼▲0◆♣
17	2359	139	900	90484L090▼▲0◆♣
21	3146	150	1180	90484L120▼▲0◆♣
26	3932	151	1460	90484L150▼▲0◆♣

*Sustituya los símbolos para completar el código

Fuente de alimentación ▼
HF E
DALI H

Tapas ▲
Policarbonato¹ 0
Inox² S

Temp. de color ◆
3000K 3
4000K 0
Tunable White³ T

Módulo ♣
SRT/MID 58
END 50

HIGH OUTPUT

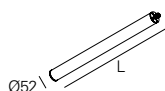

TUP - Difusor transparente



W	lm output	lm/W	Lmm	CÓDIGO*
26	3982	153	620	90483L060▼▲0◆♣
40	5973	149	900	90483L090▼▲0◆♣
51	7964	156	1180	90483L120▼▲0◆♣
63	9954	158	1460	90483L150▼▲0◆♣

TOP - Difusor opalino

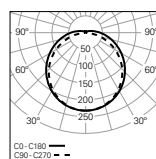

W	lm output	lm/W	Lmm	CÓDIGO*
26	3419	132	620	90482L060▼▲0◆♣
40	5129	128	900	90482L090▼▲0◆♣
51	6838	134	1180	90482L120▼▲0◆♣
63	8548	136	1460	90482L150▼▲0◆♣

MÓDULOS DISPONIBLES

◀ Módulo inicial / intermedio (SRT/MID) ▶ Módulo final (END)

LOW OUTPUT | HIGH OUTPUT







- Para completar el producto es necesario pedir el sistema de fijación por separado.
- Para la versión suspendida es necesario pedir la suspensión y la base de alimentación por separado.
- La luminaria con sensor es 215 mm más larga que la medida estándar.
- El número máximo de luminarias High Output que se pueden conectar en línea es 15. Con sensor el número máximo es 9.
- El número máximo de luminarias Low Output que se pueden conectar en línea es 35. Con sensor el número máximo es 16.

¹ Tapas en policarbonato inyectado transparente. El producto es clase II.

² Tapas en inox. El producto es clase I.

³ Sólo disponible en versiones DALI. Para longitudes L620 y L900 mm, Tunable White solo se aplica a las versiones de final de línea (END).

02. Seleccionar opciones

OPCIONES	Código*
SwitchDIM Tunable White • El SwitchDIM Tubale White permite el control de 20 luminarias como máximo.	926600
Sistema de fijación	
Abrazadera PVC D50 (x2)  26 69 17	915001
Abrazadera inox D50 clip (x2)  14 60 10	915003
Abrazadera inox A1 D50 (x2)  36 65 20	915303
Abrazadera inox A2 D50 (x2)  56 63 20	915305
Abrazadera inox con cierre D50 (x2)  29 67 20	915304
Suspensión	
S4 L1500 mm (x2)	910200
S4 L3000 mm (x2)	910204
S4 L6000 mm (x2)	910208
Base de techo¹	
Superficie T24 D95  45 Ø95	978600♣
Empotrar T5 D90  Ø70 33 Ø90	971300♣
Prensaestopas para versiones HF	
• Para todos los módulos inicial/intermedio (SRT/MID):	
Metálico M16 (x2)	925010
Metálico ventilado M16 (x2)	926710
• Para todos los módulos finales (END):	
Metálico M16 (x1)	925000
Metálico ventilado M16 (x1)	926700
Prensaestopas para versiones DALI	
• Para todos los módulos inicial/intermedio (SRT/MID):	
Metálico M20 (x2)	925011
Metálico ventilado M20 (x2)	926711
• Para todos los módulos finales (END):	
Metálico M20 (x1)	925001
Metálico ventilado M20 (x1)	926701
Sensor	
• Mediante solicitud.	
• Área de detección: 100%. Tiempo de espera: 5 segundos. Límite de luz diurna: desactivado. Para otras programaciones consulte el manual del sensor.	



*Sustituya los símbolos para completar el código

Color

Blanco W

Negro B



Detalles del producto



Aplicación de superficie

Aplicación suspendida

Aplicación de pared

Difusor opalino

Difusor transparente

Tapas de policarbonato transparente

Tapas inox

Abrazadera PVC D50

Abrazadera inox D50clip

Abrazadera inox A1 D50

Abrazadera inox A2 D50

Abrazadera inox D50com fecho

Bases de techo

Prensaestopas plástico

Prensaestopas metálico

Prensaestopas metálico ventilado

Sensor



TTP 70



Características del producto

Cuerpo

Tubo de policarbonato

Acabado

Interior pintado con epoxi poliéster blanco mate

Sistema de fijación

Abrazaderas no incluidas

Sistema óptico

TUP - Difusor transparente
TOP - Difusor opalino

Cableado

Cable H07RN-F de 1500 mm con prensaestopas plástico incluido

Fuente de luz

LED, RG0, CRI>80, MacAdam Step ≤3

Vida útil del LED

80.000h @ L90, B10, Ta 25°C

Fuente de alimentación

Driver LED 220-240V-50/60Hz incluido

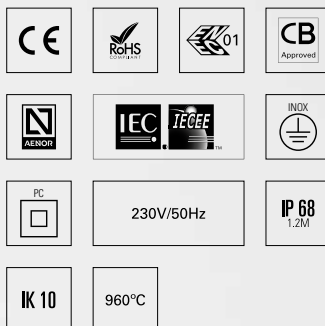

01. Seleccionar versión



LOW OUTPUT

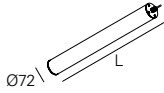

TUP - Difusor transparente

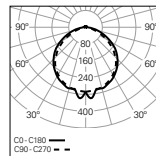

W	lm output	lm/W	Lmm	CÓDIGO*
12	1789	149	620	90477L060▼▲0◆00
17	2684	158	900	90477L090▼▲0◆00
21	3578	170	1180	90477L120▼▲0◆00
26	4473	172	1460	90477L150▼▲0◆00

TOP - Difusor opalino

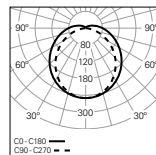

W	lm output	lm/W	Lmm	CÓDIGO*
12	1691	141	620	90476L060▼▲0◆00
17	2536	149	900	90476L090▼▲0◆00
21	3382	161	1180	90476L120▼▲0◆00
26	4227	163	1460	90476L150▼▲0◆00

*Sustituya los símbolos para completar el código

Fuente de alimentación ▼
HF E
DALI H

Tapas ▲
Policarbonato¹ 0
Inox² S

Emergencia ●
No EM 0
EM 3h (K3)³ 3

Temp. de color ◆
3000K 3
4000K 0
Tunable White⁴ T

HIGH OUTPUT

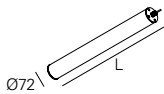

TUP - Difusor transparente

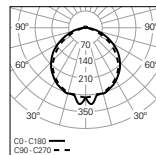

W	lm output	lm/W	Lmm	CÓDIGO*
26	3765	145	620	90475L060▼▲0◆00
40	5648	141	900	90475L090▼▲0◆00
51	7531	148	1180	90475L120▼▲0◆00
63	9413	149	1460	90475L150▼▲0◆00

TOP - Difusor opalino

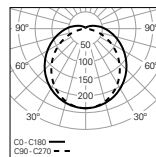

W	lm output	lm/W	Lmm	CÓDIGO*
26	3506	135	620	90474L060▼▲0◆00
40	5259	131	900	90474L090▼▲0◆00
51	7011	137	1180	90474L120▼▲0◆00
63	8764	139	1460	90474L150▼▲0◆00

LOW OUTPUT | HIGH OUTPUT

- Para completar el producto es necesario pedir el sistema de fijación por separado.
- Para la versión suspendida es necesario pedir la suspensión y la base de alimentación por separado.
- La luminaria con sensor es 130 mm más larga que la medida estándar.

¹ Tapas en policarbonato inyectado transparente. El producto es clase II.

² Tapas en inox. El producto es clase I.

³ Kit de emergencia de 3 horas con autopruebas. Sólo disponible en las versiones HF.

⁴ Sólo disponible en versiones DALI sin kit de emergencia (No EM).

02. Seleccionar opciones

OPCIONES	Código*
SwitchDIM Tunable White • El SwitchDIM Tubale White permite el control de 20 luminarias como máximo.	926600
Sistema de fijación	
Abrazadera inox A1 D70 (x2) 	915403
Abrazadera inox A2 D70 (x2) 	915405
Abrazadera inox D70 com fecho (x2) 	915404
Suspensión	
S4 L1500 mm (x2)	910200
Base de techo ¹	
Superficie T24 D95  Ø95	978600▲
Empotrar T5 D90  Ø70 33 Ø90	971300▲
Prensaestopas para versiones HF	
Metálico M16 (x1)	925000
Metálico ventilado M16 (x1)	926700
Prensaestopas para versiones DALI	
Metálico M20 (x1)	925001
Metálico ventilado M20 (x1)	926701
Sensor	
• Mediante solicitud. • Área de detección: 100%. Tiempo de espera: 5 segundos. Límite de luz diurna: desactivado. Para otras programaciones consulte el manual del sensor.	
Sensor e kit de Emergencia (3 Horas)	
• Mediante solicitud.	



*Sustituya los símbolos para completar el código

Color ▲
 Blanco W
 Negro B



Detalles del producto



Aplicación de superficie



Aplicación suspendida



Aplicación de pared



Difusor opalino



Difusor transparente



Tapas de policarbonato transparente



Tapas inox



Abrazadera inox A1 D70



Abrazadera inox A2 D70



Abrazadera inox D70 com fecho



Bases de techo



Prensaestopas plástico com fecho



Prensaestopas metálico



Prensaestopas metálico ventilado



Sensor

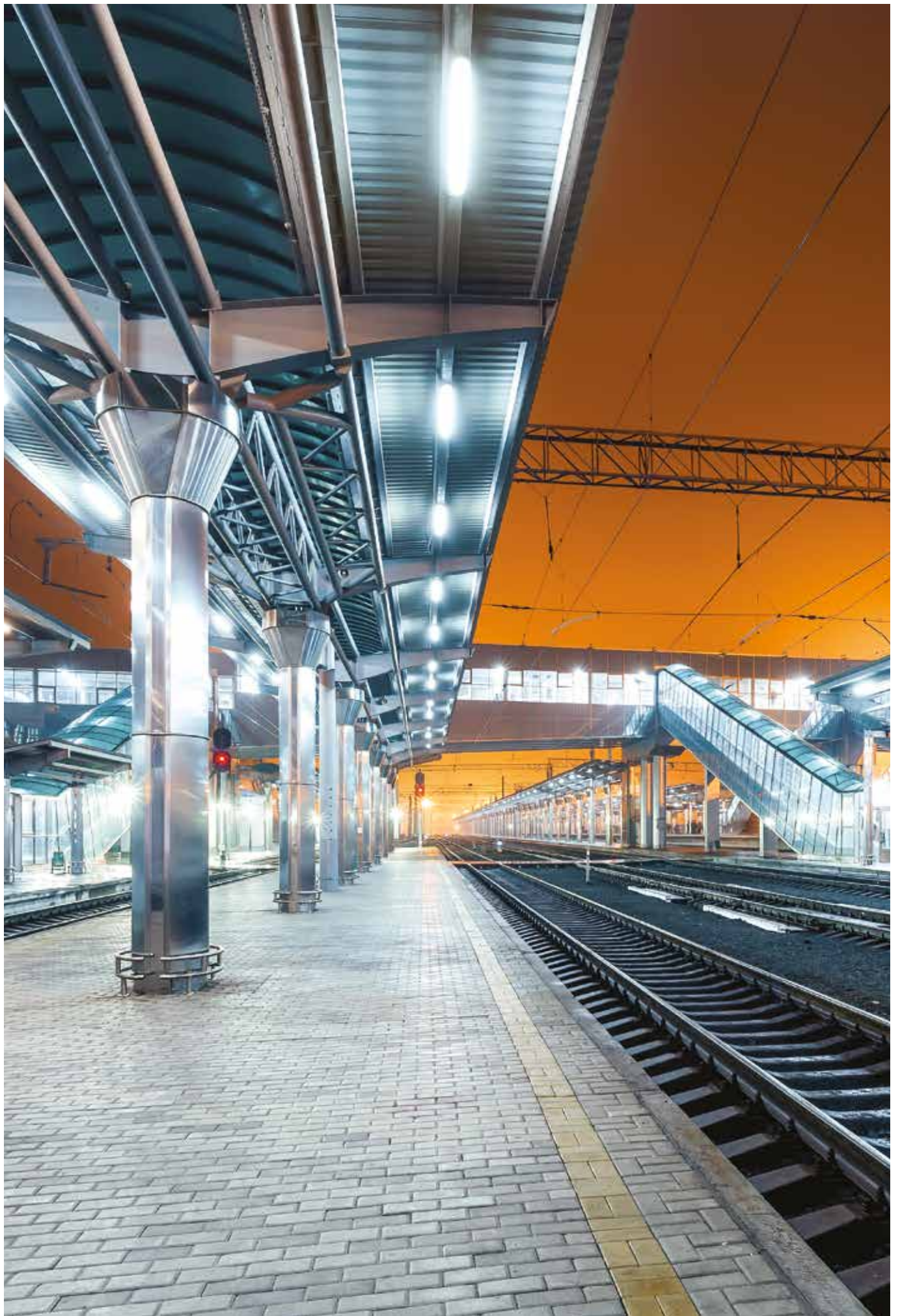

TTP 70 Line



Características del producto

Cuerpo

Tubo de policarbonato

Acabado

Interior pintado con epoxi poliéster blanco mate

Sistema de fijación

Abrazaderas no incluidas

Sistema óptico

TUP - Difusor transparente
TOP - Difusor opalino

Cableado

Prensaestopas plástico e Cableado interna de linha continua incluído
Cable H07RN-F de 1500 mm no incluido

Fuente de luz

LED, RG0, CRI>80, MacAdam Step ≤3

Vida útil del LED

80.000h @ L90, B10, Ta 25°C

Fuente de alimentación

Driver LED 220-240V-50/60Hz incluído

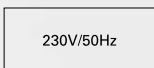

01. Seleccionar versión



LOW OUTPUT

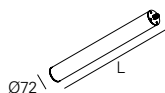

TUP - Difusor transparente

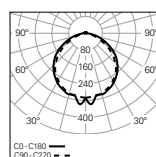

W	lm output	lm/W	Lmm	CÓDIGO*
12	1789	149	620	90489L060▼▲0♣♣
17	2684	158	900	90489L090▼▲0♣♣
21	3578	170	1180	90489L120▼▲0♣♣
26	4473	172	1460	90489L150▼▲0♣♣

TOP - Difusor opalino

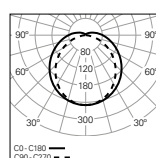

W	lm output	lm/W	Lmm	CÓDIGO*
12	1691	141	620	90488L060▼▲0♣♣
17	2536	149	900	90488L090▼▲0♣♣
21	3382	161	1180	90488L120▼▲0♣♣
26	4227	163	1460	90488L150▼▲0♣♣

*Sustituya los símbolos para completar el código

Fuente de alimentación ▼

HF E

DALI H

Tapas ▲

Polycarbonato¹ 0

Inox² S

Temp. de color ◆

3000K 3

4000K 0

Tunable White³ T

Módulo ♣

SRT/MID 58

END 50

HIGH OUTPUT

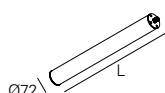

TUP - Difusor transparente

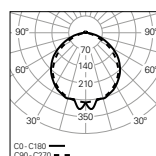

W	lm output	lm/W	Lmm	CÓDIGO*
26	3765	145	620	90487L060▼▲0♣♣
40	5648	141	900	90487L090▼▲0♣♣
51	7531	148	1180	90487L120▼▲0♣♣
63	9413	149	1460	90487L150▼▲0♣♣

TOP - Difusor opalino

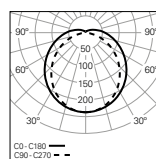

W	lm output	lm/W	Lmm	CÓDIGO*
26	3506	135	620	90486L060▼▲0♣♣
40	5259	131	900	90486L090▼▲0♣♣
51	7011	137	1180	90486L120▼▲0♣♣
63	8764	139	1460	90486L150▼▲0♣♣

MÓDULOS DISPONIBLES

◀ Módulo inicial / intermedio (SRT/MID) ▶ Módulo final (END)

LOW OUTPUT | HIGH OUTPUT





- Para completar el producto es necesario pedir el sistema de fijación por separado.
- Para la versión suspendida es necesario pedir la suspensión y la base de alimentación por separado.
- La luminaria con sensor es 215 mm más larga que la medida estándar.
- El número máximo de luminarias High Output que se pueden conectar en línea es 15. Con sensor el número máximo es 9.
- El número máximo de luminarias Low Output que se pueden conectar en línea es 35. Con sensor el número máximo es 16.

¹ Tapas en policarbonato inyectado transparente. El producto es clase II.

² Tapas en inox. El producto es clase I.

³ Sólo disponible en versiones DALI. Para longitudes L620 y L900 mm, Tunable White solo se aplica a las versiones de final de línea (END).

02. Seleccionar opciones

OPCIONES	Código*
SwitchDIM Tunable White • El SwitchDIM Tubale White permite el control de 20 luminarias como máximo.	926600
Sistema de fijación	
Abrazadera inox A1 D70 (x2) 	915403
Abrazadera inox A2 D70 (x2) 	915405
Abrazadera inox D70 com fecho (x2) 	915404
Suspensión	
S4 L1500 mm (x2)	910200
S4 L3000 mm (x2)	910204
S4 L6000 mm (x2)	910208
Base de techo ¹	
Superficie T24 D95 	978600▲
Empotrar T5 D90 	971300▲
Prensaestopas para versiones HF	
• Para todos los módulos inicial/intermedio (SRT/MID):	
Metálico M16 (x2)	925010
Metálico ventilado M16 (x2)	926710
• Para todos los módulos finales (END):	
Metálico M16 (x1)	925000
Metálico ventilado M16 (x1)	926700
Prensaestopas para versiones DALI	
• Para todos los módulos inicial/intermedio (SRT/MID):	
Metálico M20 (x2)	925011
Metálico ventilado M20 (x2)	926711
• Para todos los módulos finales (END):	
Metálico M20 (x1)	925001
Metálico ventilado M20 (x1)	926701
Sensor	
• Mediante solicitud.	
• Área de detección: 100%. Tiempo de espera: 5 segundos. Limite de luz diurna: desactivado. Para otras programaciones consulte el manual del sensor.	



*Sustituya los símbolos para completar el código

Color ▲
 Blanco W
 Negro B



Detalles del producto

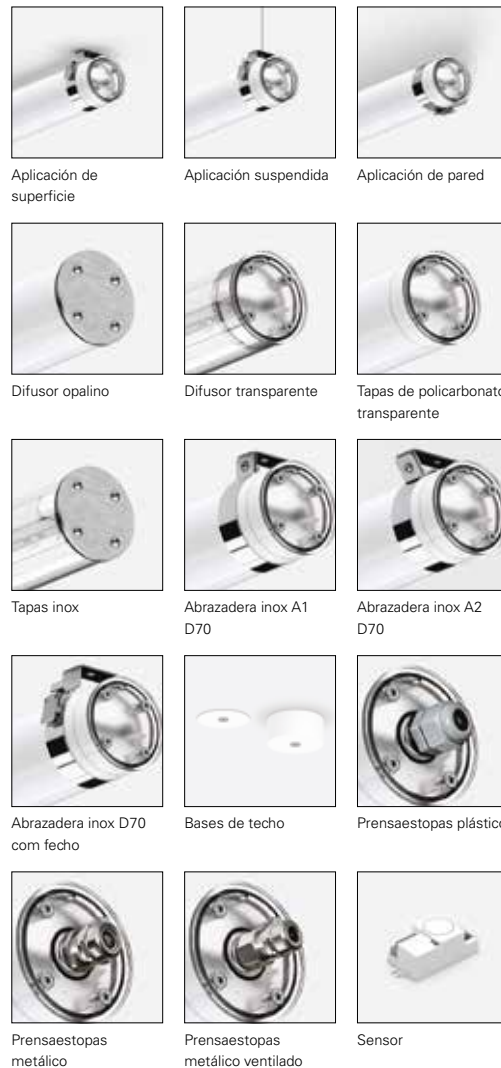

Aplicación de superficie Aplicación suspendida Aplicación de pared

Difusor opalino Difusor transparente Tapas de policarbonato transparente

Tapas inox Abrazadera inox A1 D70 Abrazadera inox A2 D70

Abrazadera inox D70 com fecho Bases de techo Prensaestopas plástico com fecho

Prensaestopas metálico Prensaestopas metálico ventilado Sensor

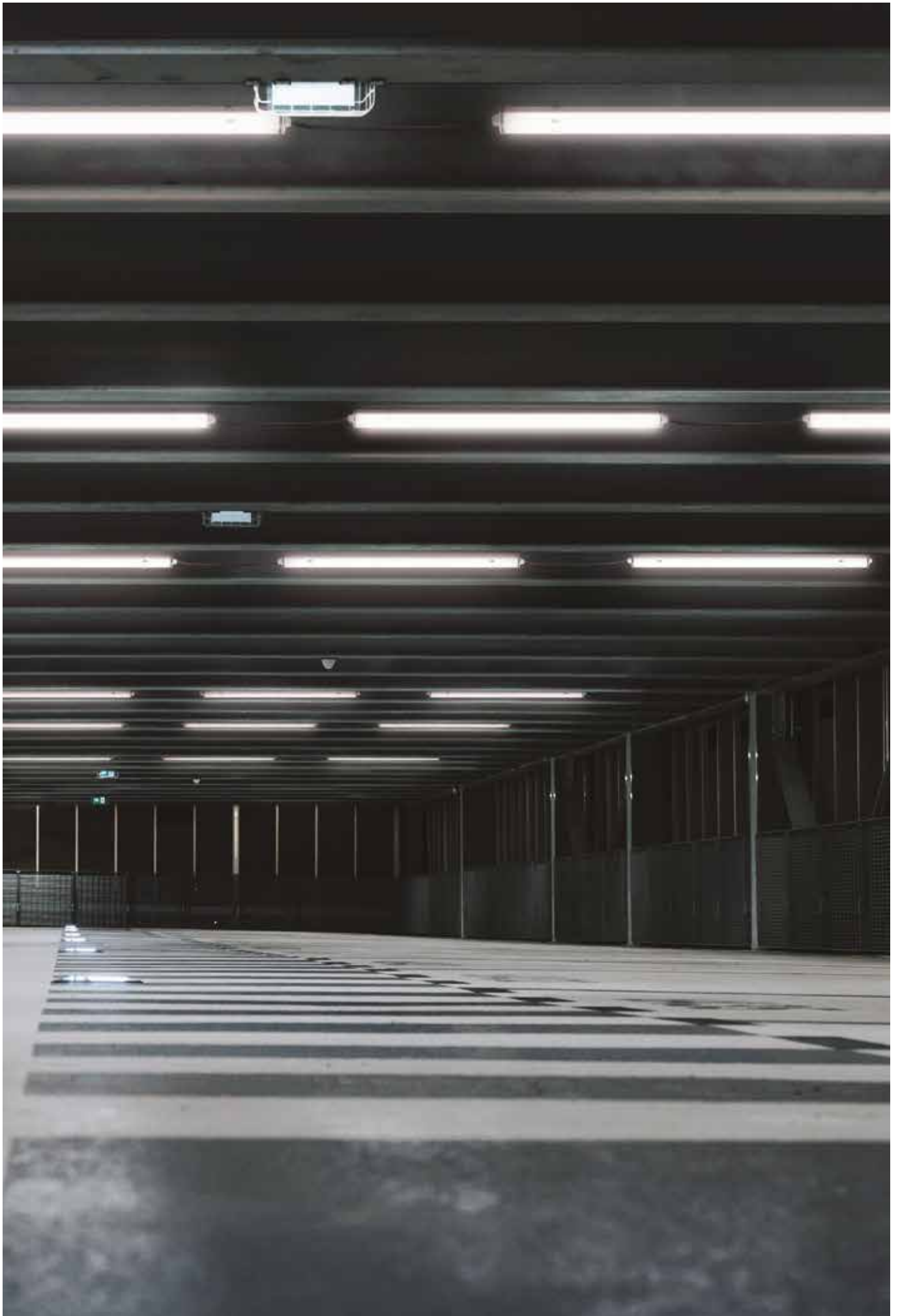

TTP 100



Características del producto

Cuerpo

Tubo de policarbonato

Acabado

Interior pintado con epoxi poliéster blanco mate

Sistema de fijación

Abrazaderas no incluidas

Sistema óptico

TUP - Difusor transparente
TOP - Difusor opalino

Cableado

Cable H07RN-F de 1500 mm con prensaestopas plástico incluido

Fuente de luz

LED, RG0, CRI>80, MacAdam Step ≤3

Vida útil del LED

80.000h @ L90, B10, Ta 25°C

Fuente de alimentación

Driver LED 220-240V-50/60Hz incluido

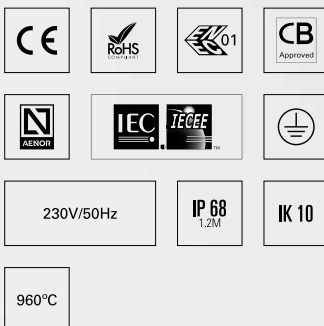

01. Seleccionar versión

TTP 100

Tapas em Aluminio



Tapas em Inox

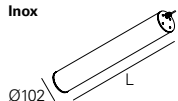

TUP - Difusor transparente

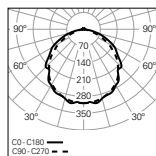

W	lm output	lm/W	Lmm	CÓDIGO*
23	3578	156	660	90481L060▼▲0◆00
33	5367	163	940	90481L090▼▲0◆00
45	7156	159	1220	90481L120▼▲0◆00
76	12566	165	1500	90496L150▼▲0◆00
95	15435	162	1500	90479L150▼▲0◆00

TOP - Difusor opalino

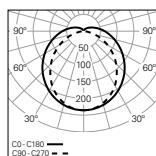

W	lm output	lm/W	Lmm	CÓDIGO*
23	3264	142	660	90480L060▼▲0◆00
33	4895	148	940	90480L090▼▲0◆00
45	6527	145	1220	90480L120▼▲0◆00
76	11388	150	1500	90495L150▼▲0◆00
95	13681	144	1500	90478L150▼▲0◆00

TTP 100

- Para completar el producto es necesario pedir el sistema de fijación por separado.
- Para la versión suspendida es necesario pedir la suspensión y la base de alimentación por separado.
- La luminaria con sensor es 105 mm más larga que la medida estándar.



*Sustituya los símbolos para completar el código

Fuente de alimentación ▼

HF E
DALI H

Tapas ▲

Aluminio 0
Inox S

Emergencia ●

No EM 0
EM 3h (K3) ¹ 3

Temp. de color ◆

3000K 3
4000K 0
Tunable White ² T

¹ Kit de emergencia de 3 horas con autopruebas. Sólo disponible en las versiones HF. Não disponível na versão 95W.

² Sólo disponible en versiones DALI sin kit de emergencia (No EM).

02. Seleccionar opciones

OPCIONES	Código*
SwitchDIM Tunable White	926600
<ul style="list-style-type: none"> • El SwitchDIM Tubale White permite el control de 20 luminarias como máximo. • Para la versión de L1500 mm, sólo permite controlar 10 luminarias. 	
Sistema de fijación	
Abrazadera inox A1 D100 (x2)	 915503
Abrazadera inox A2 D100 (x2)	 915505
Abrazadera inox D100 con fecho (x2)	 915504
Suspensión	
S4 L1500 mm (x2)	910200
Base de techo ¹	
Superficie T24 D95	 978600♣
Empotrar T5 D90	 971300♣
Prensaestopas para versiones HF	
Metálico M16 (x1)	925000
Metálico ventilado M16 (x1)	926700
Prensaestopas para versiones DALI	
Metálico M20 (x1)	925001
Metálico ventilado M20 (x1)	926701
Sensor	
<ul style="list-style-type: none"> • Mediante solicitud. • Área de detección: 100%. Tiempo de espera: 5 segundos. Límite de luz diurna: desactivado. Para otras programaciones consulte el manual del sensor. 	
Sensor e kit de Emergencia (3 Horas)	
<ul style="list-style-type: none"> • Mediante solicitud. 	



*Sustituya los símbolos para completar el código

Color ♣
 Blanco W
 Negro B



Detalles del producto

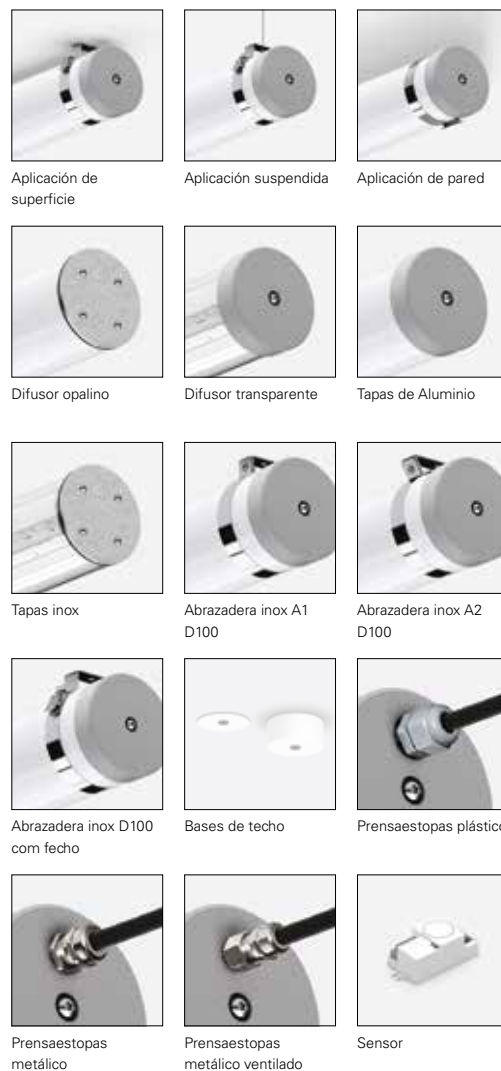

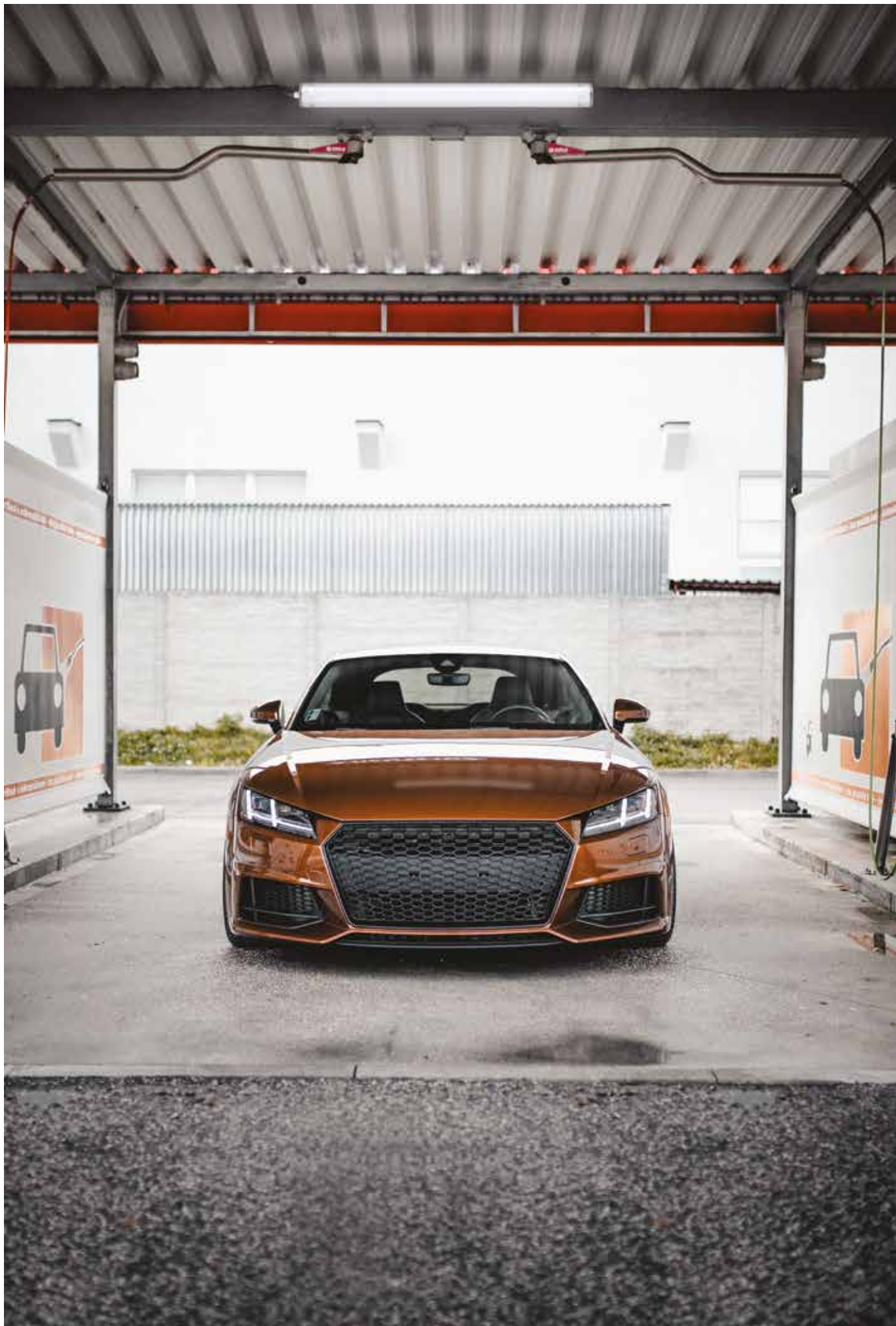

TTP 100 Line



Características del producto

Cuerpo

Tubo de policarbonato

Acabado

Interior pintado con epoxi poliéster blanco mate

Sistema de fijación

Abrazaderas no incluidas

Sistema óptico

TUP - Difusor transparente
TOP - Difusor opalino

Cableado

Prensaestopas plástico e Cableado interna de linha continua incluída
Cable H07RN-F de 1500 mm no incluido

Fuente de luz

LED, RG0, CRI>80, MacAdam Step ≤ 3

Vida útil del LED

80.000h @ L90, B10, Ta 25°C

Fuente de alimentación

Driver LED 220-240V-50/60Hz incluido



230V/50Hz



IP 68
I.Z.M.

IK 10

960°C

01. Seleccionar versión

TTP 100 Line

Tapas em Aluminio



Tapas em Inox

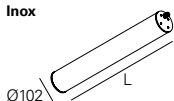

TUP - Difusor transparente

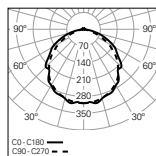

W	lm output	lm/W	Lmm	CÓDIGO*
23	3578	156	660	90493L060▼▲0♣♣
33	5367	163	940	90493L090▼▲0♣♣
45	7156	159	1220	90493L120▼▲0♣♣
76	12556	165	1500	90514L150▼▲0♣♣
95	15435	162	1500	90491L150▼▲0♣♣

TOP - Difusor opalino

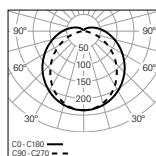

W	lm output	lm/W	Lmm	CÓDIGO*
23	3264	142	660	90492L060▼▲0♣♣
33	4895	148	940	90492L090▼▲0♣♣
45	6527	145	1220	90492L120▼▲0♣♣
76	11388	150	1500	90513L150▼▲0♣♣
95	13681	144	1500	90490L150▼▲0♣♣



*Sustituya los símbolos para completar el código

Fuente de alimentación ▼

HF	E
DALI	H

Tapas ▲

Aluminio	0
Inox	S

Temp. de color ◆

3000K	3
4000K	0
Tunable White ¹	T

Módulo ♣

SRT/MID	58
END	50

MÓDULOS DISPONIBLES

Módulo inicial / intermedio (SRT/MID)

 Módulo final (END)

TTP 100 Line

- Para completar el producto es necesario pedir el sistema de fijación por separado.
- Para la versión suspendida es necesario pedir la suspensión y la base de alimentación por separado.
- La luminaria con sensor es 170 mm más larga que la medida estándar.
- El número máximo de luminarias que se pueden conectar en línea es 31. Con sensor el número máximo es 8.
- El número máximo de luminarias que se pueden conectar en línea para la versión (L1500 mm - 95W) es 15. Con sensor el número máximo es 4.

¹ Sólo disponible en versiones DALI. Para longitudes L660 y L940 mm, Tunable White solo se aplica a las versiones de final de línea (END).

02. Seleccionar opciones

OPCIONES	Código*
SwitchDIM Tunable White	926600
<ul style="list-style-type: none"> • El SwitchDIM Tubale White permite el control de 20 luminarias como máximo. • Para la versión de L1500 mm, sólo permite controlar 10 luminarias. 	
Sistema de fijación	
Abrazadera inox A1 D100 (x2)	915503
Abrazadera inox A2 D100 (x2)	915505
Abrazadera inox D100 com fecho (x2)	915504
Suspensión	
S4 L1500 mm (x2)	910200
S4 L3000 mm (x2)	910204
S4 L6000 mm (x2)	910208
Base de techo ¹	
Superficie T24 D95	978600
Empotrar T5 D90	971300
Prensaestopas para versiones HF	
<ul style="list-style-type: none"> • Para todos los módulos inicial/intermedio (SRT/MID): 	
Metálico M16 (x2)	925010
Metálico ventilado M16 (x2)	926710
<ul style="list-style-type: none"> • Para todos los módulos finales (END): 	
Metálico M16 (x1)	925000
Metálico ventilado M16 (x1)	926700
Prensaestopas para versiones DALI	
<ul style="list-style-type: none"> • Para todos los módulos inicial/intermedio (SRT/MID): 	
Metálico M20 (x2)	925011
Metálico ventilado M20 (x2)	926711
<ul style="list-style-type: none"> • Para todos los módulos finales (END): 	
Metálico M20 (x1)	925001
Metálico ventilado M20 (x1)	926701



*Sustituya los símbolos para completar el código

Color

<input type="checkbox"/> Blanco	W
<input checked="" type="checkbox"/> Negro	B



Detalles del producto



Aplicación de superficie



Aplicación suspendida



Aplicación de pared



Difusor opalino



Difusor transparente



Tapas de Aluminio



Tapas inox



Abrazadera inox A1 D100



Abrazadera inox A2 D100



Abrazadera inox D100 com fecho



Bases de techo



Prensaestopas plástico



Prensaestopas metálico



Prensaestopas metálico ventilado



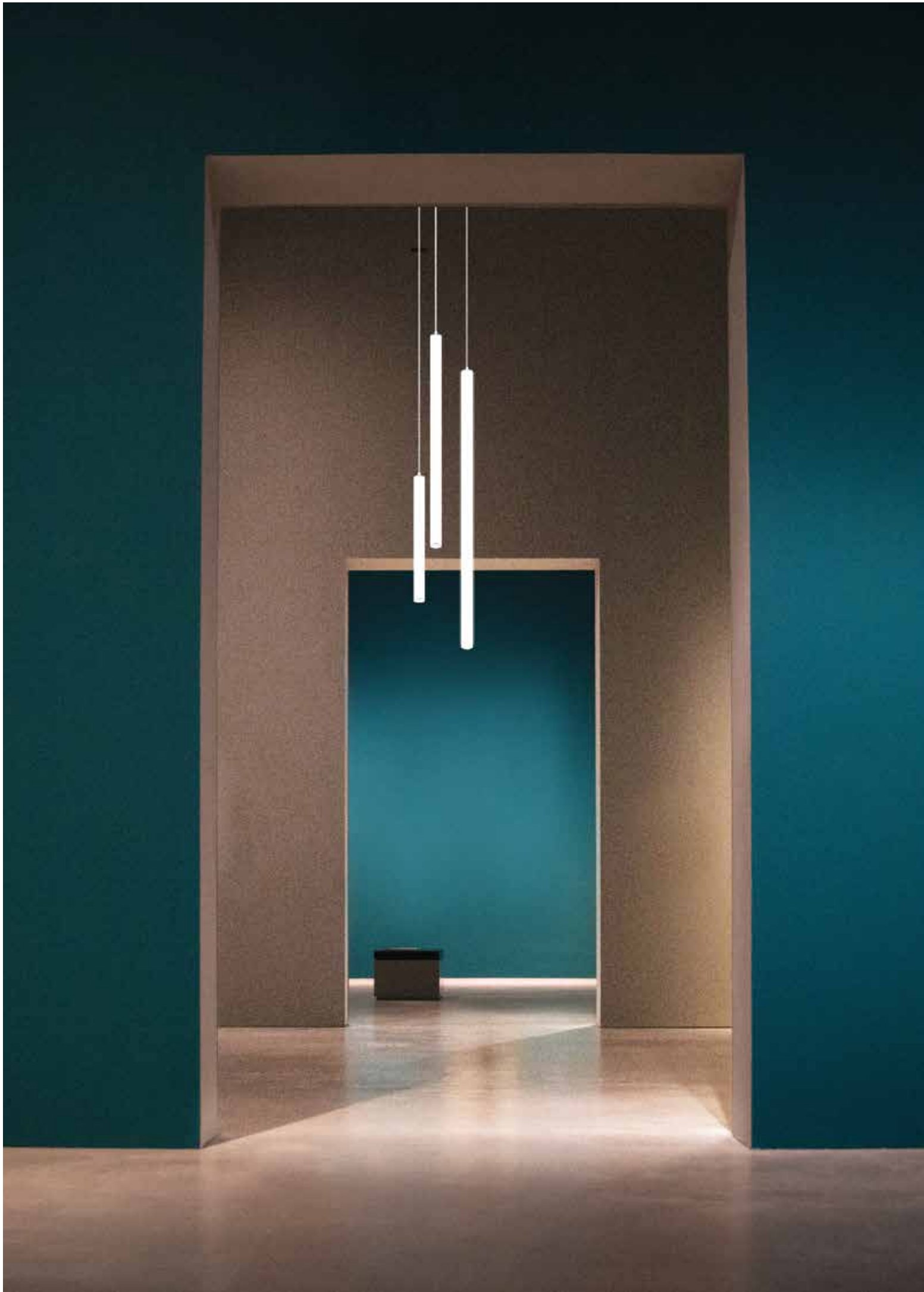

Luminarias
tubulares

TTP 50 360



TTP 50 360 HRZ
734



TTP 50 360 VRT
738



TTP 50 360 HRZ



Características del producto

Cuerpo

Tubo de policarbonato

Acabado

Tapas em Aluminio revestidos
a epoxi poliester

Sistema óptico

TOP - Difusor opalino

Fuente de luz

LED, RG0, CRI>80, MacAdam Step ≤3

Vida útil del LED

70.000h @ L80, B10, Ta 25°C

Fuente de alimentación

No incluido



01. Seleccionar versión

TTP 50 360 HRZ

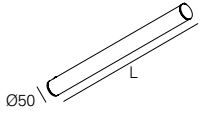

TOP - Difusor opalino

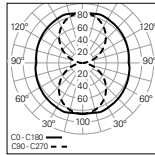

W	lm output	lm/W	Lmm	CÓDIGO*
10	912	91	572	90677L0600♣0♦00
18	1685	94	972	90677L0900♣0♦00
23	2275	99	1272	90677L1200♣0♦00
29	2916	101	1572	90677L1500♣0♦00



*Sustituya los símbolos para completar el código

Color	♣
□ Blanco	W
■ Gris	G
■ Negro	B

Temp. de color	♦
3000K	3
4000K	0

TTP 50 360 HRZ

- Para completar el producto es necesario pedir el cable y la base de alimentación por separado.

02. Seleccionar base de alimentación

Empotrar - T31 D90

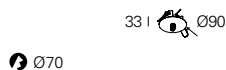

HF

L572, L972, L1272, L1572 **CÓDIGO***
972750♣

DALI

L572, L972, L1272, L1572 **CÓDIGO***
972752♣

Superficie - T36 L350W50

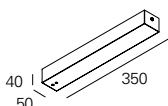

HF

L572, L972, L1272, L1572 **CÓDIGO***
972770♣

DALI

L572, L972, L1272, L1572 **CÓDIGO***
972772♣

BASE DE TECHO

- Driver incluido en la base de techo.

03. Seleccionar opciones

OPCIONES Código

Suspensión

- Para caixa empotrar T31 D90:

S4 L1500 mm (x2) **910200**
S4 L3000 mm (x2) **910204**
S4 L6000 mm (x2) **910208**

- Para caixa saliente T36 L350W50:

S13 L1500 mm (x2) **913200**
S13 L3000 mm (x2) **913201**
S13 L6000 mm (x2) **913202**

Cable de alimentación transparente

L1500 mm - 2 x 0,75 mm² **942800**
L3000 mm - 2 x 0,75 mm² **942801**
L6000 mm - 2 x 0,75 mm² **942802**



*Sustituya los símbolos para completar el código

Color ♣
 Blanco W
 Negro B



Detalles del producto



Suspensión

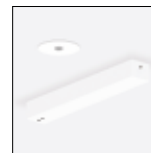

Bases de techo



TTP 50 360 VRT



Características del producto

Cuerpo

Tubo de policarbonato

**Acabado**

Tapas em Aluminio revestidos
a epoxi poliester

**Sistema óptico**

Policarbonato

**Fuente de luz**

LED, RG0, CRI>80, MacAdam Step ≤3

Vida útil del LED

70.000h @ L80, B10, Ta 25°C

Fuente de alimentación

No incluido

01. Seleccionar versión



TTP 50 360 VRT

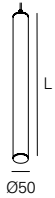

TOP - Difusor opalino

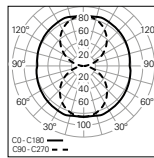

W	lm output	lm/W	Lmm	CÓDIGO*
10	912	91	570	90555L0600▲0♦00
18	1685	94	970	90555L0900▲0♦00
23	2275	99	1270	90555L1200▲0♦00
29	2916	101	1570	90555L1500▲0♦00
34	3370	99	1870	90555L1800▲0♦00
37	3744	101	2070	90555L2000▲0♦00

*Sustituya los símbolos para completar el código

Color	▲
□ Blanco	W
■ Gris	G
■ Negro	B

Temp. de color	♦
3000K	3
4000K	0

TTP 50 360 VRT

- Para completar el producto es necesario pedir el cable y la base de alimentación por separado.

02. Seleccionar base de alimentación

Empotrar - T31 D90

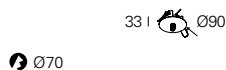

Ø70

HF

	CÓDIGO*
L572, L972, L1272, L1572	972750♣
L1872, L2072	972751♣

DALI

	CÓDIGO*
L572, L972, L1272, L1572	972752♣
L1872, L207	972753♣

Superficie - T32 D80

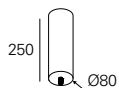

HF

	CÓDIGO*
L572, L972, L1272, L1572	972760♣
L1872, L2072	972761♣

DALI

	CÓDIGO*
L572, L972, L1272, L1572	972762♣
L1872, L2072	972763♣

BASE DETECHO

- Driver incluido en la base de techo.

03. Seleccionar opciones

OPCIONES Código

Cable de alimentación transparente

L1500 mm - 2 x 0,75 mm ²	942800
L3000 mm - 2 x 0,75 mm ²	942801
L6000 mm - 2 x 0,75 mm ²	942802

Proyectos a medida

- Mediante solicitud.



*Sustituya los símbolos para completar el código

Color	♣
<input type="checkbox"/> Blanco	W
<input type="checkbox"/> Negro	B



Detalles del producto



Bases de techo

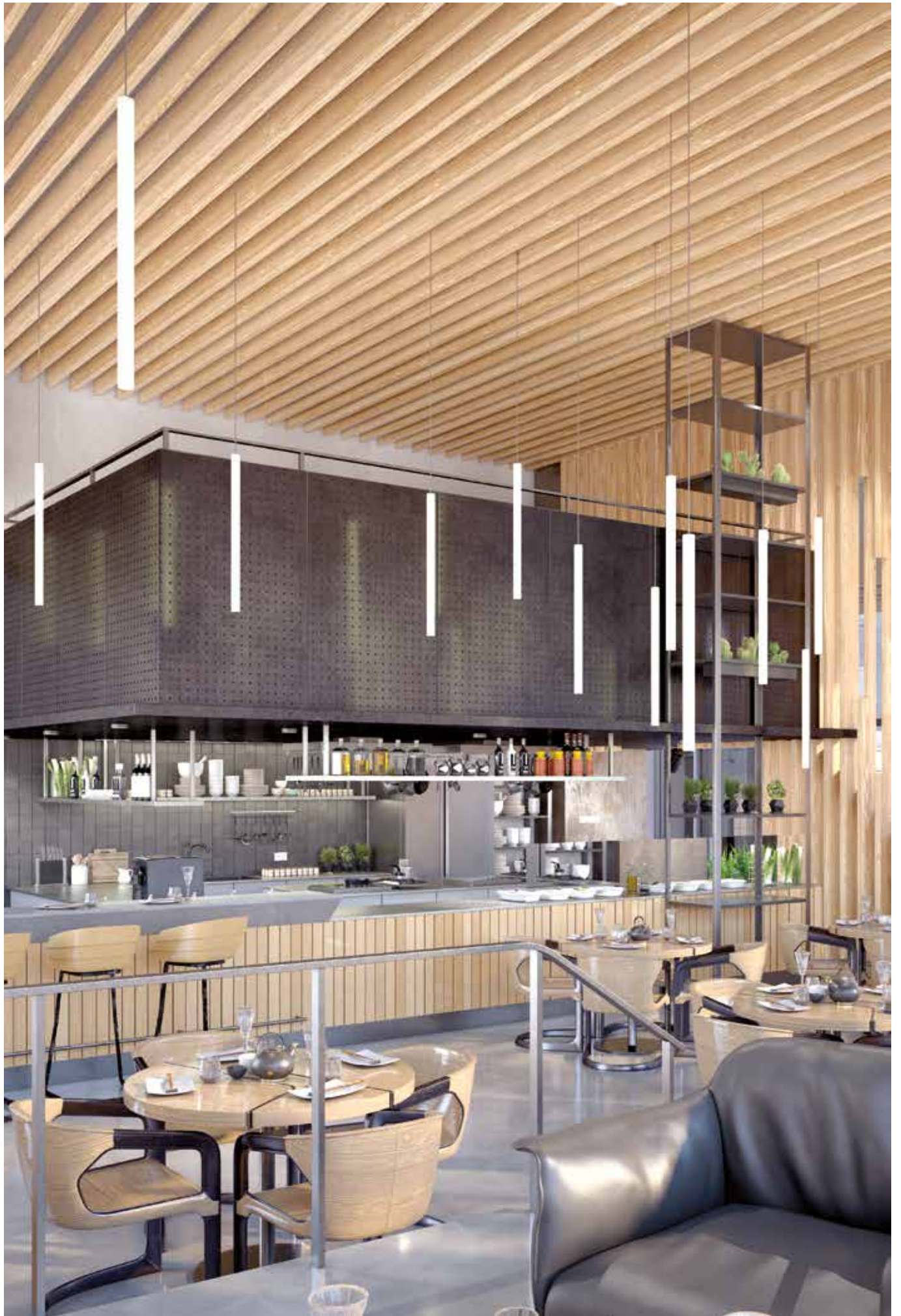



Luminarias
tubulares

TTP 70 COLOUR



TTP 70 Colour
746



Defina su color

LUMINARIAS
TUBULARES

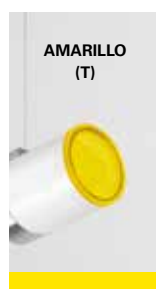
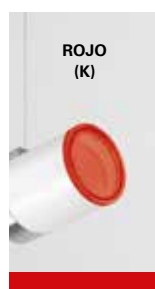
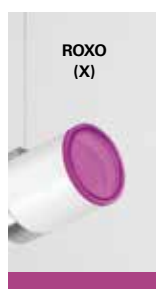
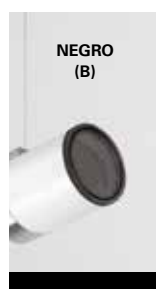
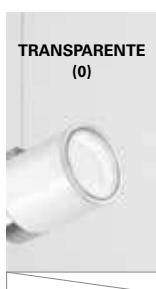

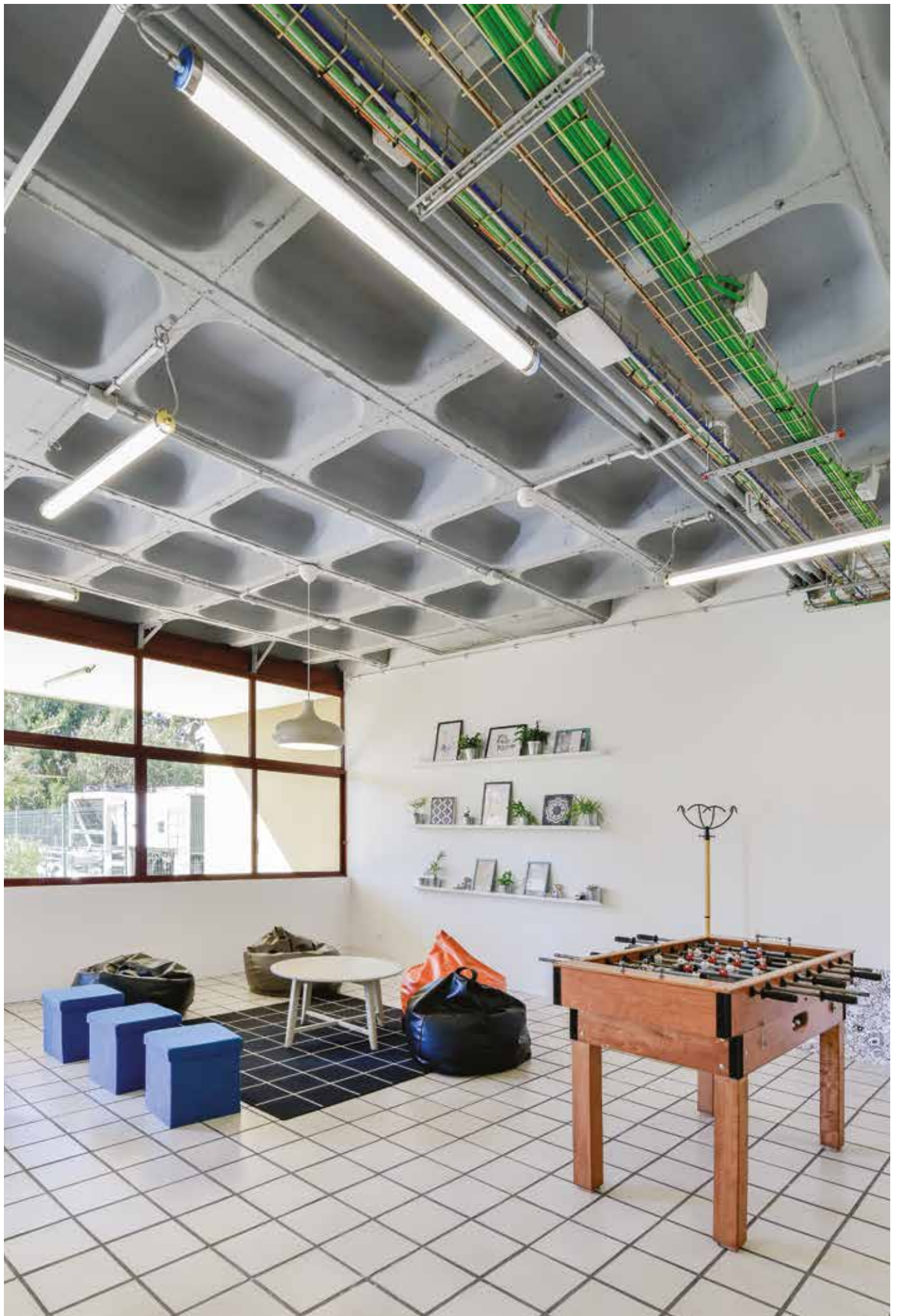

TTP 70 Colour

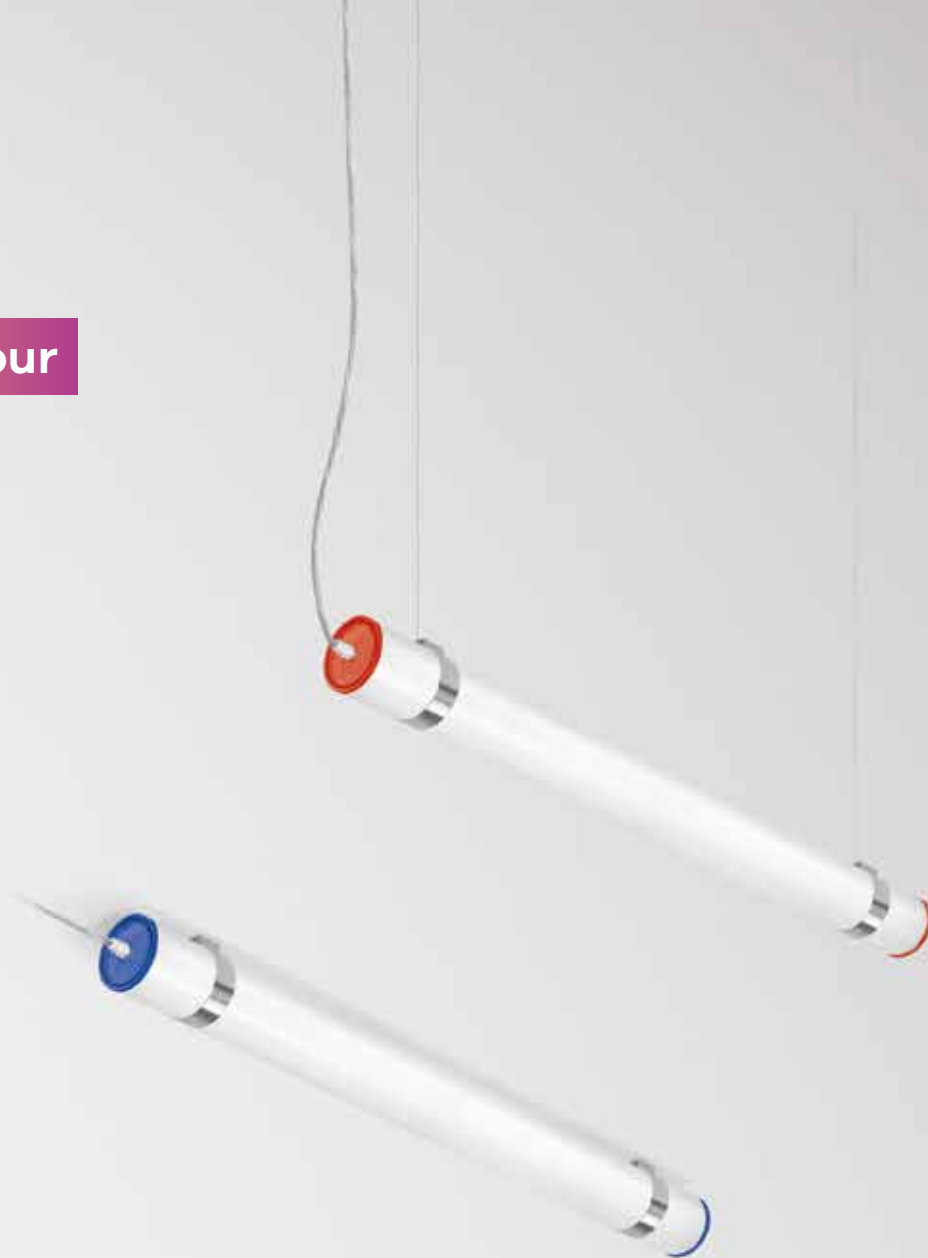

Características del producto

Cuerpo

Tubo de policarbonato e Tapas injetados em policarbonato



Acabado

Interior pintado con epoxi poliéster blanco mate

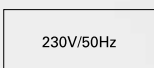

Sistema de fijación

Abrazaderas no incluidas



Sistema óptico

TOP - Difusor opalino



Cableado

Cable transparente de 1500mm con prensaestopas plástico incluido

Fuente de luz

LED, RG0, CRI>80, MacAdam Step ≤ 3

Vida útil del LED

80.000h @ L90, B10, Ta 25°C

Fuente de alimentación

Driver LED 220-240V-50/60Hz incluido

01. Seleccionar versión

TTP 70 Colour

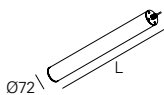

TOP - Difusor opalino

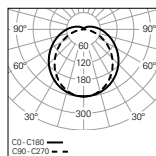

W	lm output	lm/W	Lmm	CÓDIGO*
12	1691	141	620	90551L060▼▲◆0◆00
17	2536	149	900	90551L090▼▲◆0◆00
21	3382	161	1180	90551L120▼▲◆0◆00
26	4227	163	1460	90551L150▼▲◆0◆00

TTP 70 Colour

- Para completar el producto es necesario pedir el sistema de fijación por separado.
- Para la versión suspendida es necesario pedir la suspensión y la base de alimentación por separado.



*Sustituya los símbolos para completar el código

Fuente de alimentación ▼

HF E

DALI¹ H

Color² ▲

☐ Transparente 0

■ Negro B

■ Roxo X

■ Rojo K

■ Naranja Y

■ Amarillo T

■ Verde V

■ Azul U

Emergencia ●

No EM 0

EM 3h (K3)³ 3

Temp. de color ◆

3000K 3

4000K 0

02. Seleccionar opciones

OPCIONES Código

Sistema de fijación

Abrazadera inox A1 D70 (x2) 915403

Suspensión

S4 L3000 mm (x2) 910204

S4 L6000 mm (x2) 910208

Cable de alimentación transparente

L3000 mm - 3 x 0,75 mm² 940401

L3000 mm - 5 x 0,75 mm² 940501

L6000 mm - 3 x 0,75 mm² 940402

L6000 mm - 5 x 0,75 mm² 940507

Base circular

Superficie T24 D95 978600▲

Empotrar T5 D90 971300▲

IP44

- Mediante solicitud.

¹ En las versiones DALI, la luminaria está equipada con un prensaestopas metálico y un cable transparente de 5 x 1,5 mm².

² Color de las tapas.

³ Kit de emergencia de 3 horas con autopruebas. Sólo disponible en las versiones HF.

LUMINARIAS ESTANCAS



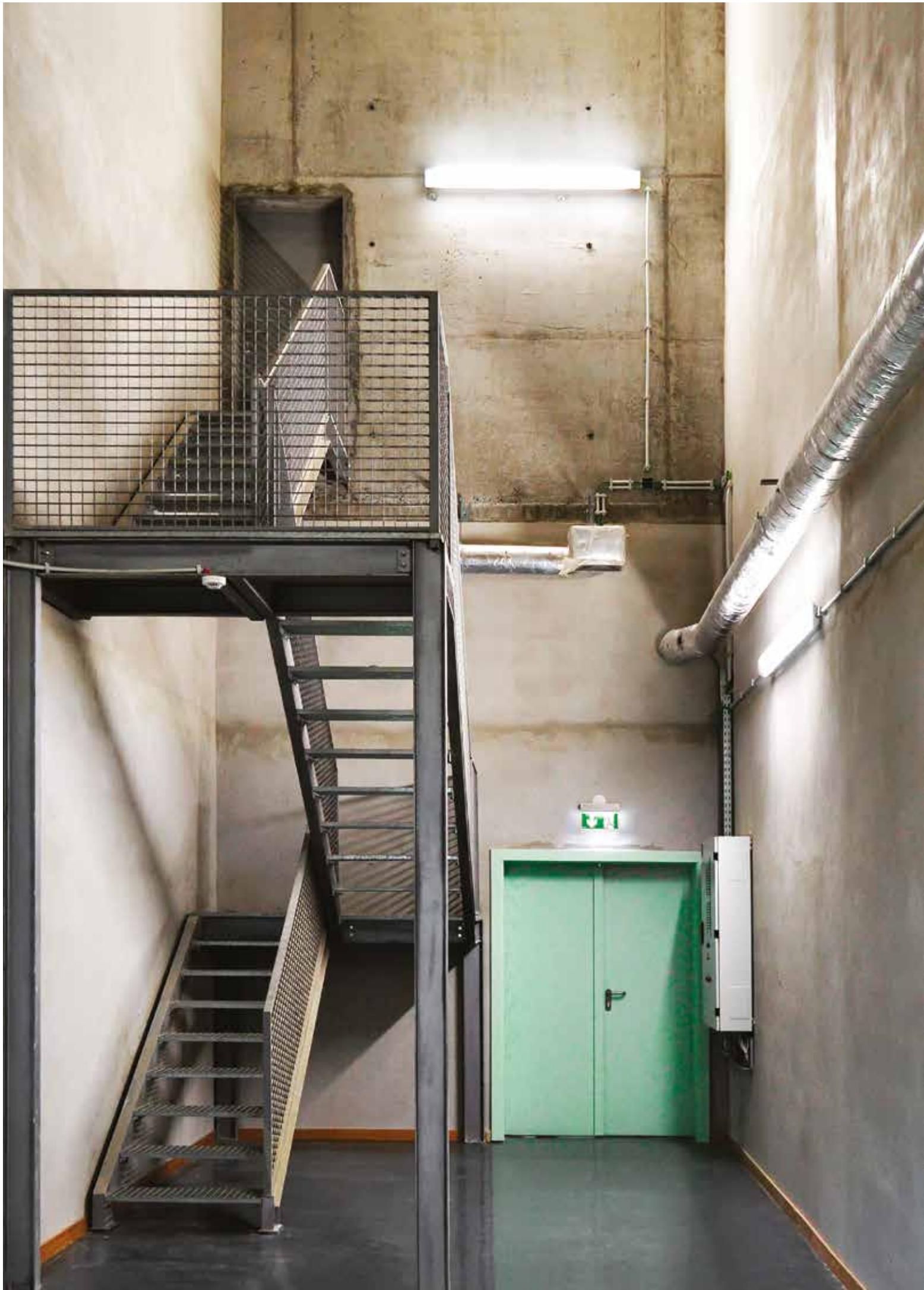

Luminarias
estancas

DORIS



DORIS
752



DORIS



Características del producto

Cuerpo

Policarbonato y junta de poliuretano

Acabado

Interior pintado con epoxi poliéster blanco mate

Sistema de fijación

Clips y soportes de fijación de acero inoxidable

Sistema óptico

PC0 - Difusor de policarbonato opal

Fuente de luz

LED 4000K, RG1, CRI>80, MacAdam Step ≤3

Vida útil del LED

50.000h @ L90, B10, Ta 25°C

Fuente de alimentación

Driver LED 220-240V-50/60Hz incluido

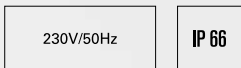

01. Seleccionar versión

DORIS

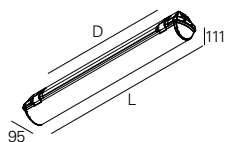

PC0 - Difusor de policarbonato opal

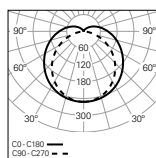

W	lm output	lm/W	Lmm	Dmm	CÓDIGO*
14	1960	140	662	350	90617L060♥0●000
27	3870	143	1272	700	90617L120♥0●000
38	5570	147	1272	700	90617L122♥0●000
33	4820	146	1572	940	90617L150♥0●000
45	6890	153	1572	940	90617L152♥0●000



*Sustituya los símbolos para completar el código

Fuente de alimentación ▼

HF E

DALI H

Emergencia ●

No EM 0

EM 3h (K3) ¹ 3

Detalles del producto



Clips de inox



Soportes de fijación de acero inoxidable para montaje en techo



Soporte de fijación en inox para montaje suspendida



Cuerpo preparado para Loop In Loop Out



Difusor de policarbonato opal

¹ Preparado para teledmando.

AMBIENTES INDUSTRIALES Y DEPORTIVOS





**Ambientes industriales
y deportivos**

CAB



CAB
758



CAB



Características del productos

Cuerpo

Chapa de acero

Aro

Aluminio

Acabado

Pintado en epoxi-poliéster blanco mate

Cableado

Precableado con cable H05VV-F
de 1000 mm

Sistema óptico

Narrow - Haz estrecho
Medium - Haz medio
Wide - Haz ancho

Fuente de luz

LED 4000K, RG1, CRI>80, MacAdam Step ≤ 3

Vida útil del LED

80.000h @ L80, B10, Ta 25°C

Fuente de alimentación

Driver LED 220-240V-50/60Hz incluido



230V/50Hz



IK 09

960°C

01. Seleccionar versión



CAB

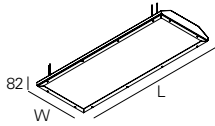

NARROW - Haz estrecho

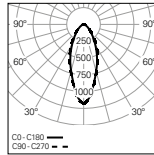

W	lm output	lm/W	LxWmm	CÓDIGO*
68	11206	165	676x365	90849L063▼VV●000
136	22411	165	1250x365	90849L123▼VV●000
182	29882	164	1250x470	90849L124▼VV●000

MEDIUM - Haz medio

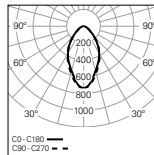

W	lm output	lm/W	LxWmm	CÓDIGO*
68	11206	165	676x365	90850L063▼VV●000
136	22411	165	1250x365	90850L123▼VV●000
182	29882	164	1250x470	90850L124▼VV●000

WIDE - Haz ancho

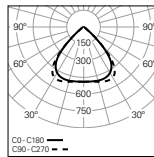

W	lm output	lm/W	LxWmm	CÓDIGO*
68	11327	167	676x365	90851L063▼VV●000
136	22655	167	1250x365	90851L123▼VV●000
182	30206	166	1250x470	90851L124▼VV●000

*Sustituya los símbolos para completar el código

Fuente de alimentación	▼
HF	E
DALI	H



Emergencia	●
No EM	0
EM 3h (K3) ¹	3

CAB

- Para completar el producto es necesario pedir el sistema de fijación por separado.

¹ Preparado para telemando.

02. Seleccionar opciones

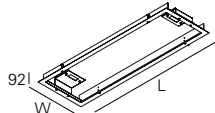
OPCIONES	Código
Kit de conectores	
Kit de conectores IP68 3 polos	966300
Kit de conectores IP68 5 polos	966400
Kit para versión de superficie	
Fijaciones y tornillos incluidos (x2)	925701
Kit de rotación	
Fijaciones y tornillos incluidos (x2)	925700
Suspensión	
Kit Rabo de cerdo (x4)	911200
Kit Ojal (x4)	911202
Kit para Catenaria (x2)	911203
Kit de empotramiento	
676x365 mm	925702
1250x365 mm	925703
1250x470 mm	925704
<ul style="list-style-type: none">  725x412  1300x412  1300x518 	
Cable de seguridad en acero	
L1500 mm	955000
Sensor de luminosidad y presencia	
• Mediante solicitud.	
Versión de baja potencia	
• Mediante solicitud.	



Detalles del producto



Kit para versión de superficie



Kit de rotación



Suspensiones



Kit de empotramiento



LUMINARIAS ANTIVANDÁLICAS





Luminarias
antivandálicas

ZLP



ZLP /E
766



ZLP
768



ZLP /C
772



ZLP /W
774



ZLP /E



Características del producto

Cuerpo

Chapa de acero

Acabado

Pintado en epoxi-poliéster blanco mate

Sistema de fijación

Varilla roscada M5 no incluido

Sistema óptico

DOZ - Difusor opalino

Fuente de luz

LED, RG1, CRI>80, MacAdam Step ≤ 3

Vida útil del LED

72.000h @ L80, B10, Ta 25°C

Fuente de alimentación

Driver LED 220-240V-50/60Hz incluido

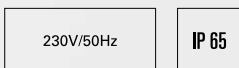

01. Seleccionar versión

ZLP / E

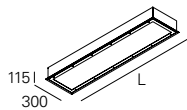

DOZ - Difusor opalino

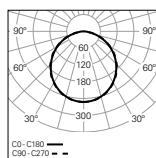

W	lm output	lm/W	Lmm	■	CÓDIGO*
38	4561	120	1225	1200x275	906J2222J♥4♣00
47	5701	121	1525	1500x275	906J2272J♥4♣00



*Sustituya los símbolos para completar el código

Fuente de alimentación	▼
HF	F
DALI	E

Versión	♣
No EM	0
EM 3h (K3) ¹	3
Sensor	4
Night Light	N

Temp. de color	♦
3000K	3
4000K	0

02. Seleccionar opciones

OPCIONES Código

Punta especial antivandálica 926000



Detalles del producto



Punta antivandálica



Tornillo de seguridad antivandálico



Desarrollado para soportar impactos físicos extremos de hasta 170 julios (IK17)

¹ Preparado para telemando.



Características del producto

Cuerpo

Chapa de acero



Acabado

Pintado en epoxi-poliéster blanco mate

230V/50Hz

Sistema de fijación

Varilla roscada M5 no incluido



Sistema óptico

DOZ - Difusor opalino

Fuente de luz

LED, RG1, CRI>80, MacAdam Step ≤ 3



Vida útil del LED

72.000h @ L80, B10, Ta 25°C

Fuente de alimentación

Driver LED 220-240V-50/60Hz incluido

01. Seleccionar versión

ZLP

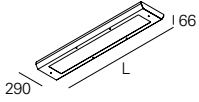

DOZ - Difusor opalino

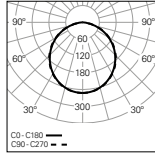

W	lm output	lm/W	Lmm	CÓDIGO*
38	4561	120	1350	906H2222J♥4♣00
47	5701	121	1650	906H2272J♥4♣00



*Sustituya los símbolos para completar el código

Fuente de alimentación	▼
HF	F
DALI	E

Versión	♣
No EM	0
EM 3h (K3) ¹	3
Sensor	4
Night Light	N

Temp. de color	♦
3000K	3
4000K	0

02. Seleccionar opciones

OPCIONES	Código
Punta especial antivandálica	926000



Detalles del producto



Punta antivandálica



Tornillo de seguridad antivandálico



Desarrollado para soportar impactos físicos extremos de hasta 170 julios (IK17)

¹ Preparado para telemando.



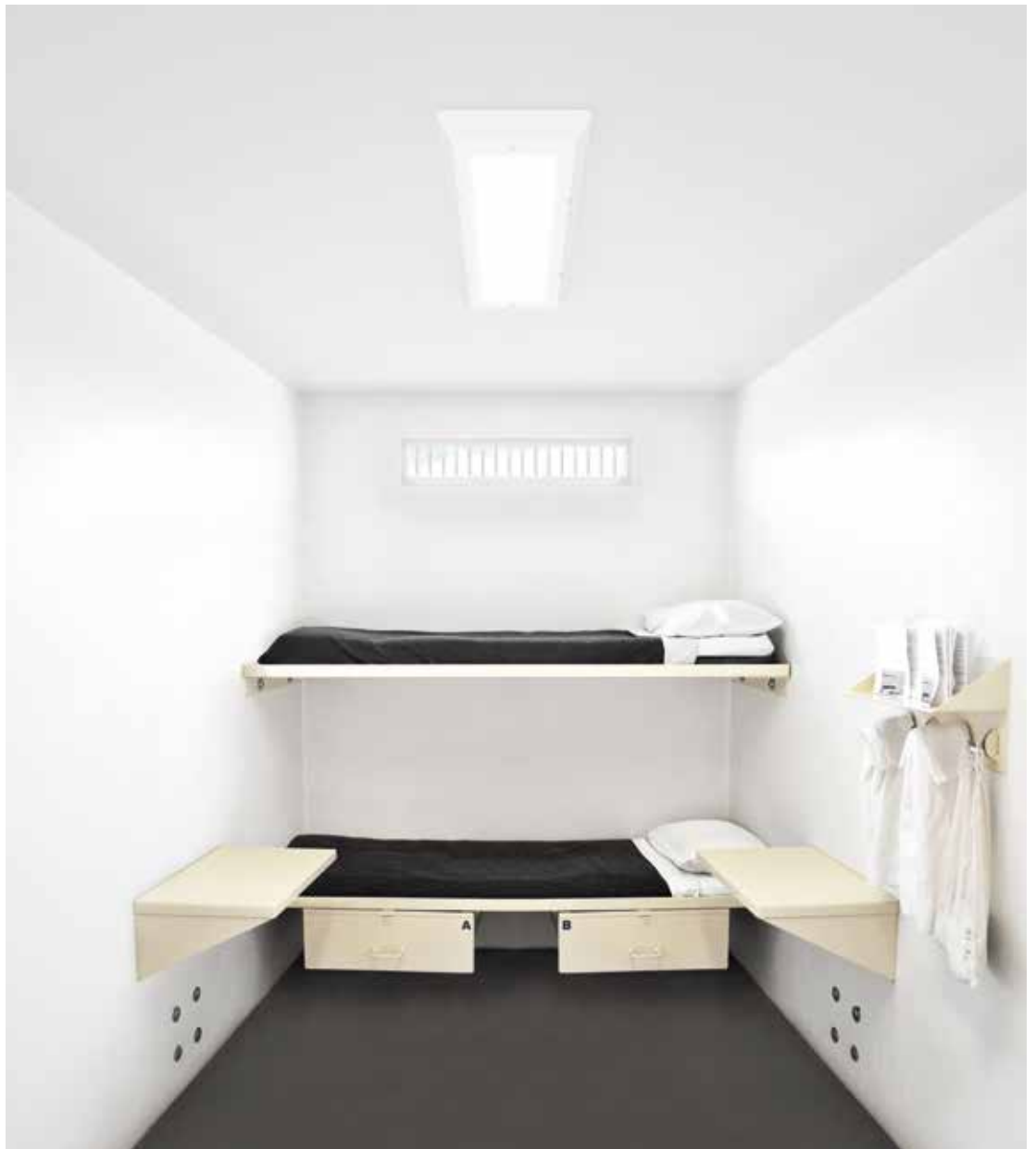

ZLP /C

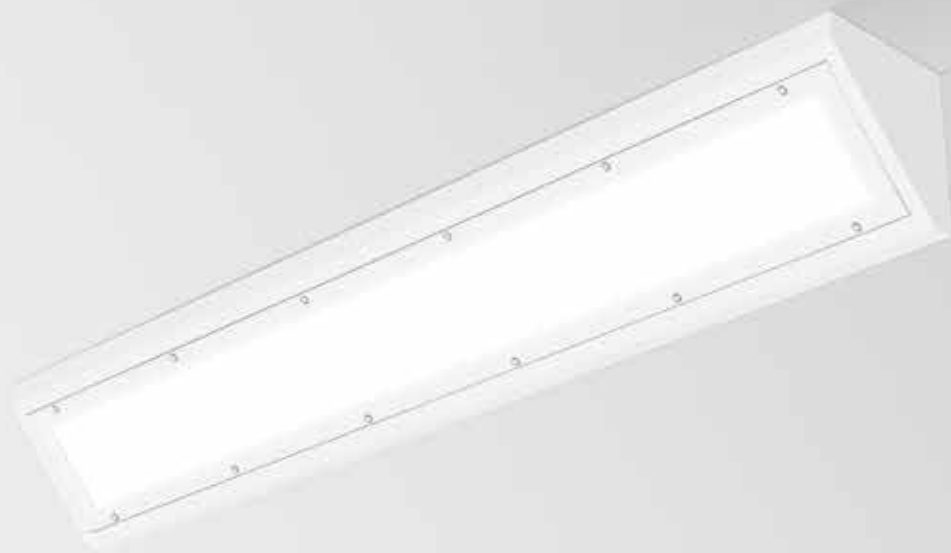

Características del producto

Cuerpo

Chapa de acero



Acabado

Pintado en epoxi-poliéster blanco mate

230V/50Hz

Sistema de fijación

Varilla roscada M5 no incluido



Sistema óptico

DOZ - Difusor opalino

Fuente de luz

LED, RG1, CRI>80, MacAdam Step ≤ 3



Vida útil del LED

72.000h @ L80, B10, Ta 25°C

Fuente de alimentación

Driver LED 220-240V-50/60Hz incluido

01. Seleccionar versión

ZLP / C

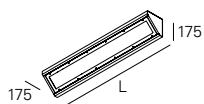

DOZ - Difusor opalino

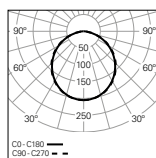

W	lm output	lm/W	Lmm	CÓDIGO*
38	3662	96	1215	906I2222J♥4♣♦00
47	4577	97	1515	906I2272J♥4♣♦00



*Sustituya los símbolos para completar el código

Fuente de alimentación	
HF	F
DALI	E

Versión	
No EM	0
EM 3h (K3) ¹	3
Sensor	4
Night Light	N

Temp. de color	
3000K	3
4000K	0

02. Seleccionar opciones

OPCIONES	Código
Punta especial antivandálica	926000



Detalles del producto



Punta antivandálica



Tornillo de seguridad antivandálico



Desarrollado para soportar impactos físicos extremos de hasta 170 julios (IK17)

¹ Preparado para telemando.

ZLP /W



Características del producto

Cuerpo

Chapa de acero



Acabado

Pintado en epoxi-poliéster blanco mate

230V/50Hz

Sistema de fijación

Varilla roscada M5 no incluido



Sistema óptico

DOZ - Difusor opalino

Fuente de luz

LED, RG1, CRI>80, MacAdam Step ≤3



Vida útil del LED

80.000h @ L90, B10, Ta 25°C

Fuente de alimentación

Driver LED 220-240V-50/60Hz incluido

01. Seleccionar versión



ZLP /W

*Sustituya los símbolos para completar el código



DOZ - Difusor opalino

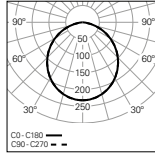

W	lm output	lm/W	Lmm	CÓDIGO*
4	307	77	200	90832L020♥W0♦00
6	614	102	200	90831L020♥W0♦00
6	613	102	300	90832L030♥W0♦00
11	1226	111	300	90831L030♥W0♦00

Fuente de alimentación	
HF	E
DALI	H

Temp. de color	
3000K	3
4000K	0

02. Seleccionar opciones



Detalles del producto

OPCIONES	Código
Punta especial antivandálica	926000



Punta antivandálica



Tornillo de seguridad antivandálico



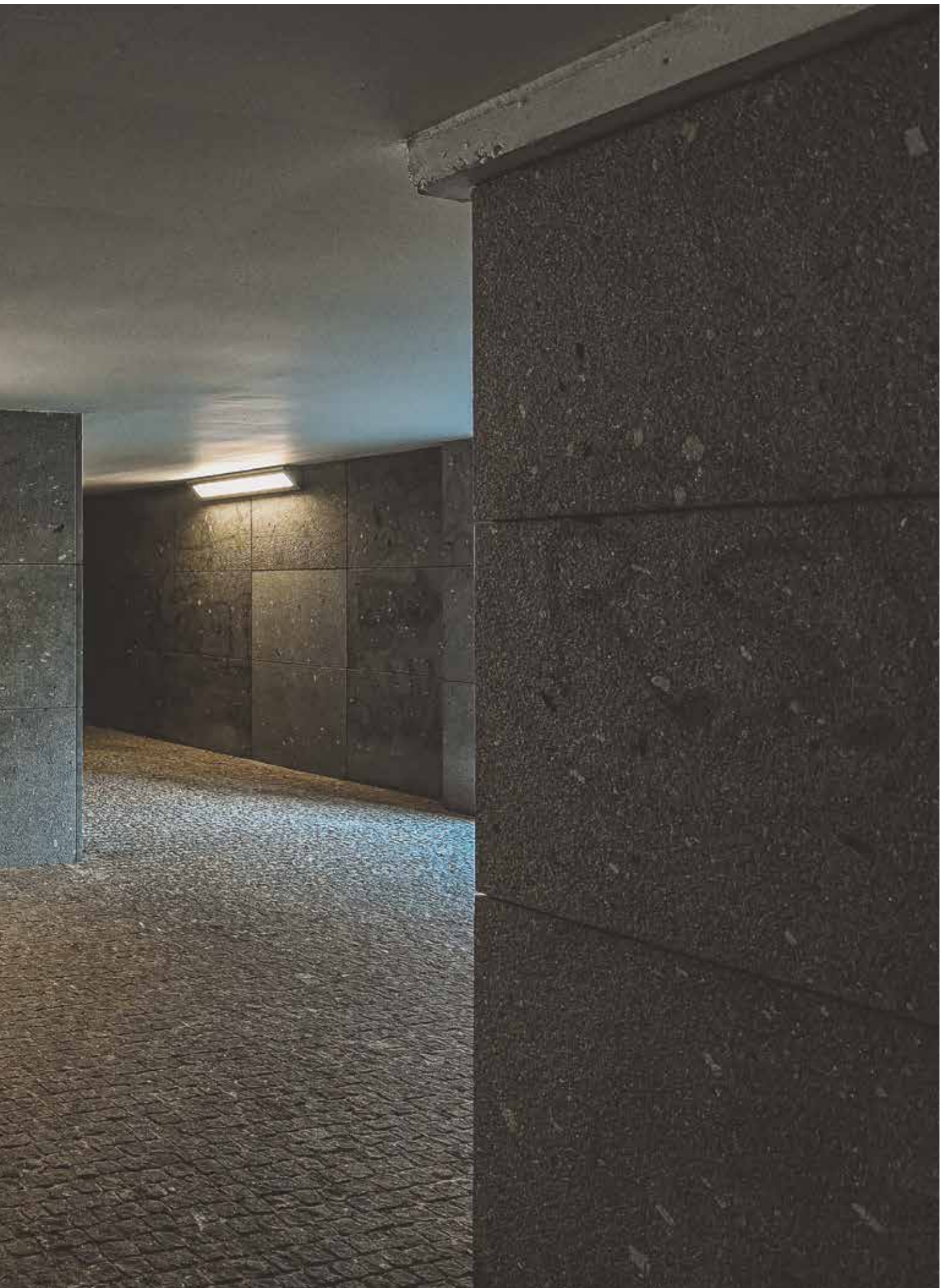

REGLETAS & CARRIL DE ALUMBRADO





**Regletas & carril
de alumbrado**

PAS



PAS
782



PAS Line
784



REGLETAS & CARRIL
DE ALUMBRADO

PAS



Características del producto

Cuerpo

Perfil de aluminio extruido



Acabado

Pintado en epoxi-poliéster

230V/50Hz

Sistema óptico

Lente



IP 20

Fuente de luz

LED 4000K, RG1, CRI>80, MacAdam Step ≤3

Vida útil del LED

80.000h @ L80, B10, Ta 25°C

650°C

Fuente de alimentación

Driver LED 220-240V-50/60Hz incluido

01. Seleccionar versión

PAS

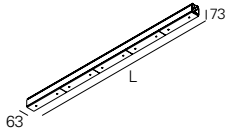

Óptica simétrica | Ángulo de apertura 90°

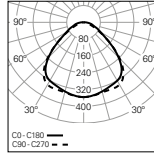

W	lm output	lm/W	Lmm	CÓDIGO*
50	8050	161	1436	90770L005♥♣♠000
59	9338	158	1436	90771L005♥♣♠000
100	16100	161	2871	90770L010♥♣♠000
118	18676	158	2871	90771L010♥♣♠000

Óptica asimétrica

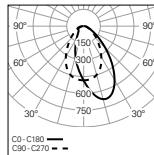

W	lm output	lm/W	Lmm	CÓDIGO*
50	7963	159	1436	90772L005♥♣♠000
59	9237	157	1436	90773L005♥♣♠000
100	15925	159	2871	90772L010♥♣♠000
118	18473	157	2871	90773L010♥♣♠000



*Sustituya los símbolos para completar el código

Fuente de alimentación ▼
 HF E
 DALI H

Color ▲
 Blanco W
 Gris G

Emergencia ●
 No EM 0
 EM 3h (K3) ¹ 3

PAS

• En la longitud de L2871 mm, sólo mitad de la luminaria es equipada con kit emergencia.

02. Seleccionar opciones



Detalles del producto

OPCIONES Código

Cable de alimentación

• Mediante solicitud.

Suspensión

Soporte de fijación para varilla roscada (x2)	910102
Soporte de fijación + gancho rabo de cerdo (x2)	910101
Soporte de fijación + cable suspensión (x2)	910103
Soporte de fijación + gancho para suspensión (x2)	910100



Suspensión

¹ Preparado para telemando.

REGLETAS & CARRIL
DE ALUMBRADO

PAS Line



Características del producto

Cuerpo

Perfil de aluminio extruido



Acabado

Pintado en epoxi-poliéster

230V/50Hz

Sistema óptico

Lente



Fuente de luz

LED 4000K, RG1, CRI>80, MacAdam Step ≤3

Vida útil del LED

80.000h @ L80, B10, Ta 25°C



Fuente de alimentación

Driver LED 220-240V-50/60Hz incluido

01. Seleccionar versión



PAS Line

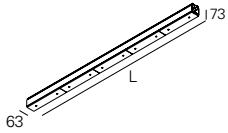

Óptica simétrica | Ángulo de apertura 90°

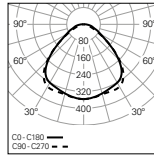

W	lm output	lm/W	Lmm	CÓDIGO*
50	8050	161	1435	90774L005▼▲●000
59	9338	158	1435	90775L005▼▲●000
100	16100	161	2870	90774L010▼▲●000
118	18676	158	2870	90775L010▼▲●000

Óptica asimétrica

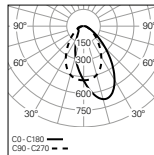

W	lm output	lm/W	Lmm	CÓDIGO*
50	7963	159	1435	90776L005▼▲●000
59	9237	157	1435	90777L005▼▲●000
100	15925	159	2870	90776L010▼▲●000
118	18473	157	2870	90777L010▼▲●000

*Sustituya los símbolos para completar el código

Fuente de alimentación ▼

HF	E
DALI	H
HF trifásico	R
DALI trifásico	S

Color ▲

<input type="checkbox"/> Blanco	W
<input type="checkbox"/> Gris	G

Emergencia ●

No EM	0
EM 3h (K3) ¹	3

PAS Line

- Para la versión suspendida, es necesario pedir suspensiones por separado.
- Para completar una línea, es necesario un Start Kit, cableado de línea continua y kit de unión. Por favor solicítelo por separado.
- En la longitud de L2870 mm, sólo mitad de la luminaria es equipada con kit emergencia.
- Las dimensiones no incluyen el star kit. Incremente 1 mm a la longitud para completar la línea.
- La longitud máxima de línea con un único punto de alimentación es de 30000 mm.

¹ Preparado para telemando.

02. Seleccionar opciones

OPCIONES	Código*
Start kit - Tapas inicio/final	
Blanco	921501
Gris	921500
• Dos tapas finales incluidas.	
Cableado línea continua	
3 x 1,5 mm ²	945660
5 x 1,5 mm ²	945760
7 x 1,5 mm ²	946060
9 x 1,5 mm ²	948660
11 x 1,5 mm ²	948860
Kit de unión	
	930800
• Kit de unión en acero cincado.	
Cable de alimentación	
• Mediante solicitud.	
Suspensión	
Soporte de fijación para varilla roscada (x2)	910102
Soporte de fijación + gancho rabo de cerdo (x2)	910101
Soporte de fijación + cable suspensión (x2)	910103
Soporte de fijación + gancho para suspensión (x2)	910100
Módulo ciego	
L1500 mm	992600♣
L3000 mm	992601♣
Proyectos a medida	
• Mediante solicitud.	



*Sustituya los símbolos para completar el código

Color ♣

Blanco W

Gris G



Detalles del producto



Suspensión



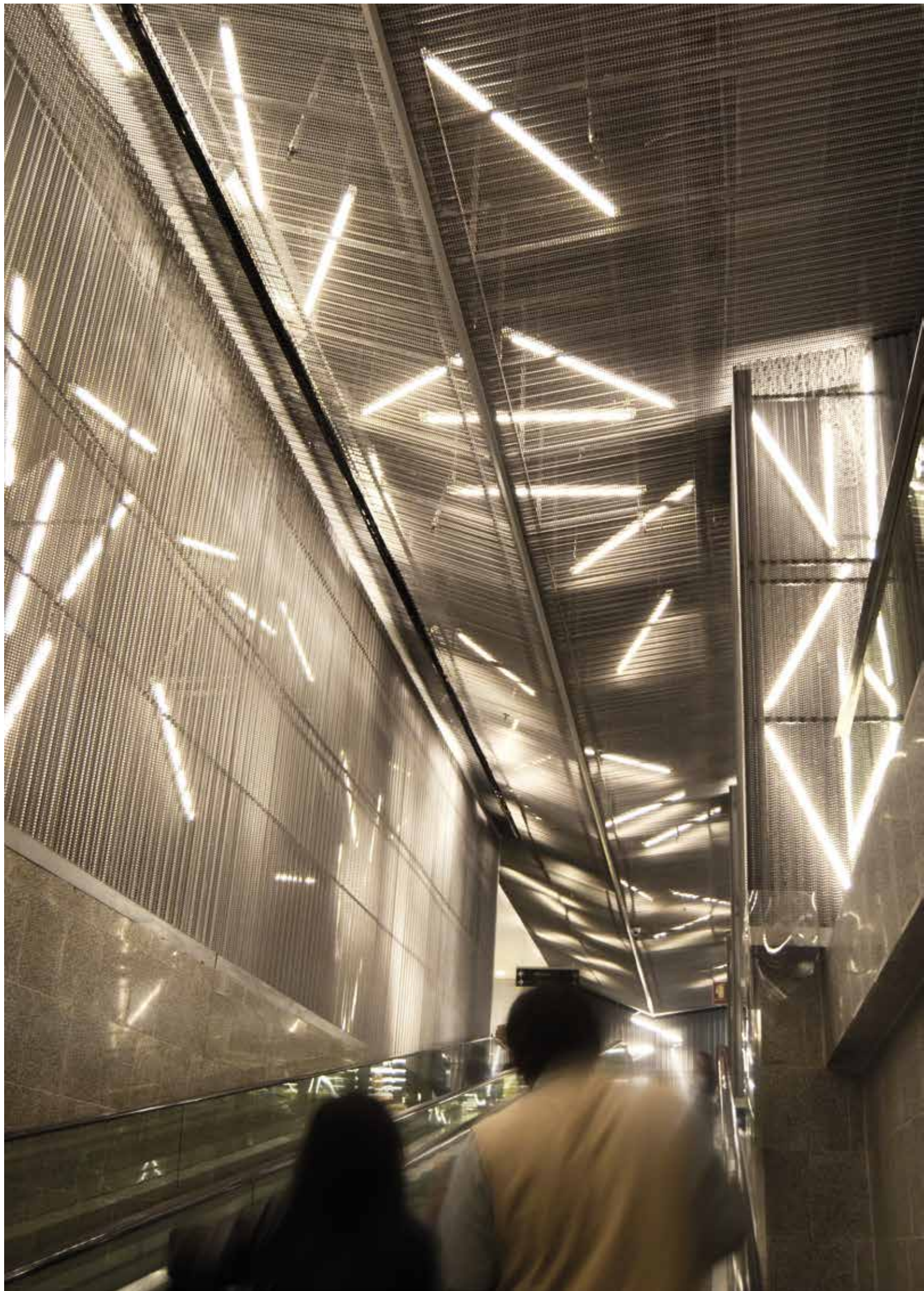

Regletas & carril
de alumbrado

TRN



TRN
790





Características del producto

Cuerpo

Chapa de acero



Acabado

Pintado en epoxi-poliéster blanco mate

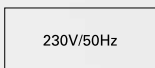

Sistema óptico

DAZ - Difusor opalino



Fuente de luz

LED, RG1, CRI>80, MacAdam Step ≤3

Vida útil del LED

80.000h @ L90, B10, Ta 25°C



Fuente de alimentación

Driver LED 220-240V-50/60Hz incluido

01. Seleccionar versión

TRN

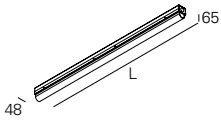

DAZ - Difusor opalino

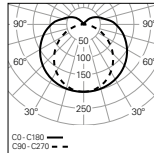

W	lm output	lm/W	Lmm	CÓDIGO*
12	1747	146	590	90834L060▼W0♣♣
23	3494	146	1150	90834L120▼W0♣♣
29	4368	151	1430	90834L150▼W0♣♣



*Sustituya los símbolos para completar el código

Fuente de alimentación	▼
HF	E
DALI	H

Emergencia	●
No EM	0
EM 3h (K3) ¹	3

Temp. de color	◆
3000K	3
4000K	0

Conector	♣
Sin conector	00
M3M ²	M3
M5M ³	M5
M3MFC ⁴	C3
M5MFC ⁵	C5



Detalles del producto



Conector



LED

¹ Preparado para telemando.

² Conector Mini Wieland 3 polos GST15i3 macho.

³ Conector Mini Wieland 5 polos GST15i5 macho.

⁴ Conector Mini Wieland 3 polos GST15i3 macho + L1000 mm de cable con Mini Wieland 3 polos hembra.

⁵ Conector Mini Wieland 5 polos GST15i5 DIM macho + L1000 mm de cable con Mini Wieland 5 polos GST15i5 DIM hembra.

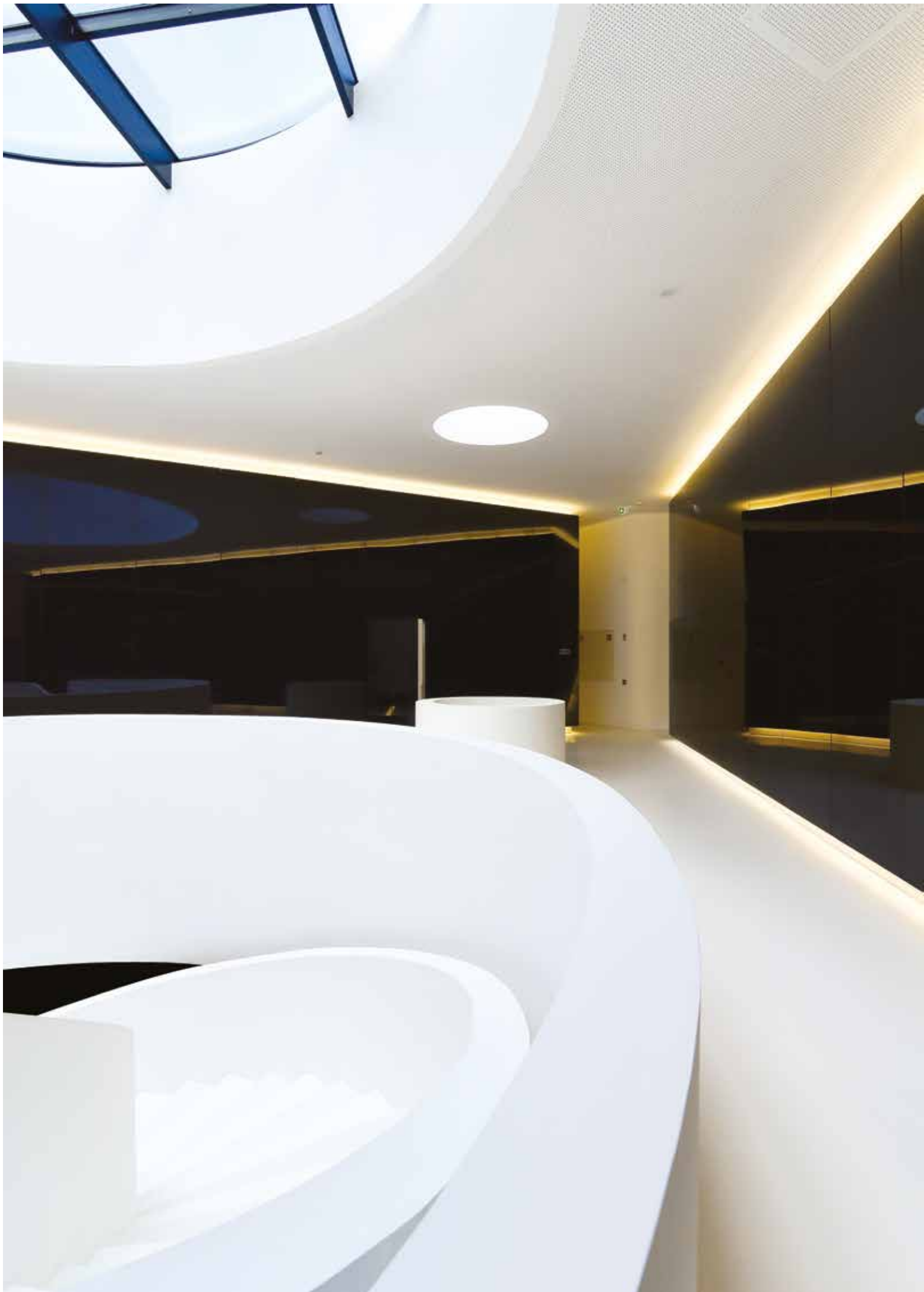

**Regletas & carril
de alumbrado**

AVL



AVL
794





Características del producto

Cuerpo

Chapa de acero



Acabado

Pintado en epoxi-poliéster blanco mate

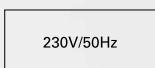

Sistema óptico

DPT - Difusor transparente



Fuente de luz

LED, RG1, CRI>80, MacAdam Step ≤3

Vida útil del LED

80.000h @ L80, B10, Ta 25°C



Fuente de alimentación

Driver LED 220-240V-50/60Hz incluido

01. Seleccionar versión

AVL

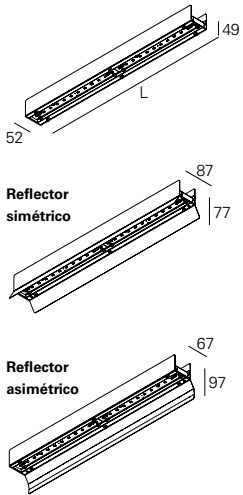

DPT - Difusor transparente

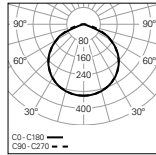

W	lm output	lm/W	Lmm	CÓDIGO*
13	1786	137	561	90826L060♥VV0♦00
18	2678	149	841	90826L090♥VV0♦00
24	3571	149	1121	90826L120♥VV♦♦00
29	4464	154	1401	90826L150♥VV♦♦00



*Sustituya los símbolos para completar el código

Fuente de alimentación	▼
HF	E
DALI	H

Emergencia	●
No EM	0
EM 3h (K3) ¹	3

Temp. de color	◆
3000K	3
4000K	0

02. Seleccionar opciones

OPCIONES	Código
Reflector simétrico	
L561 mm	980600
L841 mm	980601
L1121 mm	980602
L1401 mm	980603
Reflector asimétrico	
L561 mm	980500
L841 mm	980501
L1121 mm	980502
L1401 mm	980503
Cableado línea continua	
3 x 1,5 mm ²	945650
5 x 1,5 mm ²	945750
7 x 1,5 mm ²	946050
9 x 1,5 mm ²	948650
Kit de fijación	
• Fijación por tornillos M4x8 DIN7985.	926100



Detalles del producto



Reflector simétrico

Reflector asimétrico

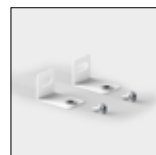

Kit de fijación

¹ Preparado para telemando.

REGLETAS & CARRIL DE ALUMBRADO



Composición de los elementos estructurales

1. Alimentación terminal

- 1.1 Izquierdo
- 1.2 Derecho

2. Carril

3. Alimentación en L

- 3.1 Interior
- 3.2 Exterior

4. Alimentación en T

- 4.1 Exterior Derecho
- 4.2 Exterior Izquierdo
- 4.3 Interior Izquierdo
- 4.4 Interior Derecho

5. Alimentación Central

6. Alimentación en X

7. Conector

- 7.1 Conector recto
- 7.2 Conector ajustable
- 7.3 Conector flexible

8. Tapa

Diagrama de cableado para línea continua

A

1-fases, 3-circuitos 230 V AC,
16 A, 3.7 kVA



N-conductor I = máx. 16 A

B

3-fases, 3-circuitos 230/400 V AC,
16 A, 3 x 3.7 kVA



L1+L2+L3: I = máx. 16 A

C

3-fases, 3-circuitos 230/400 V AC,
16 A, 11.1 kVA

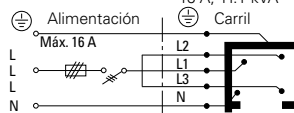

N-conductor I = máx. 16 A

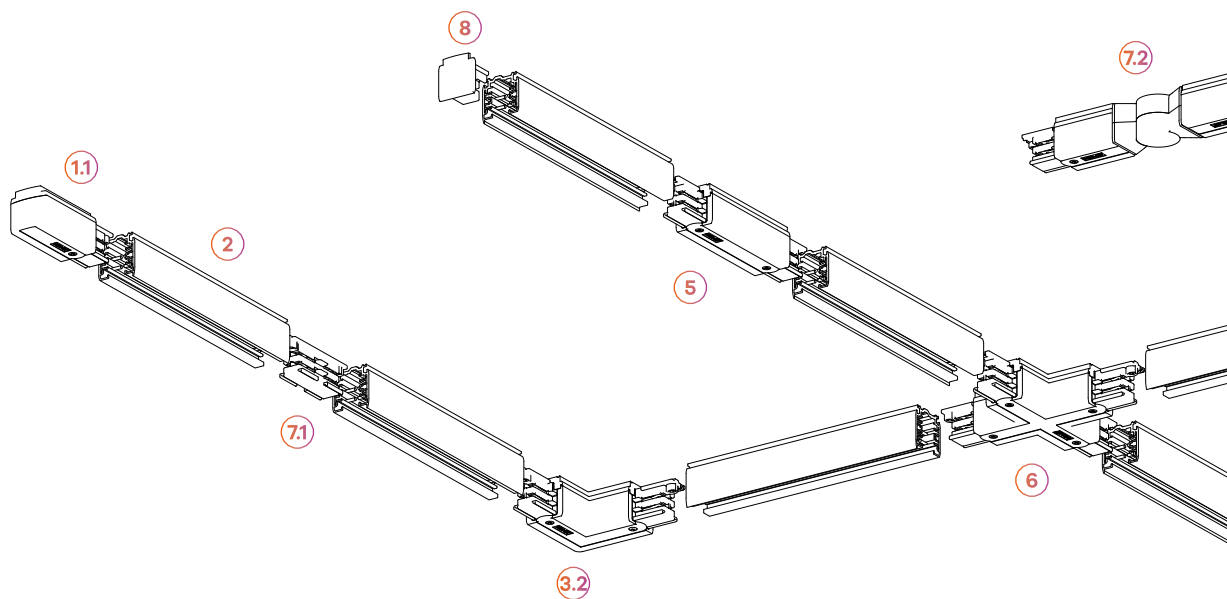

Cómo montar una línea

(Vista desde arriba)

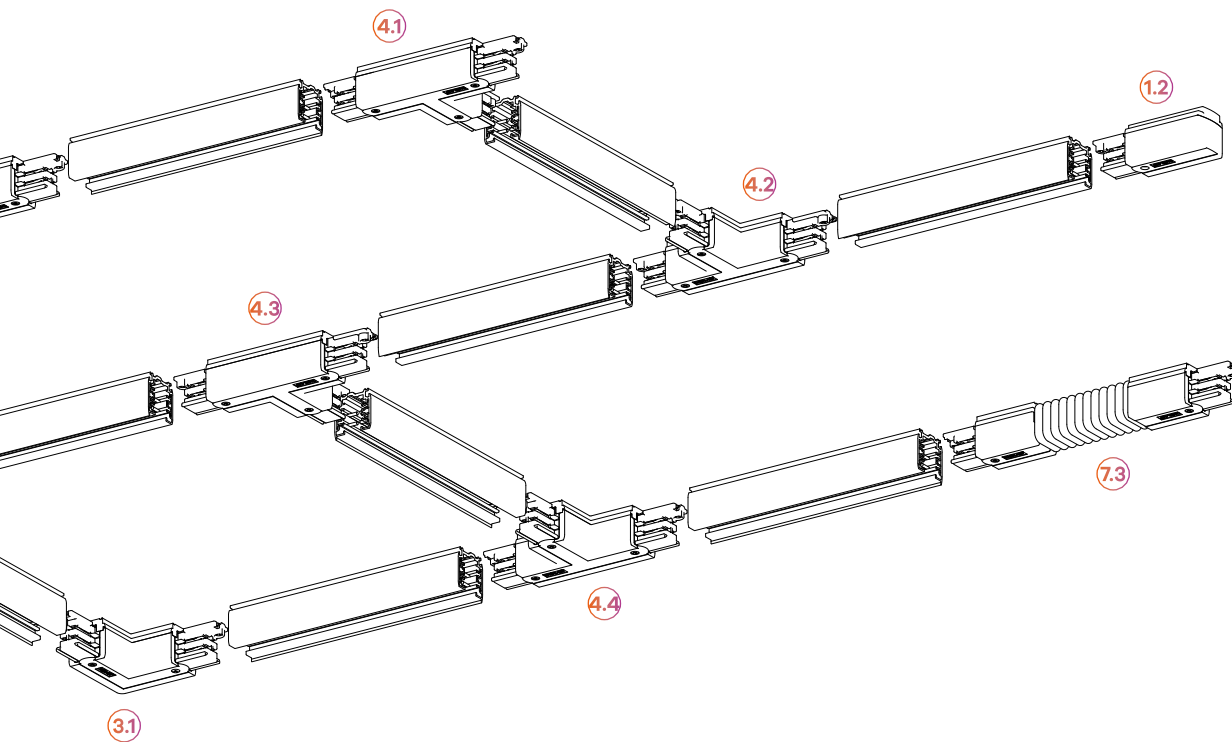
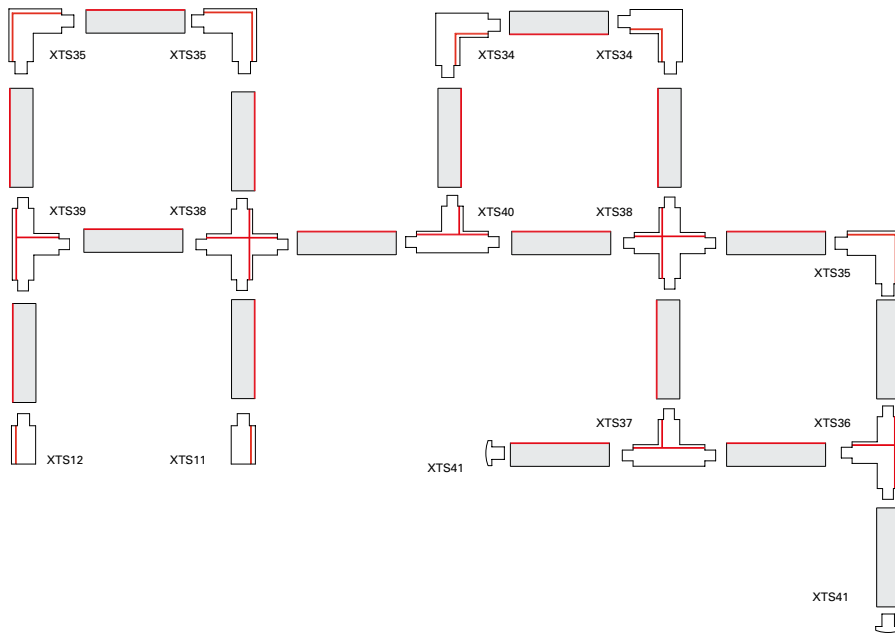

01. Seleccionar sistema de carril

TRACK SYSTEM - SISTEMA DE CARRIL

Empotrar

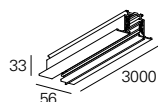

HF
DALI

CÓDIGO*
XTSF4300-▲
XTSCF6300-▲

Superficie

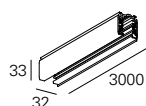

HF
DALI

CÓDIGO*
XTS4300-▲
XTSC6300-▲



*Sustituya los símbolos para completar el código

Color	▲
■ Aluminio	1
■ Negro	2
□ Blanco	3

02. Seleccionar alimentación

ALIMENTACIÓN

Terminal - Derecho

HF
DALI

CÓDIGO*
XTS11-▲
XTSC611-▲

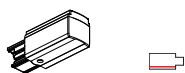

T - Exterior Derecho

HF
DALI

CÓDIGO*
XTS36-▲
XTSC636-▲

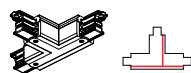

L - Interior

HF
DALI

CÓDIGO*
XTS34-▲
XTSC634-▲

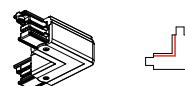

Terminal - Izquierdo

HF
DALI

CÓDIGO*
XTS12-▲
XTSC612-▲



T - Interior Izquierdo

HF
DALI

CÓDIGO*
XTS37-▲
XTSC637-▲

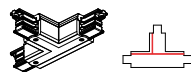

L - Exterior

HF
DALI

CÓDIGO*
XTS35-▲
XTSC635-▲

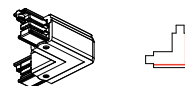

T - Exterior Izquierdo

HF
DALI

CÓDIGO*
XTS39-▲
XTSC639-▲

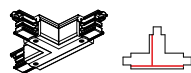

Central

HF
DALI

CÓDIGO*
XTS14-▲
XTSC614-▲

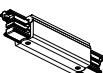

T - Interior Derecho

HF
DALI

CÓDIGO*
XTS40-▲
XTSC640-▲

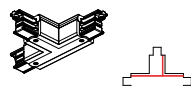

X

HF
DALI



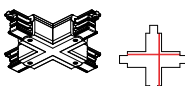







CÓDIGO*
XTS38-▲
XTSC638-▲



*Sustituya los símbolos para completar el código

Color	▲
■ Aluminio	1
■ Negro	2
□ Blanco	3

03. Seleccionar opciones

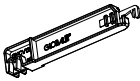
OPCIONES		Código*
Fijación		
SKB 10		SKB10-▲
SKB 12		SKB12-▲
Conector		
Conector recto HF		XTS21-▲
Conector recto DALI		XTSC621-▲
Conector flexible HF		XTS23-▲
Conector flexible DALI		XTSC623-▲
Conector ajustable HF		XTS24-▲
Tapa HF/DALI		XTS41-▲
Tapas para empotrar		
XTSF 10		XTSF610-▲
XTSF 30		XTSF30-▲
Herramienta		XTSV12



*Sustituya los símbolos para completar el código

Color	▲
■ Aluminio	1
■ Negro	2
□ Blanco	3



Detalles del producto



Carril de empotrar



Carril de superficie

INFORMACIÓN TÉCNICA



Leyenda

 <p>Producto fabricado conforme con la Directiva de Compatibilidad Electromagnética 2004/108/CE y con la Directiva para Equipamiento de Baja Tensión 2006/95/CE.</p>	 <p>Rotación horizontal máxima y/o inclinación vertical de la luminaria en grados (°).</p>	
 <p>Class I - Aparatos de iluminación con un terminal de tierra para protección, al cual están conectadas todas las partes metálicas, de forma que las partes conductoras accesibles no puedan permanecer activas en caso de defecto del aislamiento principal.</p>	<p>HF Driver con output fijo.</p>	<p>CRI CRI>90 - El índice de reproducción cromática nos indica la capacidad de una fuente de luz para reproducir fielmente los colores, en comparación con una fuente de luz ideal o natural (Luz día CRI=100). Un índice de reproducción de color entre 90 y 100 se considera muy bueno y entre 80 y 90 bueno.</p>
 <p>Class II - Aparatos de iluminación en que las partes metálicas no están accesibles. Normalmente son aparatos con doble aislamiento, o con todas las partes metálicas aisladas. No necesita de terminal tierra para protección.</p>	<p>DALI Digital Addressable Lighting Interface - Driver DALI para regulación de flujo.</p>	
 <p>Class III - Aparatos de iluminación que trabajan a una tensión de seguridad reducida de 24V. No necesita de terminal tierra para protección.</p>	<p>TouchDIM TouchDIM ofrece la oportunidad de controlar la iluminación sin ningún dispositivo de control adicional. TouchDIM no forma parte del protocolo estándar DALI. TouchDIM permite el control a través de pulsadores (en vez de interruptores).</p>	
<p>IP XX Índice de protección contra la penetración de objetos sólidos y líquidos.</p>	<p>SwitchDIM La función SwitchDIM permite, a través de una pulsación del interruptor la regulación de la intensidad de luz. Un breve toque (<0.6s), enciende o apaga la luminaria. Cuando se presiona durante 2 segundos aprox., el sistema comienza a contar los impulsos, permitiendo que la luminaria aumente o disminuya la intensidad de la luz.</p>	
<p>IP XX/YY IP XX/YY Luminaria con IPxx en el cuerpo el IPyy en la parte visible (aro/marco).</p>	<p>EM 3h (K3) La indicación de disponibilidad de Kit de emergencia de 3 horas, es válida sólo en la versión con driver HF (On/Off). Versión DALI disponible bajo pedido.</p>	<p>Lxx B(yyy) La degradación del flujo luminoso - El flujo luminoso de un módulo LED disminuye a lo largo de su tiempo de vida. Esta degradación se caracteriza por el valor de L. La vida útil de un módulo LED que integra una luminaria está relacionada con la depreciación del flujo luminoso a una determinada temperatura ambiente. L70, L80 o L90 indica la cantidad de lúmenes (en % con relación a el flujo luminoso) que permanecerá después del final de la vida útil del módulo LED, es decir, L80 significa que el módulo LED mostrará el 80% de su flujo luminoso inicial. Es importante tener en consideración que el valor de L está relacionado con el número de horas de funcionamiento, que consecuentemente definirá la vida útil del módulo LED. El valor B define la cantidad de módulos LED que están por debajo de lo especificado en el valor L, es decir, L70B10 significa que el 10% de los módulos LED están por debajo del 70% del flujo luminoso inicial y respectivamente un 90% estará por encima de un 70% del valor inicial.</p>
<p>IK XX Índice de protección mecánica contra impactos mecánicos.</p>	<p>UGR Unified Glare Rating - Índice de deslumbramiento unificado. Los valores de UGR presentados en este catálogo son indicativos y están en consonancia con los planos de reflexión 70/50/20.</p>	
<p>XXX°C Resistencia al hilo incandescente, en grados Celsius (°C).</p>	<p>W Watt - Unidad de potencia.</p>	<p> Dimensión del área de corte para productos de empotrar, en milímetros (mm).</p>
<p>230V/50Hz Tensión y Frecuencia de alimentación de la luminaria.</p>	<p>lm Lumen - Unidad de medida del flujo luminoso, utilizada para describir la cantidad de luz emitida por una fuente de luz.</p>	<p>K Temperatura de color en Kelvin (K).</p>
 <p>La luminaria no puede ser cubierta con material aislante térmico.</p>	<p>lm/W Eficacia luminosa - Indica el grado eficiente de la fuente de luz a convertir energía eléctrica en luz, en lm/W.</p>	<p> Indicación del ángulo del haz de luz - En las tablas son indicados los ángulos aproximados, en grados (°), basados en el plano CO-C180.</p>
 <p>Producto con 5 años de garantía (verifique en las Condiciones Generales de Venta).</p>		

Índices de protección

ÍNDICE DE PROTECCIÓN - IP _ _

Este código es representado como "IP xx", en que "xx" son los dos dígitos que suministran información relativa al índice de protección del aparato contra objetos sólidos (1º dígito) y líquidos (2º dígito), definidos por la norma EN 60 529, por las directivas UTEC 20 010 y DIN 40 050.

1º Dígito

(Protección contra objetos sólidos)

0	Sin protección.
1	Protegido contra cuerpos sólidos >50mm.
2	Protegido contra cuerpos sólidos >12mm.
3	Protegido contra cuerpos sólidos >2,5mm.
4	Protegido contra cuerpos sólido >1mm.
5	Protegido contra polvo.
6	Totalmente protegido contra el polvo.

2º Dígito

(Protección contra líquidos)

0	Sin protección.
1	Protegido contra caídas verticales de gotas de agua (condensación).
2	Protegido contra caídas de agua > 15° en la vertical.
3	Protegido contra caídas de agua > 60° en la vertical.
4	Protegido contra lanzamiento de agua en todas las direcciones.
5	Protegido contra chorros de agua en todas las direcciones.
6	Protegido contra chorros de agua (alta presión).
7	Protegido contra inmersión temporal.
8	Protegido contra efectos prolongados de inmersión en baja presión.

ÍNDICE DE PROTECCIÓN MÉCANIQUE - IK _ _

Este código es representado como "IKxx" en que "xx" son los dígitos que suministran información relativa al índice de protección mecánica del aparato contra impactos mecánicos, definidos por la norma EN 50 102. Los dígitos "xx" representan el valor de energía de impacto, medida en Julios, en conformidad con la siguiente escala:

00	Sin protección.
01	Protección contra impactos mecánicos hasta 0,15J
02	Protección contra impactos mecánicos hasta 0,2J
03	Protección contra impactos mecánicos hasta 0,35J
04	Protección contra impactos mecánicos hasta 0,5J
05	Protección contra impactos mecánicos hasta 0,7J
06	Protección contra impactos mecánicos hasta 1J
07	Protección contra impactos mecánicos hasta 2J
08	Protección contra impactos mecánicos hasta 5J
09	Protección contra impactos mecánicos hasta 10J
10	Protección contra impactos mecánicos hasta 20J

Tabla de resistencia química

PRODUCTOS QUÍMICOS	PC	PMMA	PES	AL
Aceite mineral	+	+	+	+
Aceites y grasas	-	+	+	+
Acetato de etilo	-	-	-	+
Acetona	-	-	-	+
Ácido acético 10%	+	+	+	+
Ácido carbónico	-	-	+	+
Ácido cítrico 20%	+	+	+	+
Ácido clorhídrico 5%	+	+	~	-
Ácido nítrico 20%	~	~	-	-
Ácido sulfúrico hasta 50%	+	+	-	-
Ácido sulfúrico concentrado	-	-	-	-
Agua oxigenada hasta 30%	+	+	-	+
Agua oxigenada a más de 30%	~	~	-	+
Alcohol concentrado	-	-	~	~
Alcohol etílico 30%	+	~	+	~
Amoníaco a 25%	-	+	-	+
Anilina	-	-	-	+
Benceno	-	-	-	+
Cemento	+	+	+	~
Clima marítimo	+	+	+	~
Cloro líquido (vapores)	-	-	-	-
Clorofenol	-	-	-	+
Cloroformo	-	-	-	+
Cloruro de calcio	+	+	+	+
Cloruro de sodio	+	+	+	~
Diclorometano	-	-	-	~
Diesel	-	+	+	+
Diesel - nafta	~	+	+	+
Éter	-	-	~	+
Fenol	-	-	-	~
Hidróxido de sodio	+	+	+	-
Metanol	-	-	+	+
Nitrato de calcio	+	+	+	+
Nitrato de potasio	+	+	+	+
Oxígeno	+	+	+	+
Ozono	+	+	+	+
Soda cáustica 5%	-	+	-	-
Sulfato de aluminio	+	+	+	+
Sulfato de cobre	+	+	+	-
Sulfato de magnesio	+	+	+	+
Sulfato de sodio	+	+	+	+
Sulfato de Zinc	+	+	+	~
Tetracloruro de carbono	-	-	-	+
Tolueno	-	-	-	+
Tricloroetileno	-	-	-	+
Yodo	-	-	+	~
Tricloroetileno	-	-	-	+

LEYENDA

PC (Policarbonato), PMMA (Acrílico), PES (Poliéster), AL (Aluminio)
+ Resistente, ~ Parcialmente resistente, - NO resistente

NOTA

• Los datos en la tabla se refieren a una temperatura de 22 ° C considerando que el grado de saturación de productos químicos y la temperatura ambiente afectan a la velocidad y la intensidad de reacciones, dependiendo del tipo y de la composición de las sustancias implicadas.

G	6th ELEMENT /C	48	F	FESAL	422	R	ROFY 60	172
	6th ELEMENT /W	54		FESAL IP	426		ROFY 60 D/I	176
	6th ELEMENT *	36		FESAL Sq	424		ROFY 60 Sq	198
	6th ELEMENT	40		FESAL Sq IP	428		ROFY 60 Sq D/I	202
	6th ELEMENT FIX	44		FOCUS 2	360		ROFY 85 /E	180
A	AURA	452	G	GLAM /W	268		ROFY 85	182
	AVL	794		GLAM /WE	264		ROFY 85 D/I	186
	AVT	656		GLAM	248		ROFY 85 IP /C	192
B	bLED	642		GLAM 48V	274		ROFY 85 IP /E	190
C	CAB	758	H	HOLI Sq /AS Max	404	S	SENSE	416
	CLOUD	634		HOLI Sq /C	408		SLIM	456
	CONCEPT D 35	122		HOLI Sq /C Max	410	T	TALEA	678
	CONCEPT D 35 D/I	126		HOLI Sq /C Mini	406		TALEA Glare /C	686
	CONCEPT O 35 /E	104		HOLI Sq /T	390		TALEA Glare	690
	CONCEPT O 35	106		HOLI Sq /T Max	392		TALEA HRZ	678
	CONCEPT O 35 D/I	110		HOLI Sq /T Mini	388		TALEA Line	682
	CONCEPT O 65	146		HOLI Sq	398		TEI	638
	CONCEPT O 65 D/I	150		HOLI Sq Max	400		THE	658
	CONCEPT S 35 /E	90		HOLI Sq Mini	396		THS	660
	CONCEPT S 35	94	L	LNE	646		TRN	790
	CONCEPT S 35 D/I	98		LNE IP	662		TTP 100	724
	CONCEPT S 65	138		LNS	650		TTP 100 Line	728
	CONCEPT S 65 D/I	142		LNS IP	664		TTP 50 360 HRZ	734
	CONCEPT Sq 35	114	N	NOAH /D	68		TTP 50 360 VRT	738
	CONCEPT Sq 35 D/I	118		NOAH	62		TTP 50	708
	CORA /C	628	O	OREO /C	214		TTP 50 Line	712
	CORA /E	620		OREO In	216		TTP 70	716
	CORA	624		OREO Linea Down	232		TTP 70 Colour	746
D	DORIS	752		OREO Linea Up	236		TTP 70 Line	720
	DYNA /C	442		OREO Out	220	V	VEGA /E	366
	DYNA	438		OREO V In	224		VEGA	372
	DYNA IP	444		OREO V Out	228		VEGA IP /E	378
	DYNA MINI /C	434	P	PAS	782		VEGA IP	382
	DYNA MINI	430		PAS Line	784		VEGA Sq /E	368
	DYNA MINI Sq	432	R	REBA 50 /E	522		VEGA Sq IP /E	380
	DYNA Sq	440		REBA 50 /E bOPTICS	474		VEGA Sq	374
	DYNA Sq IP	446		REBA 50 /E bOPTICS Line	478		VISA	460
E	ELI /C	342		REBA 50 /E Line	526	Z	ZLP /C	772
	ELI /E 1	328		REBA 50 /T	512		ZLP /E	766
	ELI /E 2	330		REBA 50 /T Line	516		ZLP /W	774
	ELI /W	348		REBA 50 /W	560		ZLP	768
	ELI /W D/I	352		REBA 50 /W Line	564			
	ELI	338		REBA 50	532			
	ELI 50 /C	300		REBA 50 bOPTICS	484			
	ELI 50 /E 1	284		REBA 50 bOPTICS Line	488			
	ELI 50 /E 2	286		REBA 50 D/I	550			
	ELI 50 /W	304		REBA 50 D/I Line	554			
	ELI 50 /W D/I	308		REBA 50 HEXA	546			
	ELI 50	294		REBA 50 Line	536			
	ELI 50 Spot /C	318		REBA 65 /E	584			
	ELI 50 Spot /E 1	314		REBA 65 /E Line	588			
	ELI 50 Spot /E 2	316		REBA 65 /T	574			
	ELI 50 Spot Track	320		REBA 65 /T Line	578			
	ELI 50 Sq /C	302		REBA 65	594			
	ELI 50 Sq /E 1	288		REBA 65 D/I	604			
	ELI 50 Sq /E 2	290		REBA 65 D/I Line	608			
	ELI 50 Sq /W	306		REBA 65 Line	598			
	ELI 50 Sq /W D/I	310		ROFY 60 /T	166			
	ELI 50 Sq	296		ROFY 60 /T D/I	168			
	ELI Sq /C	344						
	ELI Sq /E 1	332						
	ELI Sq /E 2	334						
	ELI Sq /W	350						
	ELI Sq /W D/I	354						
	ELI Sq	340						

INDELAGUE GROUP

SEDE

INDELAGUE - INDÚSTRIA ELÉTRICA
DE ÁGUEDA S.A.
Rua da Mina 465 | Covão
Zona industrial EN1 Norte
3750-792 Trofa
ÁGUEDA | PORTUGAL
T. +351 234 612 310
indelague@indelague.pt

ESPAÑA

INDELAGUE ESPAÑA, S.L.
Avenida del Ejército, nº 8 - 1º C
C.P. 15006 | A CORUÑA | ESPAÑA
comercial@indelague.com

PUBLICACIÓN

Indelague SA

EDITOR

Indelague SA

CONCEPTO Y DESIGN

Indelague SA

EDICIÓN

Julio 2024

Hecho en Portugal

CATÁLOGO INDELAGUE - VOLUMEN 15

Versión en Español
Impreso en Portugal

Todos los datos contenidos en este catálogo no constituyen ningún tipo de compromiso para INDELAGUE - Indústria Eléctrica de Águeda, SA. La empresa, se reserva el derecho de cambiar o modificar cualquier información declarada sin previo aviso. Se prohíbe la reproducción de este catálogo o parte del mismo.
Datos eléctricos y ópticos = +/- 10%.

