

The Light Book.

INDELAGUE GROUP

iNDELAGUE ROXO lighting

ÍNDICE GERAL



6th ELEMENT	29	LNS IP	664
AURA	451	NOAH	59
AVL	793	OREO	207
AVT	656	PAS	781
bLED	641	REBA	495
CAB	757	REBA 50 bOPTICS	465
CLOUD	633	ROFY	155
CONCEPT 35	71	ROFY SQ	197
CONCEPT 65	131	SENSE	415
CORA	617	SLIM	455
DORIS	751	TALEA	669
DYNA	429	TEI	637
ELI	325	THE	658
ELI 50	281	THS	660
FESAL	419	TRN	789
FOCUS 2	359	TTP	695
GLAM	241	TTP 50 360	733
HOLI	387	TTP 70 Colour	743
LNE	645	VEGA	363
LNE IP	662	VISA	459
LNS	649	ZLP	765

ILUMINAÇÃO ARQUITETURAL	27
SISTEMAS E PERFIS DE ALUMÍNIO	463
ILUMINAÇÃO TÉCNICA	615
AMBIENTES ASSÉTICOS	653
LUMINÁRIAS TUBULARES	667
LUMINÁRIAS ESTANQUES	749
AMBIENTES INDUSTRIAIS E DESPORTIVOS	755
LUMINÁRIAS ANTI-VANDALISMO	763
RÉGUAS E SISTEMAS DE CALHA	779
SISTEMA DE CALHA	797
INFORMAÇÕES TÉCNICAS	803



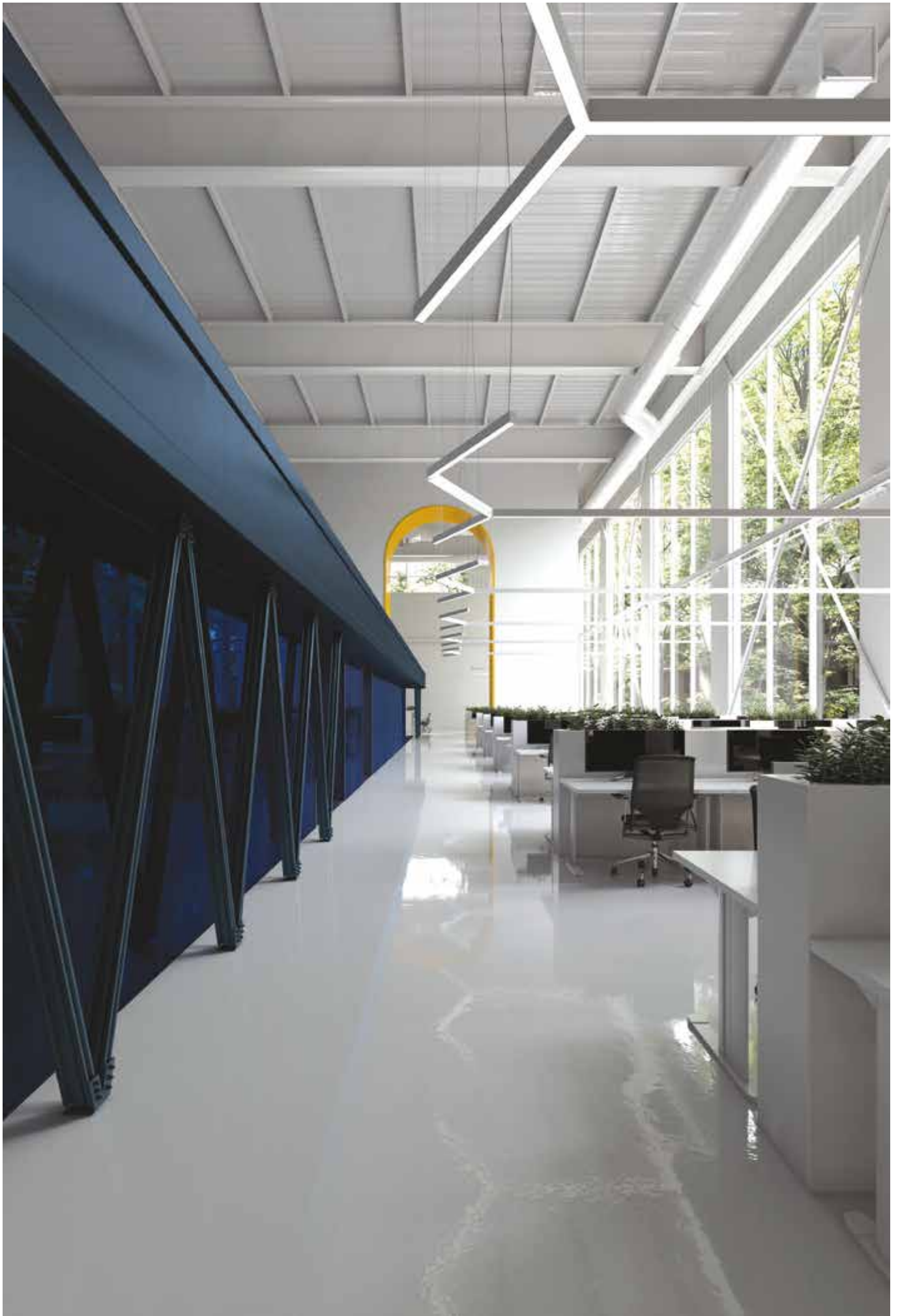







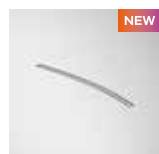





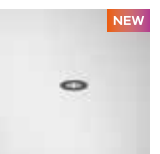

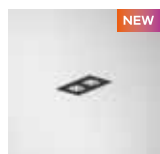
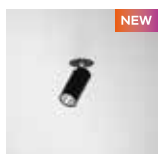

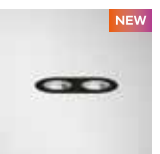
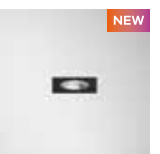











Todos os dados contidos neste catálogo não constituem nenhum compromisso por parte da INDELAGUE - Indústria Eléctrica de Águeda, SA., o que lhe reserva o direito de efetuar as modificações que considere oportunas, sem aviso prévio. É interdita a reprodução, ainda que parcial deste catálogo. Dados elétricos / óticos sujeitos a tolerância de +/- 10%. Temperatura de cor sujeita a tolerância de +/- 150K, exceto quando claramente especificado. Todos os valores se aplicam a uma temperatura ambiente de 25°C.



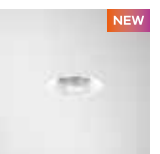

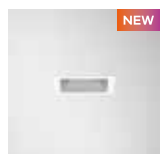



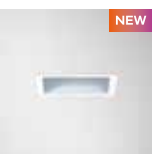





































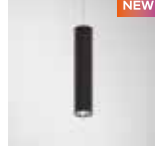

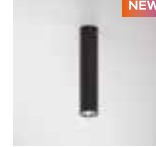



Índice

ILUMINAÇÃO ARQUITETURAL

ENCASTRAR

 NEW	 NEW	 NEW	 NEW	 NEW	 NEW	 NEW	 NEW
CONCEPT S 35 / E 90	CONCEPT O 35 / E 104	ROFY 60 / T 166	ROFY 60 / T D/I 168	ROFY 85 / E 180	ROFY 85 IP / E 190	ELI 50 / E 1 284	ELI 50 / E 2 286
 NEW	 NEW	 NEW	 NEW	 NEW	 NEW	 NEW	 NEW
ELI 50 Sq / E 1 288	ELI 50 Sq / E 2 290	ELI 50 Spot / E 1 314	ELI 50 Spot / E 2 316	ELI / E 1 328	ELI / E 2 330	ELI Sq / E 1 332	ELI Sq / E 2 334
 NEW	 NEW	 NEW	 NEW	 NEW	 NEW	 NEW	 NEW
VEGA / E 366	VEGA Sq / E 368	VEGA IP / E 378	VEGA Sq IP / E 380	HOLI Sq / T Mini 388	HOLI Sq / T 390	HOLI Sq / T Max 392	HOLI Sq Mini 396
 NEW	 NEW	 NEW	 NEW	 NEW	 NEW	 NEW	 NEW
HOLI Sq 398	HOLI Sq Max 400	HOLI Sq / AS Max 404	SENSE 416	FESAL 420	FESAL Sq 422	FESAL IP 424	FESAL Sq IP 426
 NEW	 NEW	 NEW	 NEW	 NEW	 NEW		
DYNA MINI 430	DYNA MINI Sq 432	DYNA 438	DYNA Sq 440	DYNA IP 444	DYNA Sq IP 446		

SALIENTE / SUSPENSA

 6th ELEMENT + 36	 6th ELEMENT 40	 6th ELEMENT FIX 44	 6th ELEMENT /C 48	 NOAH 62	 CONCEPT S 35 94	 CONCEPT S 35 D/I 98	 CONCEPT O 35 106
 CONCEPT O 35 D/I 110	 CONCEPT Sq 35 114	 CONCEPT Sq 35 D/I 118	 CONCEPT D 35 122	 CONCEPT D 35 D/I 126	 CONCEPT S 65 138	 CONCEPT S 65 D/I 142	 CONCEPT O 65 146
 CONCEPT O 65 D/I 150	 ROFY 60 172	 ROFY 60 D/I 176	 ROFY 85 182	 ROFY 85 D/I 186	 ROFY 85 IP /C 192	 ROFY 60 Sq 198	 ROFY 60 Sq D/I 202
 OREO /C 214	 OREO In 216	 OREO Out 220	 OREO V In 224	 OREO V Out 228	 OREO Linea Down 232	 OREO Linea Up 236	 GLAM 248
 GLAM S4 254	 GLAM S8 258	 ELI 50 294	 ELI 50 Sq 296	 ELI 50 /C 300	 ELI 50 Sq /C 302	 ELI 50 Spot /C 318	 ELI 338
 ELI Sq 340	 ELI /C 342	 ELI Sq /C 344	 VEGA 372	 VEGA Sq 374	 VEGA IP 382	 HOLI Sq /C Mini 406	 HOLI Sq /C 408
 HOLI Sq /C Max 410	 DYNA MINI /C 434	 DYNA /C 442					

Índice

PAREDE



6th ELEMENT /W
54



GLAM /WE
264



GLAM /W
268



ELI 50 /W
306

NEW



ELI 50 Sq /W
306

NEW



ELI 50 /W D/I
308

NEW



ELI 50 Sq /W D/I
310

NEW

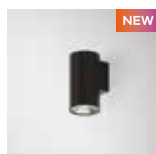

ELI /W
348

NEW

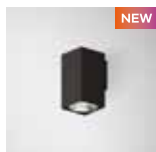

ELI Sq /W
350

NEW



ELI /W D/I
352

NEW



ELI Sq /W D/I
354

NEW



AURA
452



SLIM
456



VISA
460

PROJETOR E CALHA



GLAM 48V
274



ELI 50 Spot Track
320

NEW



FOCUS 2
360

NEW



Sistema de Calha
800

LUMINÁRIA DE MESA



NOAH /D
68

SISTEMAS E PERFIS DE ALUMÍNIO

ENCASTRAR

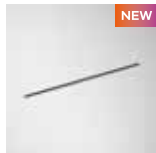

**REBA 50 /E
bOPTICS**
474

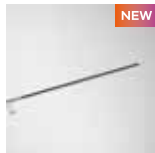

**REBA 50 /E
bOPTICS Line**
478



REBA 50 /T
512



REBA 50 /T Line
516



REBA 50 /E
522



REBA 50 /E Line
526



REBA 65 /T
574

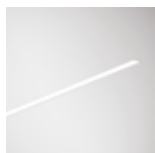

REBA 65 /T Line
578



REBA 65 /E
584



REBA 65 /E Line
588

SALIENTE / SUSPENSA



REBA 50 bOPTICS
484



**REBA 50 bOPTICS
Line**
488



REBA 50
532



REBA 50 Line
536



REBA 50 HEXA
546



REBA 50 D/I
550



REBA 50 D/I Line
554



REBA 65
594



REBA 65 Line
598



REBA 65 D/I
604



REBA 65 D/I Line
608

PAREDE



REBA 50 /W
560



REBA 50 /W Line
564

Índice

ILUMINAÇÃO TÉCNICA

ENCASTRAR



CORA / E
620



CLOUD
634



TEI
638



bLED
642



LNE
646

SALIENTE / SUSPENSA



CORA
624



CORA / C
628



LNS
650

AMBIENTES ASSÉTICOS

ENCASTRAR



AVT
656



THE
658



LNE IP
662

SALIENTE



THS
660



LNS IP
664

LUMINÁRIAS TUBULARES

SALIENTE / SUSPENSA



TALEA
678



TALEA HRZ
678



TALEA Line
682



TALEA Glare / C
686



TALEA Glare
690



TTP 50
708



TTP 50 Line
712



TTP 70
716



TTP 70 Line
720



TTP 100
724



TTP 100 Line
728



TTP 50 360 HRZ
734



TTP 50 360 VRT
738



TTP 70 Colour
746

LUMINÁRIAS
ESTANQUES

SALIENTE /
SUSPENSA

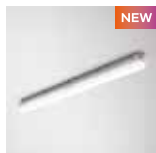

DORIS
752

AMBIENTES INDUSTRIAIS
E DESPORTIVOS

ENCASTRAR / SALIENTE /
SUSPENSA



CAB
758

LUMINÁRIAS
ANTI-
VANDALISMO

ENCASTRAR



ZLP /E
766

RÉGUAS E
SISTEMAS DE
CALHA

SALIENTE



TRN
790



AVL
794

SALIENTE /
SUSPENSA



ZLP
768

SUSPENSA



ZLP /C
772



PAS
782



ZLP /W
774



PAS Line
784

INTRODUÇÃO



Sobre nós

**Fabricamos iluminação desde o
começo da década de 80.
Temos orgulho do nosso
trabalho e da nossa história.**





Sobre nós

Somos especialistas em iluminação sustentável com tecnologia LED. Uma empresa familiar, localizada em Águeda, no coração de Portugal que opera como um player global com vendas independentes e parceiros em cerca de 35 países. Fundada em 1978, fomos pioneiros no desenvolvimento de iluminação técnica e arquitetural em Portugal, desde a nossa fundação até agora. Somos o primeiro fabricante português a estabelecer um portfólio de produção inteiramente baseado apenas em tecnologia LED. A estratégia corporativa para uma iluminação sustentável, combina responsabilidade ecológica com conhecimento tecnológico. Os nossos 100 funcionários, estão comprometidos e dedicados por forma a garantir que os nossos produtos não sejam apenas produtos, mas ferramentas de iluminação sustentáveis e adequadas ao seu projeto.

45 anos de história

Criar soluções de iluminação de perfeita qualidade e estética é a nossa paixão.

Há 45 anos que trabalhamos continuamente na luz do amanhã com uma abordagem de design única. Contribuímos para melhorar a qualidade da vida humana através da luz, oferecendo a luz certa para cada atividade a qualquer hora do dia

ou da noite. O desenvolvimento contínuo da carteira de produtos é impulsionado não só pela investigação e tecnologia mais recentes, mas sobretudo pela colaboração de longa data com arquitetos, engenheiros, designers de iluminação

e artistas internacionais de renome na sua atividade de projeto. As nossas luminárias são sempre adaptadas às necessidades individuais dos nossos clientes e das pessoas que utilizam os nossos produtos.

1978

Fundação da empresa.



1985-86

Desenvolvimento dos primeiros produtos de iluminação IRN e IAI.
Desenvolvimento de produtos de iluminação IAP e início da produção de sistemas de caminhos de cabos.

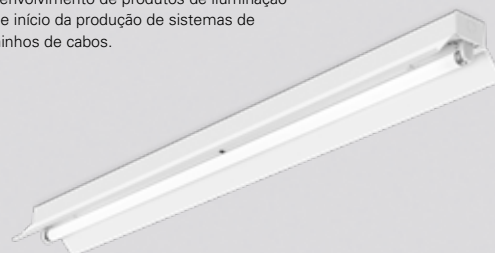

1987

Expansão da capacidade de fabrico com a construção de um novo pavilhão de 900 m² e o início da produção de refletores em alumínio para os modelos LAE e LAS.



1993

Expansão da capacidade de fabrico com a construção de um novo pavilhão de 1000 m².



2007

Construção dos novos Headquarters.
Um investimento de 10 milhões de euros possibilitaram a construção de uma nova fábrica com 17000 m².
Foi também adquirido um novo laboratório fotométrico, diversas máquinas CNC e um novo sistema de linha de pintura.



2012

A marca **ROXO LIGHTING** é criada.
Início da produção de iluminação arquitetural, incluindo uma nova gama de downlights.

ROXO lighting

2014

Desenvolvimento e início da produção da gama REBA 65 em perfil de alumínio, da gama TTP 70 de elevado índice de proteção e da gama ZLP de elevada resistência mecânica e anti vandalismo.

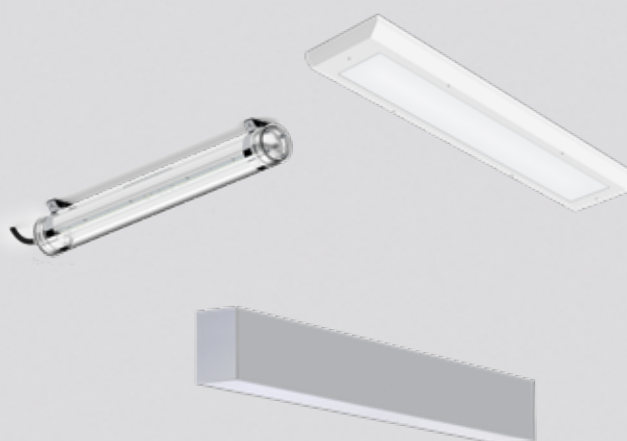

45 anos de história

2017

O **6th ELEMENT** ganhou o prestigiado German Design Award - Special Mention 2017.



2018

O júri do German Design Award atribuiu à luminária **NOAH** do Grupo Indelague a distinção de WINNER 2018 - Excellent Product Design Lighting.



2019

Em 2019 decidimos dar à nossa unidade fabril um perfil mais ecológico e socialmente sustentável através da instalação de 600 painéis solares fotovoltaicos com uma potência máxima de 295W com capacidade para produzir 235000 kWh de energia elétrica por ano a partir do sol. Permitindo a redução do impacto ambiental, evitando a emissão de 120 toneladas de CO2 por ano.

2020

A gama **TALEA** ganhou o aclamado German Design Award 2020, ganhando a categoria WINNER - Excellent Product Design Lighting.

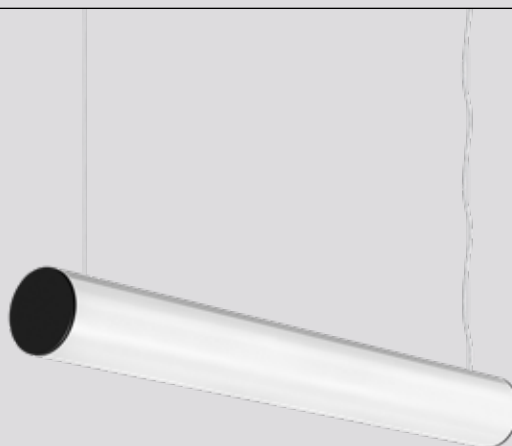

2021

O nosso produto **CONCEPT S 35** foi reconhecido pelo German Design Award 2021 com uma **SPECIAL MENTION** na categoria de iluminação.

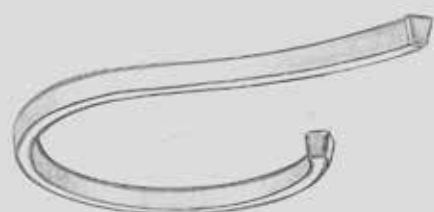

2022

6ª participação da Indelague na feira Light+ Building em Frankfurt na Alemanha, onde exibiu as suas soluções de iluminação que aliam inovação, sustentabilidade e design.

2023

Indelague marca **45 anos** de excelência e conhecimento na área de iluminação. Remodelação do Showroom.



I&D e Design



Os nossos produtos são o resultado de pesquisas constantes e contínuas em diferentes áreas.

I&D e Design

O departamento de I&D (Investigação e Desenvolvimento) ocupa uma posição preponderante nas atividades do Grupo Indelague. A relação próxima com os nossos clientes é fundamental para acompanhar os últimos desenvolvimentos do mercado, o que motiva a nossa equipa de I&D a pesquisar novos materiais e a realizar testes cada vez mais rigorosos, permitindo que o Grupo Indelague garanta um

elevado nível tecnológico e padrões de qualidade únicos. A equipa de I&D dedica-se à pesquisa e ao desenvolvimento de produtos LED inovadores, através de testes (técnicos e fotométricos) no nosso próprio laboratório e através de parcerias com laboratórios independentes. Os nossos produtos são o resultado de pesquisas constantes e contínuas em diferentes áreas. Desde os componentes eletrónicos

e óticos, ao design e fotometria, orientados para os produtos que incorporam tecnologia avançada com materiais sustentáveis e um design intemporal. Desenvolvemos constantemente processos de produção altamente avançados para alcançar um menor consumo de energia, maior vida útil do produto, temperaturas operacionais otimizadas, novos efeitos de luz e excelentes desempenhos.



Produtos em destaque

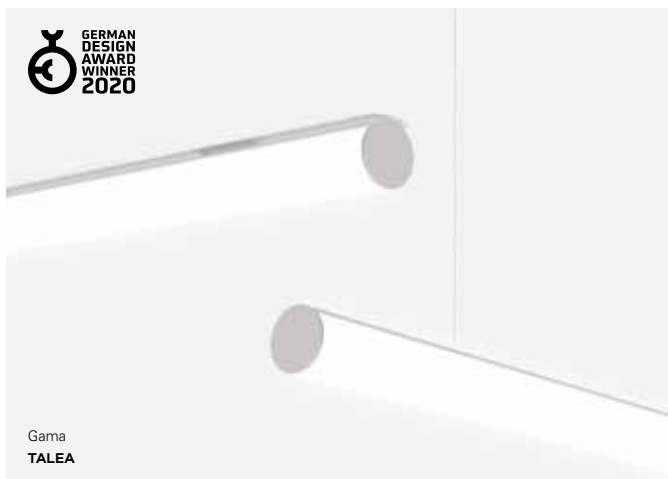

Produtos em destaque

Apresentamos as nossas últimas soluções de iluminação LED. Inovadoras, confiáveis e eficientes, que se adaptam a qualquer espaço e integram qualquer tipo de ambiente. Foram concebidas para aplicações versáteis, soluções verdadeiramente únicas para qualquer espaço de arquitetura. As nossas luminárias são ferramentas de iluminação que integram a mais elevada tecnologia e níveis de desempenho de iluminação excepcionais, o que lhes permite obter efeitos de iluminação acentuados, precisos ou uniformes. As novas gamas oferecem novas perspectivas de design de iluminação para escritórios, salas de leitura, instalações de educação e edifícios administrativos.

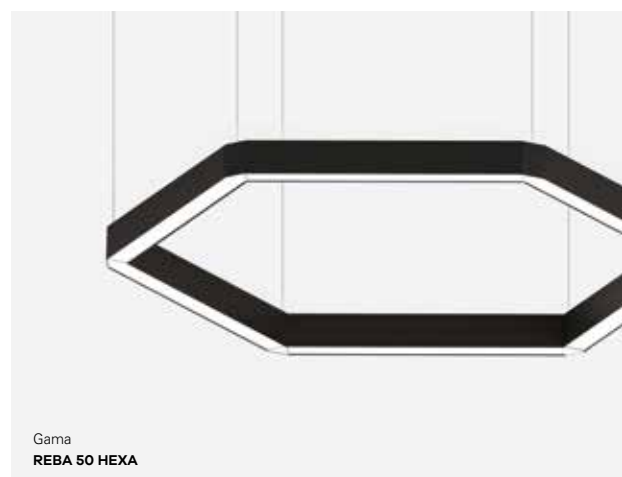



**Luz é muito mais do
que design, material
e tecnologia.
A luz é uma experiência!**



Projetos referência





INTRODUÇÃO

Rodi
Aveiro, Portugal

Projetos referência

Definimos continuamente novas formas de criar produtos de iluminação para novos contextos de aplicação.

Os projetos culturais, sociais e urbanos oferecem-nos novas oportunidades e know-how, que permite destacar detalhes, superfícies e volumes arquitetónicos. A iluminação evolui rapidamente para uma profunda revolução arquitetónica. É um elemento fundamental para a qualidade e bem-estar de qualquer tipo de ambiente,

incluindo escritórios, lojas de retalho, museus, instituições de ensino, residências, parques e jardins. O Grupo Indelague fornece soluções de iluminação sofisticadas e de valor acrescentado. Temos gamas de produtos que abrangem vários setores de aplicação. Adquirimos ao longo dos anos experiência e conhecimento para atender às necessidades funcionais e estéticas dos seus projetos. Cada projeto requer uma abordagem personalizada,

e nesse sentido criámos o Departamento de Projetos de Iluminação que oferece o suporte necessário aos nossos clientes, arquitetos, engenheiros, designers de interiores e light designers. Temos ainda pacotes excecionais de serviços e ferramentas de design ao seu dispor. A nossa equipa global trabalha com todas as partes interessadas para assim, obter o melhor resultado possível.



Utopia
Aalst, Belgium



Dr. Cautela Dental Clinic
Lisbon, Portugal

Capítulo
01

ILUMINAÇÃO ARQUITETURAL





6th ELEMENT

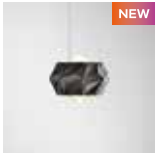

6th ELEMENT +
36



6th ELEMENT
40



6th ELEMENT FIX
44



6th ELEMENT /C
48



6th ELEMENT /W
54



Tipos de aplicação





1. Semi-encastar
Fixa

2. Parede
Orientável

3. Semi-encastar
Orientável

4. Suspensa

Minimalismo e tecnologia



140 mm

1. Corpo
Corpo em alumínio injetado, disponível em 3 cores.

2. LED
SDCM MacAdam ≤ 3 , temperatura de cor 3000K / 4000K, CRI > 90 e vida útil de 50.000h L80 B10.

3. Sistema ótico

- 3.1 Lente de 50°
 - 3.2 Lente de 80°
-

4. Suspensão e cabo de alimentação

Suspensões e cabo de alimentação disponíveis com comprimento de 1500, 3000 ou 6000 mm.

5. Caixa de alimentação

Caixas de alimentação nas versões de encastrar ou saliente. Disponíveis na cor branca ou preta.

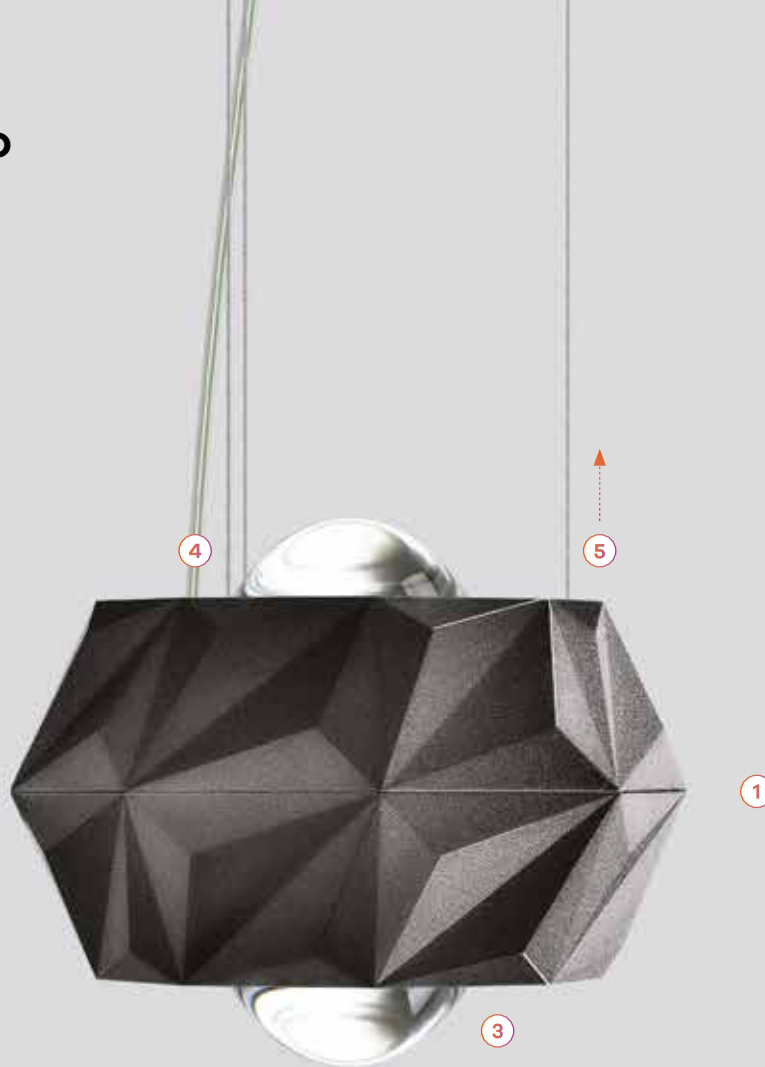

3.1. Lente de 50°

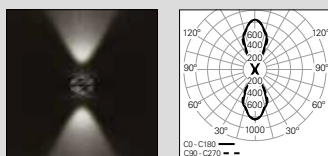

3.2. Lente de 80°

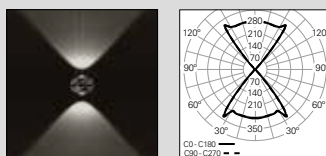

Defina a sua cor

ILUMINAÇÃO
ARQUITETURAL





6th ELEMENT +



Características do produto

Corpo

Alumínio injetado

**Acabamento**

Revestido a epóxi-poliéster

**Sistema ótico**

Lente

Fonte de luz

LED, RG1, CRI>90, MacAdam Step ≤3

**Vida útil LED**

50.000h @ L80, B10, Ta 25°C

Fonte de alimentação

Não incluída

01. Seleccionar versão

6th ELEMENT +

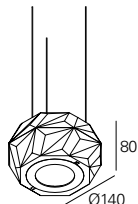

Lente de 50° | Direta / Indireta (50%/50%)

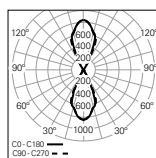

UGR	W	lm output	lm/W	mA	CÓDIGO*
≤10	17	2232	131	500	90568L0160▲0◆50

Lente de 80° | Direta / Indireta (50%/50%)

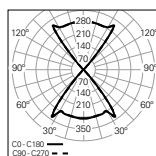

UGR	W	lm output	lm/W	mA	CÓDIGO*
≤19	17	2158	127	500	90568L0160▲0◆80

Lente de 50° | Direta

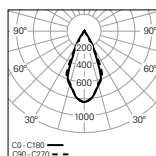

UGR	W	lm output	lm/W	mA	CÓDIGO*
≤13	9	1128	125	250	90578L0090▲0◆50
≤13	12	1512	126	350	90578L0160▲0◆50

Lente de 80° | Direta

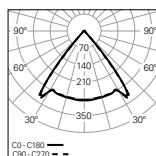

UGR	W	lm output	lm/W	mA	CÓDIGO*
≤25	9	1091	121	250	90578L0090▲0◆80
≤25	12	1428	119	350	90578L0160▲0◆80

6th ELEMENT +

- Para completar o produto é necessário encomendar cabo de alimentação/suspensão e caixa de alimentação em separado.



*Substitua os símbolos para completar o código

Cor	◆
□ Branco	W
■ Preto	B
■ Rusty chain	R

Temp. de Cor	◆
3000K	B
4000K	A

02. Selecionar caixa de alimentação

Encastrar - T55 Q200

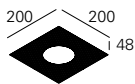

135x135

HF

	CÓDIGO*
10,5W 10-42V 250mA HF	972710♣
14,7W 10-42V 350mA HF	972711♣
21W 10-42V 500mA HF	972712♣

DALI

	CÓDIGO*
13W 09-52V 250mA DALI	972720♣
18,2W 09-52V 350mA DALI	972721♣
26W 09-52V 500mA DALI	972722♣

Saliente - T54 D120



HF

	CÓDIGO*
10W 30-42V 250mA HF	972730♣
15W 26-43V 350mA HF	972731♣
21W 30-42V 500mA HF	972732♣

DALI

	CÓDIGO*
12W 03-45V 250mA DALI	972740♣
16W 03-45V 350mA DALI	972741♣
20W 03-40V 500mA DALI	972742♣

CAIXA DE ALIMENTAÇÃO

- A caixa de alimentação de encastrar T55 Q200 é classe II.
- A caixa de alimentação saliente T54 D120 é classe I.
- Fonte de alimentação incluída na caixa de alimentação.

03. Selecionar opções

OPÇÕES	Código
Cabo de alimentação / Suspensão	
L1500 mm (x3)	942900
L3000 mm (x3)	942901
L6000 mm (x3)	942902



*Substitua os símbolos para completar o código

Cor	♣
□ Branco	W
■ Preto	B
■ Rusty chain	R



Detalhes do produto



Efeito de luz com lentes de 50°



Efeito de luz com lentes de 80°

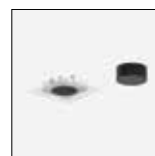

Caixas de alimentação



6th ELEMENT



Características do produto

Corpo

Alumínio injetado



Acabamento

Revestido a epóxi-poliéster



Sistema ótico

Lente

Fonte de luz

LED, RG1, CRI>90, MacAdam Step ≤3



Vida útil LED

50.000h @ L80, B10, Ta 25°C

Fonte de alimentação

Não incluída

01. Seleccionar versão

6th ELEMENT

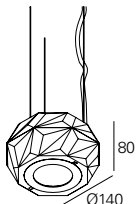

Lente de 50° | Direta / Indireta (50%/50%)

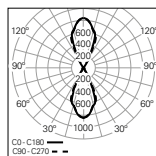

UGR	W	lm output	lm/W	mA	CÓDIGO*
≤10	17	2232	131	500	90280L0160▲0◆50

Lente de 80° | Direta / Indireta (50%/50%)

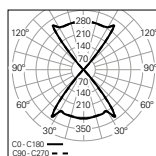

UGR	W	lm output	lm/W	mA	CÓDIGO*
≤19	17	2158	127	500	90280L0160▲0◆80

Lente de 50° | Direta

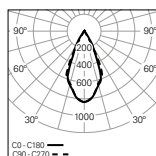

UGR	W	lm output	lm/W	mA	CÓDIGO*
≤13	9	1128	125	250	90328L0090▲0◆50
≤13	12	1512	126	350	90328L0160▲0◆50

Lente de 80° | Direta

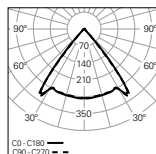

UGR	W	lm output	lm/W	mA	CÓDIGO*
≤25	9	1091	121	250	90328L0090▲0◆80
≤25	12	1428	119	350	90328L0160▲0◆80



*Substitua os símbolos para completar o código

Cor	◆
□ Branco	W
■ Preto	B
■ Rusty chain	R

Temp. de Cor	◆
3000K	B
4000K	A

6th ELEMENT

• Para completar o produto é necessário encomendar suspensão, cabo e caixa de alimentação em separado.

02. Selecionar caixa de alimentação

Encastrar - T12 Q200

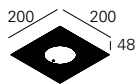

135x135

HF

	CÓDIGO*
10,5W 10-42V 250mA HF	971810♣
14,7W 10-42V 350mA HF	971811♣
21W 10-42V 500mA HF	971812♣

DALI

	CÓDIGO*
13W 09-52V 250mA DALI	971820♣
18,2W 09-52V 350mA DALI	971821♣
26W 09-52V 500mA DALI	971822♣

Saliente - T53 D120



HF

	CÓDIGO*
10W 30-42V 250mA HF	971830♣
15W 26-43V 350mA HF	971831♣
21W 30-42V 500mA HF	971832♣

DALI

	CÓDIGO*
12W 03-45V 250mA DALI	971840♣
16W 03-45V 350mA DALI	971841♣
20W 03-40V 500mA DALI	971842♣

CAIXA DE ALIMENTAÇÃO

- A caixa de alimentação de encastrar T12 Q200 é classe II.
- A caixa de alimentação saliente T53 D120 é classe I.
- Fonte de alimentação incluída na caixa de alimentação.

03. Selecionar opções

OPÇÕES	Código
Suspensão	
S14 L1500 mm (x3)	913300
S14 L3000 mm (x3)	913301
S14 L6000 mm (x3)	913302
Cabo de alimentação	
L1500 mm - 2 x 0,75 mm ²	942800
L3000 mm - 2 x 0,75 mm ²	942801
L6000 mm - 2 x 0,75 mm ²	942802



*Substitua os símbolos para completar o código

Cor	♣
□ Branco	W
■ Preto	B
■ Rusty chain	R



Detalhes do produto



Efeito de luz com lentes de 50°



Efeito de luz com lentes de 80°



Caixas de alimentação

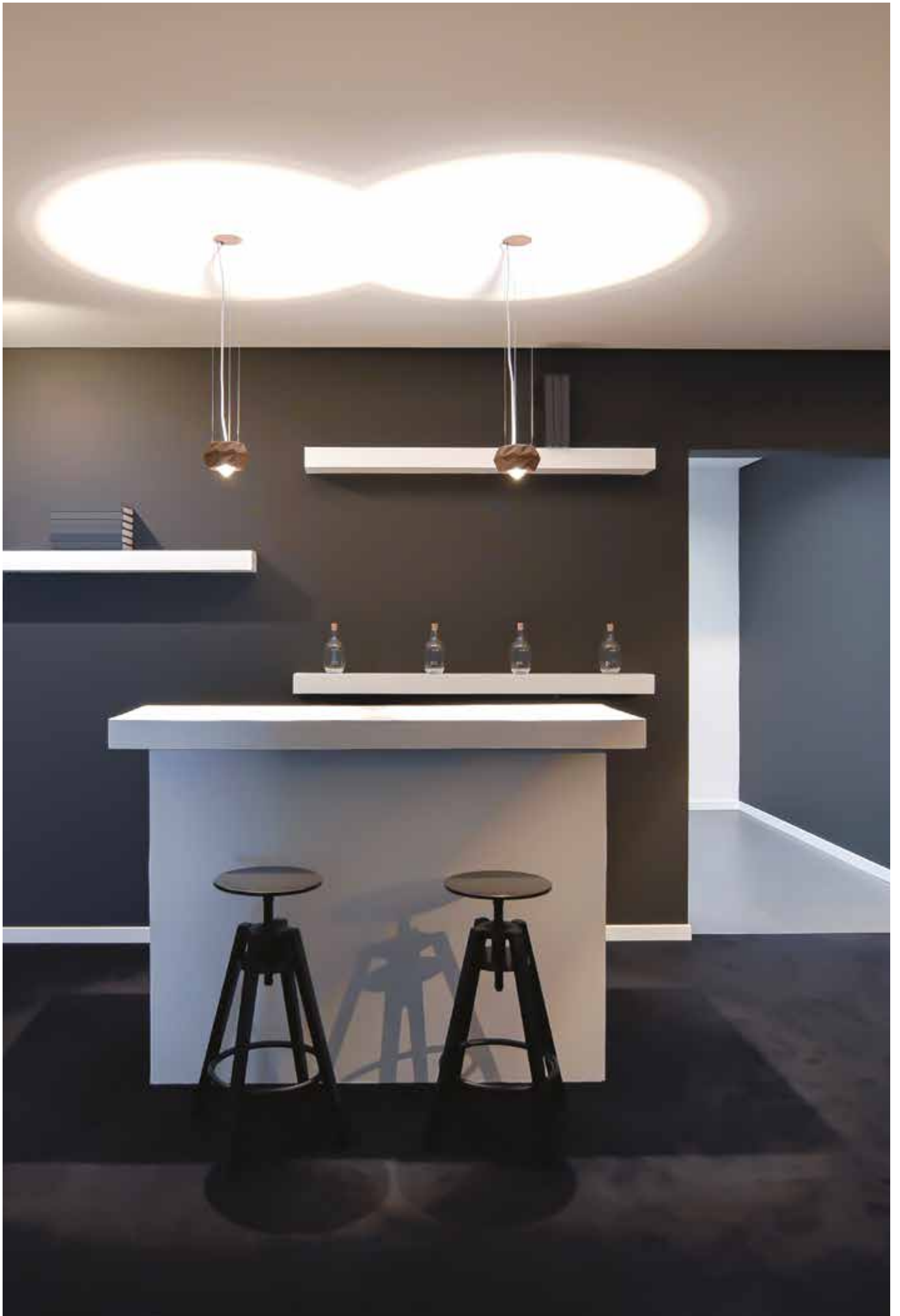

6th ELEMENT FIX



Características do produto

Corpo

Alumínio injetado



Acabamento

Revestido a epóxi-poliéster



Sistema ótico

Lente

Fonte de luz

LED, RG1, CRI>90, MacAdam Step ≤3



Vida útil LED

50.000h @ L80, B10, Ta 25°C

Fonte de alimentação

Não incluída

Espessura do teto

Para tetos entre 10-25 mm

01. Selecionar versão

6th ELEMENT FIX



Lente de 50°

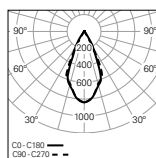

UGR	W	Im output	lm/W	mA	Ø	CÓDIGO*
≤13	9	1128	125	250	Ø125	90303L0090▲0♦50
≤13	12	1512	126	350	Ø125	90303L0160▲0♦50

Lente de 80°

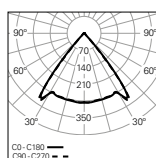

UGR	W	Im output	lm/W	mA	Ø	CÓDIGO*
≤25	9	1091	121	250	Ø125	90303L0090▲0♦80
≤25	12	1428	119	350	Ø125	90303L0160▲0♦80



*Substitua os símbolos para completar o código

Cor	↕
□ Branco	W
■ Preto	B
■ Rusty chain	R

Temp. de Cor	↕
3000K	B
4000K	A

6th ELEMENT FIX

• Para completar o produto é necessário encomendar fonte de alimentação em separado.

02. Selecionar opções

OPÇÕES

Fonte de alimentação HF

Driver 10,5W 10-42V 250mA HF	900002E
Driver 14,7W 10-42V 350mA HF	900004E

Fonte de alimentação DALI

Driver 13W 09-52V 250mA DALI+ PUSH	900102H
Driver 18,2W 09-52V 350mA DALI+ PUSH	900104H

Cabo de segurança em aço

L1500 mm	955000
----------	--------



Detalhes do produto



Efeito de luz com lente de 50°

Efeito de luz com lente de 80°

Orientável de teto





**1. Rotação de 355°
e inclinação de 90°**

O produto permite uma rotação de 355° e uma inclinação de 90° que proporciona versatilidade para iluminar objetos ou áreas específicas.



6th ELEMENT /C



Características do produto

Corpo

Alumínio injetado

**Acabamento**

Revestido a epóxi-poliéster

**Sistema ótico**

Lente

**Fonte de luz**

LED, RG1, CRI>90, MacAdam Step ≤3

Vida útil LED

50.000h @ L80, B10, Ta 25°C

**Fonte de alimentação**

Não incluída

01. Seleccionar versão

6th ELEMENT /C



Lente de 50°

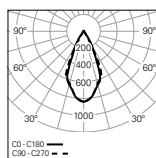

UGR	W	lm output	lm/W	mA	CÓDIGO*
≤13	9	1128	125	250	90278L0090▲0◆50
≤13	12	1512	126	350	90278L0160▲0◆50

Lente de 80°

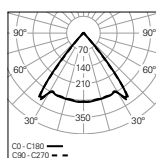

UGR	W	lm output	lm/W	mA	CÓDIGO*
≤25	9	1091	121	250	90278L0090▲0◆80
≤25	12	1428	119	350	90278L0160▲0◆80



*Substitua os símbolos para completar o código

Cor	◆
□ Branco	W
■ Preto	B
■ Rusty chain	R

Temp. de Cor	◆
3000K	B
4000K	A

6th ELEMENT /C

- Para completar o produto é necessário encomendar caixa de alimentação em separado.

02. Seleccionar caixa de alimentação

Encastrar - T52 Q200



135x135

HF

	CÓDIGO*
10,5W 10-42V 250mA HF	972010♣
14,7W 10-42V 350mA HF	972011♣

DALI

	CÓDIGO*
13W 09-52V 250mA DALI	972020♣
18,2W 09-52V 350mA DALI	972021♣

Saliente - T51 D120



HF

	CÓDIGO*
10W 30-42V 250mA HF	972030♣
15W 26-43V 350mA HF	972031♣

DALI

	CÓDIGO*
12W 03-45V 250mA DALI	972040♣
16W 03-45V 350mA DALI	972041♣

CAIXA DE ALIMENTAÇÃO

- A caixa de alimentação de encastrar T52 Q200 é classe II.
- A caixa de alimentação saliente T51 D120 é classe I.
- Fonte de alimentação incluída na caixa de alimentação.



*Substitua os símbolos para completar o código

Cor	♣
□ Branco	W
■ Preto	B
■ Rusty chain	R



Detalhes do produto



Efeito de luz com lente de 50°



Efeito de luz com lente de 80°



Caixas de alimentação



Orientável de parede

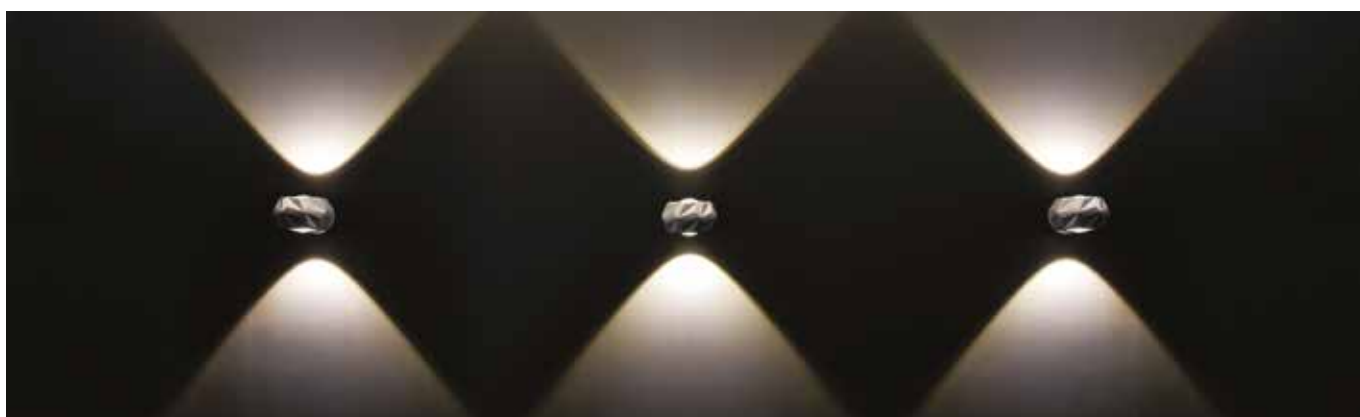
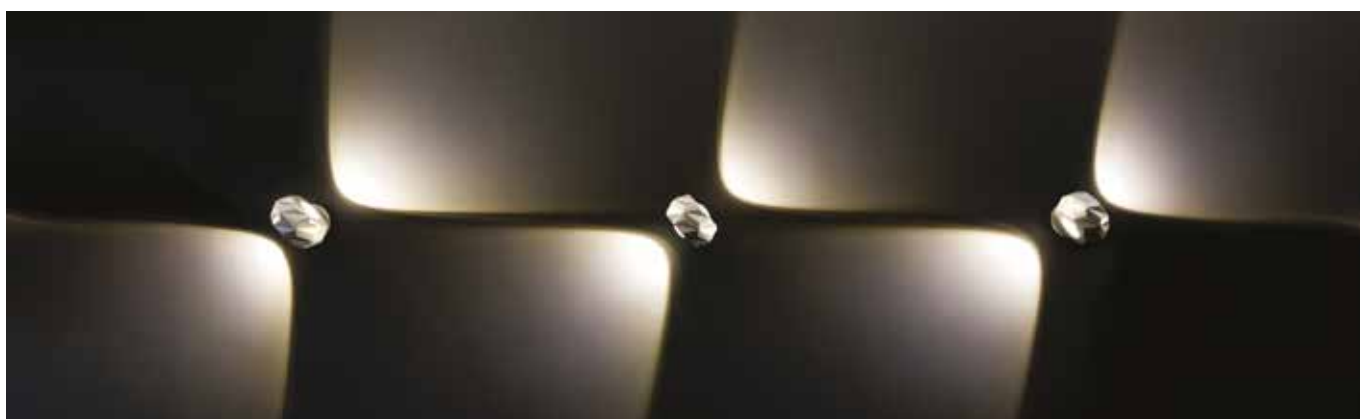

6th ELEMENT /W

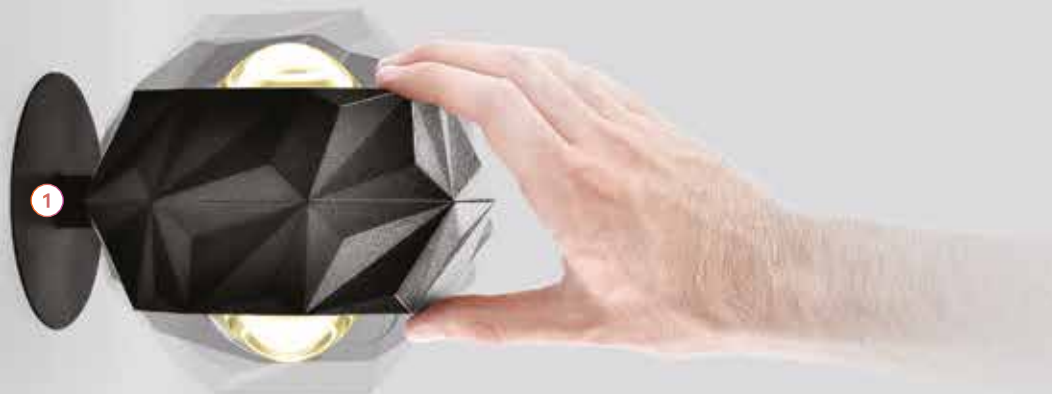

1. Rotação 355°

O produto permite uma rotação de 355° que proporciona versatilidade para iluminar objetos ou áreas específicas.



6th ELEMENT /W



Características do produto

Corpo

Alumínio injetado



Acabamento

Revestido a epóxi-poliéster



Sistema ótico

Lente



Fonte de luz

LED, RG1, CRI>90, MacAdam Step ≤3

Vida útil LED

50.000h @ L80, B10, Ta 25°C

Fonte de alimentação

Não incluída

01. Selecionar versão

6th ELEMENT /W

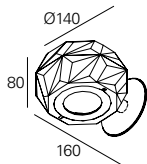

Lente de 50° | Direta / Indireta (50%/50%)

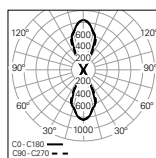

UGR	W	lm output	lm/W	mA	CÓDIGO*
≤10	17	2232	131	500	90279L0160▲0◆50

Lente de 80° | Direta / Indireta (50%/50%)

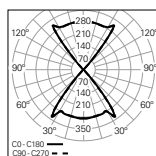

UGR	W	lm output	lm/W	mA	CÓDIGO*
≤19	17	2158	127	500	90279L0160▲0◆80

Lente de 50° | Direta

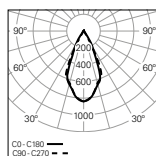

UGR	W	lm output	lm/W	mA	CÓDIGO*
≤13	9	1128	125	250	90330L0090▲0◆50
≤13	12	1512	126	350	90330L0160▲0◆50

Lente de 80° | Direta

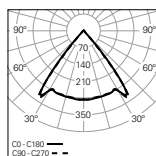

UGR	W	lm output	lm/W	mA	CÓDIGO*
≤25	9	1091	121	250	90330L0090▲0◆80
≤25	12	1428	119	350	90330L0160▲0◆80

6th ELEMENT /W

• Para completar o produto é necessário encomendar caixa de alimentação em separado.



*Substitua os símbolos para completar o código

Cor	◆
□ Branco	W
■ Preto	B
■ Rusty chain	R

Temp. de Cor	◆
3000K	B
4000K	A

02. Selecionar caixa de alimentação

Encastrar - T52 Q200

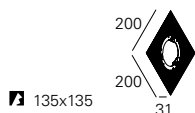

HF

	CÓDIGO*
10,5W 10-42V 250mA HF	972010♣
14,7W 10-42V 350mA HF	972011♣
21W 10-42V 500mA HF	972012♣

DALI

	CÓDIGO*
13W 09-52V 250mA DALI	972020♣
18,2W 09-52V 350mA DALI	972021♣
26W 09-52V 500mA DALI	972022♣

Saliente - T51 D120



HF

	CÓDIGO*
10W 30-42V 250mA HF	972030♣
15W 26-43V 350mA HF	972031♣
21W 30-42V 500mA HF	972032♣

DALI

	CÓDIGO*
12W 03-45V 250mA DALI	972040♣
16W 03-45V 350mA DALI	972041♣
20W 03-40V 500mA DALI	972042♣



*Substitua os símbolos para completar o código

Cor	♣
□ Branco	W
■ Preto	B
■ Rusty chain	R

CAIXA DE ALIMENTAÇÃO

- A caixa de alimentação de encastrar T52 Q200 é classe II.
- A caixa de alimentação saliente T51 D120 é classe I.
- Fonte de alimentação incluída na caixa de alimentação.



Detalhes do produto



Efeito de luz com lentes de 50°



Efeito de luz com lentes de 80°



Caixa de alimentação saliente





NOAH



NOAH
62



NOAH /D
68



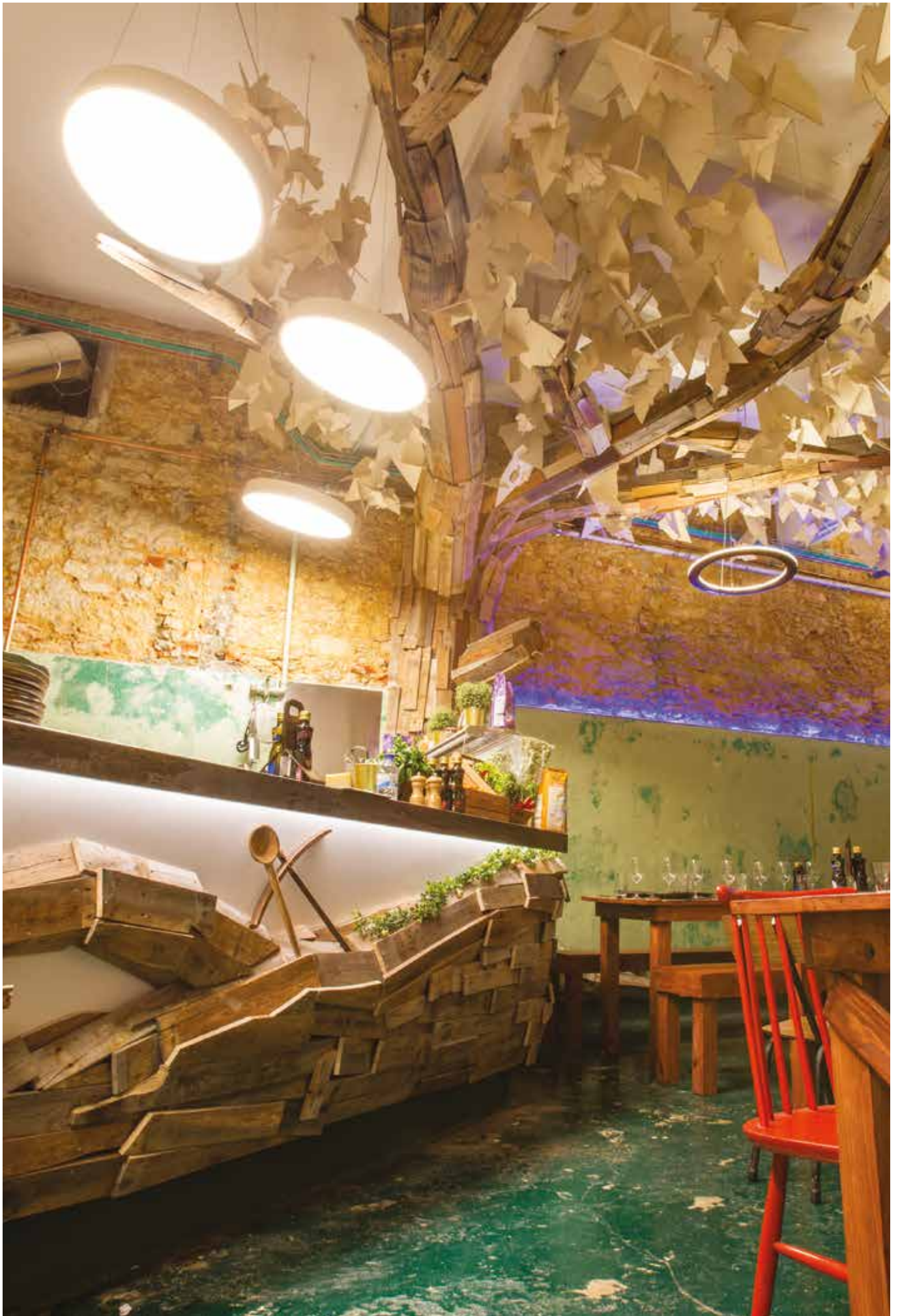



DAZ - Difusor opalino

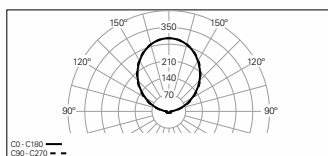

NOAH



Características do produto

Corpo

Madeira

Acabamento

Pau ferro brilho

Sistema ótico

DAZ - Difusor opalino

Cablagem

Cabo de alimentação transparente com
1500 mm incluído

Fonte de luz

LED, RG1, CRI>80, MacAdam Step ≤3

Vida útil LED

65.000h @ L90, B10, Ta 25°C

Fonte de alimentação

Não incluída



230V/50Hz



IP 40

650°C

01. Selecionar versão



NOAH



DAZ - Difusor opalino

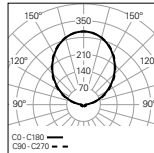

W
35

lm
output
5273

lm/W
135

CÓDIGO*
90061L0360J0♦00

*Substitua os símbolos para completar o código

Temp. de Cor ♦
3000K 3
4000K 0

NOAH

- Para completar o produto é necessário encomendar caixa de alimentação e suspensão em separado.

02. Seleccionar caixa de alimentação

Trimless

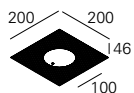

130x135

HF

Ø650 **CÓDIGO***
974810♣

DALI

Ø650 **CÓDIGO***
973010♣

BLUETOOTH

Ø650 **CÓDIGO***
972910♣

Saliente



HF

Ø650 **CÓDIGO***
974910♣

DALI

Ø650 **CÓDIGO***
973210♣

BLUETOOTH

Ø650 **CÓDIGO***
973110♣

CAIXA DE ALIMENTAÇÃO

• Fonte de alimentação incluída na caixa de alimentação.

03. Seleccionar opções

OPÇÕES

Código

Suspensão

S10 L1500 mm (x3) 9111001



*Substitua os símbolos para completar o código

Cor

□ Branco W

■ Preto B



Detalhes do produto



Acabamento em pau ferro brilho



Aplicação suspensa



Difusor DAZ



Pormenor acabamento



Caixa de alimentação trimless



Caixa de alimentação saliente



Orientável de mesa





1. Inclinação 20°

O produto é ajustável e permite uma inclinação de 20° em todas as direções, que proporciona versatilidade para direcionar a luz ao seu desejo.

2. Botão TouchDIM

O botão TouchDIM permite ligar ou desligar o produto e ainda regular a intensidade da luz de forma fácil e intuitiva.



NOAH /D



Características do produto

Corpo

Base em aço
Parte superior em madeira

Acabamento

Base revestida a epóxi-poliéster preto
Parte superior em Pau Ferro brilho

Sistema ótico

DAZ - Difusor opalino

Cablagem

Cabo de alimentação preto com 1500 mm
e ficha elétrica tipo F incluída

Fonte de luz

LED, RG1, CRI>90, MacAdam Step ≤3

Vida útil LED

60.000h @ L80, B10, Ta 25°C

Fonte de alimentação

Transformador de 24V incluído



01. Seleccionar versão



NOAH / D

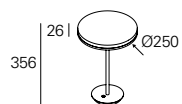

DAZ - Difusor opalino

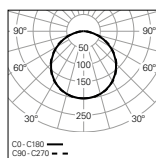

W
5

Im
output
307

Im/W
61

CÓDIGO*
90306L009HJ0♦00

*Substitua os símbolos para completar o código

Temp. de Cor ♦
2700K 2
4000K 0

NOAH / D

- O produto standard é fornecido com botão TouchDIM.



Detalhes do produto



Acabamento em pau ferro brilho



Botão TouchDIM



Ajustável



Pormenor acabamento



Ficha elétrica tipo F

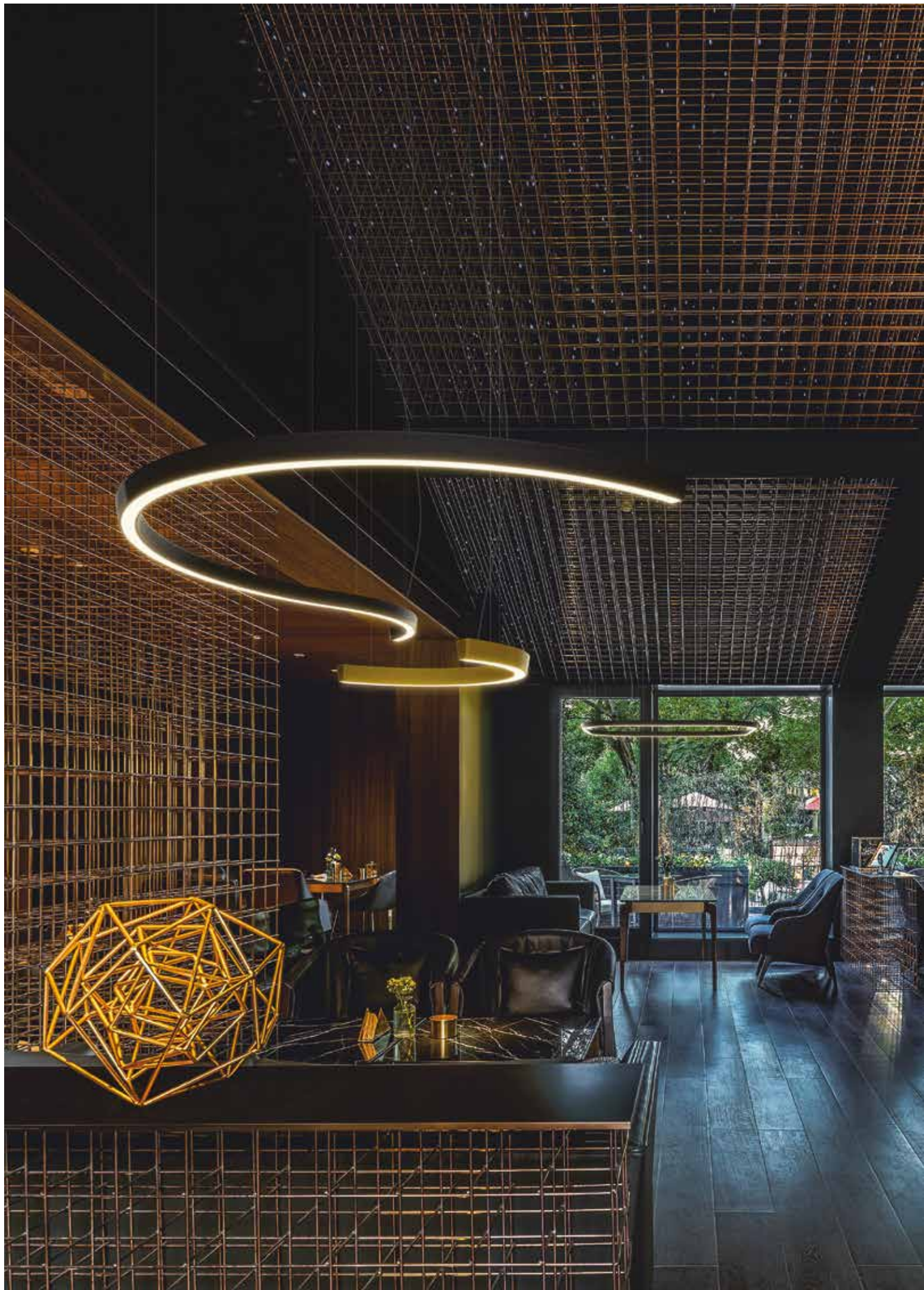

CONCEPT 35



CONCEPT S 35 / E
90



CONCEPT S 35
94



CONCEPT S 35 D/I
98



CONCEPT O 35 / E
104



CONCEPT O 35
106



CONCEPT O 35 D/I
110



CONCEPT Sq 35
114



CONCEPT Sq 35 D/I
118



CONCEPT D 35
122



CONCEPT D 35 D/I
126



Tipos de aplicação



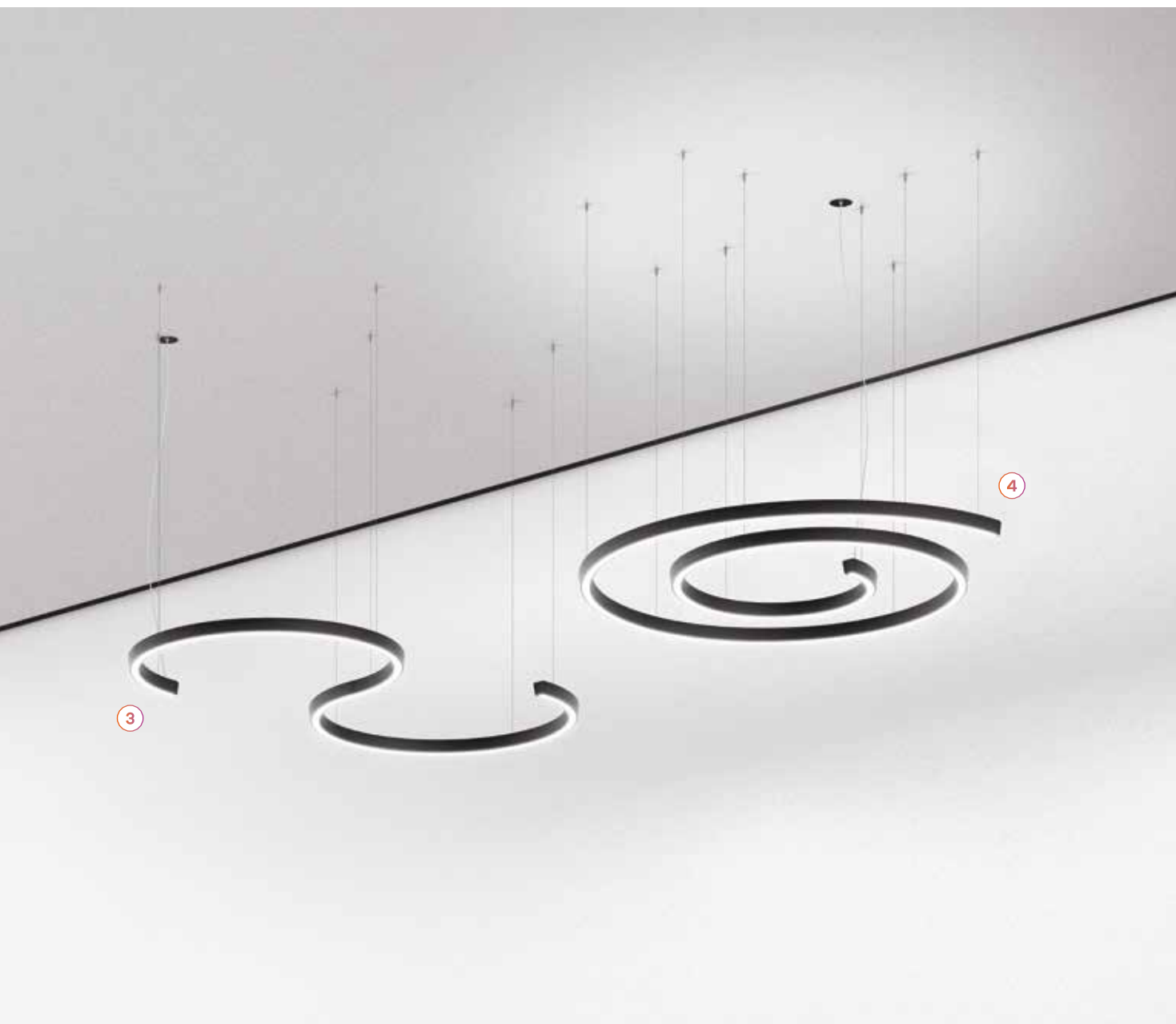

1. Encastrar

2. Saliente

3. Suspensa
Direta

4. Suspensa
Direta / Indireta

5. Parede

Um visual moderno para o seu espaço

1/16 (22,5°)



1/8 (45°)



1/4 (90°)



1/2 (180°)





Sq



1/1 (360°)



LINEA

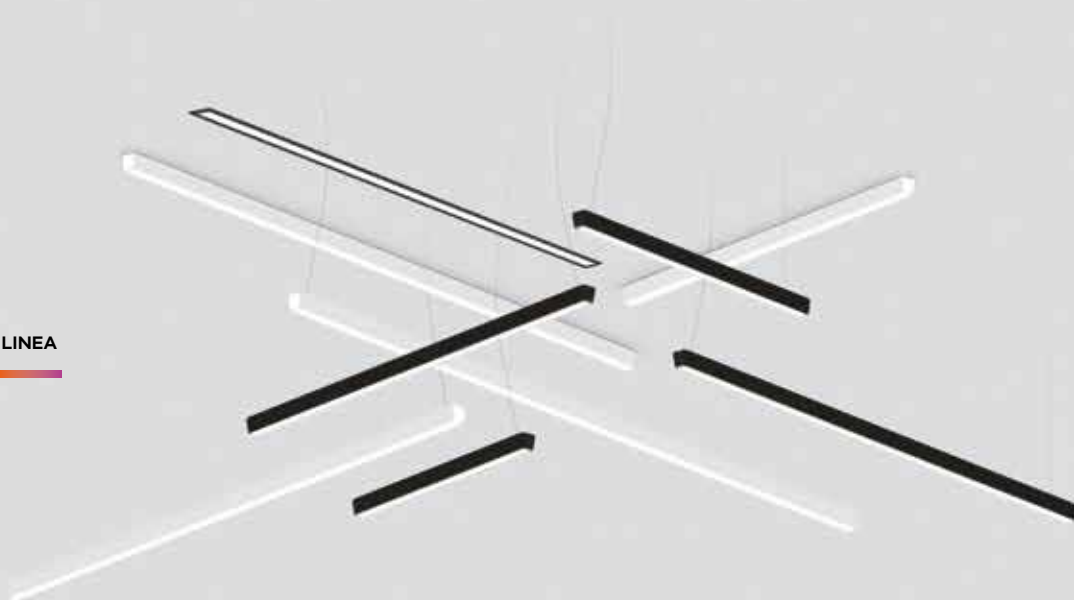

Como criar espaços através da luz

Exemplo 1



Exemplo 2



Exemplo 3



Exemplo 4

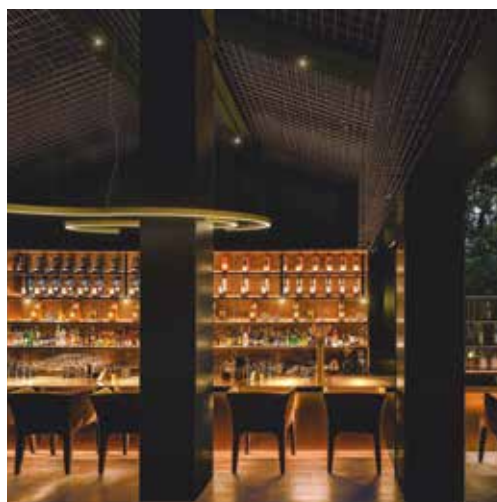



1. bFLEX

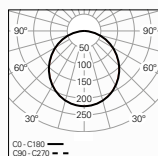

Minimalismo e tecnologia

1. Corpo

Perfil de alumínio soldado sem marcas visíveis, disponível em 12 cores.

2. LED

SDCM MacAdam ≤ 3 , temperatura de cor 3000K / 4000K, CRI > 80 e vida útil de 60.000h L90 B10.

3. bFLEX

Difusor de alta tecnologia com versão opalina (bFLEX) que garante uma luz suave e uniforme sem pontos visíveis. Difusor especial disponível em rolo único de 5000, 15000 ou 30000 mm.



4. Topo

Topos de alumínio injetado, sem saída de luz e sem parafusos visíveis. Disponíveis na cor do produto.

5. HPR

Refletor interno de alta performance para garantir elevada eficiência e uma luz suave e uniforme.

6. Luz indireta

Versão direta / indireta com 80% / 20% de proporção de luz e difusor opalino para uniformidade da luz no teto.

7. Fonte de alimentação DALI ou HF

SwitchDIM sob consulta.

8. Suspensão e cabo de alimentação

Suspensões e cabo de alimentação disponíveis com comprimento de 1500, 3000 ou 6000 mm.

9. Caixa de alimentação

Caixas de alimentação nas versões de encastrar ou saliente. Disponíveis na cor branca ou preta.



10. Kit de união

As extremidades dos módulos são fabricadas de modo a que não exista saída de luz, quer se trate de uma versão curva ou reta.

O kit do sistema de conexão inclui um conector rápido para a parte elétrica que garante uma rápida e fácil instalação.

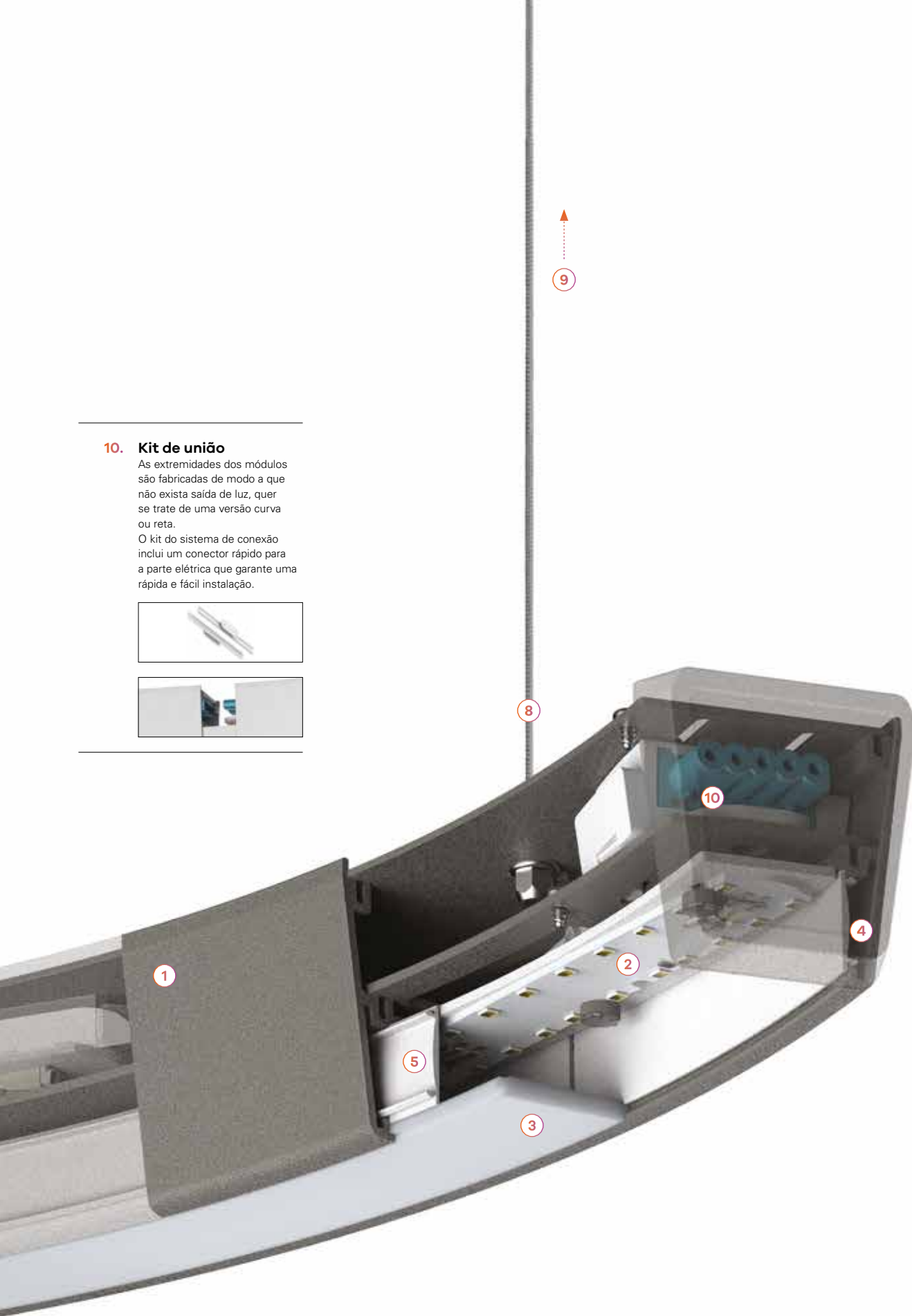

Composição de elementos estruturais

Como estruturar uma linha

(Vista de cima)

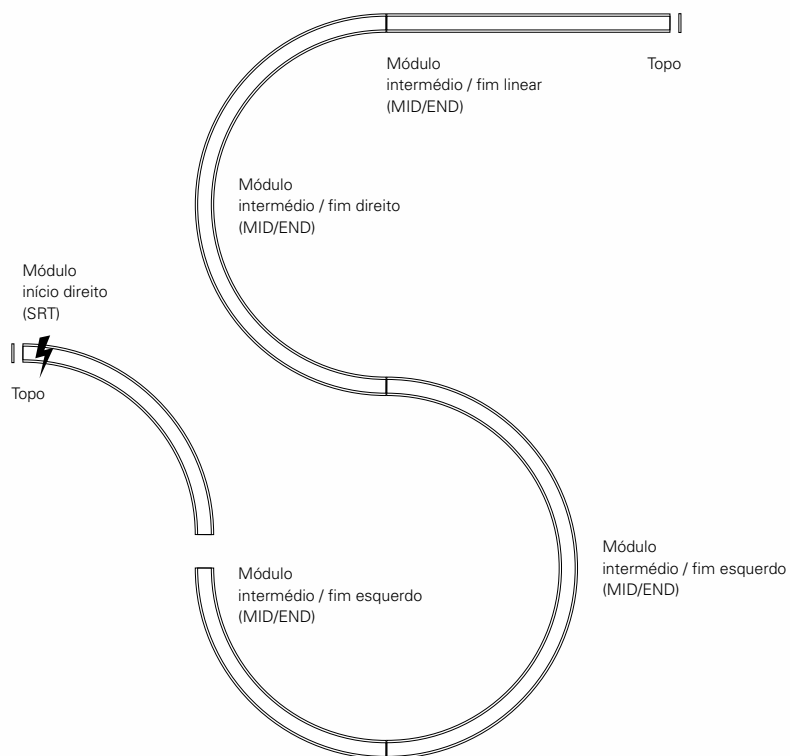

Módulos disponíveis

(Vista de cima)

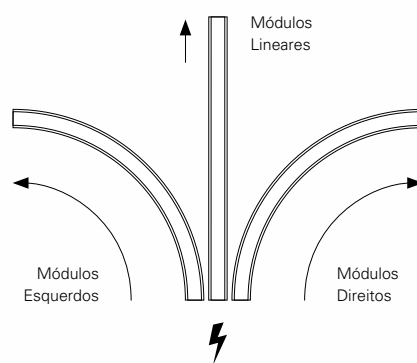

1. Topos

2. Módulos LED

2.1 Módulo início (SRT).

2.2 Módulo intermédio / fim (MID/END).

3. Kit de união

4. Caixas de alimentação

5. Cabo de alimentação

6. Suspensão

Encastrar

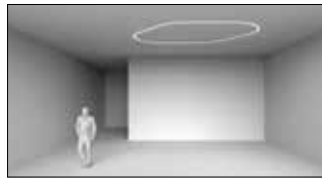

Suspensa, saliente ou parede

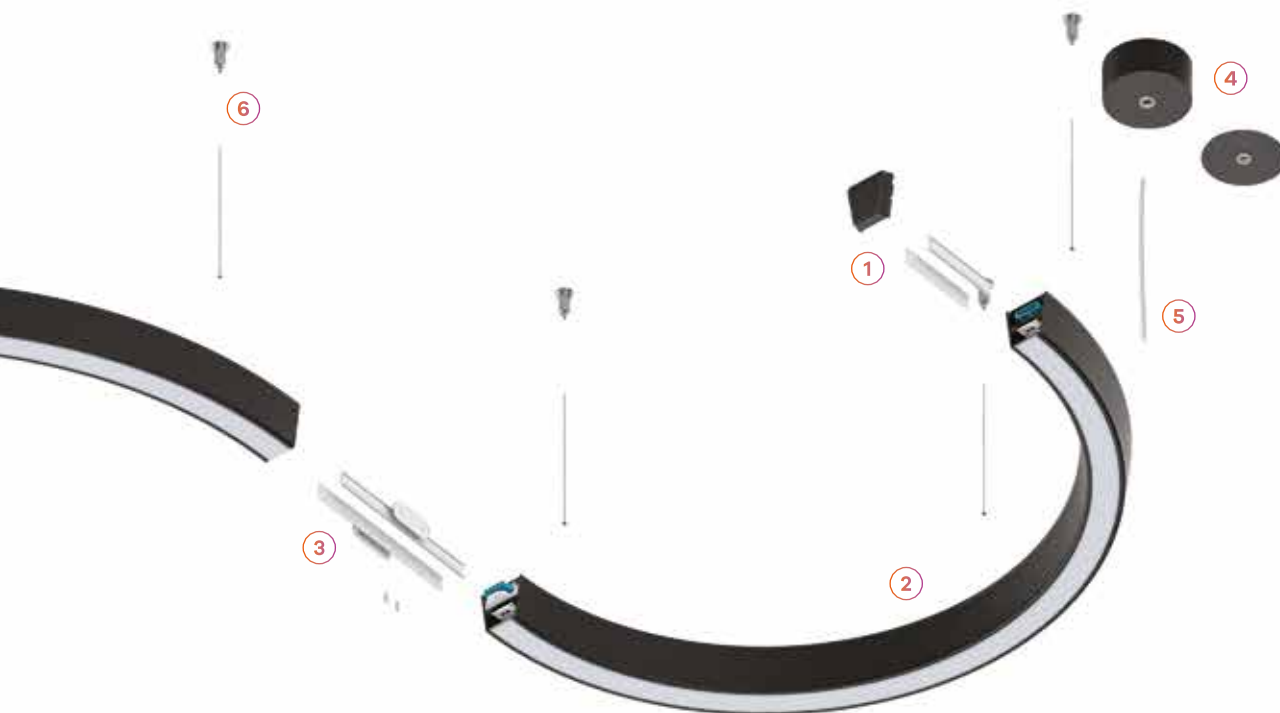
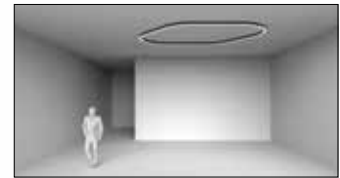

Uma gama de infinitas possibilidades

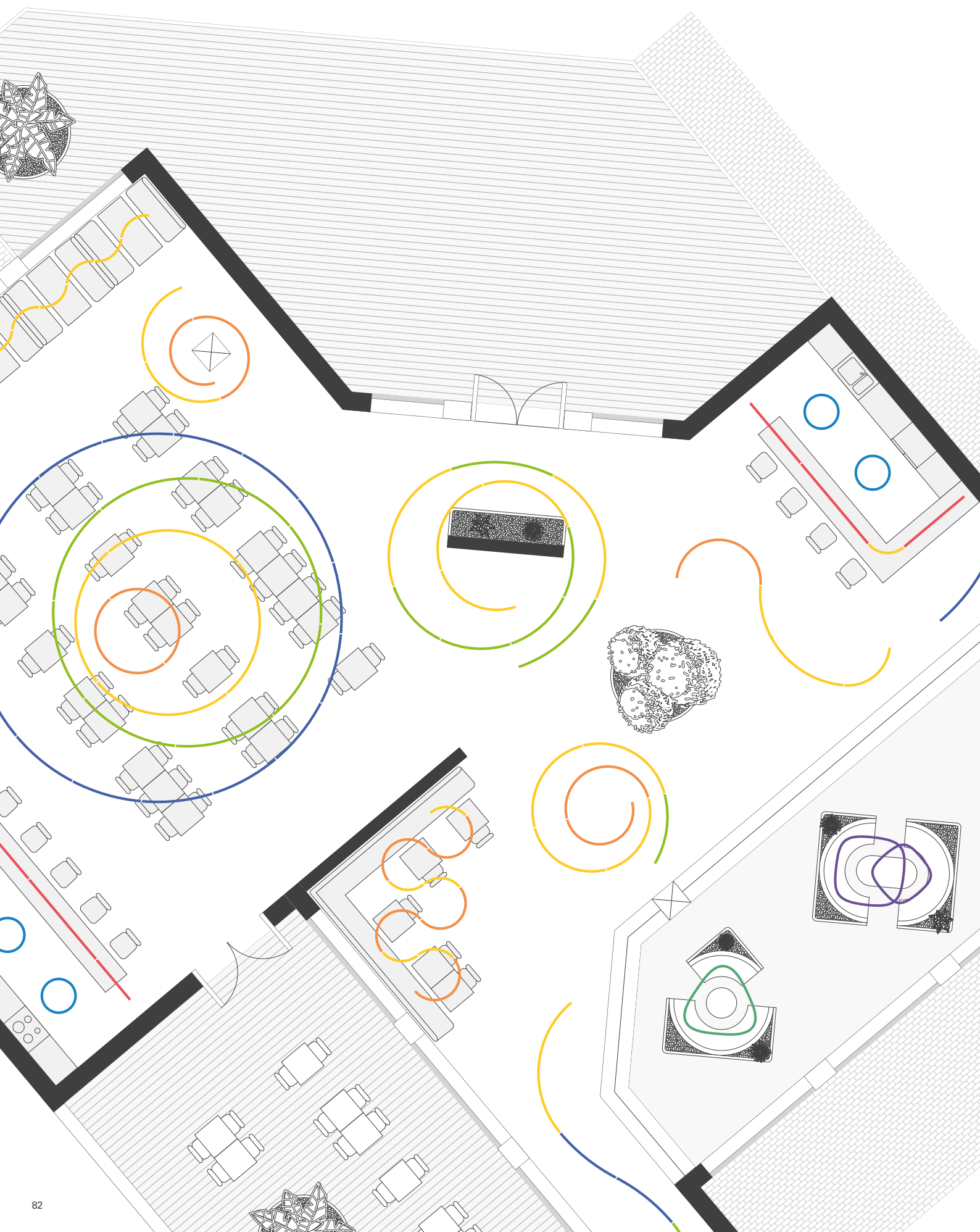

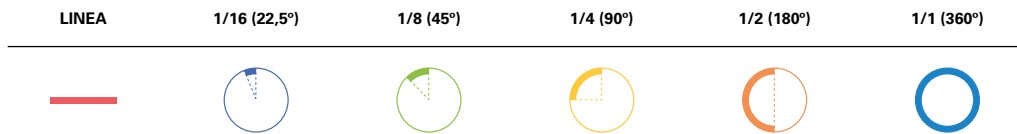

≈843 mm	•				
≈1124 mm	•				
≈1405 mm	•				
≈1686 mm	•				
≈1967 mm	•				
≈2248 mm	•				
≈2529 mm	•				
≈2810 mm	•				
≈Ø455 mm					•
≈Ø777 mm				•	•
≈Ø1136 mm			•	•	•
≈Ø1494 mm			•	•	•
≈Ø1853 mm		•	•	•	
≈Ø2569 mm		•	•		
≈Ø2926 mm		•	•		
≈Ø4000 mm		•	•		
≈Ø5789 mm		•			
≈Ø7936 mm		•			



≈1126 mm		•
≈1187 mm	•	
≈1441 mm		•
≈1465 mm	•	

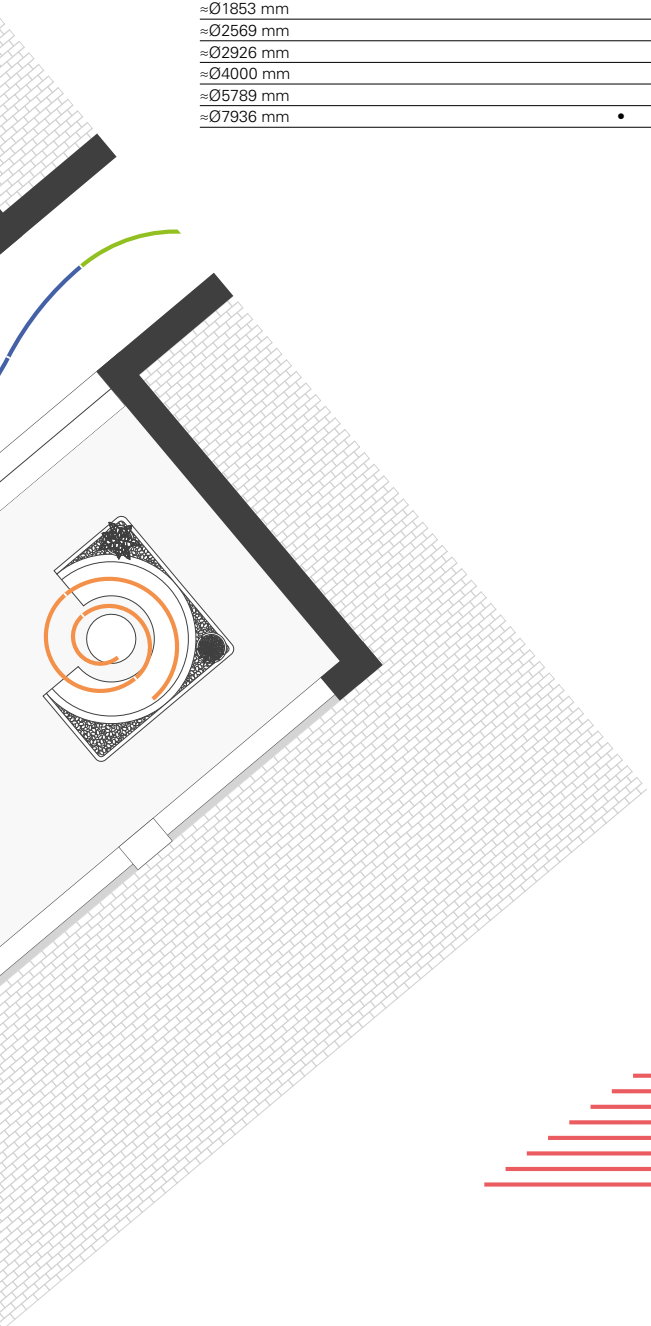

Módulos disponíveis



Escala 1:100 1000 mm

Defina a sua cor

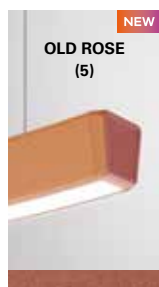
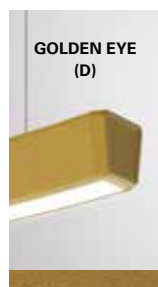
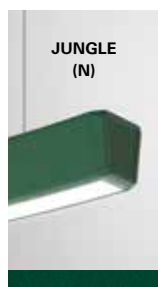
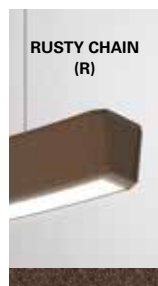
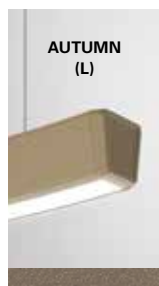
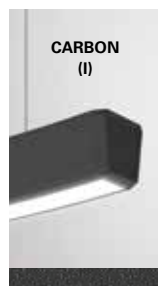
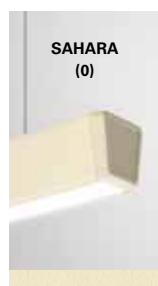
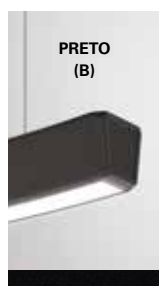
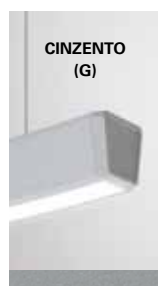



Design e elegância



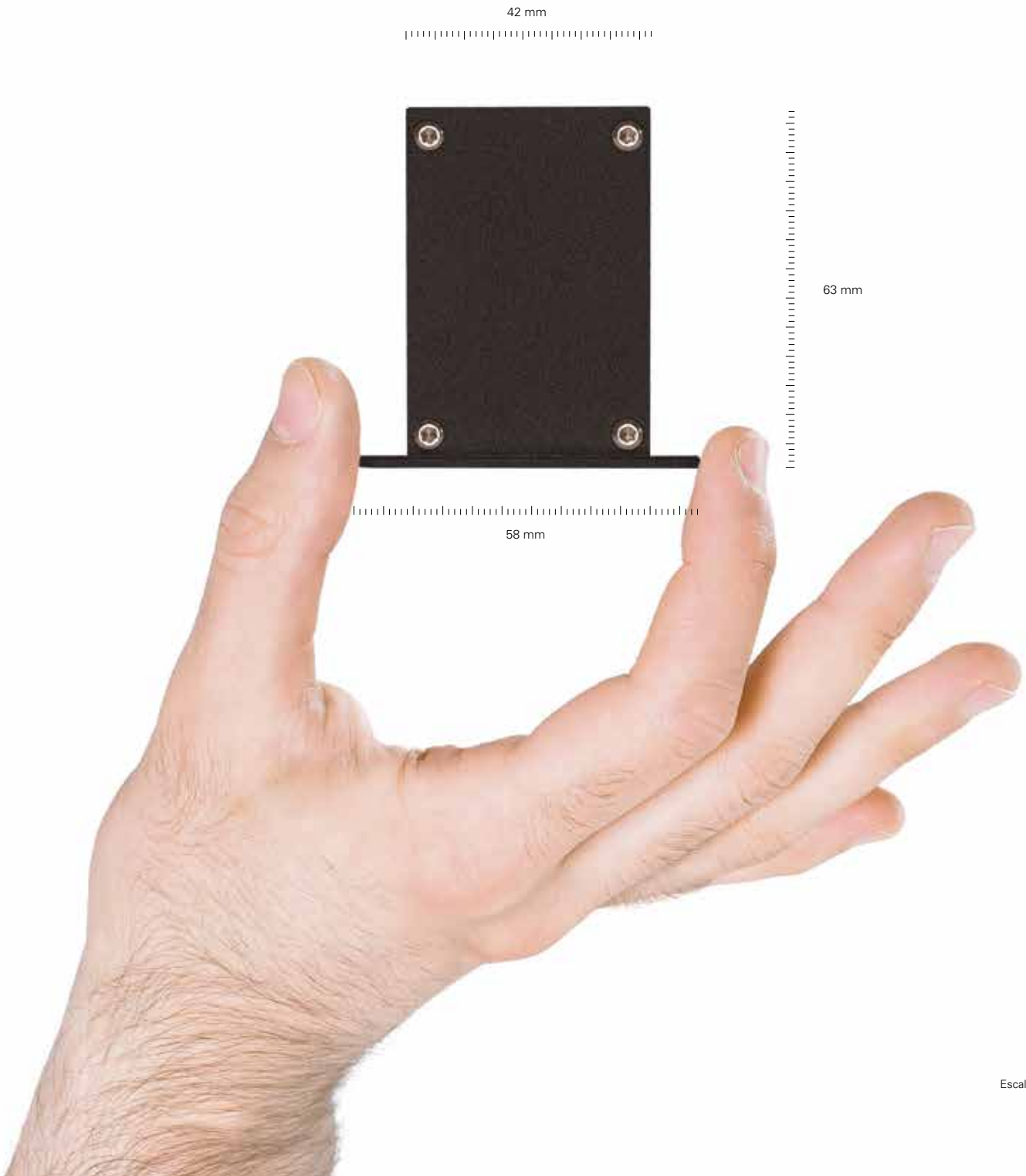

Crie você mesmo!



Configurador

Descubra o nosso configurador da gama CONCEPT 35 e crie o seu próprio design de iluminação de forma mais rápida e inteligente!

configurator.indelaguegroup.com



CONCEPT S 35 /E



Características do produto

Corpo

Alumínio



Acabamento

Revestido a epóxi-poliéster

230V/50Hz

Sistema ótico

bFLEX - Difusor opalino não incluído



Cablagem

Cablagem interna de linha contínua incluída



Fonte de luz

LED, RG1, CRI>80, MacAdam Step ≤3

Vida útil LED

70.000h @ L90, B10, Ta 25°C

Fonte de alimentação

Driver LED 220-240V-50/60Hz incluído

Espessura do teto

Para tetos entre 1-25 mm

01. Selecionar módulo



MÓDULO CURVO

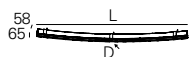

1/16 (22,5°) | bFLEX - Difusor opalino (Não incluído)

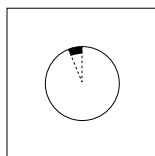

W	Im output	Im/W	Lmm	Dmm	CÓDIGO*
49	4539	93	1549	Ø7939	90710▲011▼▲0♣♣

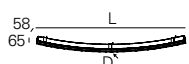

1/8 (45°) | bFLEX - Difusor opalino (Não incluído)

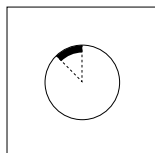

W	Im output	Im/W	Lmm	Dmm	CÓDIGO*
24	2063	86	710	Ø1856	90711▲005▼▲0♣♣
32	2889	90	984	Ø2572	90711▲007▼▲0♣♣
36	3301	92	1121	Ø2929	90711▲008▼▲0♣♣
49	4539	93	1532	Ø4003	90711▲011▼▲0♣♣
68	6602	97	2217	Ø5792	90711▲016▼▲0♣♣

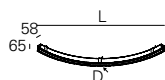

1/4 (90°) | bFLEX - Difusor opalino (Não incluído)

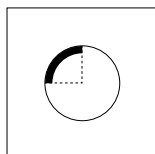

W	Im output	Im/W	Lmm	Dmm	CÓDIGO*
28	2476	88	805	Ø1139	90712▲006▼▲0♣♣
36	3301	92	1059	Ø1497	90712▲008▼▲0♣♣
44	4127	94	1312	Ø1856	90712▲010▼▲0♣♣
61	5777	95	1818	Ø2572	90712▲014▼▲0♣♣
68	6602	97	2071	Ø2929	90712▲016▼▲0♣♣
90	9078	101	2831	Ø4003	90712▲022▼▲0♣♣

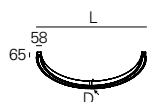

1/2 (180°) | bFLEX - Difusor opalino (Não incluído)

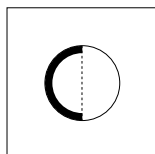

W	Im output	Im/W	Lmm	Dmm	CÓDIGO*
36	3301	92	780	Ø780	90713▲008▼▲0♣♣
53	4952	93	1139	Ø1139	90713▲012▼▲0♣♣
68	6602	97	1497	Ø1497	90713▲016▼▲0♣♣
83	8253	99	1856	Ø1856	90713▲020▼▲0♣♣

*Substitua os símbolos para completar o código

Orientação	▲
LEFT	L
RIGHT	R

Fonte de alimentação	▼
HF	E
DALI	H

Cor ¹	♣
□ Branco	W
■ Cinzento	G
■ Preto	B
■ Sahara	0
■ Mist	1
■ Carbon	I
■ Autumn	L
■ Rusty chain	R
■ Jungle	N
■ Golden eye	D
■ Old rose	5
■ Copper	7

Temp. de Cor	♦
3000K	3
4000K	0

Módulo	♣
SRT	49
MID/END	98

MÓDULO LINEAR

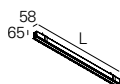

LINEA | bFLEX - Difusor opalino (Não incluído)

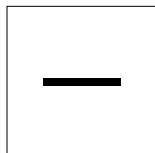

W	Im output	Im/W	Lmm	CÓDIGO*
28	2476	88	843	90709L006▼▲0♣♣
36	3301	92	1124	90709L008▼▲0♣♣
44	4127	94	1405	90709L010▼▲0♣♣
53	4952	93	1686	90709L012▼▲0♣♣
61	5777	95	1967	90709L014▼▲0♣♣
68	6602	97	2248	90709L016▼▲0♣♣
76	7428	98	2529	90709L018▼▲0♣♣
83	8253	99	2810	90709L020▼▲0♣♣

MÓDULO CURVO | MÓDULO LINEAR

- Para completar o produto individual é necessário encomendar difusor bFLEX e start kit em separado.
- Para completar a linha é necessário encomendar difusor bFLEX, start kit e kit de união em separado.
- Dimensões não incluem start kit. Adicione 6 mm ao comprimento de corte para completar a dimensão de encaixe da linha.
- Para obter as dimensões de corte, consulte as instruções de montagem do produto ou o nosso site.

02. Selecionar opções

OPÇÕES	Código*
Difusor bFLEX	
L5000 mm	985705
L15000 mm	985715
L30000 mm	985730
SwitchDIM	
• Sob consulta.	
Start kit - topo início/fim 923010♣	
• Dois topos e parafusos incluídos.	
Kit de união (x1) 932010	
• Parafusos incluídos.	
Kit de união VRT 90° (x1) 932020	
• Parafusos incluídos.	
Cabo de segurança em aço	
L1500 mm	955000
Kit marcação de teto	
• Sob consulta.	



*Substitua os símbolos para completar o código

Cor ¹	♣
□ Branco	W
■ Cinzento	G
■ Preto	B
■ Sahara	0
■ Mist	1
■ Carbon	I
■ Autumn	L
■ Rusty chain	R
■ Jungle	N
■ Golden eye	D
■ Old rose	5
■ Copper	7



Detalhes do produto



Topo

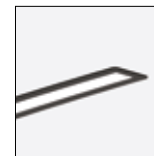

Aplicação de encastrar



Difusor contínuo



Difusor bFLEX



Difusor aplicado



CONCEPT S 35



Características do produto

Corpo

Alumínio

Acabamento

Revestido a epóxi-poliéster

Sistema ótico

bFLEX - Difusor opalino não incluído

Cablagem

Cablagem interna de linha contínua incluída

Fonte de luz

LED, RG1, CRI>80, MacAdam Step ≤3

Vida útil LED

70.000h @ L90, B10, Ta 25°C

Fonte de alimentação

Driver LED 220-240V-50/60Hz incluído



230V/50Hz



IP 40



01. Seleccionar módulo



MÓDULO CURVO

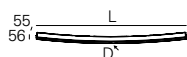

1/16 (22,5°) | bFLEX - Difusor opalino (Não incluído)

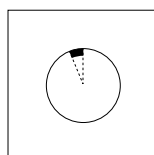

W	Im output	Im/W	Lmm	Dmm	CÓDIGO*
49	4539	93	1548	Ø7936	90543▲011▼▲0♣♣

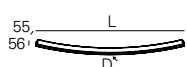

1/8 (45°) | bFLEX - Difusor opalino (Não incluído)

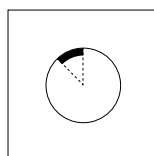

W	Im output	Im/W	Lmm	Dmm	CÓDIGO*
24	2063	86	709	Ø1853	90544▲005▼▲0♣♣
32	2889	90	983	Ø2569	90544▲007▼▲0♣♣
36	3301	92	1120	Ø2926	90544▲008▼▲0♣♣
49	4539	93	1531	Ø4000	90544▲011▼▲0♣♣
68	6602	97	2215	Ø5789	90544▲016▼▲0♣♣



1/4 (90°) | bFLEX - Difusor opalino (Não incluído)

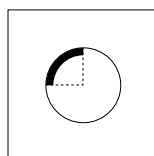

W	Im output	Im/W	Lmm	Dmm	CÓDIGO*
28	2476	88	803	Ø1136	90545▲006▼▲0♣♣
36	3301	92	1057	Ø1494	90545▲008▼▲0♣♣
44	4127	94	1310	Ø1853	90545▲010▼▲0♣♣
61	5777	95	1816	Ø2569	90545▲014▼▲0♣♣
68	6602	97	2069	Ø2926	90545▲016▼▲0♣♣
90	9078	101	2828	Ø4000	90545▲022▼▲0♣♣

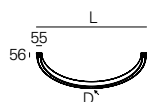

1/2 (180°) | bFLEX - Difusor opalino (Não incluído)

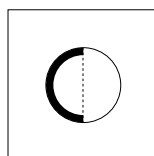

W	Im output	Im/W	Lmm	Dmm	CÓDIGO*
36	3301	92	777	Ø777	90546▲008▼▲0♣♣
53	4952	93	1136	Ø1136	90546▲012▼▲0♣♣
68	6602	97	1494	Ø1494	90546▲016▼▲0♣♣
83	8253	99	1853	Ø1853	90546▲020▼▲0♣♣

*Substitua os símbolos para completar o código

Orientação	▲
LEFT	L
RIGHT	R

Fonte de alimentação	▼
HF	E
DALI	H

Cor ¹	♣
□ Branco	W
■ Cinzento	G
■ Preto	B
■ Sahara	0
■ Mist	1
■ Carbon	I
■ Autumn	L
■ Rusty chain	R
■ Jungle	N
■ Golden eye	D
■ Old rose	5
■ Copper	7

Temp. de Cor	♦
3000K	3
4000K	0

Módulo	♣
SRT	49
MID/END	98

MÓDULO LINEAR

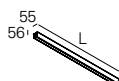

LINEA | bFLEX - Difusor opalino (Não incluído)

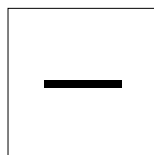

W	Im output	Im/W	Lmm	CÓDIGO*
28	2476	88	843	90541L006▼▲0♣♣
36	3301	92	1124	90541L008▼▲0♣♣
44	4127	94	1405	90541L010▼▲0♣♣
53	4952	93	1686	90541L012▼▲0♣♣
61	5777	95	1967	90541L014▼▲0♣♣
68	6602	97	2248	90541L016▼▲0♣♣
76	7428	98	2529	90541L018▼▲0♣♣
83	8253	99	2810	90541L020▼▲0♣♣

MÓDULO CURVO | MÓDULO LINEAR

- Para completar o produto individual é necessário encomendar difusor bFLEX e start kit em separado.
- Para completar a linha é necessário encomendar difusor bFLEX, start kit e kit de união em separado.
- Para versão suspensa é necessário encomendar suspensão, cabo e caixa de alimentação em separado.
- Dimensões não incluem start kit. Adicione 26 mm ao comprimento para completar a linha.
- Para auxiliar na configuração do produto, por favor consulte CONFIGURATOR.INDELAGUEGROUP.COM.

02. Selecionar opções

OPÇÕES	Código*
Difusor bFLEX	
L5000 mm	985705
L15000 mm	985715
L30000 mm	985730
SwitchDIM	
• Sob consulta.	
Start kit - topo início/fim	
• Dois topos incluídos.	923000♣
Kit de união (x1)	
• Parafusos incluídos.	932000
Suspensão	
• Para todas as versões curvas e versões linha L1967, L2248, L2529, L2810 mm:	
S11 L1500 mm (x3)	9129031
S11 L3000 mm (x3)	9129032
S11 L6000 mm (x3)	9129033
• Para versões Linha L843, L1124, L1405, L1686 mm:	
S11 L1500 mm (x2)	9129021
S11 L3000 mm (x2)	9129022
S11 L6000 mm (x2)	9129023
Cabo de alimentação transparente	
L1500 mm - 3 x 1,5 mm ²	940300
L1500 mm - 5 x 1,5 mm ²	940000
L3000 mm - 3 x 1,5 mm ²	940301
L3000 mm - 5 x 1,5 mm ²	940001
L6000 mm - 3 x 1,5 mm ²	940302
L6000 mm - 5 x 1,5 mm ²	940002
Caixa de alimentação circular ¹	
Saliente T24 D95 45 Ø95	978600♣
Encastrar T5 D90 Ø70 33 Ø90	971300♣
Kit marcação de teto	
• Sob consulta.	



*Substitua os símbolos para completar o código

Cor ¹²	♣
□ Branco	W
■ Cinzento	G
■ Preto	B
■ Sahara	0
■ Mist	1
■ Carbon	I
■ Autumn	L
■ Rusty chain	R
■ Jungle	N
■ Golden eye	D
■ Old rose	5
■ Copper	7



Detalhes do produto



Topos sem parafusos visíveis



Aplicação saliente



Aplicação suspensa



Conexão rápida



Difusor contínuo



Difusor bFLEX



Difusor aplicado



Start kit



Kit de união



Caixas de alimentação



CONCEPT S 35 D/I



Características do produto

Corpo

Alumínio

Acabamento

Revestido a epóxi-poliéster

Sistema ótico

bFLEX - Difusor opalino não incluído

Cablagem

Cablagem interna de linha contínua incluída

Fonte de luz

LED, RG1, CRI>80, MacAdam Step ≤ 3

Vida útil LED

70.000h @ L90, B10, Ta 25°C

Fonte de alimentação

Driver LED 220-240V-50/60Hz incluído



230V/50Hz



IP 40

bFLEX
960°C

01. Selecionar módulo



MÓDULO CURVO

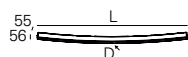

1/16 (22,5°) | bFLEX - Difusor opalino (Não incluído) (80%/20%)

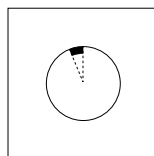

W	lm output	lm/W	Lmm	Dmm	CÓDIGO*
61	5777	95	1548	Ø7936	90547▲011▼▲0◆♣

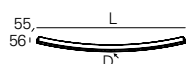

1/8 (45°) | bFLEX - Difusor opalino (Não incluído) (80%/20%)

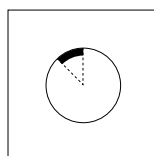

W	lm output	lm/W	Lmm	Dmm	CÓDIGO*
44	4127	94	1120	Ø2926	90548▲008▼▲0◆♣
61	5777	95	1531	Ø4000	90548▲011▼▲0◆♣
83	8253	99	2215	Ø5789	90548▲016▼▲0◆♣



1/4 (90°) | bFLEX - Difusor opalino (Não incluído) (80%/20%)

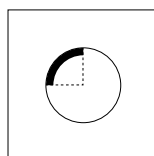

W	lm output	lm/W	Lmm	Dmm	CÓDIGO*
44	4127	94	1057	Ø1494	90549▲008▼▲0◆♣
57	5364	94	1310	Ø1853	90549▲010▼▲0◆♣
76	7428	98	1816	Ø2568	90549▲014▼▲0◆♣
83	8253	99	2069	Ø2926	90549▲016▼▲0◆♣
122	11554	95	2828	Ø4000	90549▲022▼▲0◆♣

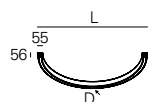

1/2 (180°) | bFLEX - Difusor opalino (Não incluído) (80%/20%)

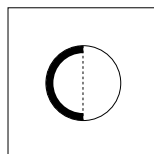

W	lm output	lm/W	Lmm	Dmm	CÓDIGO*
44	4127	94	777	Ø777	90550▲008▼▲0◆♣
64	6190	97	1136	Ø1136	90550▲012▼▲0◆♣
83	8253	99	1494	Ø1494	90550▲016▼▲0◆♣
110	10316	94	1853	Ø1853	90550▲020▼▲0◆♣

*Substitua os símbolos para completar o código

Orientação	▲
LEFT	L
RIGHT	R

Fonte de alimentação	▼
HF	E
DALI	H

Cor ¹	♣
□ Branco	W
■ Cinzento	G
■ Preto	B
■ Sahara	0
■ Mist	1
■ Carbon	I
■ Autumn	L
■ Rusty chain	R
■ Jungle	N
■ Golden eye	D
■ Old rose	5
■ Copper	7

Temp. de Cor	◆
3000K	3
4000K	0

Módulo	♣
SRT	49
MID/END	98

MÓDULO LINEAR

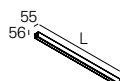

LINEA | bFLEX - Difusor opalino (Não incluído) (80%/20%)

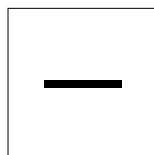



W	lm output	lm/W	Lmm	CÓDIGO*
44	4127	94	1124	90542L008▼▲0◆♣
57	5364	94	1405	90542L010▼▲0◆♣
64	6190	97	1686	90542L012▼▲0◆♣
76	7428	98	1967	90542L014▼▲0◆♣
83	8253	99	2248	90542L016▼▲0◆♣
94	9491	101	2529	90542L018▼▲0◆♣
110	10316	94	2810	90542L020▼▲0◆♣

MÓDULO CURVO | MÓDULO LINEAR

- Para completar o produto individual é necessário encomendar difusor bFLEX, start kit, suspensão, cabo e caixa de alimentação em separado.
- Para completar a linha é necessário encomendar difusor bFLEX, start kit, kit de união, suspensão, cabo e caixa de alimentação em separado.
- Dimensões não incluem start kit. Adicione 26 mm ao comprimento para completar a linha.
- De forma a garantir uma total uniformidade de luz no teto, a instalação deverá ser feita a uma distância mínima de 500 mm.
- Para auxiliar na configuração do produto, por favor consulte CONFIGURATOR.INDELAGUEGROUP.COM.

02. Selecionar opções

OPÇÕES	Código*
Difusor bFLEX	
L5000 mm	985705
L15000 mm	985715
L30000 mm	985730
SwitchDIM	
• Sob consulta.	
Start kit - topo início/fim	
• Dois topos incluídos.	55 923000♣ 56 13 35
Kit de união (x1)	
• Parafusos incluídos.	932000
Suspensão	
• Para todas as versões curvas e versões línea L1967, L2248, L2529, L2810 mm:	
S11 L1500 mm (x3)	9129031
S11 L3000 mm (x3)	9129032
S11 L6000 mm (x3)	9129033
• Para versões Línea L843, L1124, L1405, L1686 mm:	
S11 L1500 mm (x2)	9129021
S11 L3000 mm (x2)	9129022
S11 L6000 mm (x2)	9129023
Cabo de alimentação transparente	
L1500 mm - 3 x 1,5 mm ²	940300
L1500 mm - 5 x 1,5 mm ²	940000
L3000 mm - 3 x 1,5 mm ²	940301
L3000 mm - 5 x 1,5 mm ²	940001
L6000 mm - 3 x 1,5 mm ²	940302
L6000 mm - 5 x 1,5 mm ²	940002
Caixa de alimentação circular¹	
Saliente T24 D95	45  Ø95 978600♣
Encastrar T5 D90	 Ø70 33  Ø90 971300♣
Kit marcação de teto	
• Sob consulta.	



*Substitua os símbolos para completar o código

Cor ^{1,2}	♣
<input type="checkbox"/> Branco	W
<input type="checkbox"/> Cinzento	G
<input type="checkbox"/> Preto	B
<input type="checkbox"/> Sahara	0
<input type="checkbox"/> Mist	1
<input type="checkbox"/> Carbon	I
<input type="checkbox"/> Autumn	L
<input type="checkbox"/> Rusty chain	R
<input type="checkbox"/> Jungle	N
<input type="checkbox"/> Golden eye	D
<input type="checkbox"/> Old rose	5
<input type="checkbox"/> Copper	7



Detalhes do produto



Topos sem parafusos visíveis



Aplicação suspensa



Conexão rápida



Difusor contínuo



Luz indireta

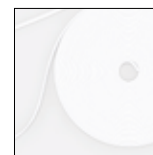

Difusor bFLEX



Difusor aplicado



Start kit



Kit de união



Caixas de alimentação

¹ As caixas de alimentação apenas estão disponíveis na cor branca ou preta.

² Ver página 84.



Composição de elementos estruturais



Módulos disponíveis

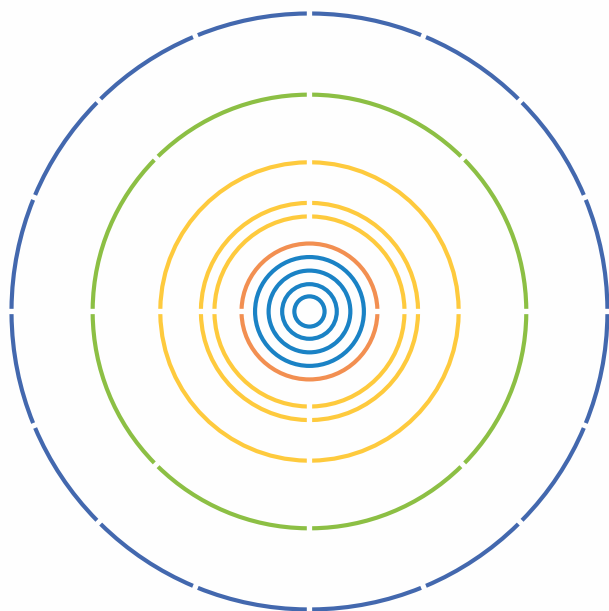

Escala 1:100
1000 mm

INDIVIDUAL (módulo único)

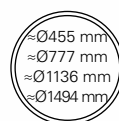

COMPOSTO (vários módulos)



Nº DE
MÓDULOS

VERSÃO DE
MÓDULOS

Nº DE
SUSPENSÕES

Dímetro

≈Ø455 mm	1	1/1 (360°)	3
≈Ø777 mm	1	1/1 (360°)	3
≈Ø1136 mm	1	1/1 (360°)	4
≈Ø1494 mm	1	1/1 (360°)	6
≈Ø1853 mm	2	1/2 (180°)	6
≈Ø2569 mm	4	1/4 (90°)	8
≈Ø2926 mm	4	1/4 (90°)	12
≈Ø4000 mm	4	1/4 (90°)	12
≈Ø5789 mm	8	1/8 (45°)	24
≈Ø7936 mm	16	1/16 (22,5°)	32



1. Musgo acústico

O musgo acústico pode transformar o ambiente do seu espaço.

Possui excelentes propriedades acústicas e de controle de humidade, ajudando a diminuir o ruído e a melhorar o ambiente de trabalho.



2. Painel acústico

O painel acústico tem uma excelente absorção de som, aumentando o conforto e o bem-estar de quem trabalha ou habita os espaços.

Disponíveis numa variedade de cores, perfeita para combinar com qualquer ambiente.



CONCEPT O 35 /E



Características do produto

Corpo

Alumínio



Acabamento

Revestido a epóxi-poliéster

230V/50Hz

Sistema ótico

bFLEX - Difusor opalino



Fonte de luz

LED, RG1, CRI>80, MacAdam Step ≤3

Vida útil LED

70.000h @ L90, B10, Ta 25°C



Fonte de alimentação

Driver LED 220-240V-50/60Hz incluído

Espessura do teto

Para tetos entre 1-25 mm

01. Seleccionar versão

CONCEPT O 35 / E



bFLEX - Difusor opalino

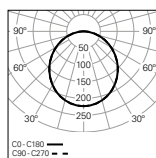

W	lm output	lm/W	Dmm	CÓDIGO*
36	3296	92	Ø458	90708L012▼▲◆00
68	6602	97	Ø780	90708L016▼▲◆00
97	9904	102	Ø1139	90708L024▼▲◆00
136	13205	97	Ø1497	90708L032▼▲◆00
166	16506	99	Ø1856	90708L040▼▲◆00
244	23108	95	Ø2572	90708L056▼▲◆00
272	26410	97	Ø2929	90708L064▼▲◆00
360	36313	101	Ø4003	90708L088▼▲◆00
544	52819	97	Ø5792	90708L128▼▲◆00
784	72626	93	Ø7939	90708L176▼▲◆00

CONCEPT O 35 / E

- Para diâmetros superiores a Ø1497 mm o produto é composto por vários módulos.
- Para obter as dimensões de corte, consulte as instruções de montagem do produto ou o nosso site.



*Substitua os símbolos para completar o código

Fonte de alimentação ▼

HF E

DALI H

Cor ¹ ▲

□ Branco W

■ Cinzento G

■ Preto B

■ Sahara 0

■ Mist 1

■ Carbon I

■ Autumn L

■ Rusty chain R

■ Jungle N

■ Golden eye D

■ Old rose 5

■ Copper 7

Temp. de Cor ◆

3000K 3

4000K 0

02. Seleccionar opções

OPÇÕES Código

SwitchDIM

- Sob consulta.

Cabo de segurança em aço

L1500 mm 955000



Detalhes do produto

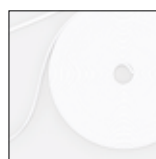

Difusor bFLEX

¹ Ver página 84.

CONCEPT O 35



Características do produto

Corpo

Alumínio

Acabamento

Revestido a epóxi-poliéster

Sistema ótico

bFLEX - Difusor opalino

Fonte de luz

LED, RG1, CRI>80, MacAdam Step ≤3

Vida útil LED

70.000h @ L90, B10, Ta 25°C

Fonte de alimentação

Driver LED 220-240V-50/60Hz incluído



230V/50Hz



IP 40



01. Seleccionar versão



CONCEPT O 35

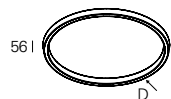

bFLEX - Difusor opalino

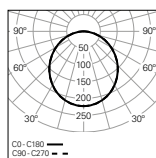

W	lm output	lm/W	Dmm	CÓDIGO*
36	3296	92	Ø455	90539L012▼▲◆00
68	6602	97	Ø777	90539L016▼▲◆00
97	9904	102	Ø1136	90539L024▼▲◆00
136	13205	97	Ø1494	90539L032▼▲◆00
166	16506	99	Ø1853	90539L040▼▲◆00
244	23108	95	Ø2569	90539L056▼▲◆00
272	26410	97	Ø2926	90539L064▼▲◆00
360	36313	101	Ø4000	90539L088▼▲◆00
544	52819	97	Ø5789	90539L128▼▲◆00
784	72626	93	Ø7936	90539L176▼▲◆00

*Substitua os símbolos para completar o código

Fonte de alimentação	
HF	E
DALI	H

Cor ¹	
□ Branco	W
■ Cinzento	G
■ Preto	B
■ Sahara	0
■ Mist	1
■ Carbon	I
■ Autumn	L
■ Rusty chain	R
■ Jungle	N
■ Golden eye	D
■ Old rose	5
■ Copper	7

CONCEPT O 35

- Para versão suspensa é necessário encomendar suspensão, cabo e caixa de alimentação em separado.
- Para diâmetros superiores a Ø1494 mm o produto é composto por vários módulos.
- Para auxiliar na configuração do produto, por favor consulte CONFIGURATOR.INDELAGUEGROUP.COM.

Temp. de Cor	
3000K	3
4000K	0

¹ Ver página 84.

02. Selecionar opções

OPÇÕES	Código*
SwitchDIM	
• Sob consulta.	
Suspensão	
S11 (x3) - Ø455, Ø777 mm	912903▲
S11 (x4) - Ø1136 mm	912904▲
S11 (x6) - Ø1494, Ø1853 mm	912906▲
S11 (x8) - Ø2569 mm	912908▲
S11 (x12) - Ø2926, Ø4000 mm	912912▲
S11 (x24) - Ø5789 mm	912924▲
S11 (x32) - Ø7936 mm	912932▲
Cabo de alimentação transparente	
L1500 mm - 3 x 0,75 mm ²	940400
L1500 mm - 5 x 0,75 mm ²	940500
L3000 mm - 3 x 0,75 mm ²	940401
L3000 mm - 5 x 0,75 mm ²	940501
L6000 mm - 3 x 0,75 mm ²	940402
L6000 mm - 5 x 0,75 mm ²	940507
Caixa de alimentação circular	
Saliente T24 D95 45  Ø95	978600▲
Encastrar T5 D90  Ø70 33  Ø90	971300▲
Caixa de alimentação central	
Saliente T20 3I - Ø455, Ø777 mm	977201▲
Saliente T20 4I - Ø1136 mm	977202▲
Saliente T20 6I - Ø1494 mm 45  Ø95	977204▲
Musgo acústico	
Ø455 mm	926800
Ø777 mm	926801
Ø1136 mm	926802
• Absorção de som e controlo de humidade. • Outros diâmetros sob consulta.	
Painel acústico	
Ø455 mm	926900
Ø777 mm	926901
Ø1136 mm	926902
• Absorção de som. • Outros diâmetros sob consulta.	



*Substitua os símbolos para completar o código

Comprimento	▲
L1500 mm	1
L3000 mm	2
L6000 mm	3

Cor	▲
<input type="checkbox"/> Branco	W
<input checked="" type="checkbox"/> Preto	B



Detalhes do produto



Difusor bFLEX



Caixas de alimentação



Musgo acústico



Musgo acústico (macro)



Painel acústico



Painel acústico (macro)



CONCEPT O 35 D/I



Características do produto

Corpo

Alumínio

Acabamento

Revestido a epóxi-poliéster

Sistema ótico

bFLEX - Difusor opalino

Fonte de luz

LED, RG1, CRI>80, MacAdam Step ≤3

Vida útil LED

70.000h @ L90, B10, Ta 25°C

Fonte de alimentação

Driver LED 220-240V-50/60Hz incluído



230V/50Hz



IP 40

bFLEX
960°C

01. Seleccionar versão



CONCEPT O 35 D/I

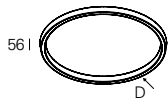

bFLEX - Difusor opalino (80%/20%)

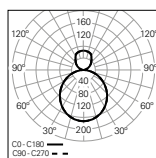

W	lm output	lm/W	Dmm	CÓDIGO*
83	8253	99	Ø777	90540L016▼▲◆00
128	12380	97	Ø1136	90540L024▼▲◆00
166	16506	99	Ø1494	90540L032▼▲◆00
220	20633	94	Ø1853	90540L040▼▲◆00
304	29711	98	Ø2569	90540L056▼▲◆00
332	33012	99	Ø2926	90540L064▼▲◆00
488	46217	95	Ø4000	90540L088▼▲◆00
664	66024	99	Ø5789	90540L128▼▲◆00
976	92434	95	Ø7936	90540L176▼▲◆00

*Substitua os símbolos para completar o código

Fonte de alimentação	
HF	E
DALI	H

Cor ¹	
□ Branco	W
■ Cinzento	G
■ Preto	B
■ Sahara	0
■ Mist	1
■ Carbon	I
■ Autumn	L
■ Rusty chain	R
■ Jungle	N
■ Golden eye	D
■ Old rose	5
■ Copper	7

CONCEPT O 35 D/I

- Para completar o produto é necessário encomendar suspensão, cabo e caixa de alimentação em separado.
- Para diâmetros superiores a Ø1494 mm o produto é composto por vários módulos.
- De forma a garantir uma total uniformidade de luz no teto, a instalação deverá ser feita a uma distância mínima de 500 mm.
- Para auxiliar na configuração do produto, por favor consulte CONFIGURATOR.INDELAGUEGROUP.COM.

Temp. de Cor	
3000K	3
4000K	0

¹ Ver página 84.

02. Selecionar opções

OPÇÕES	Código*
SwitchDIM	
• Sob consulta.	
Suspensão	
S11 (x3) - Ø777 mm	912903▲
S11 (x4) - Ø1136 mm	912904▲
S11 (x6) - Ø1494, Ø1853 mm	912906▲
S11 (x8) - Ø2569 mm	912908▲
S11 (x12) - Ø2926, Ø4000 mm	912912▲
S11 (x24) - Ø5789 mm	912924▲
S11 (x32) - Ø7936 mm	912932▲
Cabo de alimentação transparente	
L1500 mm - 3 x 0,75 mm ²	940400
L1500 mm - 5 x 0,75 mm ²	940500
L3000 mm - 3 x 0,75 mm ²	940401
L3000 mm - 5 x 0,75 mm ²	940501
L6000 mm - 3 x 0,75 mm ²	940402
L6000 mm - 5 x 0,75 mm ²	940507
Caixa de alimentação circular	
Saliente T24 D95  45 Ø95	978600▲
Encastrar T5 D90  Ø70 33 Ø90	971300▲
Caixa de alimentação central	
Saliente T20 3I - Ø777 mm	977201▲
Saliente T20 4I - Ø1136 mm	977202▲
Saliente T20 6I - Ø1494 mm	977204▲
45  Ø95	
Musgo acústico	
Ø777 mm	926801
Ø1136 mm	926802
• Absorção de som e controlo de humidade.	
• Outros diâmetros sob consulta.	
Painel acústico	
Ø777 mm	926901
Ø1136 mm	926902
• Absorção de som.	
• Outros diâmetros sob consulta.	



*Substitua os símbolos para completar o código

Comprimento	▲
L1500 mm	1
L3000 mm	2
L6000 mm	3

Cor	▲
<input type="checkbox"/> Branco	W
<input checked="" type="checkbox"/> Preto	B



Detalhes do produto



Luz indireta

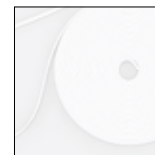

Difusor bFLEX



Musgo acústico



Musgo acústico (macro)



Painel acústico



Painel acústico (macro)



Caixas de alimentação



CONCEPT Sq 35



Características do produto

Corpo

Alumínio

Acabamento

Revestido a epóxi-poliéster

Sistema ótico

bFLEX - Difusor opalino

Fonte de luz

LED, RG1, CRI>80, MacAdam Step ≤3

Vida útil LED

70.000h @ L90, B10, Ta 25°C

Fonte de alimentação

Driver LED 220-240V-50/60Hz incluído



230V/50Hz



IP 40



01. Seleccionar versão

CONCEPT Sq 35

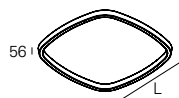

bFLEX - Difusor opalino

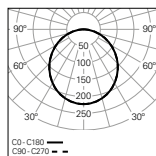

W	lm output	lm/W	Lmm	CÓDIGO*
112	10450	93	1126	90704L027▼▲◆00
140	13752	98	1441	90704L033▼▲◆00

CONCEPT Sq 35

• Para versão suspensa é necessário encomendar suspensão, cabo e caixa de alimentação em separado.



*Substitua os símbolos para completar o código

Fonte de alimentação	
HF	E
DALI	H

Cor ¹	
□ Branco	W
■ Cinzento	G
■ Preto	B
■ Sahara	0
■ Mist	1
■ Carbon	I
■ Autumn	L
■ Rusty chain	R
■ Jungle	N
■ Golden eye	D
■ Old rose	5
■ Copper	7

Temp. de Cor	
3000K	3
4000K	0

¹ Ver página 84.

02. Selecionar opções

OPÇÕES	Código*
SwitchDIM	
• Sob consulta.	
Suspensão	
S11 L1500 mm (x4)	9129041
S11 L3000 mm (x4)	9129042
S11 L6000 mm (x4)	9129043
Cabo de alimentação transparente	
L1500 mm - 3 x 0,75 mm ²	940400
L1500 mm - 5 x 0,75 mm ²	940500
L3000 mm - 3 x 0,75 mm ²	940401
L3000 mm - 5 x 0,75 mm ²	940501
L6000 mm - 3 x 0,75 mm ²	940402
L6000 mm - 5 x 0,75 mm ²	940507
Caixa de alimentação circular	
Saliente T24 D95  45 l Ø95	978600▲
Encastrar T5 D90  Ø70 33 l Ø90	971300▲
Caixa de alimentação central	
Saliente T20 4l  45 l Ø95	977202▲



*Substitua os símbolos para completar o código

Cor

<input type="checkbox"/> Branco	W
<input checked="" type="checkbox"/> Preto	B



Detalhes do produto



Difusor bFLEX



Caixas de alimentação

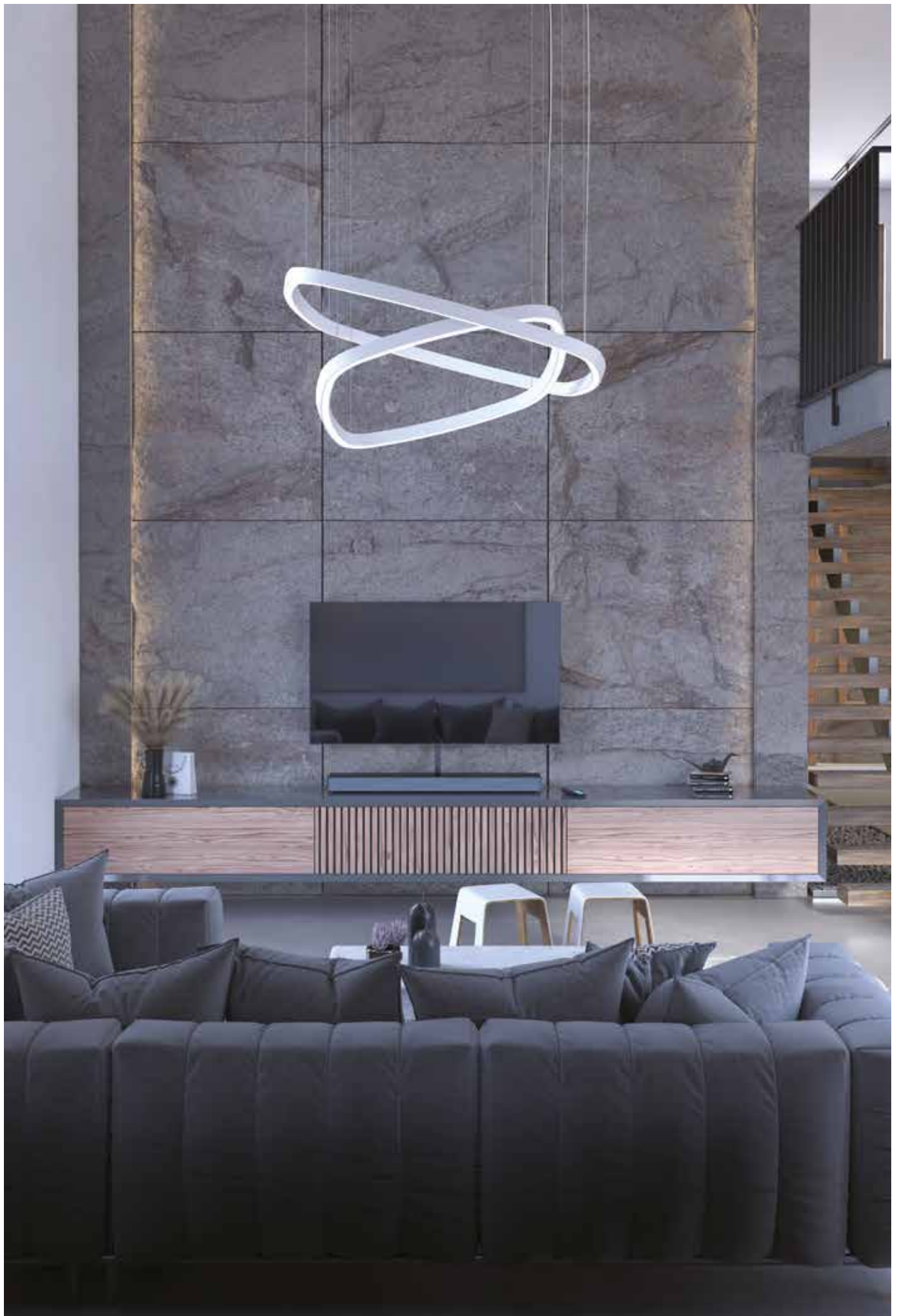

CONCEPT Sq 35 D/I



Características do produto

Corpo

Alumínio

Acabamento

Revestido a epóxi-poliéster

Sistema ótico

bFLEX - Difusor opalino

Fonte de luz

LED, RG1, CRI>80, MacAdam Step ≤3

Vida útil LED

70.000h @ L90, B10, Ta 25°C

Fonte de alimentação

Driver LED 220-240V-50/60Hz incluído



230V/50Hz



IP 40



01. Seleccionar versão



CONCEPT Sq 35 D/I

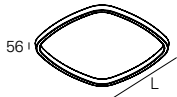

bFLEX - Difusor opalino (80%/20%)

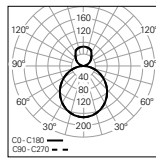

W	lm output	lm/W	Lmm	CÓDIGO*
140	13752	98	1126	90705L027▼▲◆0◆00
170	17053	100	1441	90705L033▼▲◆0◆00

*Substitua os símbolos para completar o código

Fonte de alimentação	
HF	E
DALI	H

Cor ¹	
□ Branco	W
■ Cinzento	G
■ Preto	B
■ Sahara	0
■ Mist	1
■ Carbon	I
■ Autumn	L
■ Rusty chain	R
■ Jungle	N
■ Golden eye	D
■ Old rose	5
■ Copper	7

CONCEPT Sq 35 D/I

- Para completar o produto é necessário encomendar suspensão, cabo e caixa de alimentação em separado.
- De forma a garantir uma total uniformidade de luz no teto, a instalação deverá ser feita a uma distância mínima de 500 mm.

Temp. de Cor	
3000K	3
4000K	0

¹ Ver página 84.

02. Selecionar opções

OPÇÕES	Código*
SwitchDIM	
• Sob consulta.	
Suspensão	
S11 L1500 mm (x4)	9129041
S11 L3000 mm (x4)	9129042
S11 L6000 mm (x4)	9129043
Cabo de alimentação transparente	
L1500 mm - 3 x 0,75 mm ²	940400
L1500 mm - 5 x 0,75 mm ²	940500
L3000 mm - 3 x 0,75 mm ²	940401
L3000 mm - 5 x 0,75 mm ²	940501
L6000 mm - 3 x 0,75 mm ²	940402
L6000 mm - 5 x 0,75 mm ²	940507
Caixa de alimentação circular	
Saliente T24 D95  45 l Ø95	978600▲
Encastrar T5 D90  Ø70 33 l Ø90	971300▲
Caixa de alimentação central	
Saliente T20 4l  45 l Ø95	977202▲



*Substitua os símbolos para completar o código

Cor

<input type="checkbox"/> Branco	W
<input checked="" type="checkbox"/> Preto	B



Detalhes do produto



Luz indireta

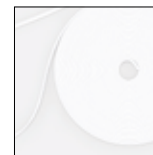

Difusor bFLEX



Caixas de alimentação



CONCEPT D 35



Características do produto

Corpo

Alumínio

Acabamento

Revestido a epóxi-poliéster

Sistema ótico

bFLEX - Difusor opalino

Fonte de luz

LED, RG1, CRI>80, MacAdam Step ≤ 3

Vida útil LED

70.000h @ L90, B10, Ta 25°C

Fonte de alimentação

Driver LED 220-240V-50/60Hz incluído



230V/50Hz



IP 40



01. Seleccionar versão

CONCEPT D 35



bFLEX - Difusor opalino

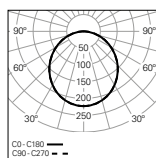

W	lm output	lm/W	Lmm	CÓDIGO*
108	9900	92	1187	90706L027▼▲◆00
135	12376	92	1465	90706L033▼▲◆00

CONCEPT D 35

• Para versão suspensa é necessário encomendar suspensão, cabo e caixa de alimentação em separado.



*Substitua os símbolos para completar o código

Fonte de alimentação	
HF	E
DALI	H

Cor ¹	
□ Branco	W
■ Cinzento	G
■ Preto	B
■ Sahara	0
■ Mist	1
■ Carbon	I
■ Autumn	L
■ Rusty chain	R
■ Jungle	N
■ Golden eye	D
■ Old rose	5
■ Copper	7

Temp. de Cor	
3000K	3
4000K	0

¹ Ver página 84.

02. Selecionar opções

OPÇÕES	Código*
SwitchDIM	
• Sob consulta.	
Suspensão	
S11 L1500 mm (x3)	9129031
S11 L3000 mm (x3)	9129032
S11 L6000 mm (x3)	9129033
Cabo de alimentação transparente	
L1500 mm - 3 x 0,75 mm ²	940400
L1500 mm - 5 x 0,75 mm ²	940500
L3000 mm - 3 x 0,75 mm ²	940401
L3000 mm - 5 x 0,75 mm ²	940501
L6000 mm - 3 x 0,75 mm ²	940402
L6000 mm - 5 x 0,75 mm ²	940507
Caixa de alimentação circular	
Saliente T24 D95  45 l Ø95	978600▲
Encastrar T5 D90  Ø70 33 l Ø90	971300▲
Caixa de alimentação central	
Saliente T20 3l  45 l Ø95	977201▲



*Substitua os símbolos para completar o código

Cor	▲
<input type="checkbox"/> Branco	W
<input checked="" type="checkbox"/> Preto	B



Detalhes do produto



Difusor bFLEX



Caixas de alimentação



CONCEPT D 35 D/I



Características do produto

Corpo

Alumínio

Acabamento

Revestido a epóxi-poliéster

Sistema ótico

bFLEX - Difusor opalino

Fonte de luz

LED, RG1, CRI>80, MacAdam Step ≤ 3

Vida útil LED

70.000h @ L90, B10, Ta 25°C

Fonte de alimentação

Driver LED 220-240V-50/60Hz incluído



230V/50Hz



IP 40



01. Seleccionar versão

CONCEPT D 35 D/I



bFLEX - Difusor opalino (80%/20%)

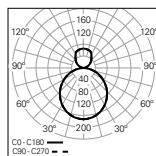

W	lm output	lm/W	Lmm	CÓDIGO*
135	12376	92	1187	90707L027▼▲0◆00
171	16090	94	1465	90707L033▼▲0◆00

CONCEPT D 35 D/I

- Para completar o produto é necessário encomendar suspensão, cabo e caixa de alimentação em separado.
- De forma a garantir uma total uniformidade de luz no teto, a instalação deverá ser feita a uma distância mínima de 500 mm.



*Substitua os símbolos para completar o código

Fonte de alimentação	
HF	E
DALI	H

Cor ¹	
□ Branco	W
■ Cinzento	G
■ Preto	B
■ Sahara	0
■ Mist	1
■ Carbon	I
■ Autumn	L
■ Rusty chain	R
■ Jungle	N
■ Golden eye	D
■ Old rose	5
■ Copper	7

Temp. de Cor	
3000K	3
4000K	0

¹ Ver página 84.

02. Selecionar opções

OPÇÕES	Código*
SwitchDIM	
• Sob consulta.	
Suspensão	
S11 L1500 mm (x3)	9129031
S11 L3000 mm (x3)	9129032
S11 L6000 mm (x3)	9129033
Cabo de alimentação transparente	
L1500 mm - 3 x 0,75 mm ²	940400
L1500 mm - 5 x 0,75 mm ²	940500
L3000 mm - 3 x 0,75 mm ²	940401
L3000 mm - 5 x 0,75 mm ²	940501
L6000 mm - 3 x 0,75 mm ²	940402
L6000 mm - 5 x 0,75 mm ²	940507
Caixa de alimentação circular	
Saliente T24 D95  45 l Ø95	978600▲
Encastrar T5 D90  Ø70 33 l Ø90	971300▲
Caixa de alimentação central	
Saliente T20 3l  45 l Ø95	977201▲



*Substitua os símbolos para completar o código

Cor

<input type="checkbox"/> Branco	W
<input checked="" type="checkbox"/> Preto	B



Detalhes do produto



Luz indireta

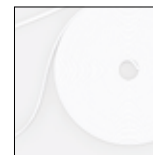

Difusor bFLEX



Caixas de alimentação





CONCEPT 65



CONCEPT S 65
138



CONCEPT S 65 D/I
142



CONCEPT O 65
146



CONCEPT O 65 D/I
150



Tipos de aplicação







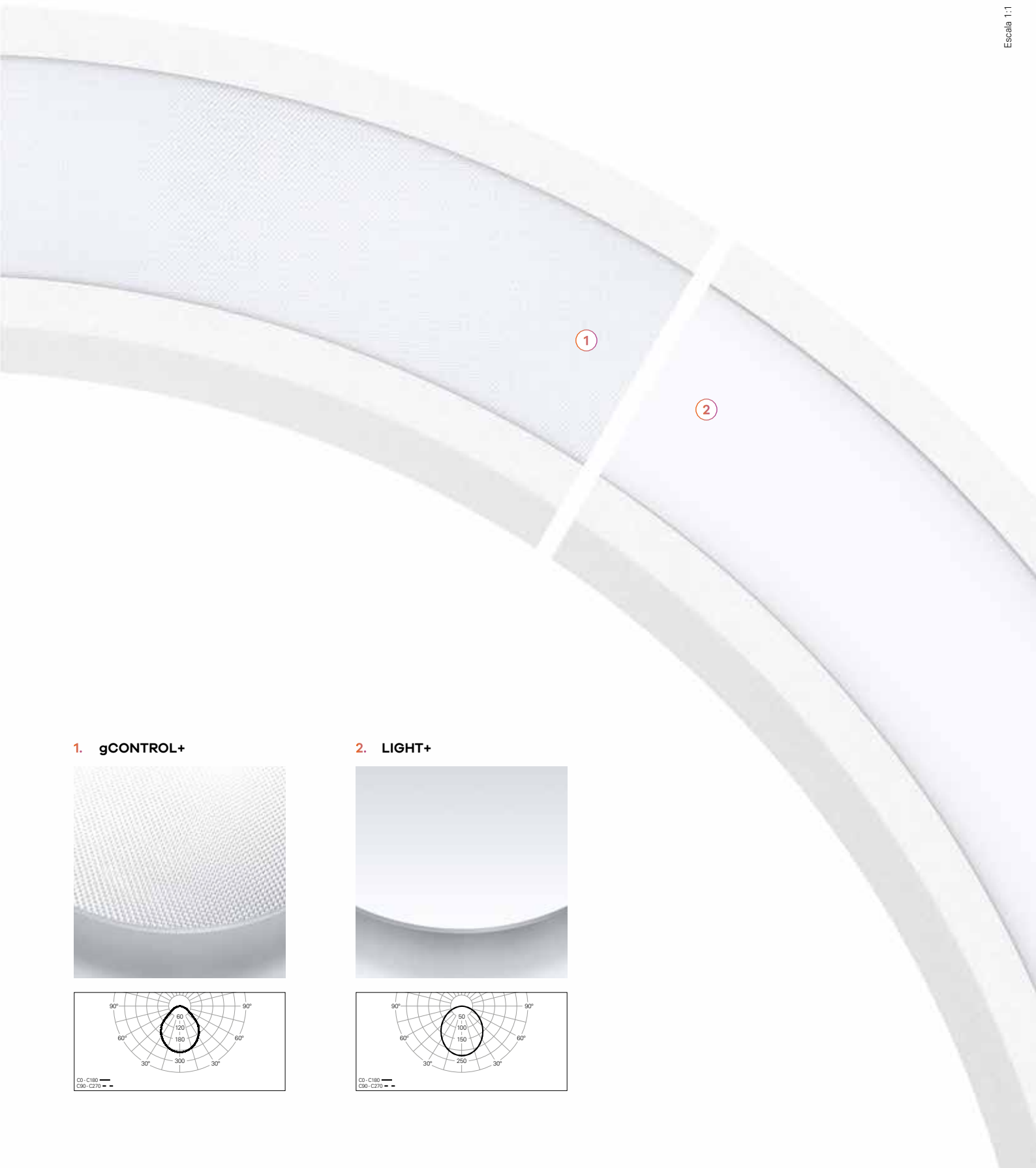

1. gCONTROL+

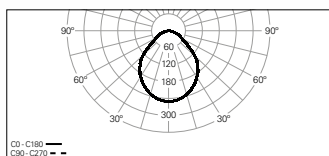

2. LIGHT+

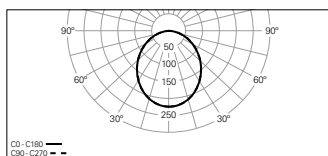

Defina a sua cor

ILUMINAÇÃO
ARQUITETURAL

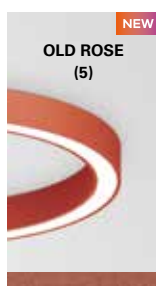
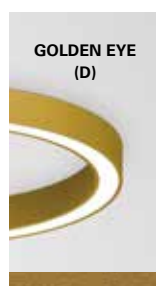
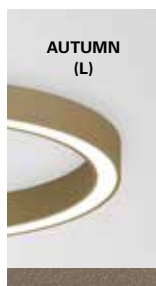
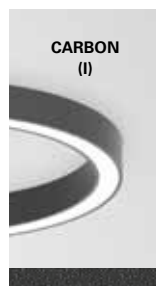
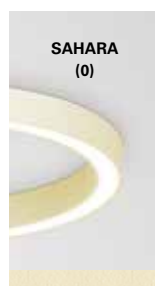
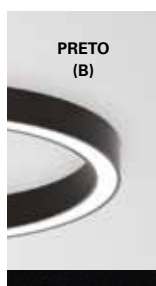
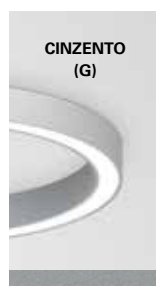
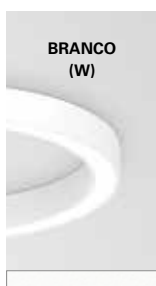

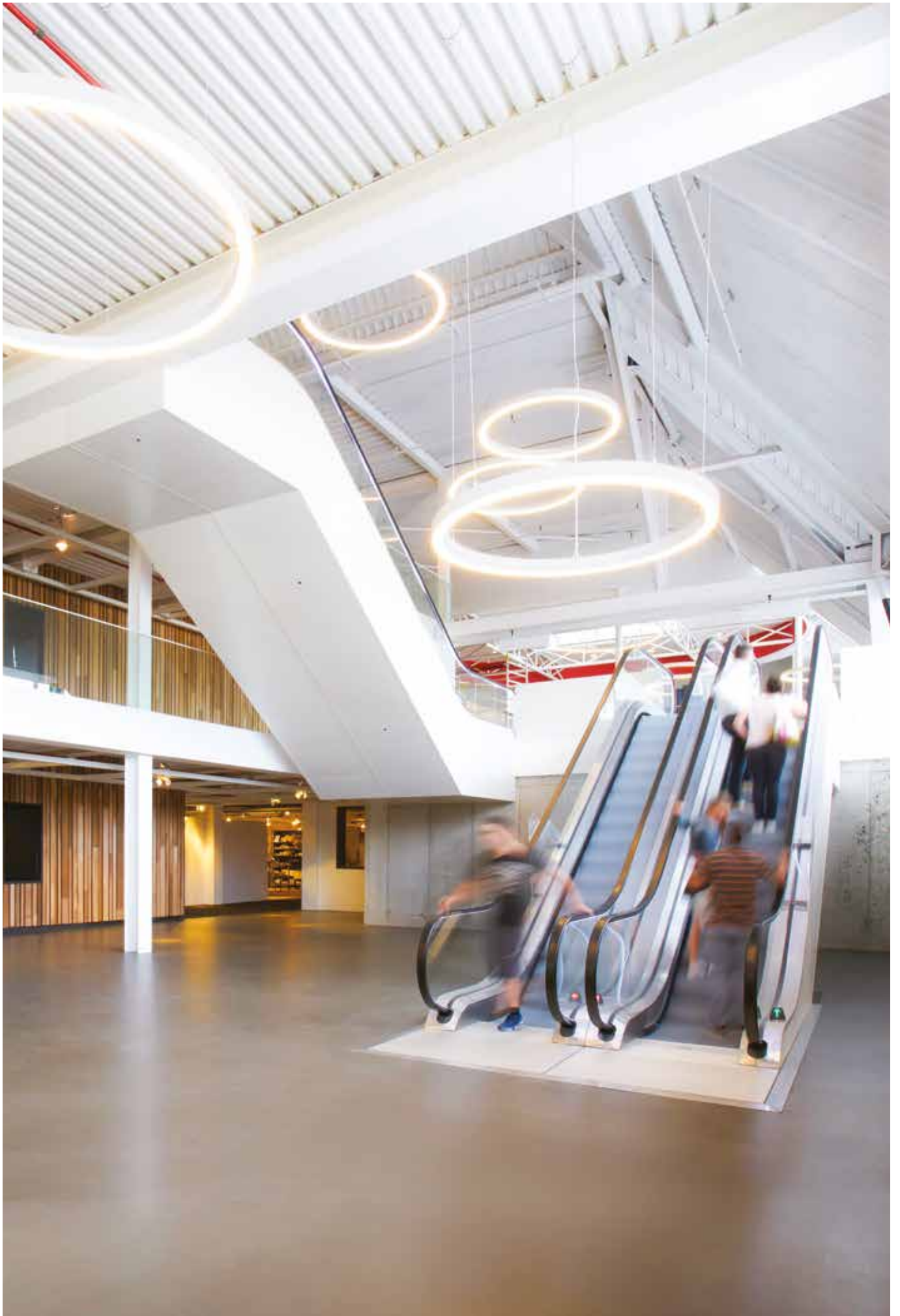

CONCEPT S 65



Características do produto

Corpo

Alumínio

Acabamento

Revestido a epóxi-poliéster

Sistema ótico

LIGHT+ - Difusor opalino

Fonte de luz

LED, RG1, CRI>80, MacAdam Step ≤ 3

Vida útil LED

80.000h @ L80, B10, Ta 25°C

Fonte de alimentação

Driver LED 220-240V-50/60Hz incluído



230V/50Hz



IP 20

650°C

01. Selecionar módulo



MÓDULO CURVO

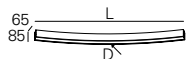

1/16 (22,5°) | LIGHT+ - Difusor opalino

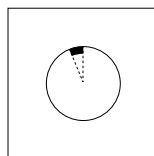

W	lm output	lm/W	Lmm	Dmm	CÓDIGO*
27	2776	103	1531	Ø7850	90781L010▼▲◆00

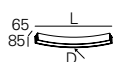

1/8 (45°) | LIGHT+ - Difusor opalino

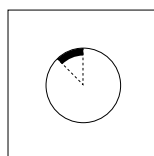

W	lm output	lm/W	Lmm	Dmm	CÓDIGO*
15	1388	93	784	Ø2050	90782L005▼▲◆00
18	1666	93	937	Ø2450	90782L006▼▲◆00
20	1943	97	1071	Ø2800	90782L007▼▲◆00
22	2221	101	1224	Ø3200	90782L008▼▲◆00

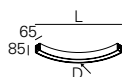

1/4 (90°) | LIGHT+ - Difusor opalino

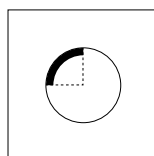

W	lm output	lm/W	Lmm	Dmm	CÓDIGO*
15	1388	93	742	Ø1050	90783L005▼▲◆00
18	1666	93	884	Ø1250	90783L006▼▲◆00
20	1943	97	1025	Ø1450	90783L007▼▲◆00
22	2221	101	1166	Ø1650	90783L008▼▲◆00
25	2498	100	1308	Ø1850	90783L009▼▲◆00
27	2776	103	1414	Ø2000	90783L010▼▲◆00
39	3886	100	1980	Ø2800	90783L014▼▲◆00
44	4441	101	2262	Ø3200	90783L016▼▲◆00
53	5552	105	2828	Ø4000	90783L020▼▲◆00

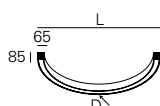

1/2 (180°) | LIGHT+ - Difusor opalino

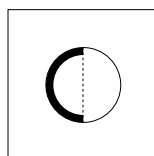

W	lm output	lm/W	Lmm	Dmm	CÓDIGO*
22	2221	101	850	Ø850	90784L008▼▲◆00
27	2776	103	1050	Ø1050	90784L010▼▲◆00
33	3331	101	1250	Ø1250	90784L012▼▲◆00
39	3886	100	1450	Ø1450	90784L014▼▲◆00
44	4441	101	1650	Ø1650	90784L016▼▲◆00
48	4997	104	1850	Ø1850	90784L018▼▲◆00
53	5552	105	2000	Ø2000	90784L020▼▲◆00

MÓDULO LINEAR

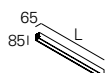

LINEA | LIGHT+ - Difusor opalino

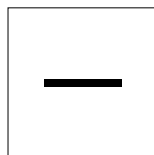

W	lm output	lm/W	Lmm	CÓDIGO*
15	1388	93	750	90789L005▼▲◆00
20	1943	97	1050	90789L007▼▲◆00
25	2498	100	1350	90789L009▼▲◆00
30	3053	102	1650	90789L011▼▲◆00
36	3609	100	1950	90789L013▼▲◆00

MÓDULO CURVO | MÓDULO LINEAR

- Para completar a linha é necessário encomendar start kit, cablagem de linha contínua e kit de união em separado.
- Para versão suspensa é necessário encomendar suspensão, cabo e caixa de alimentação em separado.
- Dimensões não incluem start kit. Adicione 4 mm ao comprimento para completar a linha.

*Substitua os símbolos para completar o código

Fonte de alimentação ▼
 HF E
 DALI H

Cor ¹ ▲
 □ Branco W
 ■ Cinzento G
 ■ Preto B
 ■ Sahara 0
 ■ Mist 1
 ■ Carbon I
 ■ Autumn L
 ■ Rusty chain R
 ■ Jungle N
 ■ Golden eye D
 ■ Old rose 5
 ■ Copper 7

Temp. de Cor ◆
 3000K 3
 4000K 0

02. Selecionar opções

OPÇÕES	Código*
Start kit - topo início/fim • Dois topos incluídos.	65 921750▲ 851 2
Cablagem linha contínua 3 x 1,5 m ² 5 x 1,5 m ²	949200 949201
Kit de união (x1) • Parafusos incluídos.	931100▲
Suspensão • Para todas as versões curvas: S1 L1500 mm (x3) S1 L3000 mm (x3) S1 L6000 mm (x3) • Para todas as versões lineares: S1 L1500 mm (x2) S1 L3000 mm (x2) S1 L6000 mm (x2)	910005 910015 910016 910001 910011 910012
Cabo de alimentação transparente L1500 mm - 3 x 1,5 mm ² L1500 mm - 5 x 1,5 mm ² L3000 mm - 3 x 1,5 mm ² L3000 mm - 5 x 1,5 mm ² L6000 mm - 3 x 1,5 mm ² L6000 mm - 5 x 1,5 mm ²	940300 940000 940301 940001 940302 940002
Caixa de alimentação circular¹ Saliente T24 D95 Encastrar T5 D90	451 Ø95 978600▲ Ø70 331 Ø90 971300▲



*Substitua os símbolos para completar o código

Cor ¹²	▲
□ Branco	W
■ Cinzento	G
■ Preto	B
■ Sahara	0
■ Mist	1
■ Carbon	I
■ Autumn	L
■ Rusty chain	R
■ Jungle	N
■ Golden eye	D
■ Old rose	5
■ Copper	7



Detalhes do produto



Difusor LIGHT+



Caixas de alimentação



CONCEPT S 65 D/I



Características do produto

Corpo

Alumínio



Acabamento

Revestido a epóxi-poliéster

230V/50Hz

Sistema ótico

LIGHT+ - Difusor opalino



IP 20

Fonte de luz

LED, RG1, CRI>80, MacAdam Step ≤3

Vida útil LED

80.000h @ L80, B10, Ta 25°C

650°C

Fonte de alimentação

Driver LED 220-240V-50/60Hz incluído

01. Selecionar módulo



MÓDULO CURVO

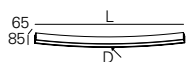

1/16 (22,5°) | LIGHT+ - Difusor opalino (80%/20%)

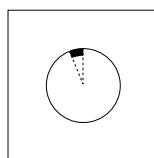

W	lm output	lm/W	Lmm	Dmm	CÓDIGO*
33	3390	103	1531	Ø7850	90785L010▼▲◆0◆00

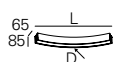

1/8 (45°) | LIGHT+ - Difusor opalino (80%/20%)

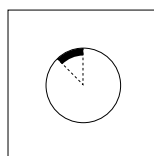

W	lm output	lm/W	Lmm	Dmm	CÓDIGO*
22	2260	103	1071	Ø2800	90786L007▼▲◆0◆00
25	2542	102	1224	Ø3200	90786L008▼▲◆0◆00

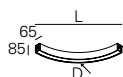

1/4 (90°) | LIGHT+ - Difusor opalino (80%/20%)

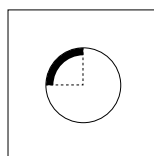

W	lm output	lm/W	Lmm	Dmm	CÓDIGO*
25	2542	102	1164	Ø1650	90787L008▼▲◆0◆00
30	3107	104	1305	Ø1850	90787L009▼▲◆0◆00
33	3390	103	1411	Ø2000	90787L010▼▲◆0◆00
47	4802	102	1977	Ø2800	90787L014▼▲◆0◆00
50	5367	107	2260	Ø3200	90787L016▼▲◆0◆00
63	6497	103	2826	Ø4000	90787L020▼▲◆0◆00

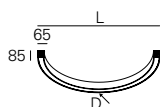

1/2 (180°) | LIGHT+ - Difusor opalino (80%/20%)

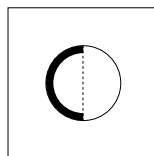

W	lm output	lm/W	Lmm	Dmm	CÓDIGO*
33	3390	103	1050	Ø1050	90788L010▼▲◆0◆00
39	3954	101	1250	Ø1250	90788L012▼▲◆0◆00
47	4802	102	1450	Ø1450	90788L014▼▲◆0◆00
50	5367	107	1650	Ø1650	90788L016▼▲◆0◆00
55	5932	108	1850	Ø1850	90788L018▼▲◆0◆00
63	6497	103	2000	Ø2000	90788L020▼▲◆0◆00

MÓDULO LINEAR

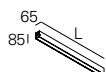

LINEA | LIGHT+ - Difusor opalino (80%/20%)

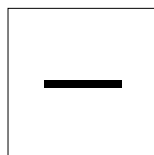

W	lm output	lm/W	Lmm	CÓDIGO*
30	3118	104	1350	90790L009▼▲◆0◆00
39	3976	102	1650	90790L011▼▲◆0◆00
44	4502	102	1950	90790L013▼▲◆0◆00

*Substitua os símbolos para completar o código

Fonte de alimentação ▼
HF E
DALI H

Cor ¹ ▲
□ Branco W
■ Cinzento G
■ Preto B
■ Sahara 0
■ Mist 1
■ Carbon I
■ Autumn L
■ Rusty chain R
■ Jungle N
■ Golden eye D
■ Old rose 5
■ Copper 7





Temp. de Cor ◆
3000K 3
4000K 0

MÓDULO CURVO | MÓDULO LINEAR

- Para completar a linha é necessário encomendar start kit, cablagem de linha contínua e kit de união em separado.
- Para completar o produto é necessário encomendar suspensão, cabo e caixa de alimentação em separado.
- Dimensões não incluem start kit. Adicione 4 mm ao comprimento para completar a linha.
- De forma a garantir uma total uniformidade de luz no teto, a instalação deverá ser feita a uma distância mínima de 500 mm.

¹ Ver página 136.

02. Selecionar opções

OPÇÕES	Código*
Start kit - topo início/fim • Dois topos incluídos.	65 921750♣ 85  2
Cablagem linha contínua 3 x 1,5 m ² 5 x 1,5 m ²	949200 949201
Kit de união (x1) • Parafusos incluídos.	931100♣
Suspensão • Para todas as versões curvas:	
S1 L1500 mm (x3)	910005
S1 L3000 mm (x3)	910015
S1 L6000 mm (x3)	910016
• Para todas as versões lineares:	
S1 L1500 mm (x2)	910001
S1 L3000 mm (x2)	910011
S1 L6000 mm (x2)	910012
Cabo de alimentação transparente	
L1500 mm - 3 x 1,5 mm ²	940300
L1500 mm - 5 x 1,5 mm ²	940000
L3000 mm - 3 x 1,5 mm ²	940301
L3000 mm - 5 x 1,5 mm ²	940001
L6000 mm - 3 x 1,5 mm ²	940302
L6000 mm - 5 x 1,5 mm ²	940002
Caixa de alimentação circular¹	
Saliente T24 D95  45  Ø95	978600♣
Encastrar T5 D90  Ø70 33  Ø90	971300♣



*Substitua os símbolos para completar o código

Cor ¹²	♣
<input type="checkbox"/> Branco	W
<input type="checkbox"/> Cinzento	G
<input type="checkbox"/> Preto	B
<input type="checkbox"/> Sahara	0
<input type="checkbox"/> Mist	1
<input type="checkbox"/> Carbon	I
<input type="checkbox"/> Autumn	L
<input type="checkbox"/> Rusty chain	R
<input type="checkbox"/> Jungle	N
<input type="checkbox"/> Golden eye	D
<input type="checkbox"/> Old rose	5
<input type="checkbox"/> Copper	7



Detalhes do produto



Difusor LIGHT+



Luz indireta



Caixas de alimentação



CONCEPT O 65



Características do produto

Corpo

Alumínio

Acabamento

Revestido a epóxi-poliéster

Sistema ótico

gCONTROL+ - Difusor microprismático
LIGHT+ - Difusor opalino

Fonte de luz

LED, RG1, CRI>80, MacAdam Step ≤3

Vida útil LED

80.000h @ L90, B10, Ta 25°C

Fonte de alimentação

Driver LED 220-240V-50/60Hz incluído



230V/50Hz



IP 20

650°C

01. Seleccionar versão

CONCEPT O 65

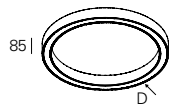

gCONTROL+ - Difusor microprismático

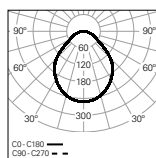

UGR	W	lm output	lm/W	Dmm	CÓDIGO*
≤19	38	3722	98	Ø600	90625L600▼▲0♦00
≤19	54	5377	100	Ø900	90625L900▼▲♦♦00
≤19	77	7858	102	Ø1200	90625L120▼▲♦♦00
≤19	91	9099	100	Ø1500	90625L150▼▲♦♦00

LIGHT+ - Difusor opalino

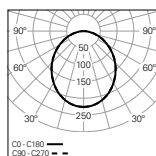

UGR	W	lm output	lm/W	Dmm	CÓDIGO*
≤22	38	3993	105	Ø600	90635L600▼▲0♦00
≤22	54	5768	107	Ø900	90635L900▼▲♦♦00
≤22	77	8430	109	Ø1200	90635L120▼▲♦♦00
≤22	91	9761	107	Ø1500	90635L150▼▲♦♦00

CONCEPT O 65

• Para versão suspensa é necessário encomendar suspensão, cabo e caixa de alimentação em separado.



*Substitua os símbolos para completar o código

Fonte de alimentação	
HF	E
DALI	H

Cor ¹	
□ Branco	W
■ Cinzento	G
■ Preto	B
■ Sahara	0
■ Mist	1
■ Carbon	I
■ Autumn	L
■ Rusty chain	R
■ Jungle	N
■ Golden eye	D
■ Old rose	5
■ Copper	7



Emergência	
No EM	0
EM 3h (K3) ²	3

Temp. de Cor	
3000K	3
4000K	0

¹ Ver página 136.

² Preparado para telecommando.

02. Selecionar opções

OPÇÕES	Código*
Bluetooth	927200
• Módulo bluetooth controlável através de smartphone.	
Suspensão	
S10 L1500 mm (x3)	9111001
S10 L3000 mm (x3)	9111002
S10 L6000 mm (x3)	9111003
Cabo de alimentação transparente	
L1500 mm - 3 x 0,75 mm ²	940400
L1500 mm - 5 x 0,75 mm ²	940500
L1500 mm - 7 x 0,75 mm ²	940600
L3000 mm - 3 x 0,75 mm ²	940401
L3000 mm - 5 x 0,75 mm ²	940501
L3000 mm - 7 x 0,75 mm ²	940601
L6000 mm - 3 x 0,75 mm ²	940402
L6000 mm - 5 x 0,75 mm ²	940507
L6000 mm - 7 x 0,75 mm ²	940602
• Para a versão DALI com kit de emergência e telecomando é necessário encomendar 2 cabos de alimentação 5 x 0,75 mm ² .	
Caixa de alimentação circular	
Saliente T24 D95  45 l Ø95	978600♣
Saliente T26 D95 (DALI+K3)	978601♣
Encastrar T5 D90  Ø70 33 l Ø90	971300♣
Encastrar T27 D90 (DALI+K3)	978700♣
Caixa de alimentação central	
Saliente T21 3l D95  45 l Ø95	977211♣
Saliente T28 3l D95 (DALI+K3)	977230♣



*Substitua os símbolos para completar o código

Cor

<input type="checkbox"/> Branco	W
<input checked="" type="checkbox"/> Preto	B



Detalhes do produto



Aplicação saliente

Aplicação suspensa



Aplicação suspensa com caixa central

Aplicação de parede



Difusor gCONTROL+

Difusor LIGHT+

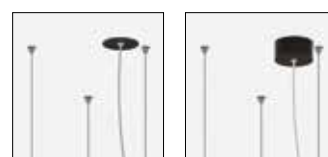

Suspensão paralela com caixa de encastrar

Suspensão paralela com caixa saliente



Suspensão central

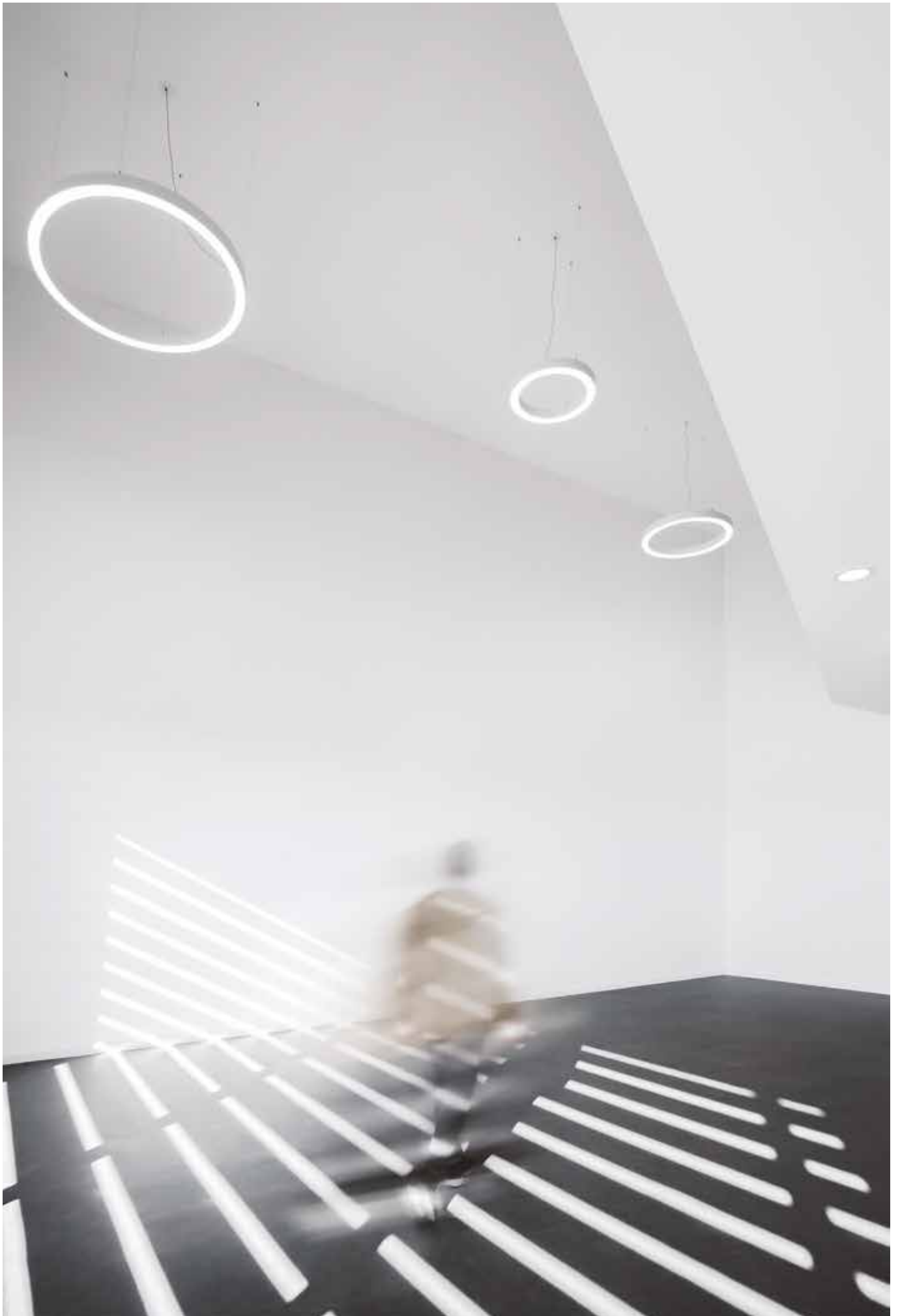

CONCEPT O 65 D/I



Características do produto

Corpo

Alumínio

Acabamento

Revestido a epóxi-poliéster

Sistema ótico

gCONTROL+ - Difusor microprismático
LIGHT+ - Difusor opalino

Fonte de luz

LED, RG1, CRI>80, MacAdam Step ≤3

Vida útil LED

80.000h @ L90, B10, Ta 25°C

Fonte de alimentação

Driver LED 220-240V-50/60Hz incluído



230V/50Hz



IP 20

650°C

01. Seleccionar versão

CONCEPT O 65 D/I

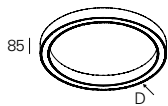

gCONTROL+ - Difusor microprismático (80%/20%)

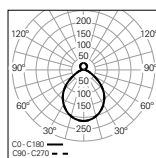

UGR	W	lm output	lm/W	Dmm	CÓDIGO*
≤19	44	4580	104	Ø600	90626L600▼▲◆0◆00
≤19	63	6651	106	Ø900	90626L900▼▲◆0◆00
≤19	92	9596	104	Ø1200	90626L120▼▲◆0◆00
≤19	110	11558	105	Ø1500	90626L150▼▲◆0◆00

LIGHT+ - Difusor opalino (80%/20%)

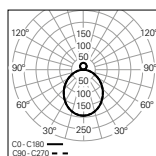

UGR	W	lm output	lm/W	Dmm	CÓDIGO*
≤22	44	4817	109	Ø600	90636L600▼▲◆0◆00
≤22	63	6995	111	Ø900	90636L900▼▲◆0◆00
≤22	92	10092	110	Ø1200	90636L120▼▲◆0◆00
≤22	110	12156	111	Ø1500	90636L150▼▲◆0◆00

CONCEPT O 65

- Para completar o produto é necessário encomendar suspensão, cabo e caixa de alimentação em separado.
- De forma a garantir uma total uniformidade de luz no teto, a instalação deverá ser feita a uma distância mínima de 500 mm.



*Substitua os símbolos para completar o código

Fonte de alimentação	
HF	E
DALI	H

Cor ¹	
□ Branco	W
■ Cinzento	G
■ Preto	B
■ Sahara	0
■ Mist	1
■ Carbon	I
■ Autumn	L
■ Rusty chain	R
■ Jungle	N
■ Golden eye	D
■ Old rose	5
■ Copper	7

Emergência	
No EM	0
EM 3h (K3) ²	3

Temp. de Cor	
3000K	3
4000K	0

¹ Ver página 136.

² Preparado para telecomando.

02. Selecionar opções

OPÇÕES	Código*
Bluetooth	927200
• Módulo bluetooth controlável através de smartphone.	
Suspensão	
S10 L1500 mm (x3)	9111001
S10 L3000 mm (x3)	9111002
S10 L6000 mm (x3)	9111003
Cabo de alimentação transparente	
L1500 mm - 3 x 0,75 mm ²	940400
L1500 mm - 5 x 0,75 mm ²	940500
L1500 mm - 7 x 0,75 mm ²	940600
L3000 mm - 3 x 0,75 mm ²	940401
L3000 mm - 5 x 0,75 mm ²	940501
L3000 mm - 7 x 0,75 mm ²	940601
L6000 mm - 3 x 0,75 mm ²	940402
L6000 mm - 5 x 0,75 mm ²	940507
L6000 mm - 7 x 0,75 mm ²	940602
• Para a versão DALI com kit de emergência e telecomando é necessário encomendar 2 cabos de alimentação 5 x 0,75 mm ² .	
Caixa de alimentação circular	
Saliente T24 D95  45 l Ø95	978600♣
Saliente T26 D95 (DALI+K3)	978601♣
Encastrar T5 D90  Ø70 33 l Ø90	971300♣
Encastrar T27 D90 (DALI+K3)	978700♣
Caixa de alimentação central	
Saliente T21 3l D95  45 l Ø95	977211♣
Saliente T28 3l D95 (DALI+K3)	977230♣



*Substitua os símbolos para completar o código

Cor

<input type="checkbox"/> Branco	W
<input checked="" type="checkbox"/> Preto	B



Detalhes do produto



Aplicação suspensa

Aplicação suspensa com caixa central



Difusor gCONTROL+

Difusor LIGHT+



Luz indireta

Suspensão paralela com caixa de encastrar



Suspensão paralela com caixa saliente

Suspensão central

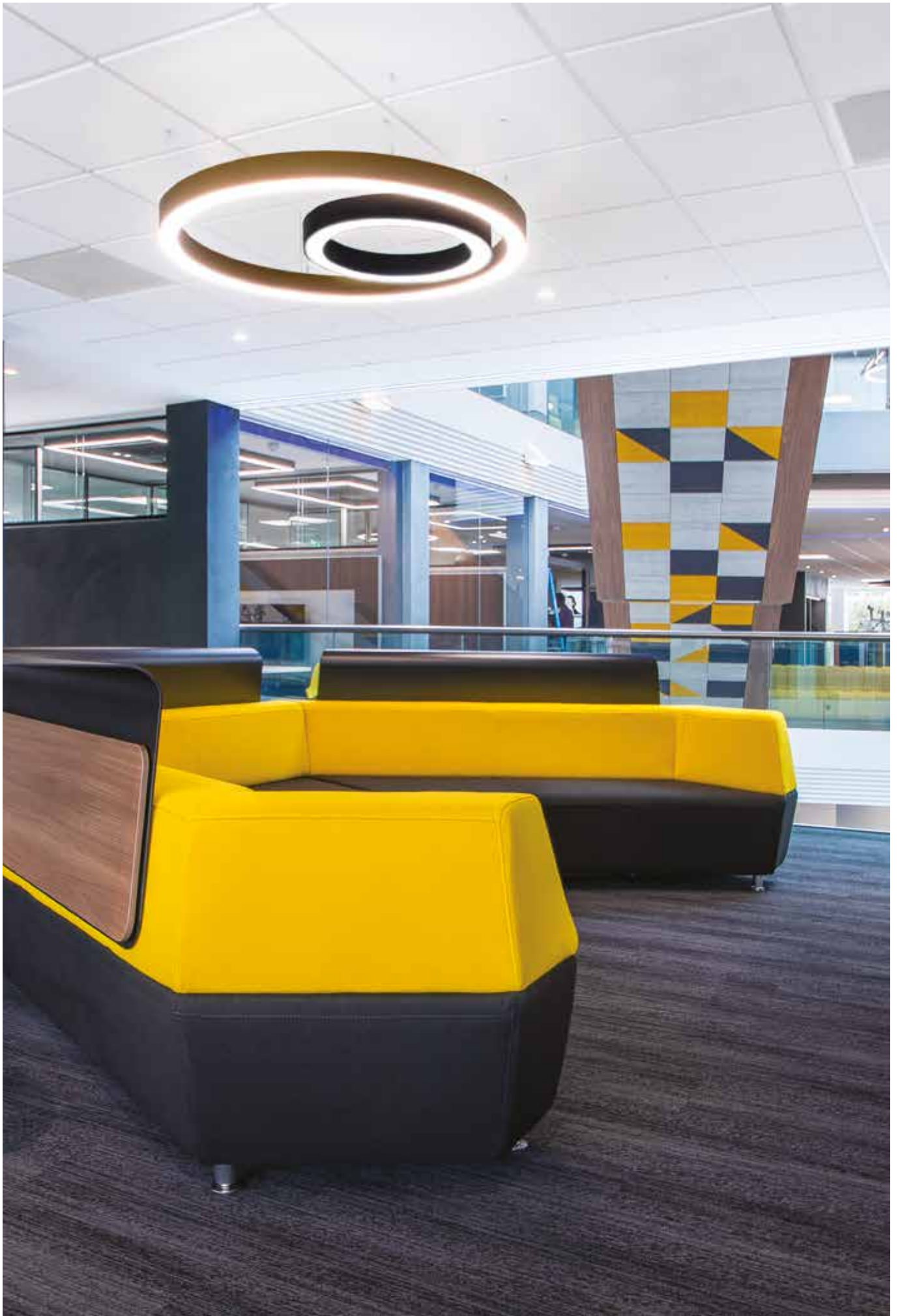

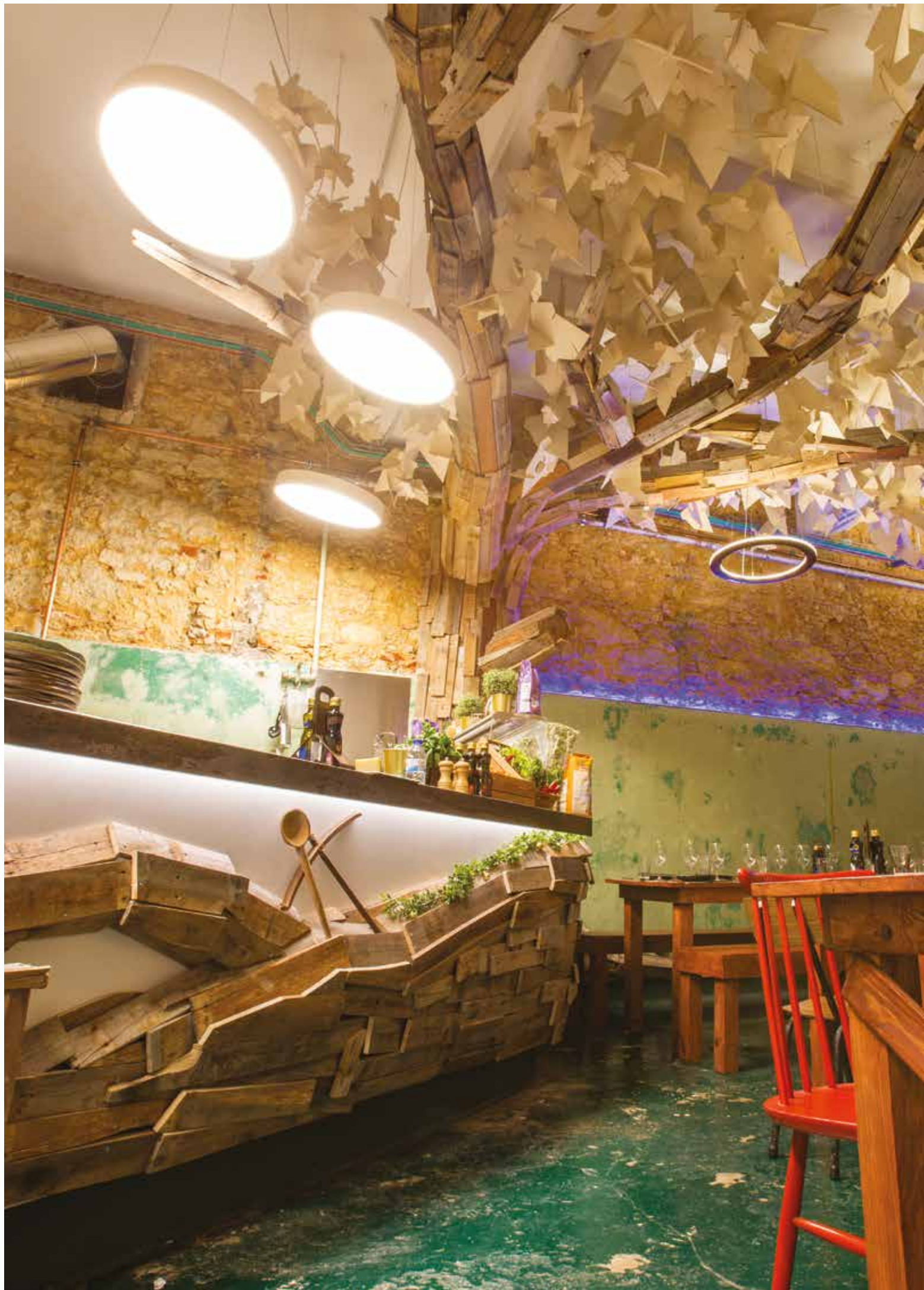

ROFY



ROFY 60 / T
166



ROFY 60 / T D/I
168



ROFY 60
172



ROFY 60 D/I
176



ROFY 85 / E
180



ROFY 85
182



ROFY 85 D/I
186



ROFY 85 IP / E
190



ROFY 85 IP / C
192



Tipos de aplicação





**1. Encastrar
com aba**

**2. Trimless
Direta**

**3. Trimless
Direta / Indireta**

**4. Parede
Direta**

**5. Parede
Direta / Indireta**

**6. Saliente
Direta**

**7. Saliente
Direta / Indireta**

**8. Suspensa
Direta**

**9. Suspensa
Direta / Indireta**

**Duas versões
disponíveis**



ROFY 60





ROFY 85

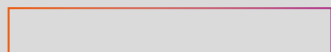

85 mm



1. gCONTROL+

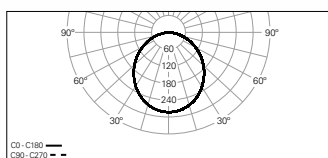

2. LIGHT+

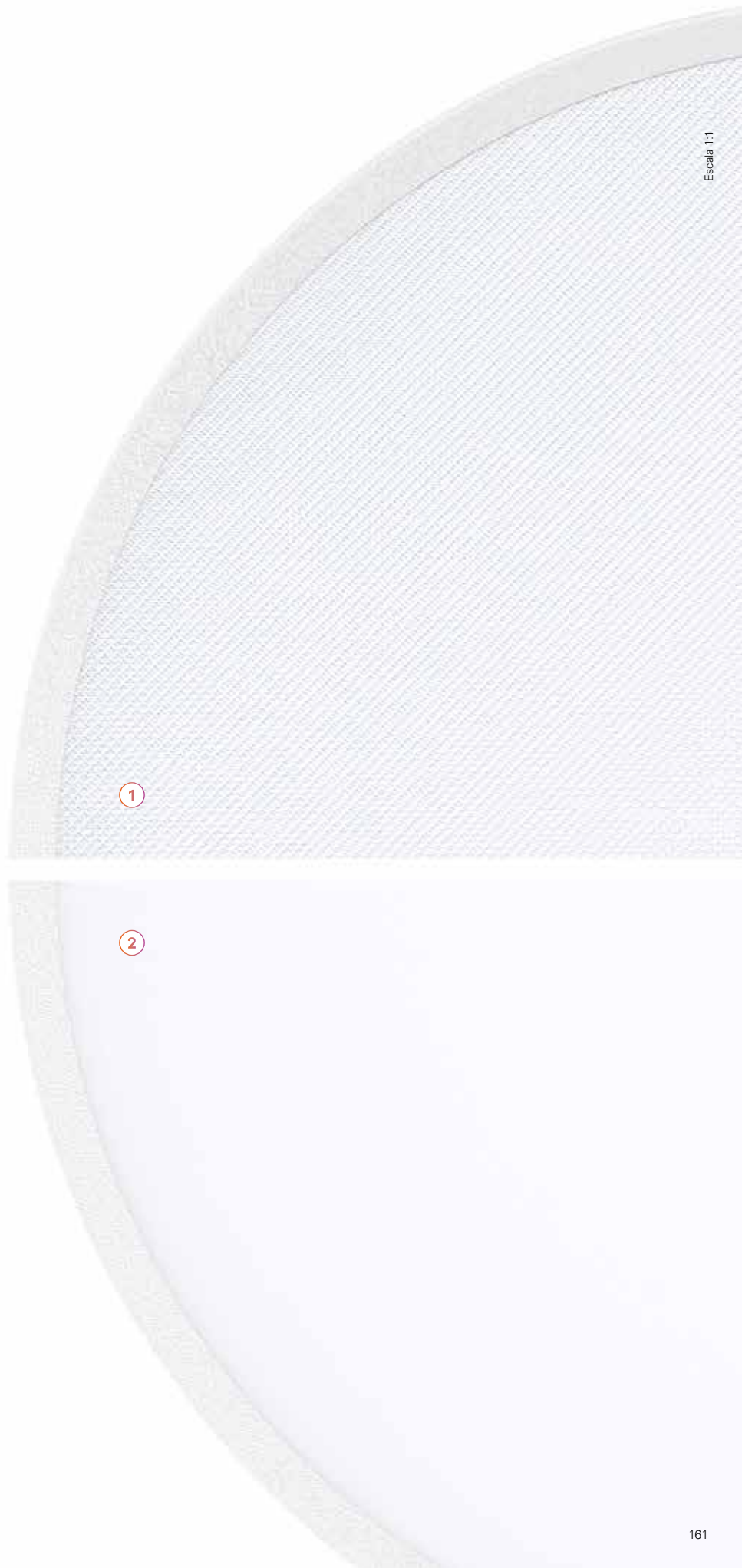
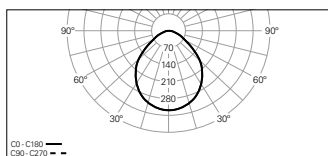

Minimalismo e tecnologia

1. Corpo

Perfil de alumínio soldado sem marcas visíveis, disponível em 12 cores.

2. LED

SDCM MacAdam ≤ 3 , temperatura de cor 3000K / 4000K, CRI > 80 e vida útil de 80.000h L90 B10.

3. Tunable White

Versões Tunable White disponíveis com um espectro de branco de 2700K até 6500K. Disponível para tamanhos a partir de $\varnothing 400$ mm.



4. gCONTROL+ ou LIGHT+

Sistema óptico de alta tecnologia com versão opalina LIGHT+ para garantir uma luz suave e uniforme ou microprismática gCONTROL+ de elevado conforto visual (UGR < 19) e sem pontos visíveis.



5. HPR

Refletor interno de alta performance para garantir elevada eficiência e uma luz suave e uniforme.

6. Luz indireta

Versão direta / indireta com 80% / 20% de proporção de luz e difusor opalino para uniformidade da luz no teto.



7. Fonte de alimentação DALI ou HF

8. Suspensões e cabo de alimentação

Graças a uma ampla variedade de suspensões e caixas de alimentação, pode optar por uma suspensão de teto muito minimalista. A suspensão central permite que a luminária se integre subtilmente em qualquer projeto. Suspensões e cabo de alimentação disponíveis com comprimento de 1500, 3000 ou 6000 mm.

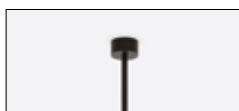

9. Caixa de alimentação

Caixas de alimentação nas versões de encastrar, saliente ou central saliente disponíveis na cor branca ou preta.



10. Kit de emergência

Kit de emergência de 3 horas. Disponível na versão de $\varnothing 600$ até $\varnothing 1150$ mm.

11. Versão IP

Índice de proteção contra água e pó IP54 disponível.



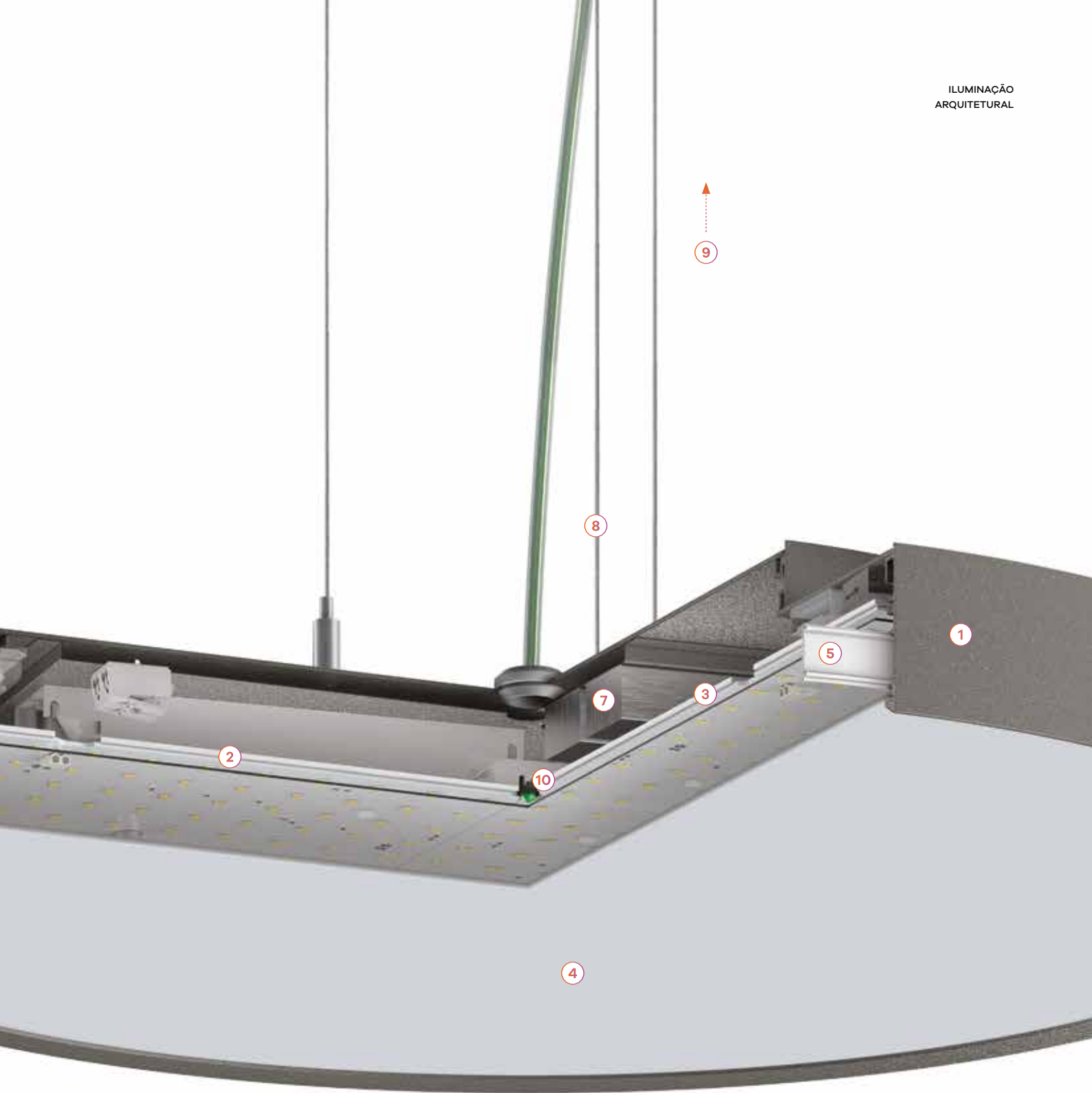

Defina a sua cor

ILUMINAÇÃO
ARQUITETURAL

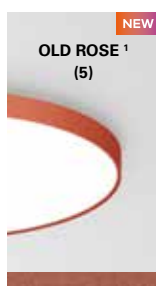
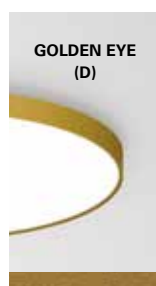
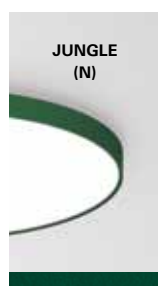
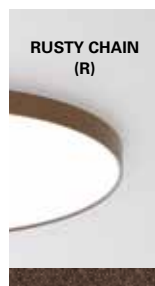
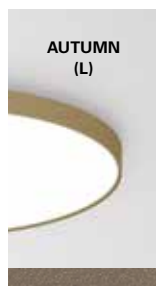
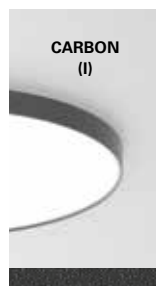
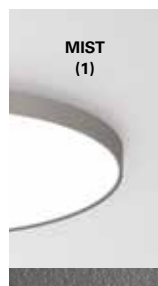
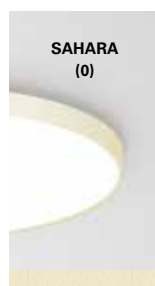
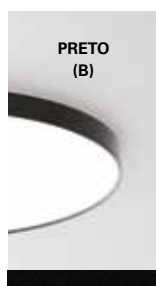
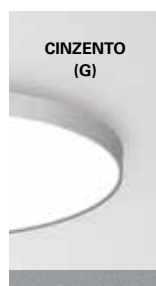
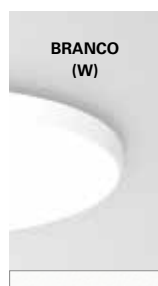



ROFY 60 /T



Características do produto

Corpo

Alumínio

Acabamento

Revestido a epóxi-poliéster

Sistema ótico

gCONTROL+ - Difusor microprismático
LIGHT+ - Difusor opalino

Fonte de luz

LED, RG1, CRI>80, MacAdam Step ≤3

Vida útil LED

80.000h @ L90, B10, Ta 25°C

Fonte de alimentação

Driver LED 220-240V-50/60Hz incluído

Espessura do teto

Para tetos entre 9,5-18 mm



230V/50Hz

IP 40

IK 04

650°C



01. Selecionar versão

ROFY 60 /T



gCONTROL+ - Difusor microprismático

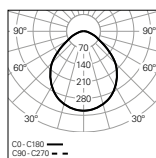

UGR	W	lm output	lm/W	Dmm	Ømm	Ømm	CÓDIGO*
≤22	16	1945	122	Ø300	Ø331	Ø331	90559L300▼▲◆000
≤22	24	3085	129	Ø400	Ø427	Ø427	90559L400▼▲◆000
≤19	43	5939	138	Ø600	Ø630	Ø630	90559L600▼▲◆000
≤19	65	8844	136	Ø900	Ø927	Ø927	90559L900▼▲◆000
≤19	107	14432	135	Ø1150	Ø1179	Ø1179	90559L115▼▲◆000

LIGHT+ - Difusor opalino

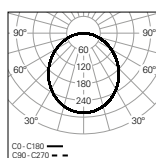

UGR	W	lm output	lm/W	Dmm	Ømm	Ømm	CÓDIGO*
≤22	16	2135	133	Ø300	Ø331	Ø331	90561L300▼▲◆000
≤25	24	3385	141	Ø400	Ø427	Ø427	90561L400▼▲◆000
≤22	43	6516	152	Ø600	Ø630	Ø630	90561L600▼▲◆000
≤22	65	9704	149	Ø900	Ø927	Ø927	90561L900▼▲◆000
≤22	107	15835	148	Ø1150	Ø1179	Ø1179	90561L115▼▲◆000

ROFY 60 /T

• Este produto não permite aplicação na parede.



*Substitua os símbolos para completar o código

Fonte de alimentação ▼
 HF E
 DALI H

Cor ¹ ▲
 Branco W
 Cinzento G
 Preto B
 Sahara 0
 Mist 1
 Carbon I
 Autumn L
 Rusty chain R
 Jungle N
 Golden eye D

Emergência ●
 No EM 0
 EM 3h (K3) ² 3

Temp. de Cor ◆
 3000K 3
 4000K 0
 Tunable White ³ T

02. Selecionar opções

OPÇÕES	Código
Cabo de segurança em aço L1500 mm	955000
Versão Low Output • Sob consulta.	



Detalhes do produto

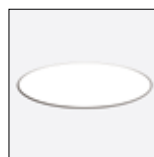

Aplicação trimless



Difusor gCONTROL+



Difusor LIGHT+

¹ Ver página 164.

² Preparado para telecomando. Apenas disponível nas versões de Ø600, Ø900 e Ø1150 mm.

³ Não disponível nas versões Ø300 mm.

ROFY 60 /T D/I



Características do produto

Corpo

Alumínio

Acabamento

Revestido a epóxi-poliéster

Sistema ótico

gCONTROL+ - Difusor microprismático
LIGHT+ - Difusor opalino

Fonte de luz

LED, RG1, CRI>80, MacAdam Step ≤3

Vida útil LED

80.000h @ L90, B10, Ta 25°C

Fonte de alimentação

Driver LED 220-240V-50/60Hz incluído

Espessura do teto

Para tetos entre 9,5-18 mm



230V/50Hz

IP 40

IK 04

650°C



01. Selecionar versão

ROFY 60 /T D/I

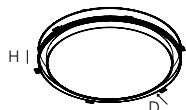

gCONTROL+ - Difusor microprismático (80%/20%)

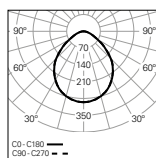

UGR	W	lm output	lm/W	Hmm	Dmm	Ø	Ø	CÓDIGO*
≤19	32	3683	115	119	Ø400	Ø523		90591L400▼▲◆0◆00
≤19	56	6869	123	119	Ø600	Ø723		90591L600▼▲◆◆◆00
≤19	84	10270	122	135	Ø900	Ø1023		90591L900▼▲◆◆◆00
≤19	137	16846	123	135	Ø1150	Ø1273		90591L115▼▲◆◆◆00

LIGHT+ - Difusor opalino (80%/20%)

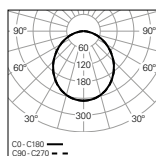

UGR	W	lm output	lm/W	Hmm	Dmm	Ø	Ø	CÓDIGO*
≤22	32	3851	120	119	Ø400	Ø523		90593L400▼▲◆0◆00
≤22	56	7182	128	119	Ø600	Ø723		90593L600▼▲◆◆◆00
≤22	84	10736	128	135	Ø900	Ø1023		90593L900▼▲◆◆◆00
≤22	137	17612	129	135	Ø1150	Ø1273		90593L115▼▲◆◆◆00

ROFY 60 /T D/I

• Este produto não permite aplicação na parede.



*Substitua os símbolos para completar o código

Fonte de alimentação ▼

HF	E
DALI	H
HF+CD ¹	Q
SWD+CD ²	Y

Cor³ ▲

□ Branco	W
■ Cinzento	G
■ Preto	B
■ Sahara	0
■ Mist	1
■ Carbon	I
■ Autumn	L
■ Rusty chain	R
■ Jungle	N
■ Golden eye	D

Emergência ●

No EM	0
EM 3h (K3) ⁴	3

Temp. de Cor ◆

3000K	3
4000K	0
Tunable White	T

02. Selecionar opções

OPÇÕES

Suporte inclinado

Ø400 mm	927100
Ø600 mm	927101
Ø900 mm	927102
Ø1150 mm	927103

Cabo de segurança em aço

L1500 mm	955000
----------	--------

Versão Low Output

• Sob consulta.



Detalhes do produto



Aplicação trimless



Suporte inclinado



Difusor gCONTROL+



Difusor LIGHT+

¹ HF + circuito duplo.

² SwitchDIM + circuito duplo.

³ Ver página 164.

⁴ Preparado para telecommando. Apenas disponível nas versões de Ø600, Ø900 e Ø1150 mm.





ROFY 60



Características do produto

Corpo

Alumínio

Acabamento

Revestido a epóxi-poliéster

Sistema ótico

gCONTROL+ - Difusor microprismático
LIGHT+ - Difusor opalino

Fonte de luz

LED, RG1, CRI>80, MacAdam Step ≤3

Vida útil LED

80.000h @ L90, B10, Ta 25°C

Fonte de alimentação

Driver LED 220-240V 50/60Hz incluído



230V/50Hz



IP 40

IK 04

650°C

01. Seleccionar versão

ROFY 60

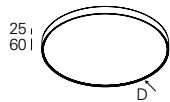

gCONTROL+ - Difusor microprismático

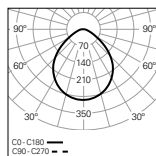

UGR	W	lm output	lm/W	Dmm	CÓDIGO*
≤22	16	1945	122	Ø300	90583L300▼▲◆0◆00
≤22	24	3085	129	Ø400	90583L400▼▲◆0◆00
≤19	43	5939	138	Ø600	90583L600▼▲◆0◆00
≤19	65	8844	136	Ø900	90583L900▼▲◆0◆00
≤19	107	14432	135	Ø1150	90583L115▼▲◆0◆00

LIGHT+ - Difusor opalino

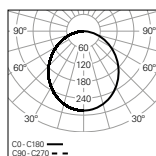

UGR	W	lm output	lm/W	Dmm	CÓDIGO*
≤22	16	2135	133	Ø300	90585L300▼▲◆0◆00
≤25	24	3385	141	Ø400	90585L400▼▲◆0◆00
≤22	43	6516	152	Ø600	90585L600▼▲◆0◆00
≤22	65	9704	149	Ø900	90585L900▼▲◆0◆00
≤22	107	15835	148	Ø1150	90585L115▼▲◆0◆00

ROFY 60

- Para versão suspensa é necessário encomendar suspensão, cabo e caixa de alimentação em separado.



*Substitua os símbolos para completar o código

Fonte de alimentação	
HF	E
DALI	H

Cor ¹	
□ Branco	W
■ Cinzento	G
■ Preto	B
■ Sahara	0
■ Mist	1
■ Carbon	I
■ Autumn	L
■ Rusty chain	R
■ Jungle	N
■ Golden eye	D
■ Old rose	5
■ Copper	7

Emergência	
No EM	0
EM 3h (K3) ²	3

Temp. de Cor	
3000K	3
4000K	0
Tunable White ³	T

¹ Ver página 164.

² Preparado para telecomando. Apenas disponível nas versões de Ø600, Ø900 e Ø1150 mm.

³ Não disponível na versão de Ø300 mm.

02. Selecionar opções

OPÇÕES

OPÇÕES	Código*
Suspensão	
S10 L1500 mm (x3)	9111001
S10 L3000 mm (x3)	9111002
S10 L6000 mm (x3)	9111003

Cabo de alimentação transparente	
L1500 mm - 3 x 0,75 mm ²	940400
L1500 mm - 5 x 0,75 mm ²	940500
L1500 mm - 7 x 0,75 mm ²	940600
L3000 mm - 3 x 0,75 mm ²	940401
L3000 mm - 5 x 0,75 mm ²	940501
L3000 mm - 7 x 0,75 mm ²	940601
L6000 mm - 3 x 0,75 mm ²	940402
L6000 mm - 5 x 0,75 mm ²	940507
L6000 mm - 7 x 0,75 mm ²	940602

• Para a versão DALI com kit de emergência e telecomando é necessário encomendar 2 cabos de alimentação 5 x 0,75 mm².

Caixa de alimentação circular				
Saliente T24	45 l		Ø95	978600♣
Saliente T26 (DALI+K3)				978601♣
Encastrar T5	33 l		Ø90	971300♣
Encastrar T27 (DALI+K3)				978700♣

Caixa de alimentação central				
Saliente T21	45 l		Ø95	977211♣
Saliente T28 (DALI+K3)				977230♣

Suspensão em haste ¹	
D95 - Ø400, Ø600 mm	913000♣
D120 - Ø900, Ø1150 mm	913010♣

• Caixa de alimentação incluída.

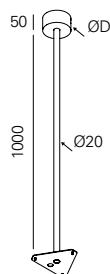

Versão Low Output

• Sob consulta.



*Substitua os símbolos para completar o código

Cor	
<input type="checkbox"/> Branco	W
<input checked="" type="checkbox"/> Preto	B



Detalhes do produto

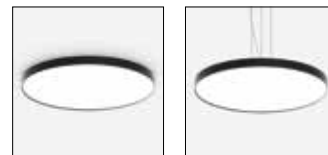

Aplicação saliente

Aplicação suspensa

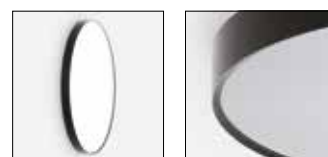

Aplicação de parede

Difusor gCONTROL+



Difusor LIGHT+

Suspensão paralela exterior



Suspensão paralela interior

Suspensão central exterior



Suspensão central interior

Suspensão em haste interior

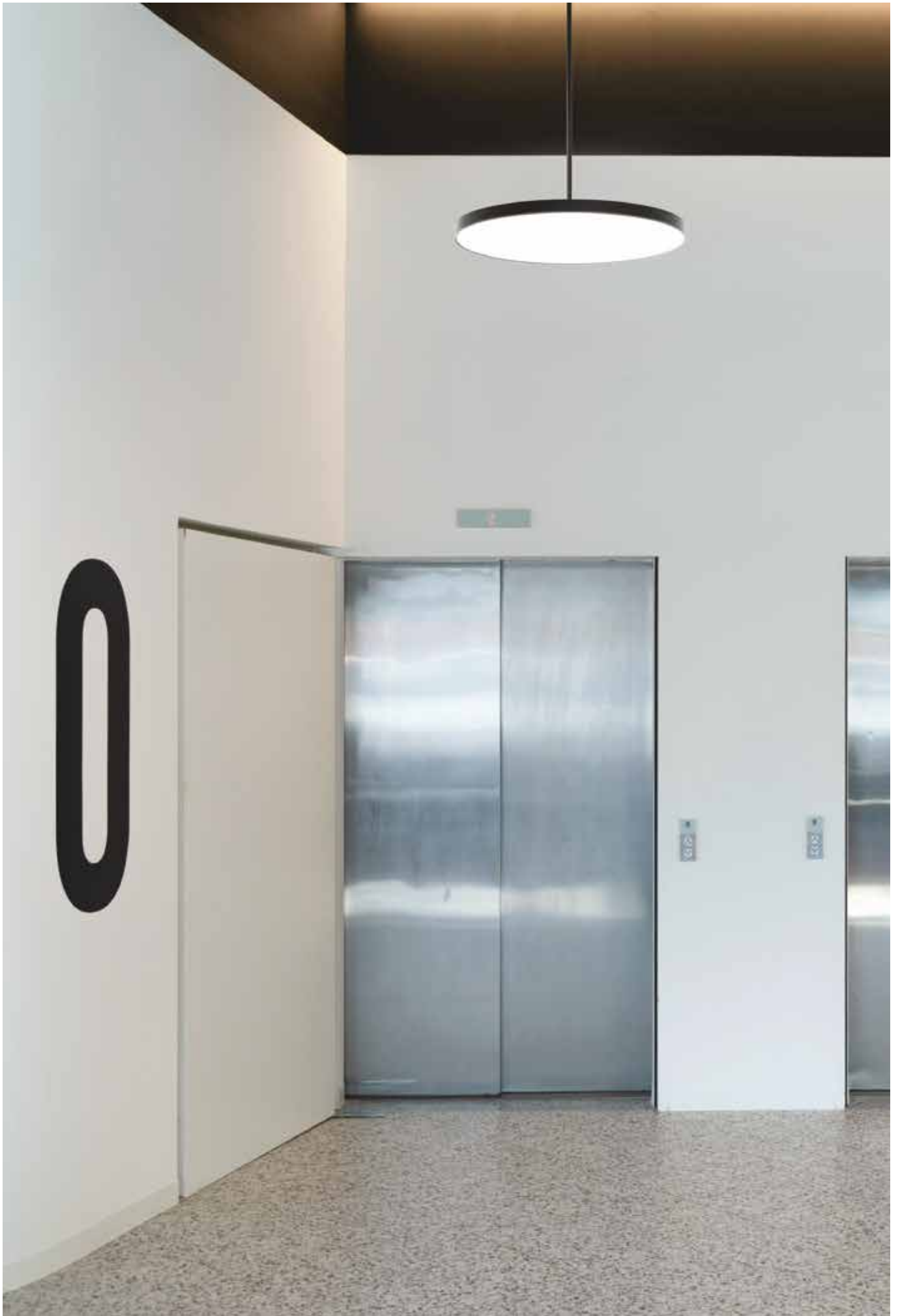

ROFY 60 D/I



Características do produto

Corpo

Alumínio

Acabamento

Revestido a epóxi-poliéster

Sistema ótico

gCONTROL+ - Difusor microprismático
LIGHT+ - Difusor opalino

Fonte de luz

LED, RG1, CRI>80, MacAdam Step ≤3

Vida útil LED

80.000h @ L90, B10, Ta 25°C

Fonte de alimentação

Driver LED 220-240V 50/60Hz incluído



230V/50Hz



IP 40

IK 04

650°C

01. Seleccionar versão

ROFY 60 D/I

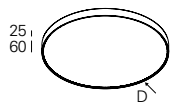

gCONTROL+ - Difusor microprismático (80%/20%)

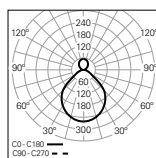

UGR	W	lm output	lm/W	Dmm	CÓDIGO*
≤19	32	3907	122	Ø400	90587L400▼▲◆0◆00
≤19	56	7286	130	Ø600	90587L600▼▲◆0◆00
≤19	84	10892	130	Ø900	90587L900▼▲◆0◆00
≤19	137	17867	130	Ø1150	90587L115▼▲◆0◆00

LIGHT+ - Difusor opalino (80%/20%)

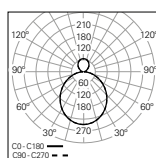

UGR	W	lm output	lm/W	Dmm	CÓDIGO*
≤22	32	4242	133	Ø400	90589L400▼▲◆0◆00
≤22	56	7910	141	Ø600	90589L600▼▲◆0◆00
≤22	84	11826	141	Ø900	90589L900▼▲◆0◆00
≤22	137	19398	142	Ø1150	90589L115▼▲◆0◆00

ROFY 60 D/I

- Para versão suspensa é necessário encomendar suspensão, cabo e caixa de alimentação em separado.
- De forma a garantir uma total uniformidade de luz no teto na versão suspensa, a instalação deverá ser feita a uma distância mínima de 500 mm.



*Substitua os símbolos para completar o código

Fonte de alimentação	
HF	E
DALI	H
HF+CD ¹	Q
SWD+CD ²	Y

Cor ³	
□ Branco	W
■ Cinzento	G
■ Preto	B
■ Sahara	0
■ Mist	1
■ Carbon	I
■ Autumn	L
■ Rusty chain	R
■ Jungle	N
■ Golden eye	D
■ Old rose	5
■ Copper	7

Emergência	
No EM	0
EM 3h (K3) ⁴	3

Temp. de Cor	
3000K	3
4000K	0
Tunable White	T

¹ HF + circuito duplo.

² SwitchDIM + circuito duplo.

³ Ver página 164.

⁴ Preparado para telecomando. Apenas disponível nas versões de Ø600, Ø900 e Ø1150 mm.



02. Selecionar opções

OPÇÕES

OPÇÕES	Código*
Suspensão	
S10 L1500 mm (x3)	9111001
S10 L3000 mm (x3)	9111002
S10 L6000 mm (x3)	9111003

Cabo de alimentação transparente	
L1500 mm - 3 x 0,75 mm ²	940400
L1500 mm - 5 x 0,75 mm ²	940500
L1500 mm - 7 x 0,75 mm ²	940600
L3000 mm - 3 x 0,75 mm ²	940401
L3000 mm - 5 x 0,75 mm ²	940501
L3000 mm - 7 x 0,75 mm ²	940601
L6000 mm - 3 x 0,75 mm ²	940402
L6000 mm - 5 x 0,75 mm ²	940507
L6000 mm - 7 x 0,75 mm ²	940602

• Para a versão DALI com kit de emergência e telecomando é necessário encomendar 2 cabos de alimentação 5 x 0,75 mm².

Caixa de alimentação circular			
Saliente T24	45 l		Ø95
Saliente T26 (DALI+K3)			978600♣
			978601♣
Encastrar T5	Ø70	33 l	
Encastrar T27 (DALI+K3)			971300♣
			978700♣

Caixa de alimentação central			
Saliente T21	45 l		Ø95
Saliente T28 (DALI+K3)			977211♣
			977230♣

Suspensão em haste	
D95 - Ø400, Ø600 mm	913000♣
D120 - Ø900, Ø1150 mm	913010♣

• Caixa de alimentação incluída.

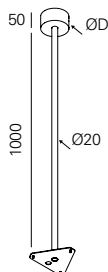

Versão Low Output

• Sob consulta.



*Substitua os símbolos para completar o código

Cor	
<input type="checkbox"/> Branco	W
<input checked="" type="checkbox"/> Preto	B



Detalhes do produto

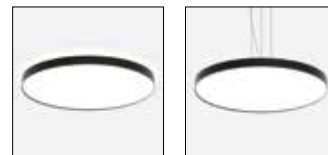

Aplicação saliente

Aplicação suspensa

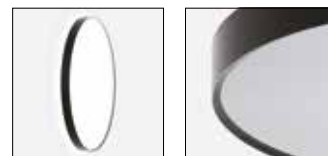

Aplicação de parede

Difusor gCONTROL+



Difusor LIGHT+

Luz indireta



Suspensão paralela exterior

Suspensão paralela interior



Suspensão central exterior

Suspensão central interior



Suspensão em haste

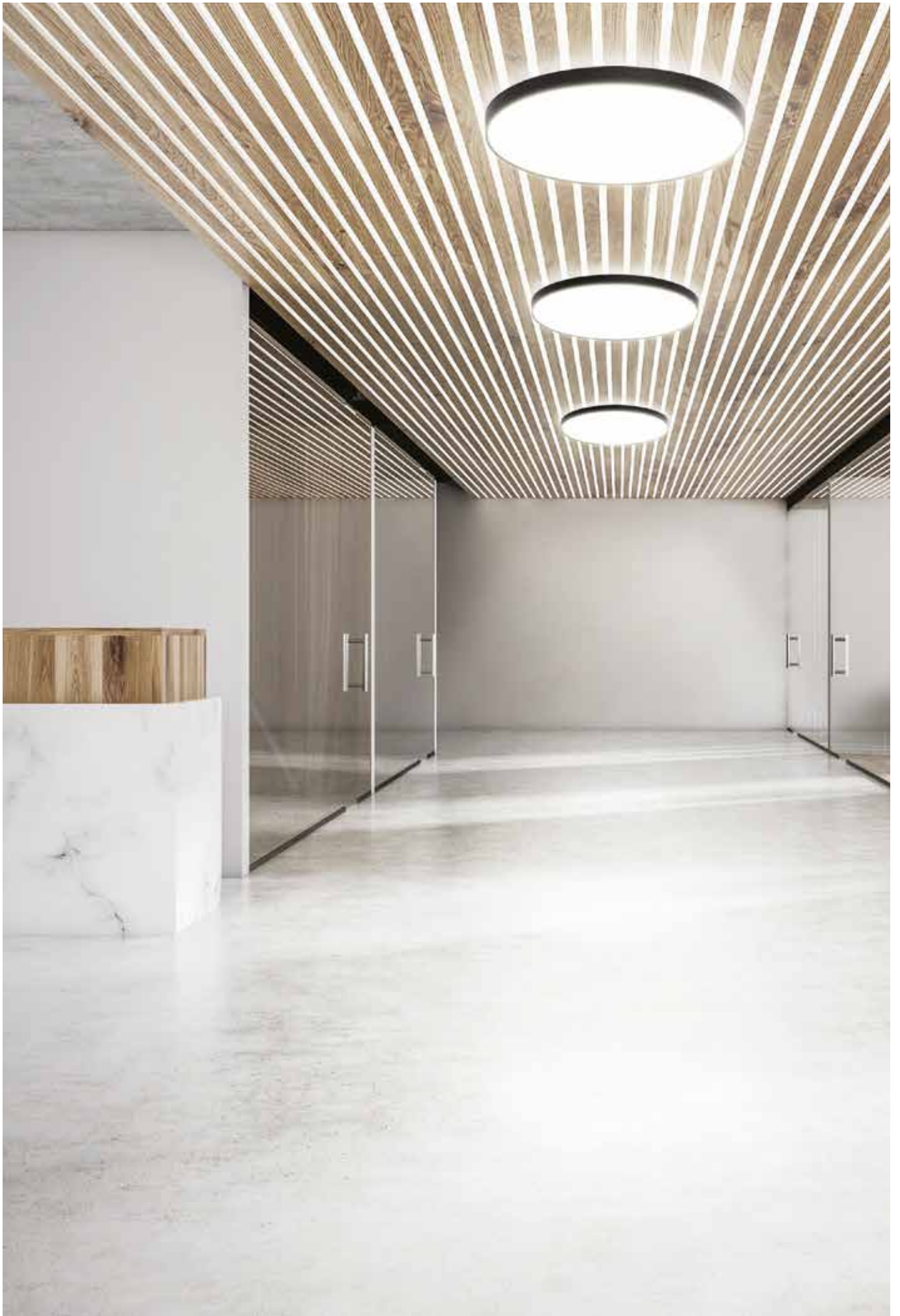

ROFY 85 /E



Características do produto

Corpo

Alumínio

Acabamento

Revestido a epóxi-poliéster

Sistema ótico

gCONTROL+ - Difusor microprismático
LIGHT+ - Difusor opalino

Fonte de luz

LED, RG1, CRI>80, MacAdam Step ≤3

Vida útil LED

80.000h @ L90, B10, Ta 25°C

Fonte de alimentação

Driver LED 220-240V-50/60Hz incluído

Espessura do teto

Para tetos entre 1-25 mm

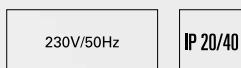

01. Selecionar versão

ROFY 85 /E



gCONTROL+ - Difusor microprismático

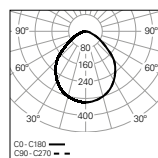

UGR	W	lm output	lm/W	Dmm	Ømm	Ømm	CÓDIGO*
≤19	16	1810	113	Ø300	Ø286		90622L300▼▲◆0◆00
≤19	24	2871	120	Ø400	Ø386		90622L400▼▲◆0◆00
≤19	43	5526	129	Ø600	Ø586		90622L600▼▲◆0◆00
≤19	65	8230	127	Ø900	Ø886		90622L900▼▲◆0◆00
≤19	107	13429	126	Ø1150	Ø1136		90622L115▼▲◆0◆00

LIGHT+ - Difusor opalino

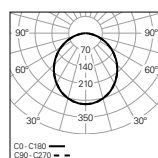

UGR	W	lm output	lm/W	Dmm	Ømm	Ømm	CÓDIGO*
≤25	16	2135	133	Ø300	Ø286		90621L300▼▲◆0◆00
≤25	24	3385	141	Ø400	Ø386		90621L400▼▲◆0◆00
≤22	43	6516	152	Ø600	Ø586		90621L600▼▲◆0◆00
≤22	65	9704	149	Ø900	Ø886		90621L900▼▲◆0◆00
≤22	107	15835	148	Ø1150	Ø1136		90621L115▼▲◆0◆00

ROFY 85 /E

• Este produto não permite aplicação na parede.



*Substitua os símbolos para completar o código

Fonte de alimentação ▼
 HF E
 DALI H

Cor ¹ ▲
 Branco W
 Cinzento G
 Preto B
 Sahara 0
 Mist 1
 Carbon I
 Autumn L
 Rusty chain R
 Jungle N
 Golden eye D

Emergência ●
 No EM 0
 EM 3h (K3) ² 3

Temp. de Cor ◆
 3000K 3
 4000K 0
 Tunable White ³ T

02. Selecionar opções

OPÇÕES Código

Cabo de segurança em aço 955000

Versão Low Output

• Sob consulta.



Detalhes do produto

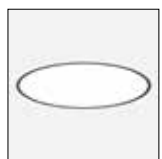

Aplicação de encastrar



Difusor gCONTROL+



Difusor LIGHT+

¹ Ver página 164.

² Preparado para telecomando. Apenas disponível nas versões de Ø600, Ø900 e Ø1150 mm.

³ Não disponível na versão de Ø300 mm.

ROFY 85



Características do produto

Corpo

Alumínio

Acabamento

Revestido a epóxi-poliéster

Sistema ótico

gCONTROL+ - Difusor microprismático
LIGHT+ - Difusor opalino

Fonte de luz

LED, RG1, CRI>80, MacAdam Step ≤3

Vida útil LED

80.000h @ L90, B10, Ta 25°C

Fonte de alimentação

Driver LED 220-240V-50/60Hz incluído



230V/50Hz



IP 40

IK 04

650°C

01. Seleccionar versão

ROFY 85

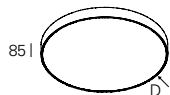

gCONTROL+ - Difusor microprismático

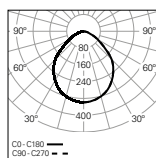

UGR	W	lm output	lm/W	Dmm	CÓDIGO*
≤22	16	1999	125	Ø300	90620L300▼▲◆00
≤22	24	3171	132	Ø400	90620L400▼▲◆00
≤19	43	6104	142	Ø600	90620L600▼▲◆00
≤19	65	9090	140	Ø900	90620L900▼▲◆00
≤19	107	14833	139	Ø1150	90620L115▼▲◆00

LIGHT+ - Difusor opalino

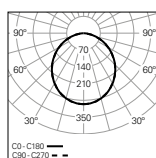

UGR	W	lm output	lm/W	Dmm	CÓDIGO*
≤25	16	2162	135	Ø300	90619L300▼▲◆00
≤25	24	3428	143	Ø400	90619L400▼▲◆00
≤22	43	6598	153	Ø600	90619L600▼▲◆00
≤22	65	9827	151	Ø900	90619L900▼▲◆00
≤22	107	16035	150	Ø1150	90619L115▼▲◆00

ROFY 85

- Para versão suspensa é necessário encomendar suspensão, cabo e caixa de alimentação em separado.



*Substitua os símbolos para completar o código

Fonte de alimentação ▼

HF E

DALI H

Cor ¹ ▲

□ Branco W

■ Cinzento G

■ Preto B

■ Sahara 0

■ Mist 1

■ Carbon I

■ Autumn L

■ Rusty chain R

■ Jungle N

■ Golden eye D

Emergência ●

No EM 0

EM 3h (K3) ² 3

Temp. de Cor ◆

3000K 3

4000K 0

Tunable White ³ T

¹ Ver página 164.

² Preparado para telecomando. Apenas disponível nas versões de Ø600, Ø900 e Ø1150 mm.

³ Não disponível na versão de Ø300 mm.

02. Selecionar opções

OPÇÕES

OPÇÕES	Código*
Suspensão	
S10 L1500 mm (x3)	9111001
S10 L3000 mm (x3)	9111002
S10 L6000 mm (x3)	9111003

Cabo de alimentação transparente	
L1500 mm - 3 x 0,75 mm ²	940400
L1500 mm - 5 x 0,75 mm ²	940500
L1500 mm - 7 x 0,75 mm ²	940600
L3000 mm - 3 x 0,75 mm ²	940401
L3000 mm - 5 x 0,75 mm ²	940501
L3000 mm - 7 x 0,75 mm ²	940601
L6000 mm - 3 x 0,75 mm ²	940402
L6000 mm - 5 x 0,75 mm ²	940507
L6000 mm - 7 x 0,75 mm ²	940602

• Para a versão DALI com kit de emergência e telecomando é necessário encomendar 2 cabos de alimentação 5 x 0,75 mm².

Caixa de alimentação circular				
Saliente T24	45 l		Ø95	978600♣
Saliente T26 (DALI+K3)				978601♣
Encastrar T5	33 l		Ø90	971300♣
Encastrar T27 (DALI+K3)				978700♣

Caixa de alimentação central				
Saliente T21	45 l		Ø95	977211♣
Saliente T28 (DALI+K3)				977230♣

Suspensão em haste	
D95 - Ø400, Ø600 mm	913000♣
D120 - Ø900, Ø1150 mm	913010♣

• Caixa de alimentação incluída.

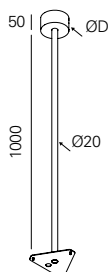

Versão Low Output

• Sob consulta.



*Substitua os símbolos para completar o código

Cor	
<input type="checkbox"/> Branco	W
<input checked="" type="checkbox"/> Preto	B



Detalhes do produto

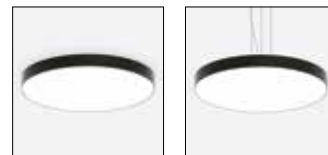

Aplicação saliente

Aplicação suspensa



Aplicação de parede

Difusor gCONTROL+



Difusor LIGHT+

Suspensão paralela exterior



Suspensão paralela interior

Suspensão central exterior



Suspensão central interior

Suspensão em haste



ROFY 85 D/I



Características do produto

Corpo

Alumínio

Acabamento

Revestido a epóxi-poliéster

Sistema ótico

gCONTROL+ - Difusor microprismático
LIGHT+ - Difusor opalino

Fonte de luz

LED, RG1, CRI>80, MacAdam Step ≤3

Vida útil LED

80.000h @ L90, B10, Ta 25°C

Fonte de alimentação

Driver LED 220-240V-50/60Hz incluído



230V/50Hz



IP 40

IK 04

650°C

01. Selecionar versão

ROFY 85 D/I

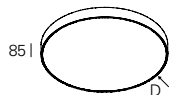

gCONTROL+ - Difusor microprismático (80%/20%)

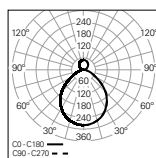

UGR	W	lm output	lm/W	Dmm	CÓDIGO*
≤19	32	4018	126	Ø400	90624L400♥♣♦00
≤19	56	7494	134	Ø600	90624L600♥♣♦♦00
≤19	84	11203	133	Ø900	90624L900♥♣♦♦00
≤19	137	18377	134	Ø1150	90624L115♥♣♦♦00

LIGHT+ - Difusor opalino (80%/20%)

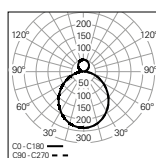

UGR	W	lm output	lm/W	Dmm	CÓDIGO*
≤22	32	4242	133	Ø400	90623L400♥♣♦♦00
≤22	56	7910	141	Ø600	90623L600♥♣♦♦00
≤22	84	11826	141	Ø900	90623L900♥♣♦♦00
≤22	137	19398	142	Ø1150	90623L115♥♣♦♦00

ROFY 85 D/I

- Para completar o produto é necessário encomendar suspensão, cabo e caixa de alimentação em separado.
- De forma a garantir uma total uniformidade de luz no teto, a instalação deverá ser feita a uma distância mínima de 500 mm.



*Substitua os símbolos para completar o código

Fonte de alimentação ▼

HF	E
DALI	H
HF+CD ¹	Q
SWD+CD ²	Y

Cor³ ♣

□ Branco	W
■ Cinzento	G
■ Preto	B
■ Sahara	0
■ Mist	1
■ Carbon	I
■ Autumn	L
■ Rusty chain	R
■ Jungle	N
■ Golden eye	D

Emergência ●

No EM	0
EM 3h (K3) ⁴	3

Temp. de Cor ♦

3000K	3
4000K	0
Tunable White	T



¹ HF + circuito duplo.

² SwitchDIM + circuito duplo.

³ Ver página 164.

⁴ Preparado para telecomando. Apenas disponível nas versões de Ø600, Ø900 e Ø1150 mm.

02. Selecionar opções

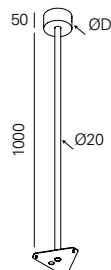
OPÇÕES	Código*
Suspensão	
S10 L1500 mm (x3)	9111001
S10 L3000 mm (x3)	9111002
S10 L6000 mm (x3)	9111003
Cabo de alimentação transparente	
L1500 mm - 3 x 0,75 mm ²	940400
L1500 mm - 5 x 0,75 mm ²	940500
L1500 mm - 7 x 0,75 mm ²	940600
L3000 mm - 3 x 0,75 mm ²	940401
L3000 mm - 5 x 0,75 mm ²	940501
L3000 mm - 7 x 0,75 mm ²	940601
L6000 mm - 3 x 0,75 mm ²	940402
L6000 mm - 5 x 0,75 mm ²	940507
L6000 mm - 7 x 0,75 mm ²	940602
<ul style="list-style-type: none"> • Para a versão DALI com kit de emergência e telecomando é necessário encomendar 2 cabos de alimentação 5 x 0,75 mm². 	
Caixa de alimentação circular	
Saliente T24  Ø95	45 l 978600♣
Saliente T26 (DALI+K3)	978601♣
Encastrar T5  Ø70 33 l	971300♣
Encastrar T27 (DALI+K3)	978700♣
Caixa de alimentação central	
Saliente T21  Ø95	45 l 977211♣
Saliente T28 (DALI+K3)	977230♣
Suspensão em haste	
D95 - Ø400, Ø600 mm	913000♣
D120 - Ø900, Ø1150 mm	913010♣
<ul style="list-style-type: none"> • Caixa de alimentação incluída. 	
	
Versão Low Output	
<ul style="list-style-type: none"> • Sob consulta. 	



*Substitua os símbolos para completar o código

Cor

<input type="checkbox"/> Branco	W
<input checked="" type="checkbox"/> Preto	B



Detalhes do produto



Aplicação suspensa

Luz indireta



Difusor gCONTROL+

Difusor LIGHT+



Suspensão paralela exterior

Suspensão paralela interior



Suspensão central exterior

Suspensão central interior



Suspensão em haste

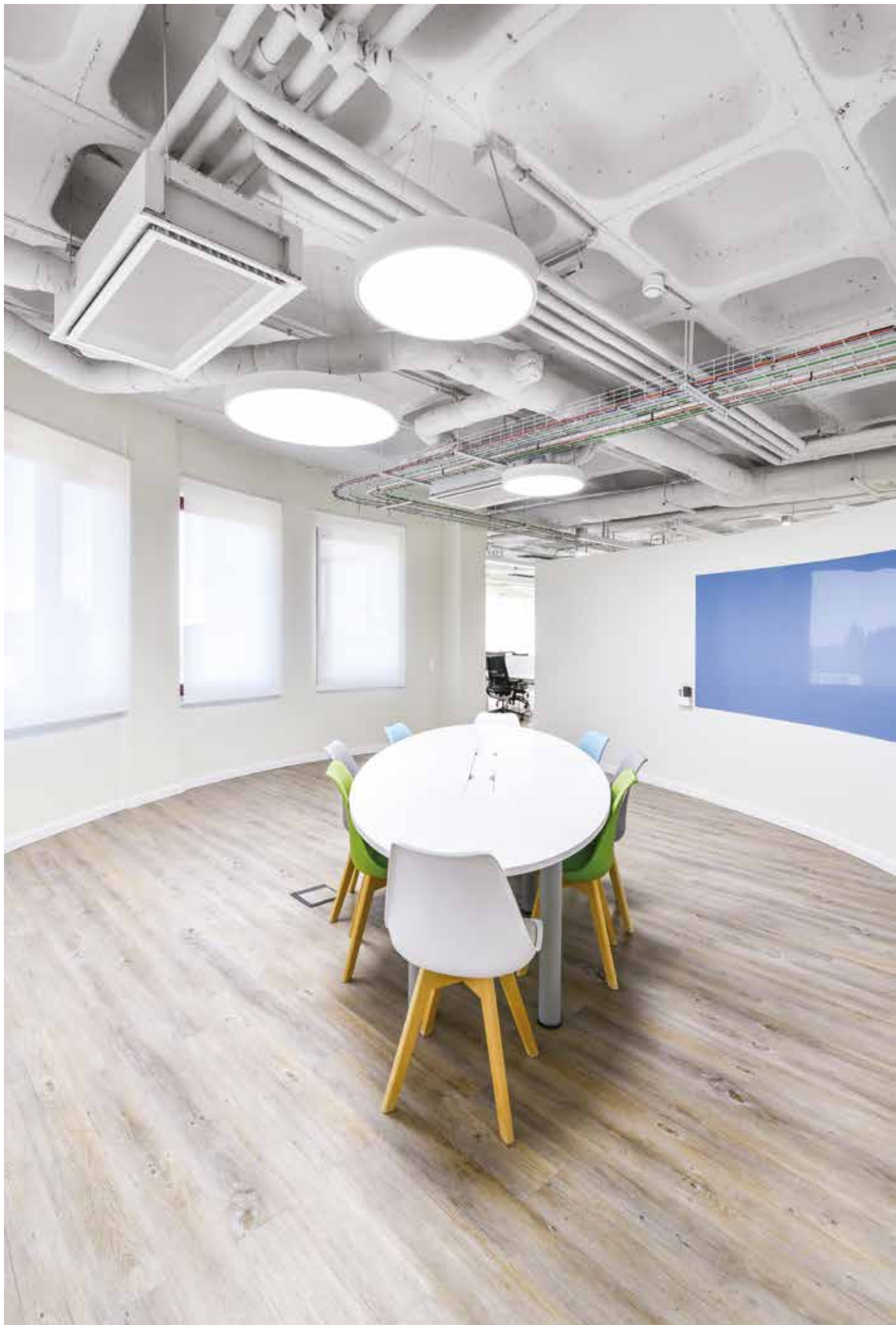

ROFY 85 IP /E



Características do produto

Corpo

Alumínio

Acabamento

Revestido a epóxi-poliéster

Sistema ótico

LIGHT+ - Difusor opalino

Fonte de luz

LED, RG1, CRI>80, MacAdam Step ≤3

Vida útil LED

80.000h @ L90, B10, Ta 25°C

Fonte de alimentação

Driver LED 220-240V-50/60Hz incluído

Espessura do teto

Para tetos entre 1-35 mm

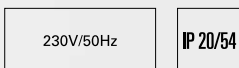

01. Selecionar versão

ROFY 85 IP / E

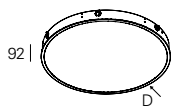

LIGHT+ - Difusor opalino

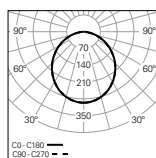

W	lm output	lm/W	Dmm	Ø	CÓDIGO*
16	2135	133	Ø323	Ø305	90573L300▼▲◆0◆00
24	3385	141	Ø423	Ø405	90573L400▼▲◆0◆00
43	6516	152	Ø623	Ø605	90573L600▼▲◆0◆00

ROFY 85 IP / E

- Este produto não permite aplicação na parede.



*Substitua os símbolos para completar o código

Fonte de alimentação	
HF	E
DALI	H

Cor ¹

□ Branco	W
■ Cinzento	G
■ Preto	B
■ Sahara	0
■ Mist	1
■ Carbon	I
■ Autumn	L
■ Rusty chain	R
■ Jungle	N
■ Golden eye	D

Emergência

No EM	0
EM 3h (K3) ²	3

Temp. de Cor

3000K	3
4000K	0
Tunable White ³	T

02. Selecionar opções

OPÇÕES Código

Cabo de segurança em aço
L1500 mm 955000

Versão Low Output

- Sob consulta.



Detalhes do produto

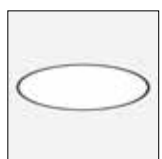

Aplicação de encastrar



Difusor LIGHT+

¹ Ver página 164.

² Preparado para telecomando. Apenas disponível na versão de Ø600 mm.

³ Não disponível nas versões Ø300 mm.

ROFY 85 IP /C



Características do produto

Corpo

Alumínio

Acabamento

Revestido a epóxi-poliéster

Sistema ótico

LIGHT+ - Difusor opalino

Fonte de luz

LED, RG1, CRI>80, MacAdam Step ≤3

Vida útil LED

80.000h @ L90, B10, Ta 25°C

Fonte de alimentação

Driver LED 220-240V-50/60Hz incluído



230V/50Hz

IP 54

IK 04

650°C



01. Selecionar versão

ROFY 85 IP /C

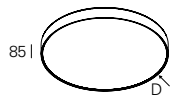

LIGHT+ - Difusor opalino

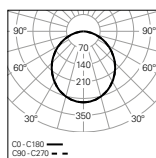

W	lm output	lm/W	Dmm	CÓDIGO*
16	2135	133	Ø300	90581L300♥♣♦00
24	3385	141	Ø400	90581L400♥♣♦00
43	6516	152	Ø600	90581L600♥♣♦00



*Substitua os símbolos para completar o código

Fonte de alimentação	
HF	E
DALI	H

Cor ¹	
□ Branco	W
■ Cinzento	G
■ Preto	B
■ Sahara	0
■ Mist	1
■ Carbon	I
■ Autumn	L
■ Rusty chain	R
■ Jungle	N
■ Golden eye	D

Emergência	
No EM	0
EM 3h (K3) ²	3

Temp. de Cor	
3000K	3
4000K	0
Tunable White ³	T

02. Selecionar opções

OPÇÕES

Versão Low Output

- Sob consulta.



Detalhes do produto



Aplicação saliente



Aplicação de parede



Difusor LIGHT+



Proteção IP54

¹ Ver página 164.

² Preparado para telecommando. Apenas disponível na versão de Ø600 mm.

³ Não disponível nas versões Ø300 mm.





RECEPTION



ROFY 60 SQ



ROFY 60 Sq
198



ROFY 60 Sq D/I
202



ROFY 60 Sq



Características do produto

Corpo

Alumínio

Acabamento

Revestido a epóxi-poliéster

Sistema ótico

gCONTROL+ - Difusor microprismático
LIGHT+ - Difusor opalino

Fonte de luz

LED, RG1, CRI>80, MacAdam Step ≤3

Vida útil LED

80.000h @ L90, B10, Ta 25°C

Fonte de alimentação

Driver LED 220-240V 50/60Hz incluído



230V/50Hz



IP 40

K 04

650°C

01. Seleccionar versão

ROFY 60 Sq

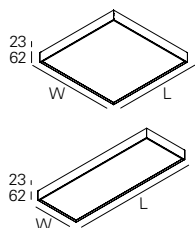

gCONTROL+ - Difusor microprismático

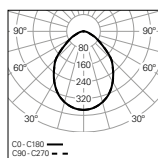

UGR	W	lm output	lm/W	LxWmm	CÓDIGO*
≤19	12	1478	123	286x286	90718L286▼▲0◆00
≤19	45	5913	131	550x550	90718L550▼▲◆◆00
≤19	25	2956	118	550x286	90718L552▼▲0◆00
≤19	36	4435	123	814x286	90718L812▼▲◆◆00
≤19	45	5913	131	1078x286	90718L102▼▲◆◆00
≤19	56	7391	132	1342x286	90718L132▼▲◆◆00

LIGHT+ - Difusor opalino

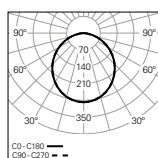

UGR	W	lm output	lm/W	LxWmm	CÓDIGO*
≤22	12	1582	132	286x286	90720L286▼▲0◆00
≤22	45	6329	141	550x550	90720L550▼▲◆◆00
≤22	25	3165	127	550x286	90720L552▼▲0◆00
≤22	36	4747	132	814x286	90720L812▼▲◆◆00
≤22	45	6329	141	1078x286	90720L102▼▲◆◆00
≤22	56	7912	141	1342x286	90720L132▼▲◆◆00

ROFY 60 Sq

• Para versão suspensa é necessário encomendar suspensão, cabo e caixa de alimentação em separado.



*Substitua os símbolos para completar o código

Fonte de alimentação ▼

HF	E
DALI	H

Cor ¹ ▲

□ Branco	W
■ Cinzento	G
■ Preto	B
■ Sahara	0
■ Mist	1
■ Carbon	I
■ Autumn	L
■ Rusty chain	R
■ Jungle	N
■ Golden eye	D

Emergência ●

No EM	0
EM 3h (K3) ²	3





Temp. de Cor ◆

3000K	3
4000K	0
Tunable White	T

¹ Ver página 164.

² Preparado para telecomando. Apenas disponível nas versões de L550x550, L814, L1078 e L1342 mm.

02. Selecionar opções

OPÇÕES	Código*
Suspensão	
S11 L1500 mm (x4)	9129041
S11 L3000 mm (x4)	9129042
S11 L6000 mm (x4)	9129043
Cabo de alimentação transparente	
L1500 mm - 3 x 0,75 mm ²	940400
L1500 mm - 5 x 0,75 mm ²	940500
L1500 mm - 7 x 0,75 mm ²	940600
L3000 mm - 3 x 0,75 mm ²	940401
L3000 mm - 5 x 0,75 mm ²	940501
L3000 mm - 7 x 0,75 mm ²	940601
L6000 mm - 3 x 0,75 mm ²	940402
L6000 mm - 5 x 0,75 mm ²	940507
L6000 mm - 7 x 0,75 mm ²	940602
<ul style="list-style-type: none"> • Para a versão DALI com kit de emergência e telecomando é necessário encomendar 2 cabos de alimentação 5 x 0,75 mm². 	
Caixa de alimentação	
Saliente T25  45  100	978610▲
Saliente T29 (DALI+K3)	978611▲
Encastrar T7  Ø70 35  90	971400▲
Encastrar T59 (DALI+K3)	971410▲
Versão Low Output	
• Sob consulta.	



*Substitua os símbolos para completar o código

Cor

<input type="checkbox"/> Branco	W
<input checked="" type="checkbox"/> Preto	B



Detalhes do produto

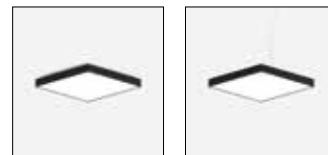

Aplicação saliente

Aplicação suspensa

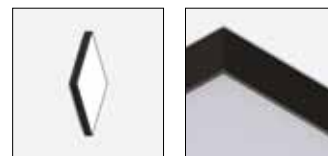

Aplicação de parede

Difusor gCONTROL+



Difusor LIGHT+

Suspensão paralela exterior



Caixas de alimentação

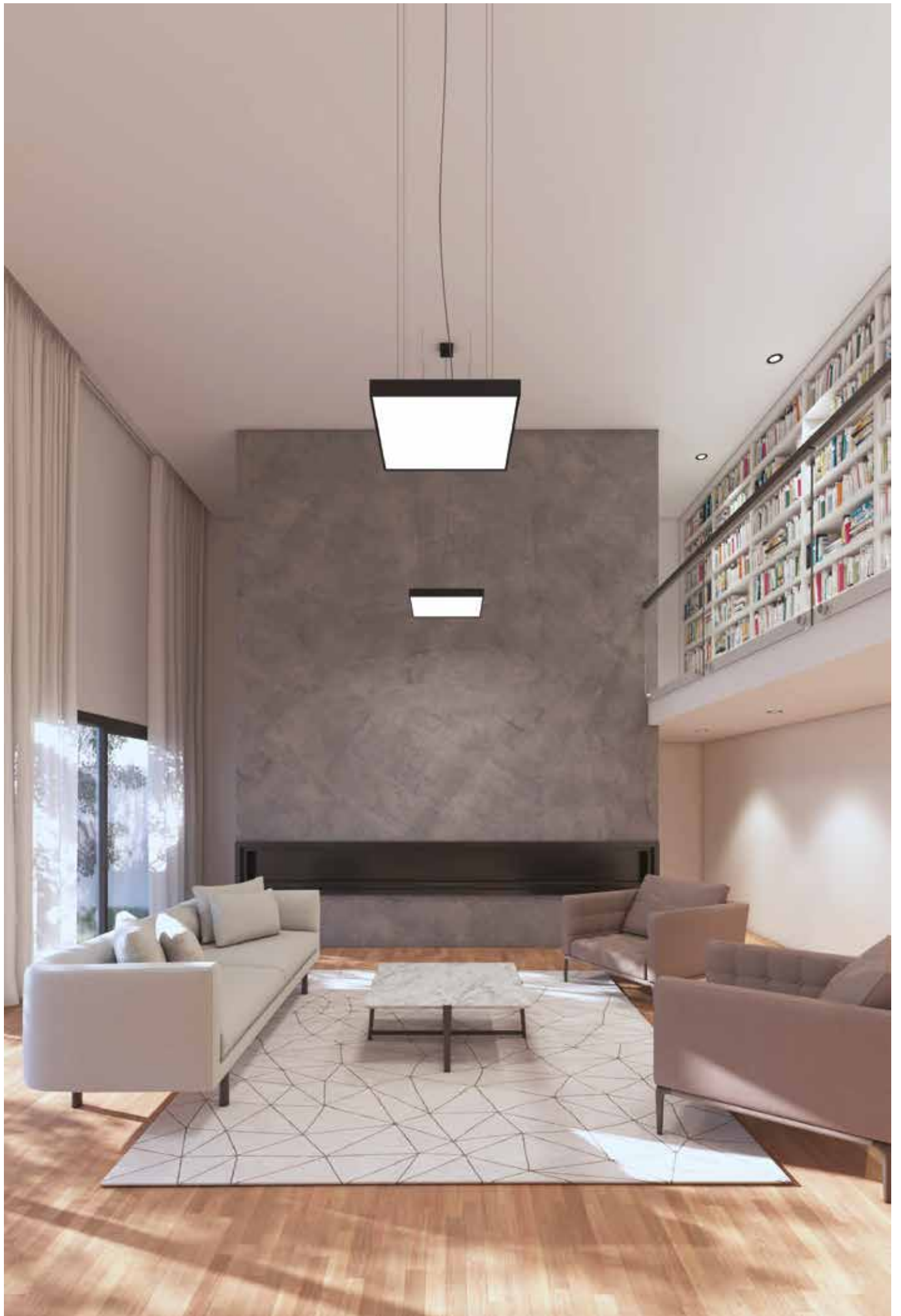

ROFY 60 Sq D/I



Características do produto

Corpo

Alumínio

Acabamento

Revestido a epóxi-poliéster

Sistema ótico

gCONTROL+ - Difusor microprismático
LIGHT+ - Difusor opalino

Fonte de luz

LED, RG1, CRI>80, MacAdam Step ≤3

Vida útil LED

80.000h @ L90, B10, Ta 25°C

Fonte de alimentação

Driver LED 220-240V 50/60Hz incluído



230V/50Hz



IP 40

IK 04

650°C

01. Selecionar versão

ROFY 60 Sq D/I

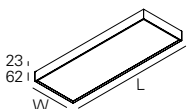
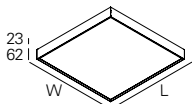

gCONTROL+ - Difusor microprismático (75%/25%)

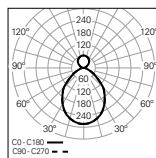

UGR	W	lm output	lm/W	LxWmm	CÓDIGO*
≤16	18	2231	124	286x286	90714L286▼▲0♦00
≤19	60	7753	129	550x550	90714L550▼▲♦♦00
≤19	33	3967	120	550x286	90714L552▼▲0♦00
≤19	48	5963	124	814x286	90714L812▼▲♦♦00
≤19	60	7935	132	1078x286	90714L102▼▲♦♦00
≤19	75	9912	132	1342x286	90714L132▼▲♦♦00

LIGHT+ - Difusor opalino (75%/25%)

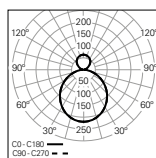

UGR	W	lm output	lm/W	LxWmm	CÓDIGO*
≤22	18	2325	129	286x286	90716L286▼▲0♦00
≤22	60	8081	135	550x550	90716L550▼▲♦♦00
≤22	33	4135	125	550x286	90716L552▼▲0♦00
≤22	48	6215	129	814x286	90716L812▼▲♦♦00
≤22	60	8270	138	1078x286	90716L102▼▲♦♦00
≤22	75	10330	138	1342x286	90716L132▼▲♦♦00

ROFY 60 Sq D/I

- Para versão suspensa é necessário encomendar suspensão, cabo e caixa de alimentação em separado.
- De forma a garantir uma total uniformidade de luz no teto na versão suspensa, a instalação deverá ser feita a uma distância mínima de 500 mm.



*Substitua os símbolos para completar o código

Fonte de alimentação ▼

HF	E
DALI	H
HF+CD ¹	Q
SWD+CD ²	Y

Cor³ ▲

□ Branco	W
■ Cinzento	G
■ Preto	B
■ Sahara	0
■ Mist	1
■ Carbon	I
■ Autumn	L
■ Rusty chain	R
■ Jungle	N
■ Golden eye	D

Emergência ●

No EM	0
EM 3h (K3) ⁴	3

Temp. de Cor ◆

3000K	3
4000K	0
Tunable White	T





¹ HF + circuito duplo.

² SwitchDIM + circuito duplo.

³ Ver página 164.

⁴ Preparado para telecommando. Apenas disponível nas versões de L550x550, L814, L1078 e L1342 mm

02. Selecionar opções

OPÇÕES	Código*
Suspensão	
S11 L1500 mm (x4)	9129041
S11 L3000 mm (x4)	9129042
S11 L6000 mm (x4)	9129043
Cabo de alimentação transparente	
L1500 mm - 3 x 0,75 mm ²	940400
L1500 mm - 5 x 0,75 mm ²	940500
L1500 mm - 7 x 0,75 mm ²	940600
L3000 mm - 3 x 0,75 mm ²	940401
L3000 mm - 5 x 0,75 mm ²	940501
L3000 mm - 7 x 0,75 mm ²	940601
L6000 mm - 3 x 0,75 mm ²	940402
L6000 mm - 5 x 0,75 mm ²	940507
L6000 mm - 7 x 0,75 mm ²	940602
<ul style="list-style-type: none"> • Para a versão DALI com kit de emergência e telecomando é necessário encomendar 2 cabos de alimentação 5 x 0,75 mm². 	
Caixa de alimentação	
Saliente T25  45  100	978610▲
Saliente T29 (DALI+K3)	978611▲
Encastrar T7  Ø70 35  90	971400▲
Encastrar T59 (DALI+K3)	971410▲
Versão Low Output	
• Sob consulta.	



*Substitua os símbolos para completar o código

Cor

<input type="checkbox"/> Branco	W
<input checked="" type="checkbox"/> Preto	B



Detalhes do produto

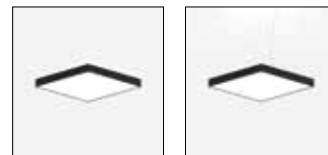

Aplicação saliente

Aplicação suspensa

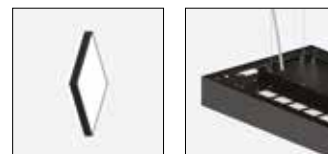

Aplicação de parede

Luz indireta

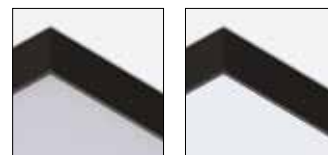

Difusor gCONTROL+

Difusor LIGHT+

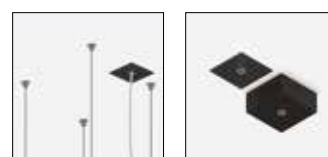

Suspensão paralela exterior

Caixas de alimentação





OREO



OREO /C
214



OREO In
216



OREO Out
220



OREO V In
224



OREO V Out
228



OREO Linea Down
232



OREO Linea Up
236



Tipos de aplicação

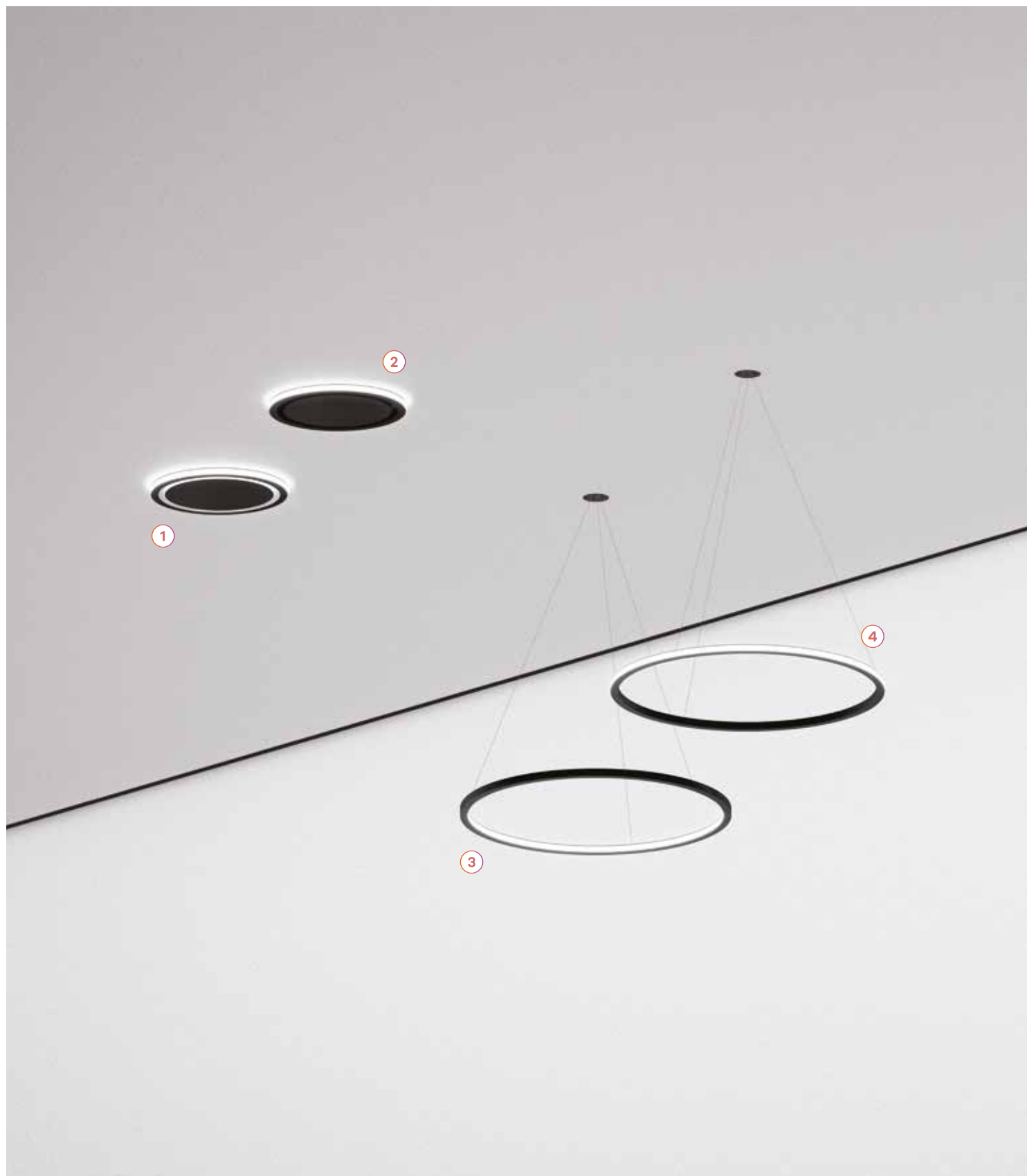

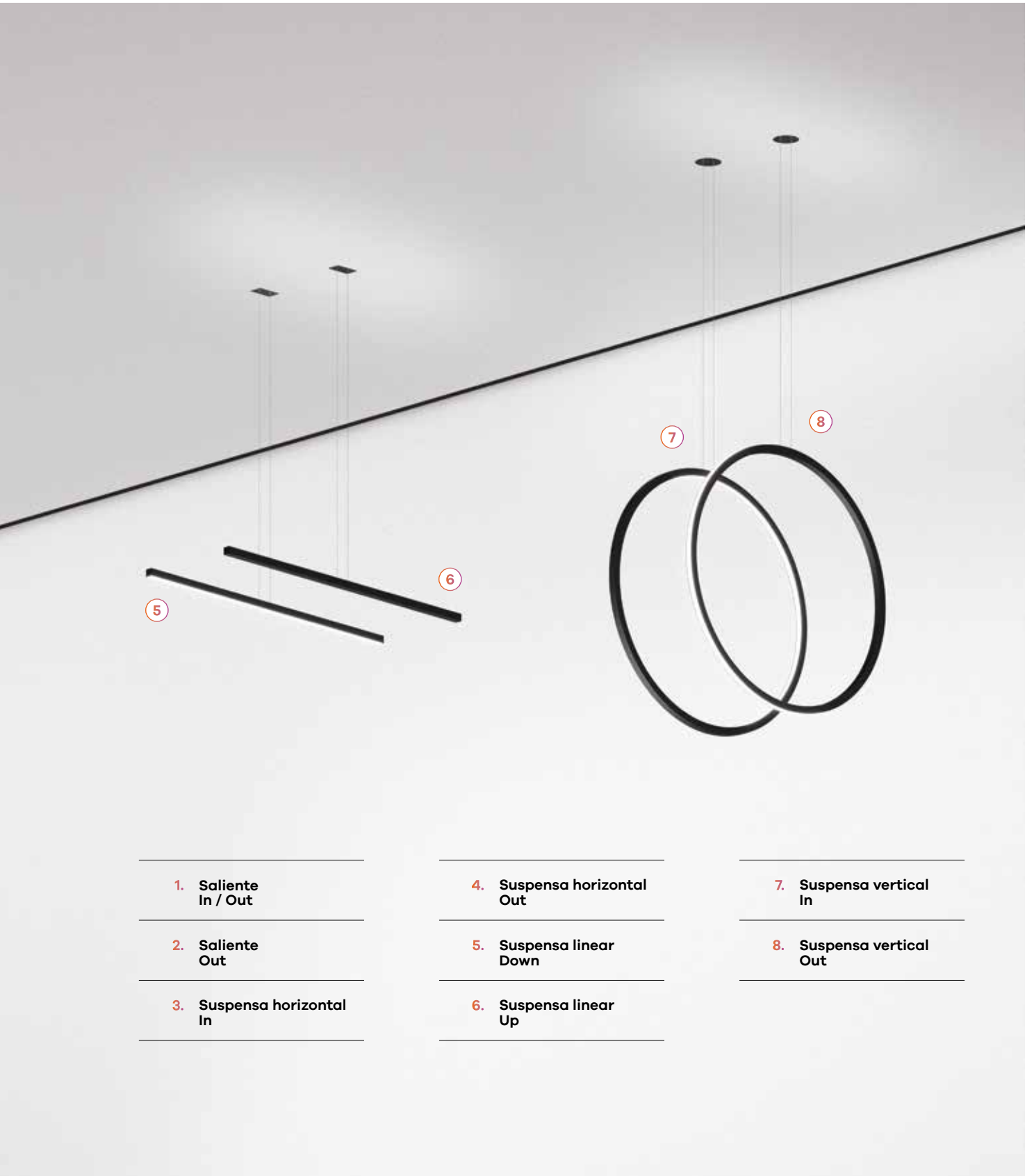

Minimalismo e tecnologia



1. OmniaControl (VOICE & APP Tuya Smart)

Através do módulo OmniaControl instalado nas luminárias e recorrendo aos dispositivos de controlo de voz da Amazon Echo, Google Home ou da App Tuya Smart, pode controlar toda a iluminação Smart LED em sua casa/escritório.

2. Corpo

Perfil de alumínio soldado sem marcas visíveis, disponível em 12 cores.

3. LED

SDCM MacAdam ≤ 3 , temperatura de cor 2700K / 3000K / 4000K, CRI > 90 e vida útil de 60.000h L80 B10.

4. Tunable White e RGB White

Versões Tunable White disponíveis com um espectro de branco de 3000K até 5700K. Versões RGB White também estão disponíveis.

5. bLINE

Sistema ótico bLINE com tecnologia clip-in que garante uma luz suave e uniforme sem pontos visíveis.

6. A suspensão é o cabo de alimentação

As suspensões de 1500 mm funcionam como cabo de alimentação, proporcionando um aspeto mais "clean" ao seu espaço.

7. Caixa de alimentação

Caixas de alimentação nas versões trimless, de encastrar ou saliente disponíveis na cor branca ou preta.

Sistema ótico

ILUMINAÇÃO
ARQUITETURAL

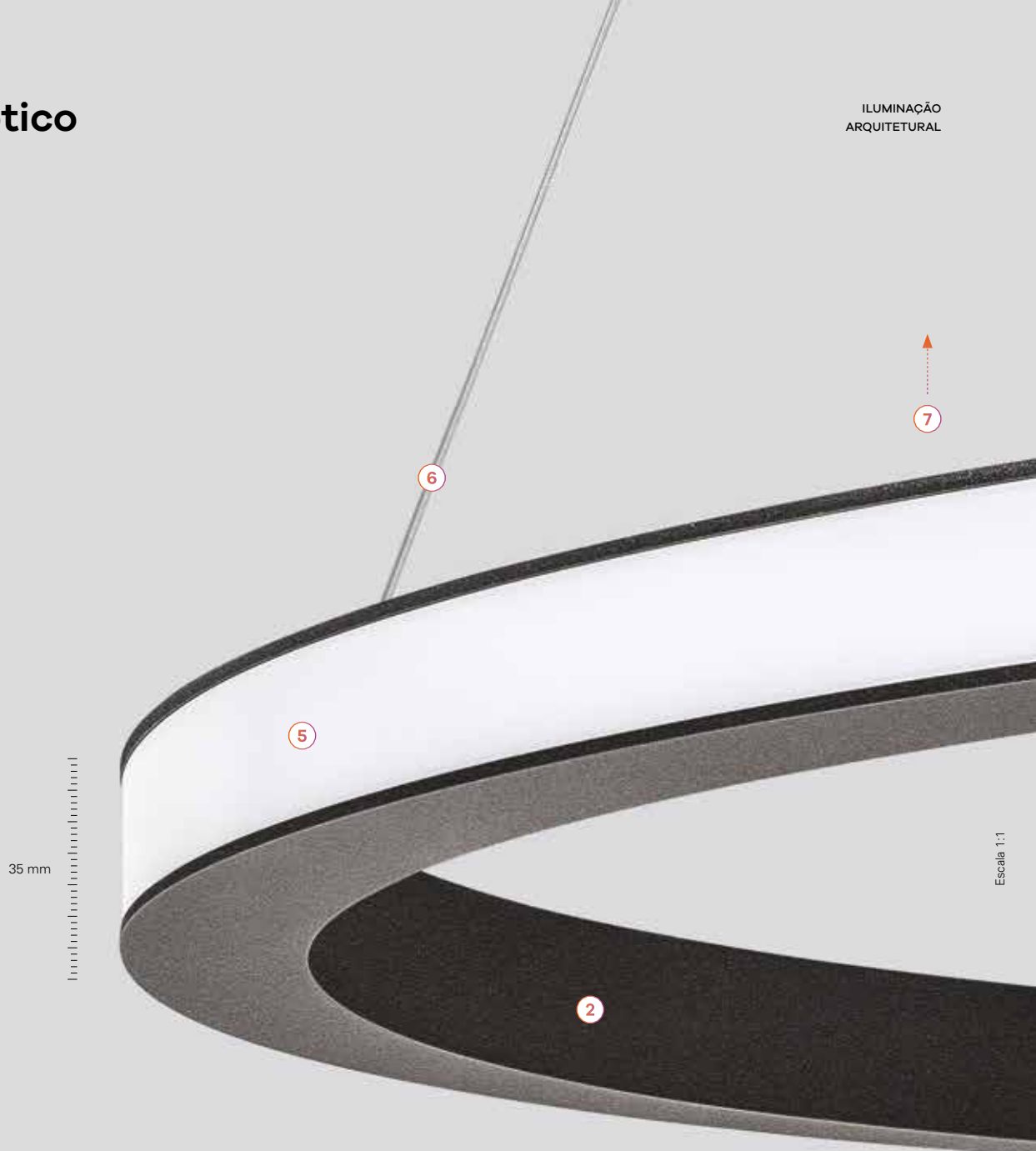

35 mm

Escala 1:1

5. bLINE

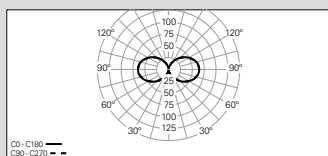

Defina a sua cor

ILUMINAÇÃO
ARQUITETURAL

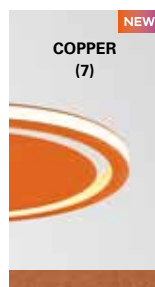
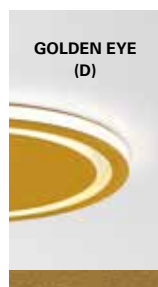
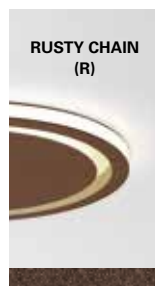
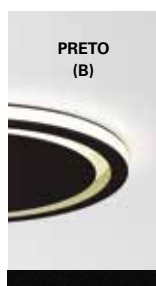

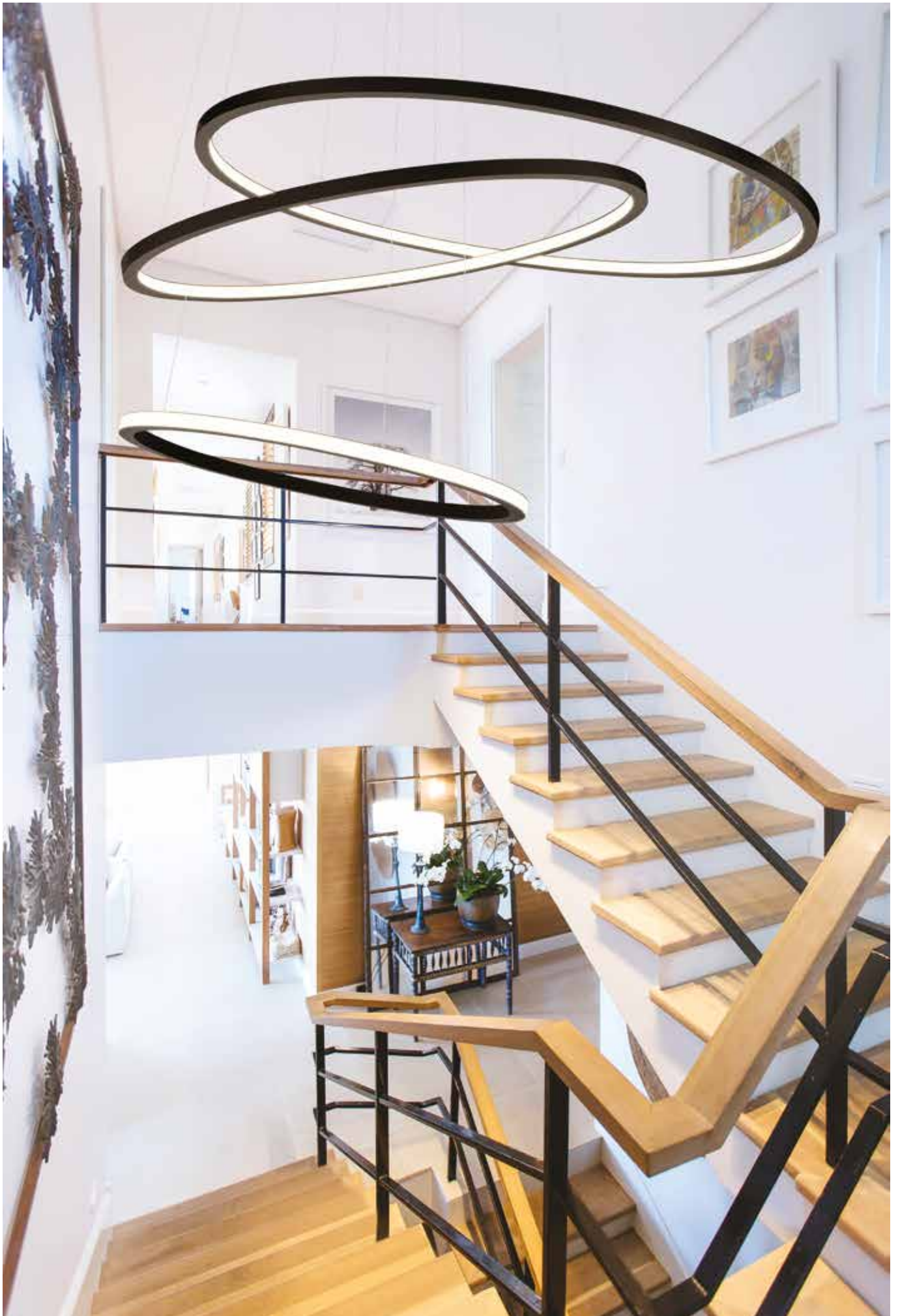

OREO /C



Características do produto

Corpo

Alumínio



Acabamento

Revestido a epóxi-poliéster



Sistema ótico

bLINE - Difusor opalino

Fonte de luz

LED, RG1, CRI>90, MacAdam Step ≤3



Vida útil LED

60.000h @ L80, B10, Ta 25°C

Fonte de alimentação

Driver LED 220-240V-50/60Hz incluído

01. Seleccionar versão



OREO /C



In/Out | bLINE - Difusor opalino

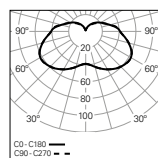

W
51

lm output
1697

lm/W
33

CÓDIGO*
90423L630▼▲●●00

Out | bLINE - Difusor opalino

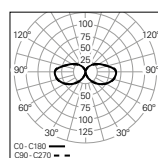

W
31

lm output
1100

lm/W
35

CÓDIGO*
90422L630▼▲●●00

*Substitua os símbolos para completar o código

Fonte de alimentação ▼

HF	E
DALI	H
SwitchDIM ¹	O
OC	T

Cor² ▲

<input type="checkbox"/> Branco	W
<input type="checkbox"/> Cinzento	G
<input type="checkbox"/> Preto	B
<input type="checkbox"/> Sahara	0
<input type="checkbox"/> Mist	1
<input type="checkbox"/> Carbon	I
<input type="checkbox"/> Autumn	L
<input type="checkbox"/> Rusty chain	R
<input type="checkbox"/> Jungle	N
<input type="checkbox"/> Golden eye	D
<input type="checkbox"/> Old rose	5
<input type="checkbox"/> Copper	7

Temp. de Cor ●

2700K	2
3000K	3
4000K	0
Tunable White ³	T
RGB White ⁴	R



Detalhes do produto



Difusor bLINE



Difusor clip-in

¹ Apenas disponível para versões In/Out de 2700K, 3000K ou 4000K.

² Ver página 212.

³ Tunable White (3000K - 5700K). Apenas disponível com fonte de alimentação OC OmniaControl.

⁴ RGB White (2700K). Apenas disponível com fonte de alimentação OC OmniaControl.

OREO In



Características do produto

Corpo

Alumínio

Acabamento

Revestido a epóxi-poliéster

Sistema ótico

bLINE - Difusor opalino

Fonte de luz

LED, RG1, CRI>90, MacAdam Step ≤3

Vida útil LED

60.000h @ L80, B10, Ta 25°C

Fonte de alimentação

Não incluída



01. Selecionar versão



OREO In

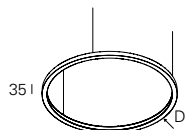

bLINE - Difusor opalino

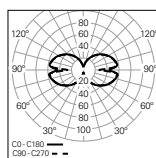

W	lm output	lm/W	Dmm	CÓDIGO*
26	1378	53	Ø650	90400L6500▲0◆00
38	2067	54	Ø970	90400L9700▲0◆00
50	2687	54	Ø1255	90400L1250▲0◆00
61	3307	54	Ø1540	90400L1540▲0◆00
78	4203	54	Ø1955	90400L1950▲0◆00

*Substitua os símbolos para completar o código

Cor ¹	◆
□ Branco	W
■ Cinzento	G
■ Preto	B
■ Sahara	0
■ Mist	1
■ Carbon	I
■ Autumn	L
■ Rusty chain	R
■ Jungle	N
■ Golden eye	D
■ Old rose	5
■ Copper	7

OREO In

- Cabo de alimentação/suspensão com 1500 mm incluído.
- Para completar o produto é necessário encomendar caixa de alimentação em separado.
- Para versões RGB White o produto inclui obrigatoriamente cabo de alimentação transparente.

Temp. de Cor	◆
2700K	2
3000K	3
4000K	0
Tunable White ²	T
RGB White ³	R

¹ Ver página 212.

² Tunable White (3000K - 5700K). Apenas disponível com caixa de alimentação Tunable White + OmniaControl.

³ RGB White (2700K). Apenas disponível com caixa de alimentação RGB White + OmniaControl.

02. Seleccionar caixa de alimentação





Trimless



50 l  Ø120

 Ø128



HF

	CÓDIGO*
Ø650	975800 
Ø970, Ø1255	975801 
Ø1540, Ø1955	975803 





DALI

	CÓDIGO*
Ø650	975900 
Ø970, Ø1255	975901 
Ø1540, Ø1955	975903 





OmniaControl

	CÓDIGO*
Ø650	976000 
Ø970, Ø1255	976001 
Ø1540, Ø1955	976003 

RGB White + OmniaControl

	CÓDIGO*
Ø650, Ø970	976005 
Ø1255	976007 
Ø1540	976008 
Ø1955	976009 

Tunable White + OmniaControl



	CÓDIGO*
Ø650, Ø970	976010 
Ø1255	976012 
Ø1540	976013 
Ø1955	976014 

Encastrar



82 l  Ø150

 Ø128



HF

	CÓDIGO*
Ø650	975500 
Ø970, Ø1255	975501 
Ø1540, Ø1955	975503 





DALI

	CÓDIGO*
Ø650	975600 
Ø970, Ø1255	975601 
Ø1540, Ø1955	975603 





OmniaControl

	CÓDIGO*
Ø650	975700 
Ø970, Ø1255	975701 
Ø1540, Ø1955	975703 

RGB White + OmniaControl

	CÓDIGO*
Ø650, Ø970	975705 
Ø1255	975707 
Ø1540	975708 
Ø1955	975709 



Tunable White + OmniaControl

	CÓDIGO*
Ø650, Ø970	975710 
Ø1255	975712 
Ø1540	975713 
Ø1955	975714 



Saliente

41,5 l  Ø400



HF

	CÓDIGO*
Ø650	975200 
Ø970, Ø1255	975201 
Ø1540, Ø1955	975203 





DALI

	CÓDIGO*
Ø650	975300 
Ø970, Ø1255	975301 
Ø1540, Ø1955	975303 





OmniaControl

	CÓDIGO*
Ø650	975400 
Ø970, Ø1255	975401 
Ø1540, Ø1955	975403 

RGB White + OmniaControl

	CÓDIGO*
Ø650, Ø970	975405 
Ø1255	975407 
Ø1540	975408 
Ø1955	975409 

Tunable White + OmniaControl

	CÓDIGO*
Ø650, Ø970	975410 
Ø1255	975412 
Ø1540	975413 
Ø1955	975414 

*Substitua os símbolos para completar o código

Cor 
 Branco W
 Preto B

CAIXA DE ALIMENTAÇÃO

- Fonte de alimentação incluída na caixa de alimentação.
- A caixa de alimentação trimless e de encastrar é classe III.
- A caixa de alimentação saliente é classe I.



Detalhes do produto



Difusor bLINE



Difusor clip-in



Caixa de alimentação trimless



Caixa de alimentação de encastrar



Caixa de alimentação saliente



Photo: Pedro Sampayo Ribeiro

OREO Out



Características do produto

Corpo

Alumínio

Acabamento

Revestido a epóxi-poliéster

Sistema ótico

bLINE - Difusor opalino

Fonte de luz

LED, RG1, CRI>90, MacAdam Step ≤3

Vida útil LED

60.000h @ L80, B10, Ta 25°C

Fonte de alimentação

Não incluída



01. Selecionar versão



OREO Out

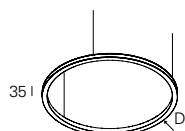

bLINE - Difusor opalino

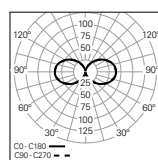

W	lm output	lm/W	Dmm	CÓDIGO*
23	1310	57	Ø630	90401L6300▲0◆00
36	2038	57	Ø950	90401L9500▲0◆00
49	2766	56	Ø1270	90401L1270▲0◆00
60	3422	57	Ø1555	90401L1550▲0◆00
77	4368	57	Ø1970	90401L1970▲0◆00

OREO Out

- Cabo de alimentação/suspensão com 1500 mm incluído.
- Para completar o produto é necessário encomendar caixa de alimentação em separado.
- Para versões RGB White o produto inclui obrigatoriamente cabo de alimentação transparente.

*Substitua os símbolos para completar o código

Cor ¹	◆
□ Branco	W
■ Cinzento	G
■ Preto	B
■ Sahara	0
■ Mist	1
■ Carbon	I
■ Autumn	L
■ Rusty chain	R
■ Jungle	N
■ Golden eye	D
■ Old rose	5
■ Copper	7

Temp. de Cor	◆
2700K	2
3000K	3
4000K	0
Tunable White ²	T
RGB White ³	R

¹ Ver página 212.

² Tunable White (3000K - 5700K). Apenas disponível com caixa de alimentação Tunable White + OmniaControl.

³ RGB White (2700K). Apenas disponível com caixa de alimentação RGB White + OmniaControl.

02. Seleccionar caixa de alimentação





Trimless



50 l  Ø120

 Ø128



HF

	CÓDIGO*
Ø630	975800 
Ø950, Ø1270	975801 
Ø1555, Ø1970	975803 





DALI

	CÓDIGO*
Ø630	975900 
Ø950, Ø1270	975901 
Ø1555, Ø1970	975903 





OmniaControl

	CÓDIGO*
Ø630	976000 
Ø950, Ø1270	976001 
Ø1555, Ø1970	976003 

RGB White + OmniaControl

	CÓDIGO*
Ø630, Ø950	976005 
Ø1270	976007 
Ø1555	976008 
Ø1970	976009 

Tunable White + OmniaControl



	CÓDIGO*
Ø630, Ø950	976010 
Ø1270	976012 
Ø1555	976013 
Ø1970	976014 

Encastrar



82 l  Ø150

 Ø128



HF

	CÓDIGO*
Ø630	975500 
Ø950, Ø1270	975501 
Ø1555, Ø1970	975503 





DALI

	CÓDIGO*
Ø630	975600 
Ø950, Ø1270	975601 
Ø1555, Ø1970	975603 





OmniaControl

	CÓDIGO*
Ø630	975700 
Ø950, Ø1270	975701 
Ø1555, Ø1970	975703 

RGB White + OmniaControl

	CÓDIGO*
Ø630, Ø950	975705 
Ø1270	975707 
Ø1555	975708 
Ø1970	975709 



Tunable White + OmniaControl

	CÓDIGO*
Ø630, Ø950	975710 
Ø1270	975712 
Ø1555	975713 
Ø1970	975714 



Saliente

41,5 l  Ø400



HF

	CÓDIGO*
Ø630	975200 
Ø950, Ø1270	975201 
Ø1555, Ø1970	975203 





DALI

	CÓDIGO*
Ø630	975300 
Ø950, Ø1270	975301 
Ø1555, Ø1970	975303 





OmniaControl

	CÓDIGO*
Ø630	975400 
Ø950, Ø1270	975401 
Ø1555, Ø1970	975403 

RGB White + OmniaControl

	CÓDIGO*
Ø630, Ø950	975405 
Ø1270	975407 
Ø1555	975408 
Ø1970	975409 

Tunable White + OmniaControl

	CÓDIGO*
Ø630, Ø950	975410 
Ø1270	975412 
Ø1555	975413 
Ø1970	975414 

*Substitua os símbolos para completar o código

Cor 
 Branco W
 Preto B

CAIXA DE ALIMENTAÇÃO

- Fonte de alimentação incluída na caixa de alimentação.
- A caixa de alimentação trimless e de encastrar é classe III.
- A caixa de alimentação saliente é classe I.



Detalhes do produto



Difusor bLINE



Difusor clip-in



Caixa de alimentação trimless



Caixa de alimentação de encastrar



Caixa de alimentação saliente

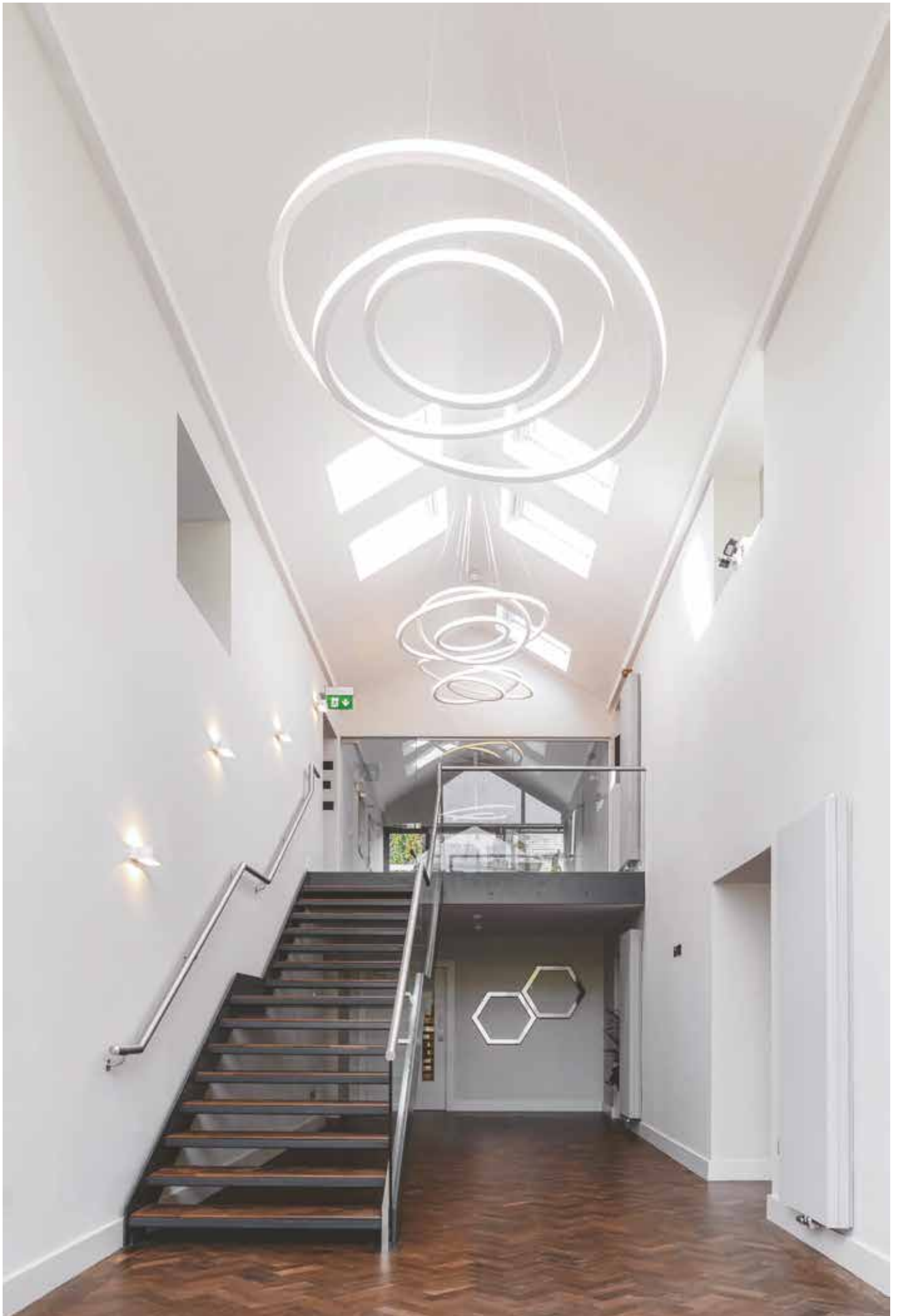

OREO V In



Características do produto

Corpo

Alumínio

Acabamento

Revestido a epóxi-poliéster

Sistema ótico

bLINE - Difusor opalino

Fonte de luz

LED, RG1, CRI>90, MacAdam Step ≤3

Vida útil LED

60.000h @ L80, B10, Ta 25°C

Fonte de alimentação

Não incluída



01. Selecionar versão

OREOV In

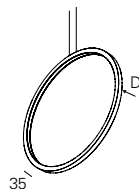

bLINE - Difusor opalino

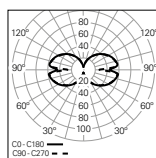

W	lm output	lm/W	Dmm	CÓDIGO*
26	1378	53	Ø650	90425L6500▲0◆00
38	2067	54	Ø970	90425L9700▲0◆00
50	2687	54	Ø1255	90425L1250▲0◆00
61	3307	54	Ø1540	90425L1540▲0◆00
78	4203	54	Ø1955	90425L1950▲0◆00

OREOV In

- Cabo de alimentação/suspensão com 1500 mm incluído.
- Para completar o produto é necessário encomendar caixa de alimentação em separado.
- Para versões Ø1540 e Ø1955 mm o produto inclui obrigatoriamente cabo de alimentação transparente.
- Para versões Tunable White e RGB White o produto inclui obrigatoriamente cabo de alimentação transparente.



*Substitua os símbolos para completar o código

Cor ¹

□ Branco	W
■ Cinzento	G
■ Preto	B
■ Sahara	0
■ Mist	1
■ Carbon	I
■ Autumn	L
■ Rusty chain	R
■ Jungle	N
■ Golden eye	D
■ Old rose	5
■ Copper	7

Temp. de Cor [◆]

2700K	2
3000K	3
4000K	0
Tunable White ²	T
RGB White ³	R

¹ Ver página 212.

² Tunable White (3000K - 5700K). Apenas disponível com caixa de alimentação Tunable White + OmniaControl.

³ RGB White (2700K). Apenas disponível com caixa de alimentação RGB White + OmniaControl.



02. Selecionar caixa de alimentação

Trimless



50 l  Ø120

 Ø128



HF

	CÓDIGO*
Ø650	976700 
Ø970, Ø1255	976701 
Ø1540, Ø1955	976703 



DALI

	CÓDIGO*
Ø650	976800 
Ø970, Ø1255	976801 
Ø1540, Ø1955	976803 



OmniaControl

	CÓDIGO*
Ø650	976900 
Ø970, Ø1255	976901 
Ø1540, Ø1955	976903 

RGB White + OmniaControl

	CÓDIGO*
Ø650, Ø970	976905 
Ø1255, Ø1540	976907 
Ø1955	976909 

Tunable White + OmniaControl



	CÓDIGO*
Ø650, Ø970	976910 
Ø1255, Ø1540	976912 
Ø1955	976914 

Encastrar



82 l  Ø150

 Ø128



HF

	CÓDIGO*
Ø650	976400 
Ø970, Ø1255	976401 
Ø1540, Ø1955	976403 



DALI

	CÓDIGO*
Ø650	976500 
Ø970, Ø1255	976501 
Ø1540, Ø1955	976503 



OmniaControl

	CÓDIGO*
Ø650	976600 
Ø970, Ø1255	976601 
Ø1540, Ø1955	976603 

RGB White + OmniaControl

	CÓDIGO*
Ø650, Ø970	976605 
Ø1255, Ø1540	976607 
Ø1955	976609 

Tunable White + OmniaControl

	CÓDIGO*
Ø650, Ø970	976610 
Ø1255, Ø1540	976612 
Ø1955	976614 

Saliente



a) 270
135  44

b) 320
145  44



HF

	CÓDIGO*
Ø650 ^{a)}	976100 
Ø970, Ø1255 ^{a)}	976101 
Ø1540, Ø1955 ^{b)}	976103 





DALI

	CÓDIGO*
Ø650 ^{a)}	976200 
Ø970, Ø1255 ^{a)}	976201 
Ø1540, Ø1955 ^{b)}	976203 



OmniaControl

	CÓDIGO*
Ø650 ^{a)}	976300 
Ø970, Ø1255 ^{a)}	976301 
Ø1540, Ø1955 ^{b)}	976303 

RGB White + OmniaControl

	CÓDIGO*
Ø650, Ø970 ^{a)}	976305 
Ø1255 ^{a)}	976307 
Ø1540 ^{b)}	976308 
Ø1955 ^{b)}	976309 

Tunable White + OmniaControl

	CÓDIGO*
Ø650, Ø970 ^{a)}	976310 
Ø1255 ^{a)}	976312 
Ø1540 ^{b)}	976313 
Ø1955 ^{b)}	976314 



*Substitua os símbolos para completar o código

Cor 
 Branco **W**
 Preto **B**

CAIXA DE ALIMENTAÇÃO

- Fonte de alimentação incluída na caixa de alimentação.
- A caixa de alimentação trimless e de encastrar é classe III.
- A caixa de alimentação saliente é classe I.



Detalhes do produto



Difusor bLINE



Difusor clip-in

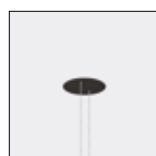

Caixa de alimentação trimless

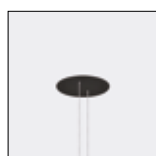

Caixa de alimentação de encastrar



Caixa de alimentação saliente

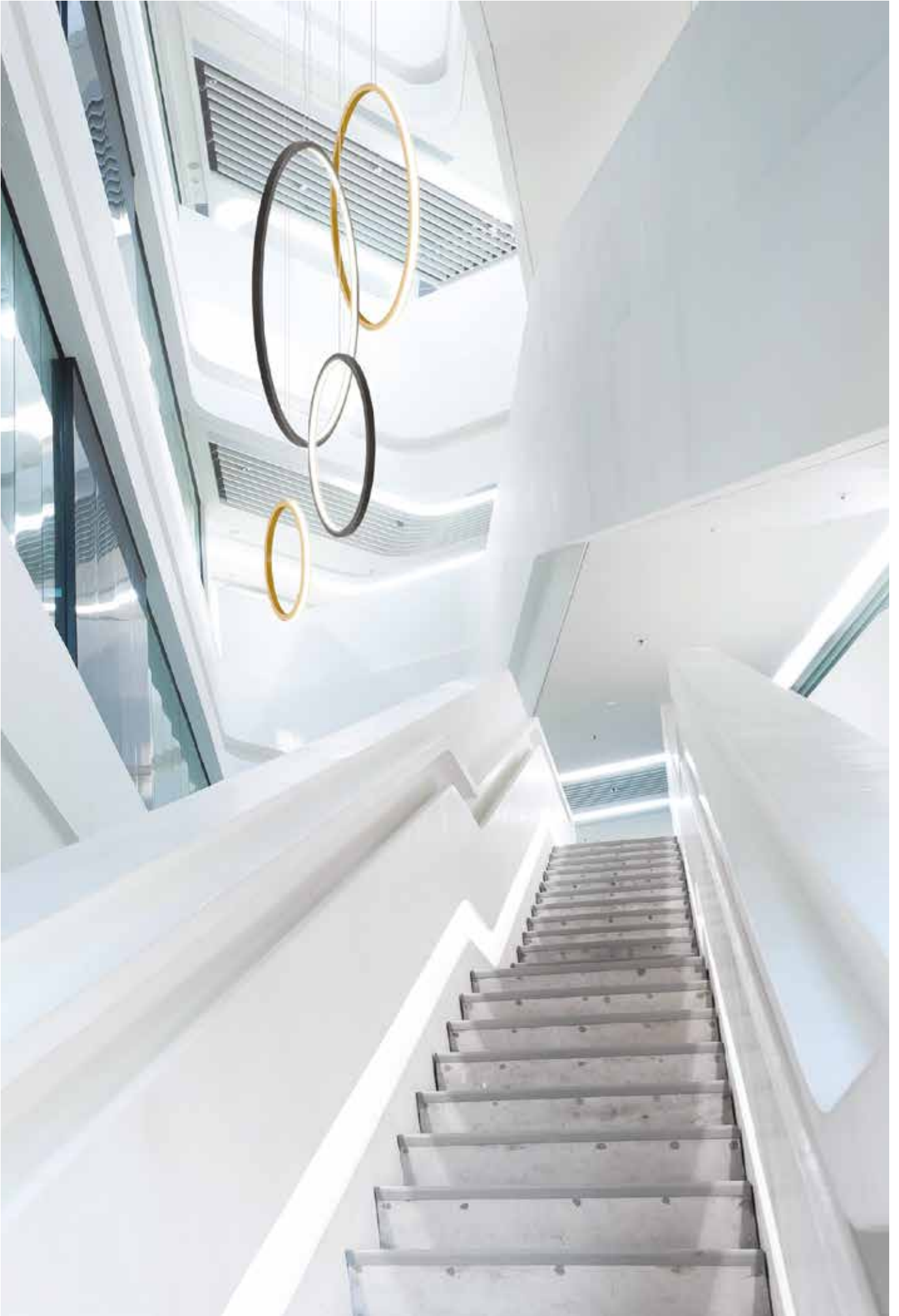

OREO V Out



Características do produto

Corpo

Alumínio

Acabamento

Revestido a epóxi-poliéster

Sistema ótico

bLINE - Difusor opalino

Fonte de luz

LED, RG1, CRI>90, MacAdam Step ≤3

Vida útil LED

60.000h @ L80, B10, Ta 25°C

Fonte de alimentação

Não incluída



01. Selecionar versão

OREOV Out

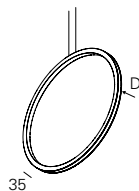

bLINE - Difusor opalino

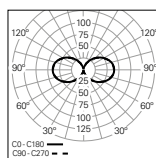

W	lm output	lm/W	Dmm	CÓDIGO*
22	1238	56	Ø630	90419L6300▲0♦00
35	1966	56	Ø950	90419L9500▲0♦00
47	2694	57	Ø1270	90419L1270▲0♦00
59	3349	57	Ø1555	90419L1550▲0♦00
76	4295	57	Ø1970	90419L1970▲0♦00

OREOV Out

- Cabo de alimentação/suspensão com 1500 mm incluído.
- Para completar o produto é necessário encomendar caixa de alimentação em separado.
- Para versões Ø1555 e Ø1970 mm o produto inclui obrigatoriamente cabo de alimentação transparente.
- Para versões Tunable White e RGB White o produto inclui obrigatoriamente cabo de alimentação transparente.



*Substitua os símbolos para completar o código

Cor ¹	◆
□ Branco	W
■ Cinzento	G
■ Preto	B
■ Sahara	0
■ Mist	1
■ Carbon	I
■ Autumn	L
■ Rusty chain	R
■ Jungle	N
■ Golden eye	D
■ Old rose	5
■ Copper	7

Temp. de Cor	◆
2700K	2
3000K	3
4000K	0
Tunable White ²	T
RGB White ³	R

¹ Ver página 212.

² Tunable White (3000K - 5700K). Apenas disponível com caixa de alimentação Tunable White + OmniaControl.

³ RGB White (2700K). Apenas disponível com caixa de alimentação RGB White + OmniaControl.

02. Selecionar caixa de alimentação

Trimless

50 |  Ø120

 Ø128

HF

	CÓDIGO*
Ø630	976700
Ø950, Ø1270	976701
Ø1555, Ø1970	976703

DALI

	CÓDIGO*
Ø630	976800
Ø950, Ø1270	976801
Ø1555, Ø1970	976803

OmniaControl

	CÓDIGO*
Ø630	976900
Ø950, Ø1270	976901
Ø1555, Ø1970	976903

RGB White + OmniaControl

	CÓDIGO*
Ø630, Ø950	976905
Ø1270, Ø1555	976907
Ø1970	976909

Tunable White + OmniaControl

	CÓDIGO*
Ø630, Ø950	976910
Ø1270, Ø1555	976912
Ø1970	976914

Encastrar

82 |  Ø150

 Ø128

HF

	CÓDIGO*
Ø630	976400
Ø950, Ø1270	976401
Ø1555, Ø1970	976403

DALI

	CÓDIGO*
Ø630	976500
Ø950, Ø1270	976501
Ø1555, Ø1970	976503

OmniaControl

	CÓDIGO*
Ø630	976600
Ø950, Ø1270	976601
Ø1555, Ø1970	976603

RGB White + OmniaControl

	CÓDIGO*
Ø630, Ø950	976605
Ø1270, Ø1555	976607
Ø1970	976609

Tunable White + OmniaControl

	CÓDIGO*
Ø630, Ø950	976610
Ø1270, Ø1555	976612
Ø1970	976614

Saliente

a) 270
135 |  44

b) 320
145 |  44

HF

	CÓDIGO*
Ø630 ^{a)}	976100
Ø950, Ø1270 ^{a)}	976101
Ø1555, Ø1970 ^{b)}	976103

DALI

	CÓDIGO*
Ø630 ^{a)}	976200
Ø950, Ø1270 ^{a)}	976201
Ø1555, Ø1970 ^{b)}	976203

OmniaControl

	CÓDIGO*
Ø630 ^{a)}	976300
Ø950, Ø1270 ^{a)}	976301
Ø1555, Ø1970 ^{b)}	976303

RGB White + OmniaControl

	CÓDIGO*
Ø630, Ø950 ^{a)}	976305
Ø1270 ^{a)}	976307
Ø1555 ^{b)}	976308
Ø1970 ^{b)}	976309

Tunable White + OmniaControl

	CÓDIGO*
Ø630, Ø950 ^{a)}	976310
Ø1270 ^{a)}	976312
Ø1555 ^{b)}	976313
Ø1970 ^{b)}	976314



*Substitua os símbolos para completar o código

Cor  Branco **W**
 Preto **B**

CAIXA DE ALIMENTAÇÃO

- Fonte de alimentação incluída na caixa de alimentação.
- A caixa de alimentação trimless e de encastrar é classe III.
- A caixa de alimentação saliente é classe I.



Detalhes do produto



Difusor bLINE



Difusor clip-in

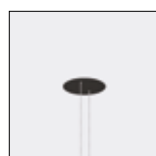

Caixa de alimentação trimless

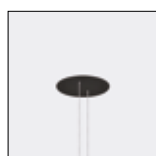

Caixa de alimentação de encastrar



Caixa de alimentação saliente



OREO Linea Down



Características do produto

Corpo

Alumínio

Acabamento

Revestido a epóxi-poliéster

Sistema ótico

bLINE - Difusor opalino

Fonte de luz

LED, RG1, CRI>90, MacAdam Step ≤3

Vida útil LED

60.000h @ L80, B10, Ta 25°C

Fonte de alimentação

Não incluída



01. Seleccionar versão

OREO Linea Down

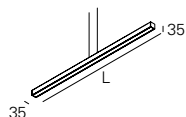

bLINE - Difusor opalino

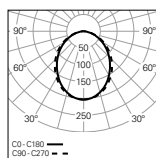

W	lm output	lm/W	Lmm	CÓDIGO*
13	637	49	1014	90420L1010▲0◆00
19	956	50	1514	90420L1510▲0◆00
26	1274	49	2014	90420L2010▲0◆00

OREO Linea Down

- Cabo de alimentação/suspensão com 1500 mm incluído.
- Para completar o produto é necessário encomendar caixa de alimentação em separado.
- Para versões Tunable White e RGB White o produto inclui obrigatoriamente cabo de alimentação transparente.



*Substitua os símbolos para completar o código

Cor ¹	◆
□ Branco	W
■ Cinzento	G
■ Preto	B
■ Sahara	0
■ Mist	1
■ Carbon	I
■ Autumn	L
■ Rusty chain	R
■ Jungle	N
■ Golden eye	D
■ Old rose	5
■ Copper	7

Temp. de Cor	◆
2700K	2
3000K	3
4000K	0
Tunable White ²	T
RGB White ³	R

¹ Ver página 212.

² Tunable White (3000K - 5700K). Apenas disponível com caixa de alimentação Tunable White + OmniaControl.

³ RGB White (2700K). Apenas disponível com caixa de alimentação RGB White + OmniaControl.

02. Seleccionar caixa de alimentação

Trimless



122x62

HF

L1014, L1514, L2014
CÓDIGO* 977600♣

Encastrar



154x68

HF

L1014, L1514, L2014
CÓDIGO* 977300♣

Saliente



HF

L1014, L1514, L2014
CÓDIGO* 977900♣



*Substitua os símbolos para completar o código

Cor
 Branco W
 Preto B

DALI

L1014, L1514, L2014
CÓDIGO* 977700♣

DALI

L1014, L1514, L2014
CÓDIGO* 977400♣

DALI

L1014, L1514, L2014
CÓDIGO* 978000♣

OmniaControl

L1014, L1514, L2014
CÓDIGO* 977800♣

OmniaControl

L1014, L1514, L2014
CÓDIGO* 977500♣

OmniaControl

L1014, L1514, L2014
CÓDIGO* 978100♣

RGB White + OmniaControl

L1014, L1514
L2014
CÓDIGO* 977805♣
977806♣

RGB White + OmniaControl

L1014, L1514
L2014
CÓDIGO* 977505♣
977506♣

RGB White + OmniaControl

L1014, L1514
L2014
CÓDIGO* 978105♣
978106♣

Tunable White + OmniaControl

L1014, L1514
L2014
CÓDIGO* 977810♣
977811♣

Tunable White + OmniaControl

L1014, L1514
L2014
CÓDIGO* 977510♣
977511♣

Tunable White + OmniaControl

L1014, L1514
L2014
CÓDIGO* 978110♣
978111♣

CAIXA DE ALIMENTAÇÃO

- Fonte de alimentação incluída na caixa de alimentação.
- A caixa de alimentação trimless e de encastrar é classe III.
- A caixa de alimentação saliente é classe I.



Detalhes do produto



Difusor bLINE

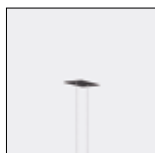

Caixa de alimentação trimless



Caixa de alimentação de encastrar



Caixa de alimentação saliente



OREO Linea Up



Características do produto

Corpo

Alumínio

Acabamento

Revestido a epóxi-poliéster

Sistema ótico

bLINE - Difusor opalino

Fonte de luz

LED, RG1, CRI>90, MacAdam Step ≤ 3

Vida útil LED

60.000h @ L80, B10, Ta 25°C

Fonte de alimentação

Não incluída



01. Seleccionar versão

OREO Linea Up

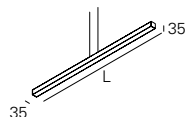

bLINE - Difusor opalino

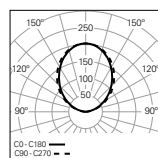

W	lm output	lm/W	Lmm	CÓDIGO*
12	573	48	1014	90399L1010♣0♦00
18	892	50	1514	90399L1510♣0♦00
24	1210	50	2014	90399L2010♣0♦00

OREO Linea Up

- Cabo de alimentação/suspensão com 1500 mm incluída.
- Para completar o produto é necessário encomendar caixa de alimentação em separado.
- Para versões Tunable White e RGB White o produto inclui obrigatoriamente cabo de alimentação transparente.



*Substitua os símbolos para completar o código

Cor ¹

□ Branco	W
■ Cinzento	G
■ Preto	B
■ Sahara	0
■ Mist	1
■ Carbon	I
■ Autumn	L
■ Rusty chain	R
■ Jungle	N
■ Golden eye	D
■ Old rose	5
■ Copper	7

Temp. de Cor

2700K	2
3000K	3
4000K	0
Tunable White ²	T
RGB White ³	R

¹ Ver página 212.

² Tunable White (3000K - 5700K). Apenas disponível com caixa de alimentação Tunable White + OmniaControl.

³ RGB White (2700K). Apenas disponível com caixa de alimentação RGB White + OmniaControl.

02. Selecionar caixa de alimentação

Trimless



122x62

HF

L1014, L1514, L2014
CÓDIGO* 977600♣

DALI

L1014, L1514, L2014
CÓDIGO* 977700♣

OmniaControl

L1014, L1514, L2014
CÓDIGO* 977800♣

RGB White + OmniaControl

L1014, L1514
L2014
CÓDIGO* 977805♣
977806♣

Tunable White + OmniaControl

L1014, L1514
L2014
CÓDIGO* 977810♣
977811♣

Encastrar



154x68

HF

L1014, L1514, L2014
CÓDIGO* 977300♣

DALI

L1014, L1514, L2014
CÓDIGO* 977400♣

OmniaControl

L1014, L1514, L2014
CÓDIGO* 977500♣

RGB White + OmniaControl

L1014, L1514
L2014
CÓDIGO* 977505♣
977506♣

Tunable White + OmniaControl

L1014, L1514
L2014
CÓDIGO* 977510♣
977511♣

Saliente



HF

L1014, L1514, L2014
CÓDIGO* 977900♣

DALI

L1014, L1514, L2014
CÓDIGO* 978000♣

OmniaControl

L1014, L1514, L2014
CÓDIGO* 978100♣

RGB White + OmniaControl

L1014, L1514
L2014
CÓDIGO* 978105♣
978106♣

Tunable White + OmniaControl

L1014, L1514
L2014
CÓDIGO* 978110♣
978111♣



*Substitua os símbolos para completar o código

Cor
□ Branco W
■ Preto B

CAIXA DE ALIMENTAÇÃO

- Fonte de alimentação incluída na caixa de alimentação.
- A caixa de alimentação trimless e de encastrar é classe III.
- A caixa de alimentação saliente é classe I.



Detalhes do produto



Difusor bLINE

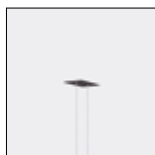

Caixa de alimentação trimless

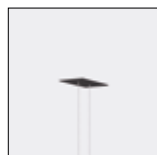

Caixa de alimentação de encastrar



Caixa de alimentação saliente

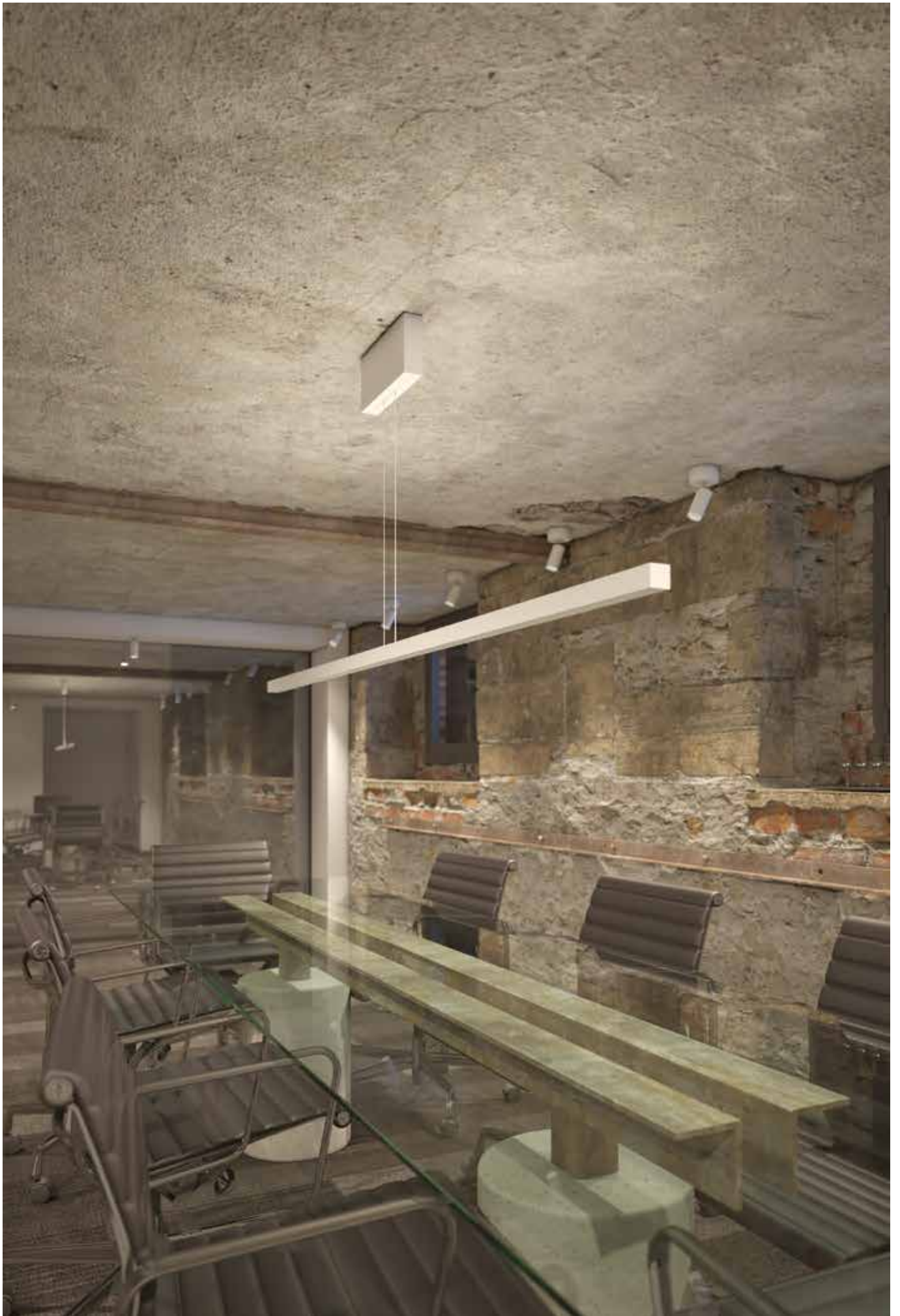



GLAM



GLAM
248



GLAM S4
254



GLAM S8
258



GLAM /W E
264



GLAM /W
268



GLAM 48V
274



Tipos de aplicação



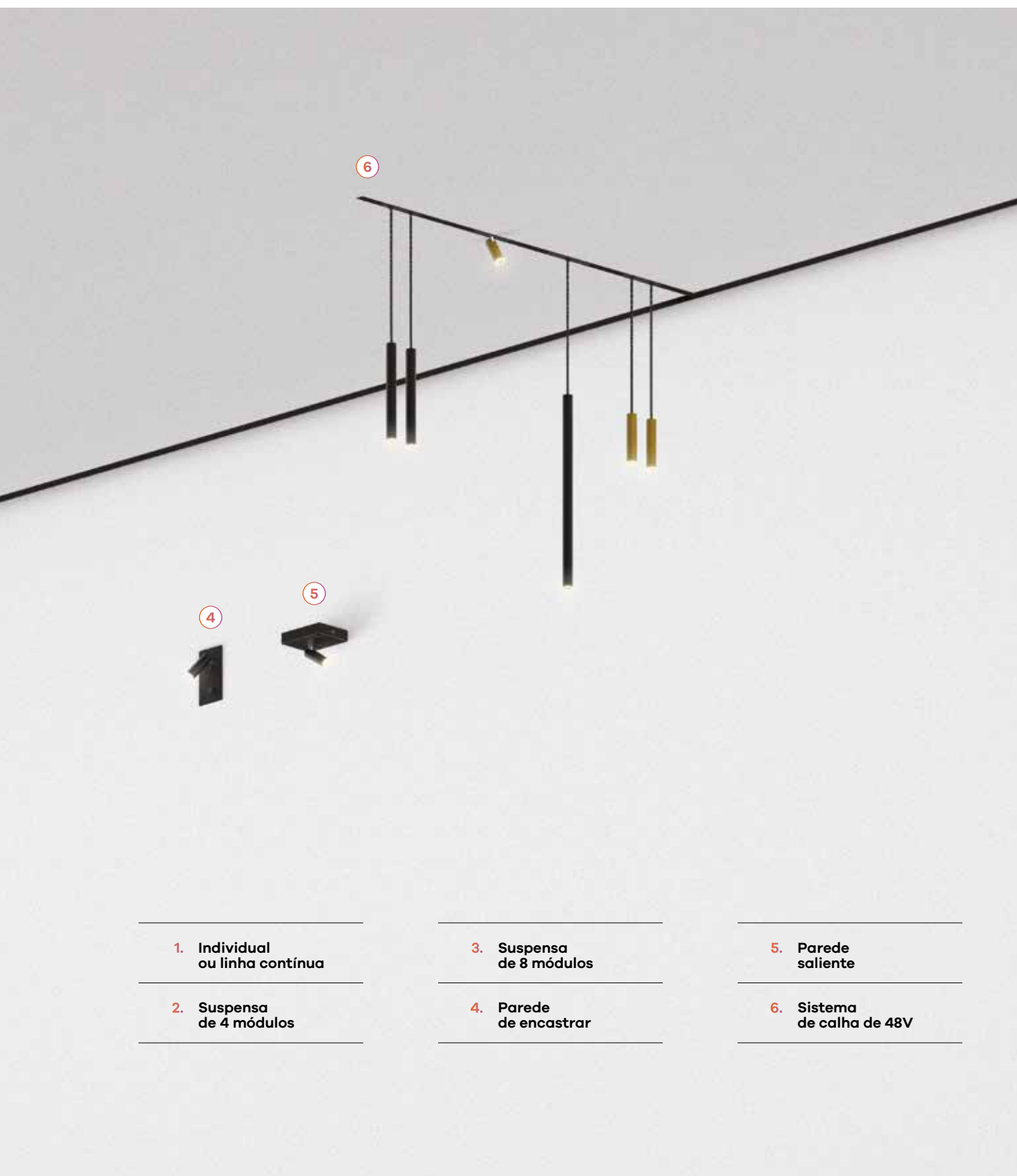

1. Individual
ou linha contínua

2. Suspensa
de 4 módulos

3. Suspensa
de 8 módulos

4. Parede
de encastrar

5. Parede
saliente

6. Sistema
de calha de 48V

Minimalismo e tecnologia



Escala 1:1

1. Corpo

Tubo em alumínio.
Disponível na versão suspensa com dimensões de 150, 300, 450 ou 600 mm, versão de projetor com dimensões de 80, 150 ou 300 mm e versão de encastrar com Ø59 mm.
12 cores disponíveis.



2. LED

SDCM MacAdam ≤ 3 ,
temperatura de cor 2700K / 4000K, CRI > 80 e vida útil de 75.000h L90 B10.

3. Fixação do LED

4. Sistema ótico

- 4.1 Lente de 14°
- 4.2 Lente de 47°
- 4.3 Lente oval

5. Aro decorativo

O aro decorativo com sistema clip-in suporta a lente e proporciona um acabamento minimalista e moderno.

6. Cabo de alimentação e sistema de fixação

Cabo de alimentação em tecido laranja, preto ou castanho disponível com 1500 mm.
Sistema de fixação rápida clip-in.



Sistema ótico

ILUMINAÇÃO
ARQUITETURAL



4.1. Lente de 14°

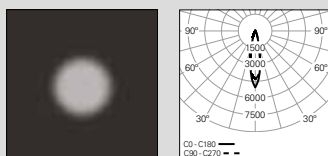
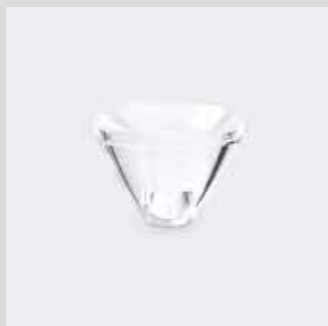

4.2. Lente de 47°

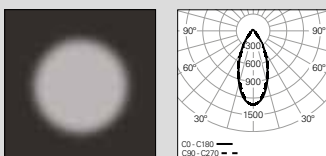
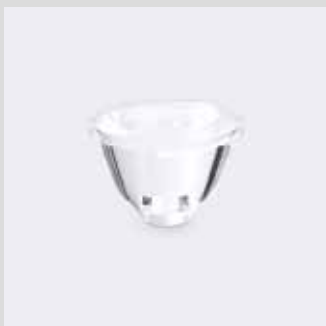

4.3. Lente oval

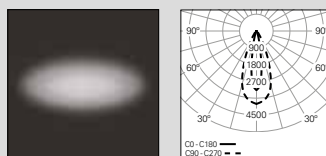
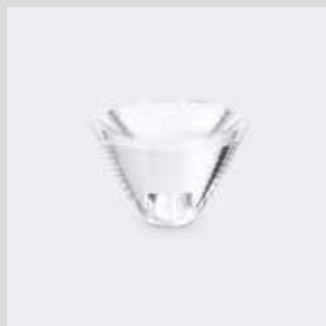

Defina a sua cor

ILUMINAÇÃO
ARQUITETURAL





GLAM

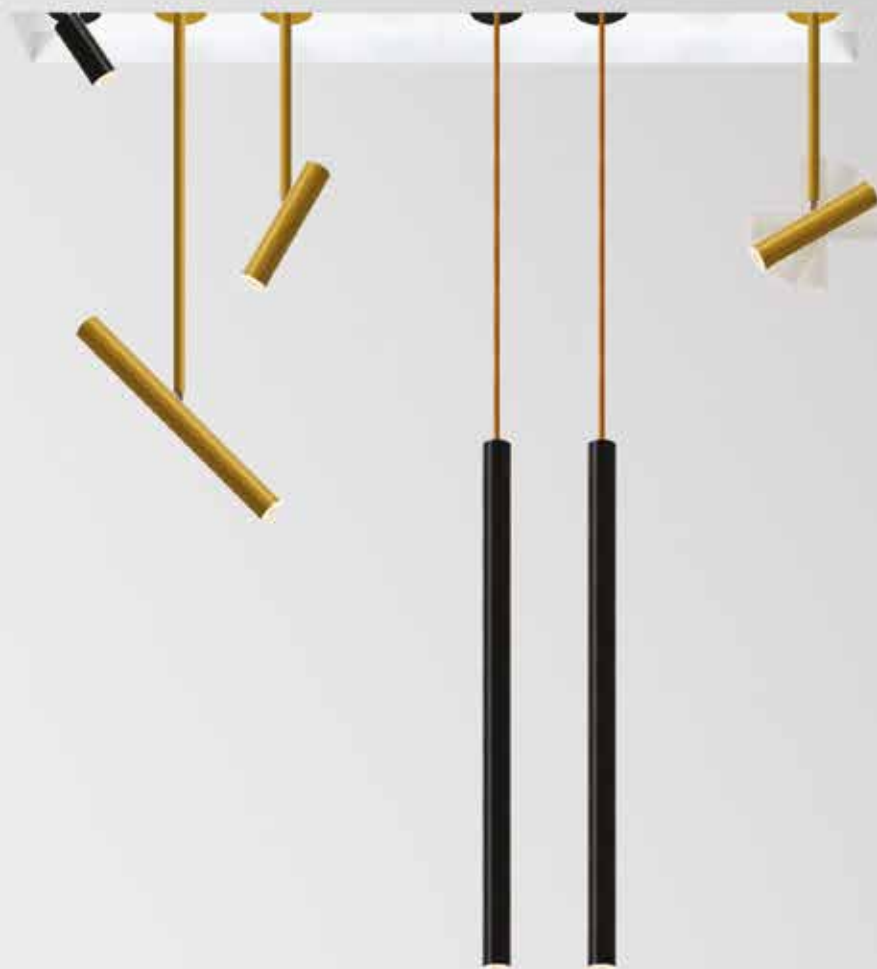

Características do produto

Corpo

Alumínio

Acabamento

Revestido a epóxi-poliéster

Sistema ótico

Lente

Fonte de luz

LED, RG1, CRI>80, MacAdam Step ≤3

Vida útil LED

75.000h @ L90, B10, Ta 25°C

Fonte de alimentação

Não incluída



01. Seleccionar módulo



/S - Suspense

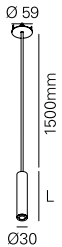

Lente (Não incluída)

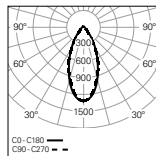

UGR	W	lm output	lm/W	mA	Lmm	CÓDIGO*
≤19	2	228	114	700	150	90063L150E▲0♦00
≤19	2	228	114	700	300	90063L300E▲0♦00
≤19	2	228	114	700	450	90063L450E▲0♦00
≤19	2	228	114	700	600	90063L600E▲0♦00

*Substitua os símbolos para completar o código

Cor ¹	◆
□ Branco	W
■ Cinzento	G
■ Preto	B
■ Sahara	0
■ Mist	1
■ Carbon	I
■ Autumn	L
■ Rusty chain	R
■ Jungle	N
■ Golden eye	D
■ Old rose	5
■ Copper	7

Temp. de Cor	◆
2700K	2
4000K	0

/S - Suspense

- Para completar o produto é necessário encomendar sistema ótico, cabo e caixa de alimentação em separado.
- Os valores indicados são referentes a lentes de 47°.
- O módulo suspense é classe III.

SPOT - Projetor

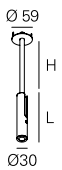

Lente (Não incluída)

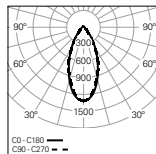

UGR	W	lm output	lm/W	mA	Lmm	Hmm	CÓDIGO*
≤19	2	228	114	700	80	12	90064L080E▲0♦00
≤19	2	228	114	700	150	197	90064L150E▲0♦00
≤19	2	228	114	700	300	371	90064L300E▲0♦00

SPOT - Projetor

- Para completar o produto é necessário encomendar sistema ótico e caixa de alimentação em separado.
- Os valores indicados são referentes a lentes de 47°.
- O módulo SPOT - Projetor é classe III.

/E - Encastrar



Lente (Não incluída)

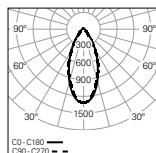

UGR	W	lm output	lm/W	mA	CÓDIGO*
≤19	2	228	114	700	90065L000E▲0♦00

/E - Encastrar

- Para completar o produto é necessário encomendar sistema ótico e caixa de alimentação em separado.
- Os valores indicados são referentes a lentes de 47°.
- O módulo encastrar é classe III.

¹ Ver página 246.

02. Selecionar caixa de alimentação



Trimless

Circular - 1 módulo LED

mA **CÓDIGO***
700 973301▲

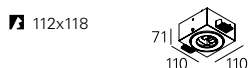

Encastrar

Circular - 1 módulo LED

mA **CÓDIGO***
700 973801▲



Saliente

Circular - 1 módulo LED

mA **CÓDIGO***
700 974301▲



*Substitua os símbolos para completar o código

Cor ▲
□ Branco W
■ Preto B

Quadrada - 1 módulo LED

mA **CÓDIGO***
700 973401▲

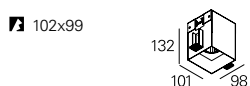

Quadrada - 1 módulo LED

mA **CÓDIGO***
700 973901▲



Quadrada - 1 módulo LED

mA **CÓDIGO***
700 974401▲



Retangular - 2 módulos LED

mA **CÓDIGO***
700 973402▲

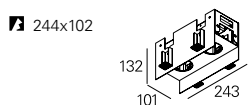

Retangular - 2 módulos LED

mA **CÓDIGO***
700 973902▲

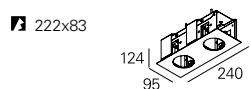

Retangular - 2 módulos LED

mA **CÓDIGO***
700 974402▲

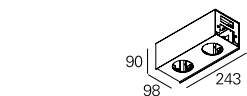

Retangular - 3 módulos LED

mA **CÓDIGO***
700 973403▲

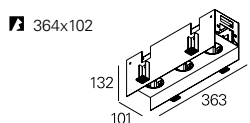

Retangular - 3 módulos LED

mA **CÓDIGO***
700 973903▲

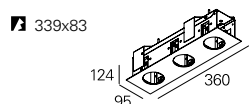

Retangular - 3 módulos LED

mA **CÓDIGO***
700 974403▲

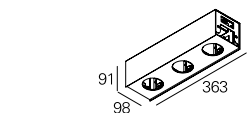

Retangular - 4 módulos LED

mA **CÓDIGO***
700 973404▲

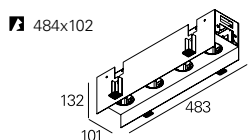

Retangular - 4 módulos LED

mA **CÓDIGO***
700 973904▲

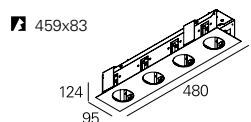

Retangular - 4 módulos LED



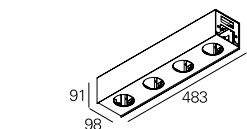

mA **CÓDIGO***
700 974404▲



CAIXA DE ALIMENTAÇÃO

- Fonte de alimentação HF incluída na caixa de alimentação.
- Versões de 1 módulo LED são individuais. Versões de 2, 3 e 4 módulos LED podem ser individuais ou linha contínua.
- Versões de 2, 3 e 4 módulos LED não incluem start kit. Para completar uma linha é necessário encomendar start kit em separado.
- A caixa de alimentação é classe I.

03. Selecionar opções

OPÇÕES		Código*
Sistema ótico		
Lente de 14°		926200
Lente de 47°		926201
Lente oval		926202
Start kit - topo início/fim		
Trimless		922300▲
Encastrar		922400▲
Saliente		922500▲
• Dois topos e parafusos incluídos.		
Cablagem linha contínua		
L240 mm - 3 x 1,5 mm ²		945620
L360 mm - 3 x 1,5 mm ²		945621
L480 mm - 3 x 1,5 mm ²		945622
Kit de união		
Encastrar		931701
• Parafusos incluídos.		
Trimless / Saliente		931700
• Parafusos incluídos.		
Tampa cega		
Branco	 Ø 59	992700
Preto		992702
Cabo de alimentação em tecido		
L1500 mm - Laranja		941700
L1500 mm - Preto		941800
L1500 mm - Castanho		941900



*Substitua os símbolos para completar o código

Cor ▲
 Branco W
 Preto B



Detalhes do produto



Lentes 14°, 47° ou oval



Sistema de fixação da lente



Efeito de luz com lente de 14°



Efeito de luz com lente de 47°



Efeito de luz com lente oval



Fixação e conexão rápida



Rotação de 355° e inclinação de 90°

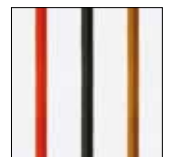

Cabo de alimentação em tecido (3 cores)





GLAM S4



Características do produto

Corpo

Alumínio

Acabamento

Revestido a epóxi-poliéster

Sistema ótico

Lente

Fonte de luz

LED, RG1, CRI>80, MacAdam Step ≤3

Vida útil LED

75.000h @ L90, B10, Ta 25°C

Fonte de alimentação

Driver LED 220-240V-50/60Hz incluído



230V/50Hz



IP 20

650°C



01. Selecionar versão

GLAM S4 /E

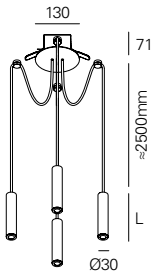

/E - Caixa de alimentação de encastrar | Lente (Não incluída)

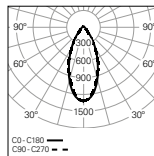

UGR	W	lm output	lm/W	Lmm	Ø	CÓDIGO*
≤19	11	912	83	150	Ø112	90098L150E♣0♦00
≤19	11	912	83	300	Ø112	90098L300E♣0♦00
≤19	11	912	83	450	Ø112	90098L450E♣0♦00
≤19	11	912	83	600	Ø112	90098L600E♣0♦00



*Substitua os símbolos para completar o código

Cor ¹	◆
□ Branco	W
■ Cinzento	G
■ Preto	B
■ Sahara	0
■ Mist	1
■ Carbon	I
■ Autumn	L
■ Rusty chain	R
■ Jungle	N
■ Golden eye	D
■ Old rose	5
■ Copper	7

GLAM S4 /C

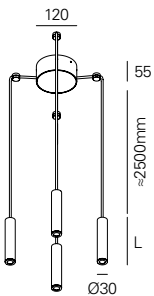

/C - Caixa de alimentação saliente | Lente (Não incluída)

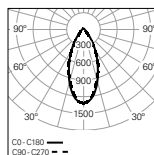

UGR	W	lm output	lm/W	Lmm	CÓDIGO*
≤19	11	912	83	150	90093L150E♣0♦00
≤19	11	912	83	300	90093L300E♣0♦00
≤19	11	912	83	450	90093L450E♣0♦00
≤19	11	912	83	600	90093L600E♣0♦00

Temp. de Cor	◆
2700K	2
4000K	0

GLAM S4 /E | GLAM S4 /C

- 4 cliques transparentes incluídos.
- Para completar o produto é necessário encomendar sistema ótico e cabo de alimentação em separado.
- Os valores indicados são referentes a lentes de 47°.
- Caixa de alimentação na cor do produto. Outras cores sob consulta.

¹ Ver página 246.

02. Selecionar opções

OPÇÕES	Código
Sistema óptico	
Lente de 14°	926200
Lente de 47°	926201
Lente oval	926202
• Para completar o produto é necessário encomendar 4 lentes.	
Sistema de fixação	
Clip transparente	926210
Cabo de alimentação em tecido	
L2500 mm - Laranja	941701
L2500 mm - Preto	941801
L2500 mm - Castanho	941901
• Para completar o produto é necessário encomendar 4 cabos de alimentação.	



Detalhes do produto



Lentes 14°, 47° ou oval



Sistema de fixação da lente



Efeito de luz com lente de 14°



Efeito de luz com lente de 47°

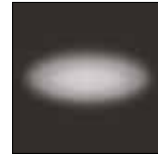

Efeito de luz com lente oval

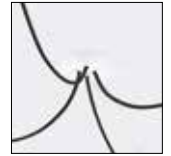

Caixa de alimentação de encastrar

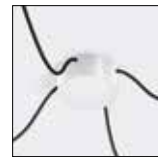

Caixa de alimentação saliente

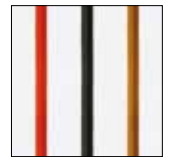

Cabo de alimentação em tecido (3 cores)



Clip transparente



GLAM S8



Características do produto

Corpo

Alumínio

Acabamento

Revestido a epóxi-poliéster

Sistema ótico

Lente

Fonte de luz

LED, RG1, CRI>80, MacAdam Step ≤ 3

Vida útil LED

75.000h @ L90, B10, Ta 25°C

Fonte de alimentação

Driver LED 220-240V-50/60Hz incluído



230V/50Hz



IP 20

650°C

01. Seleccionar versão



GLAM S8 /E

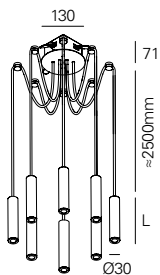

/E - Caixa de alimentação de encastrar | Lente (Não incluída)

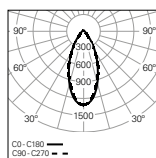

UGR	W	lm output	lm/W	Lmm	Ø	CÓDIGO*
≤19	20	1824	91	150	Ø112	90101L150E♣0♦00
≤19	20	1824	91	300	Ø112	90101L300E♣0♦00
≤19	20	1824	91	450	Ø112	90101L450E♣0♦00
≤19	20	1824	91	600	Ø112	90101L600E♣0♦00

*Substitua os símbolos para completar o código

Cor ¹	Símbolo
Branco	W
Cinzento	G
Preto	B
Sahara	0
Mist	1
Carbon	I
Autumn	L
Rusty chain	R
Jungle	N
Golden eye	D
Old rose	5
Copper	7

GLAM S8 /C

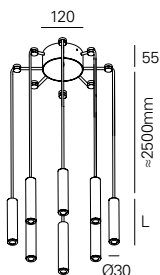

/C - Caixa de alimentação saliente | Lente (Não incluída)

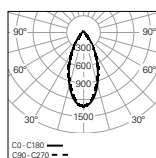

UGR	W	lm output	lm/W	Lmm	CÓDIGO*
≤19	20	1824	91	150	90099L150E♣0♦00
≤19	20	1824	91	300	90099L300E♣0♦00
≤19	20	1824	91	450	90099L450E♣0♦00
≤19	20	1824	91	600	90099L600E♣0♦00

Temp. de Cor	Símbolo
2700K	2
4000K	0

GLAM S8 /E | GLAM S8 /C

- 8 cliques transparentes incluídos.
- Para completar o produto é necessário encomendar sistema ótico e cabo de alimentação em separado.
- Os valores indicados são referentes a lentes de 47°.
- Caixa de alimentação na cor do produto. Outras cores sob consulta.

¹ Ver página 246.

02. Selecionar opções

OPÇÕES	Código
Sistema ótico	
Lente de 14°	926200
Lente de 47°	926201
Lente oval	926202
• Para completar o produto é necessário encomendar 8 lentes.	
Sistema de fixação	
Clip transparente	926210
Cabo de alimentação em tecido	
L2500 mm - Laranja	941701
L2500 mm - Preto	941801
L2500 mm - Castanho	941901
• Para completar o produto é necessário encomendar 8 cabos de alimentação.	



Detalhes do produto



Lentes 14°, 47° ou oval



Sistema de fixação da lente



Efeito de luz com lente de 14°



Efeito de luz com lente de 47°



Efeito de luz com lente oval

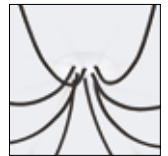

Caixa de alimentação de encastrar



Caixa de alimentação saliente

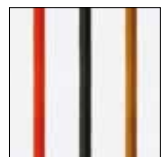

Cabo de alimentação em tecido (3 cores)



Clip transparente



Versões de parede



1. Rotação a 355° e inclinação a 90°

O produto roda 355° e inclina 90°, o que proporciona versatilidade para iluminar objetos ou áreas específicas.

2. Sensor ON/OFF

Está disponível uma versão com sensor ON/OFF que proporciona mais comodidade.

3. Porta USB

Graças à porta USB é possível carregar o seu dispositivo móvel.





GLAM /W E



Características do produto

Corpo

Alumínio

**Acabamento**

Revestido a epóxi-poliéster

230V/50Hz

Sistema ótico

Lente

**Fonte de luz**

LED, RG1, CRI>80, MacAdam Step ≤3

Vida útil LED

75.000h @ L90, B10, Ta 25°C

**Fonte de alimentação**

Driver LED 220-240V-50/60Hz incluído

01. Selecionar versão

GLAM /W E

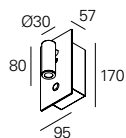

Lente (Não incluída)

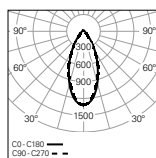

UGR
≤19

W
5

lm
output
228

74x122

CÓDIGO*
90089L003E♣♣♣

GLAM /W E

- Para completar o produto é necessário encomendar sistema ótico em separado.
- Os valores indicados são referentes a lentes de 47°.



*Substitua os símbolos para completar o código

Cor ¹	♣
□ Branco	W
■ Cinzento	G
■ Preto	B
■ Sahara	0
■ Mist	1
■ Carbon	I
■ Autumn	L
■ Rusty chain	R
■ Jungle	N
■ Golden eye	D
■ Old rose	5
■ Copper	7

Temp. de Cor	♦
2700K	2
4000K	0

Botão ON/OFF	♣
Standard ²	00
Sensor ³	56

¹ Ver página 246.

² Versão com botão ON/OFF standard.

³ Versão com sensor de movimento ON/OFF.

02. Selecionar opções

OPÇÕES	Código
Sistema ótico	
Lente de 14°	926200
Lente de 47°	926201
Lente oval	926202



Detalhes do produto



Lentes 14°, 47° ou oval



Sistema de fixação da lente



Efeito de luz com lente de 14°



Efeito de luz com lente de 47°



Efeito de luz com lente oval



Botão ON/OFF standard



Sensor ON/OFF



GLAM /W



Características do produto

Corpo

Alumínio

Acabamento

Revestido a epóxi-poliéster

Sistema ótico

Lente

Fonte de luz

LED, RG1, CRI>80, MacAdam Step ≤3

Vida útil LED

75.000h @ L90, B10, Ta 25°C

Fonte de alimentação

Driver LED 220-240V-50/60Hz incluído



230V/50Hz



IP 20

650°C

01. Selecionar versão

LEFT - Projetor no lado esquerdo

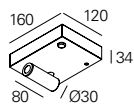

Lente (Não incluída)

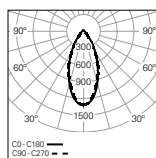

UGR
≤19

W
5

lm
output
228

CÓDIGO*
90078L003E♣♣♣



*Substitua os símbolos para completar o código

Cor ¹	♣
□ Branco	W
■ Cinzento	G
■ Preto	B
■ Sahara	0
■ Mist	1
■ Carbon	I
■ Autumn	L
■ Rusty chain	R
■ Jungle	N
■ Golden eye	D
■ Old rose	5
■ Copper	7

RIGHT - Projetor no lado direito

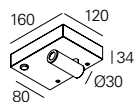

Lente (Não incluída)

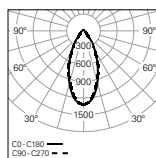

UGR
≤19

W
5

lm
output
228

CÓDIGO*
90070L003E♣♣♣

Temp. de Cor	♦
2700K	2
4000K	0

Botão ON/OFF	♣
Standard ²	00
USB ³	55
Sensor ⁴	56
Sensor + USB ⁵	57

LEFT | RIGHT

- Para completar o produto é necessário encomendar sistema ótico em separado.
- Os valores indicados são referentes a lentes de 47°.

¹ Ver página 246.

² Versão com botão ON/OFF standard.

³ Versão com porta USB.

⁴ Versão com sensor de movimento ON/OFF.

⁵ Versão com sensor de movimento ON/OFF e porta USB.

02. Selecionar opções

OPÇÕES	Código
Sistema ótico	
Lente de 14°	926200
Lente de 47°	926201
Lente oval	926202



Detalhes do produto



Lentes 14°, 47° ou oval



Sistema de fixação da lente



Efeito de luz com lente de 14°



Efeito de luz com lente de 47°



Efeito de luz com lente oval



Botão ON/OFF standard



Porta USB



Sensor ON/OFF



Versão de calha

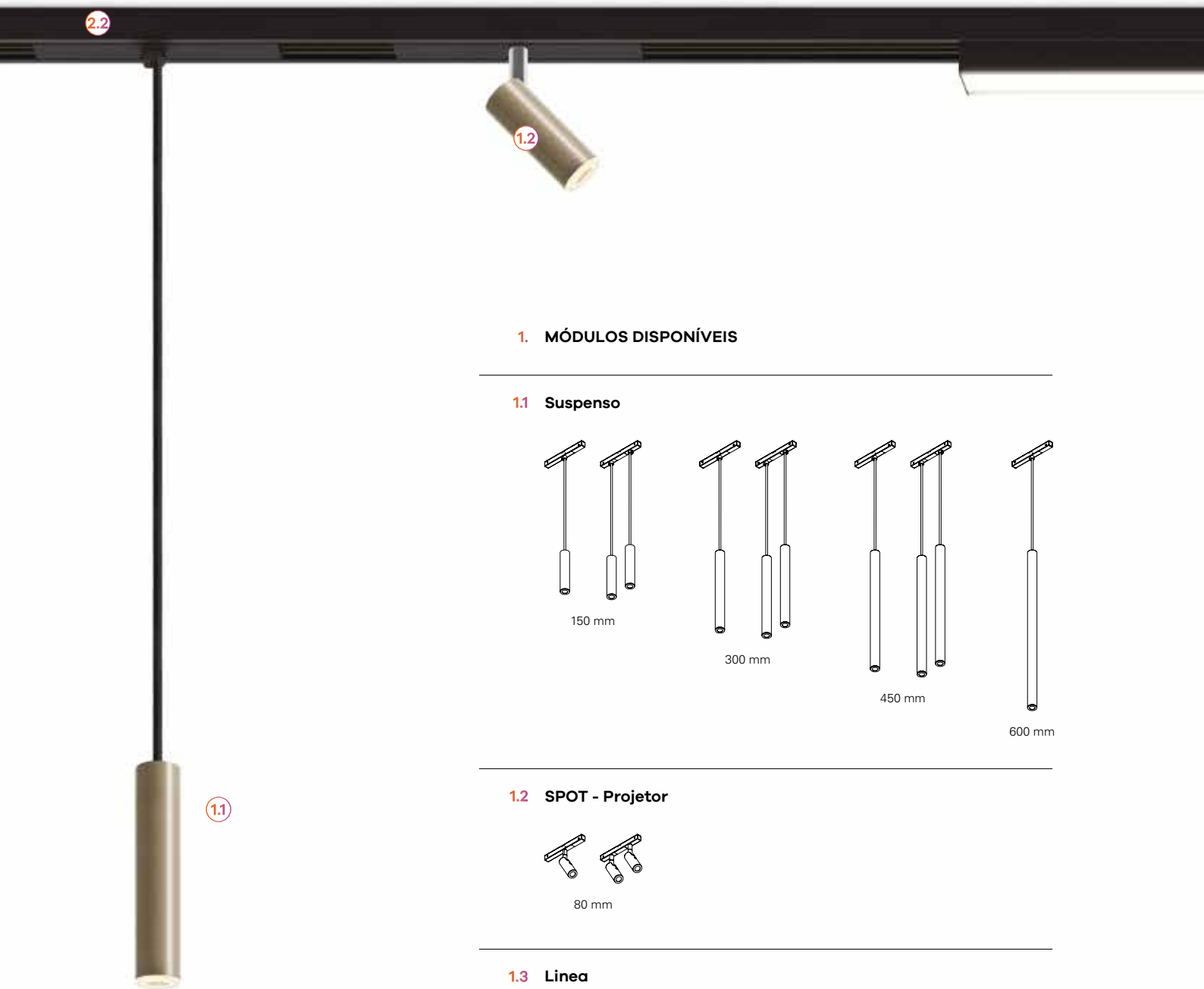

1. MÓDULOS DISPONÍVEIS

1.1 Suspensão

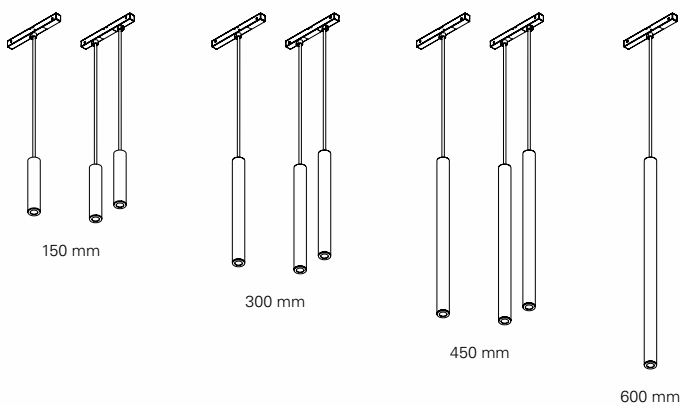

1.2 SPOT - Projektor

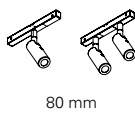

1.3 Linea

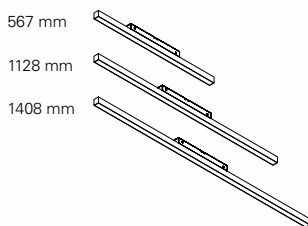

1.3

2. SISTEMA DE CALHA

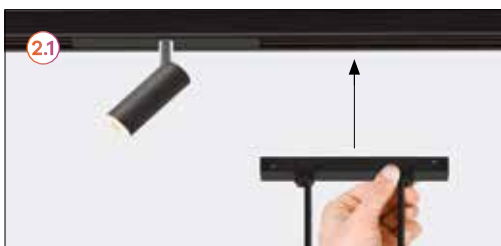

2.1 Encastrar



37x33 mm



2.2 Saliente ou suspensa



26x21 mm

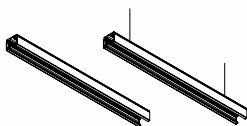

1.1

GLAM 48V



Características do produto

Corpo

Alumínio

Acabamento

Revestido a epóxi-poliéster em preto

Sistema ótico

/S e Spot: Lente

Linea: bOPTICS - Refletor simétrico

Linea: bLINE - Difusor opalino

Fonte de luz

/S e Spot: LED, RG1, CRI>80,

MacAdam Step ≤3

Linea: LED, RG1, CRI>90, MacAdam Step ≤3

Vida útil LED

/S e Spot: 75.000h @ L90, B10, Ta 25°C

Linea: 50.000h @ L90, B10, Ta 25°C

Fonte de alimentação

Não incluída

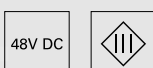
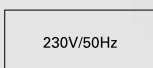

01. Seleccionar sistema de calha

TRACK SYSTEM - SISTEMA DE CALHA 48V

Encastrar

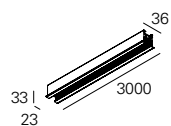

3000x27

CÓDIGO*
927801

Saliente ou suspensa

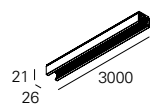

CÓDIGO*
927800

TRACK SYSTEM - SISTEMA DE CALHA

- Para completar o produto é necessário encomendar fonte de alimentação em separado.
- Acabamento anodizado em preto.
- A distância máxima entre o transformador e a calha é de 10000 mm.

02. Selecionar módulo

/S - Suspense

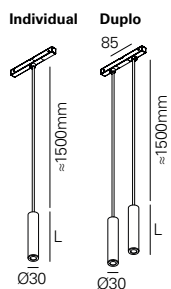

Lente (Não incluída)

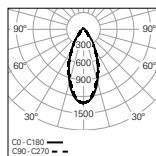

TIPO	UGR	W	lm output	lm/W	Lmm	CÓDIGO*
Individual	≤19	2	228	114	150	90835L150▼▲◆00
Individual	≤19	2	228	114	300	90835L300▼▲◆000
Individual	≤19	2	228	114	450	90835L450▼▲◆000
Individual	≤19	2	228	114	600	90835L600▼▲◆000
Duplo	≤19	4	456	114	150	90835L15D▼▲◆000
Duplo	≤19	4	456	114	300	90835L30D▼▲◆000
Duplo	≤19	4	456	114	450	90835L45D▼▲◆000

/S - Suspense

- Cabo de alimentação em tecido preto com 1500 mm incluído.
- Para completar o produto é necessário encomendar sistema ótico em separado.
- Os valores indicados são referentes a lentes de 47°.

SPOT - Projetor

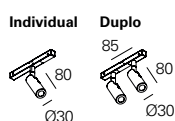

Lente (Não incluída)

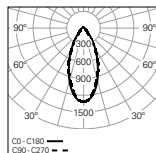

SPOT	UGR	W	lm output	lm/W	CÓDIGO*
Individual	≤19	2	228	114	90836L080▼▲◆000
Duplo	≤19	4	456	114	90836L08D▼▲◆000

SPOT - Projetor

- Para completar o produto é necessário encomendar sistema ótico em separado.
- Os valores indicados são referentes a lentes de 47°.

LINEA

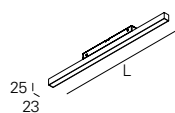

bOPTICS - Refletor simétrico

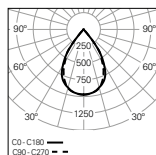

W	lm output	lm/W	Lmm	CÓDIGO*
11	867	79	567	90838L600▼00◆00
21	1734	83	1128	90838L120▼00◆00

bLINE - Difusor opalino

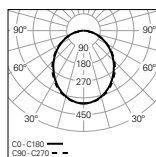

W	lm output	lm/W	Lmm	CÓDIGO*
11	1077	98	567	90837L600▼00◆00
23	2153	94	1128	90837L120▼00◆00
29	2692	93	1408	90837L150▼00◆00



*Substitua os símbolos para completar o código

Fonte de alimentação ▼

HF E

DALI H

Cor ¹ ▲

□ Branco	W
■ Cinzento	G
■ Preto	B
■ Sahara	0
■ Mist	1
■ Carbon	I
■ Autumn	L
■ Rusty chain	R
■ Jungle	N
■ Golden eye	D
■ Old rose	5
■ Copper	7

Temp. de Cor ◆

2700K CRI>80 ²	2
4000K CRI>80 ²	0
2700K CRI>90	D
4000K CRI>90	A

03. Selecionar opções

OPÇÕES	Código
Sistema ótico	
Lente de 14°	926200
Lente de 47°	926201
Lente oval	926202
• Para completar o produto na versão duplo é necessário encomendar 2 lentes.	
Transformador de 48V	
Potência de 75W	965719
Potência de 100W	965720
Potência de 150W	965721
Topo de alimentação	
HF / DALI	927850
Start kit - topo início/fim	
Encastrar sem furo (x1)	927810
Saliente sem furo (x1)	927811
Saliente com furo (x1)	927812
• Parafusos incluídos.	
União de alimentação	
HF / DALI	927860
União para perfil	
Encastrar	927820
• União de perfil em aço.	
Saliente	927821
• União de perfil em alumínio.	
Kit de fixação	
Encastrar	927830
• Kit de fixação em aço zincado.	
Kit de suspensão	
	927840
• 2 fixações e 2 suspensões incluídas.	
Projetos à medida	
• Sob consulta.	



Detalhes do produto



Lentes 14°, 47° ou oval



Sistema de fixação da lente



Efeito de luz com lente de 14°



Efeito de luz com lente de 47°



Efeito de luz com lente oval



Módulos com sistema de conexão rápida



Sistema de calha trimless



Sistema de calha saliente ou suspenso



/S - suspensão



SPOT - projetor



LINEA - bOPTICS



LINEA - bLINE







ELI 50

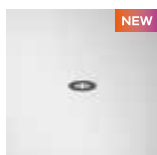

ELI 50 / E 1
284

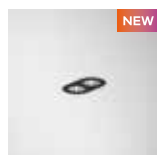

ELI 50 / E 2
286

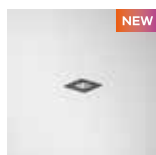

ELI 50 Sq / E 1
288



ELI 50 Sq / E 2
290

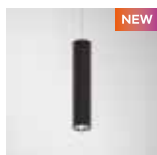

ELI 50
294

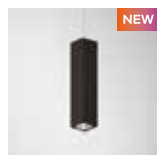

ELI 50 Sq
296

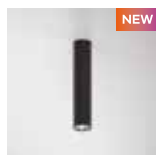

ELI 50 / C
300



ELI 50 Sq / C
302

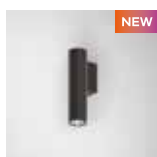

ELI 50 / W
304



ELI 50 Sq / W
306



ELI 50 / W D/I
308



ELI 50 Sq / W D/I
310

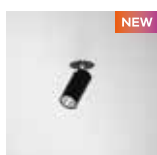

ELI 50 Spot / E 1
314

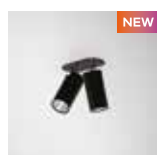

ELI 50 Spot / E 2
316

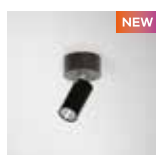

ELI 50 Spot / C
318



ELI 50 Spot Track
320



Tipos de aplicação



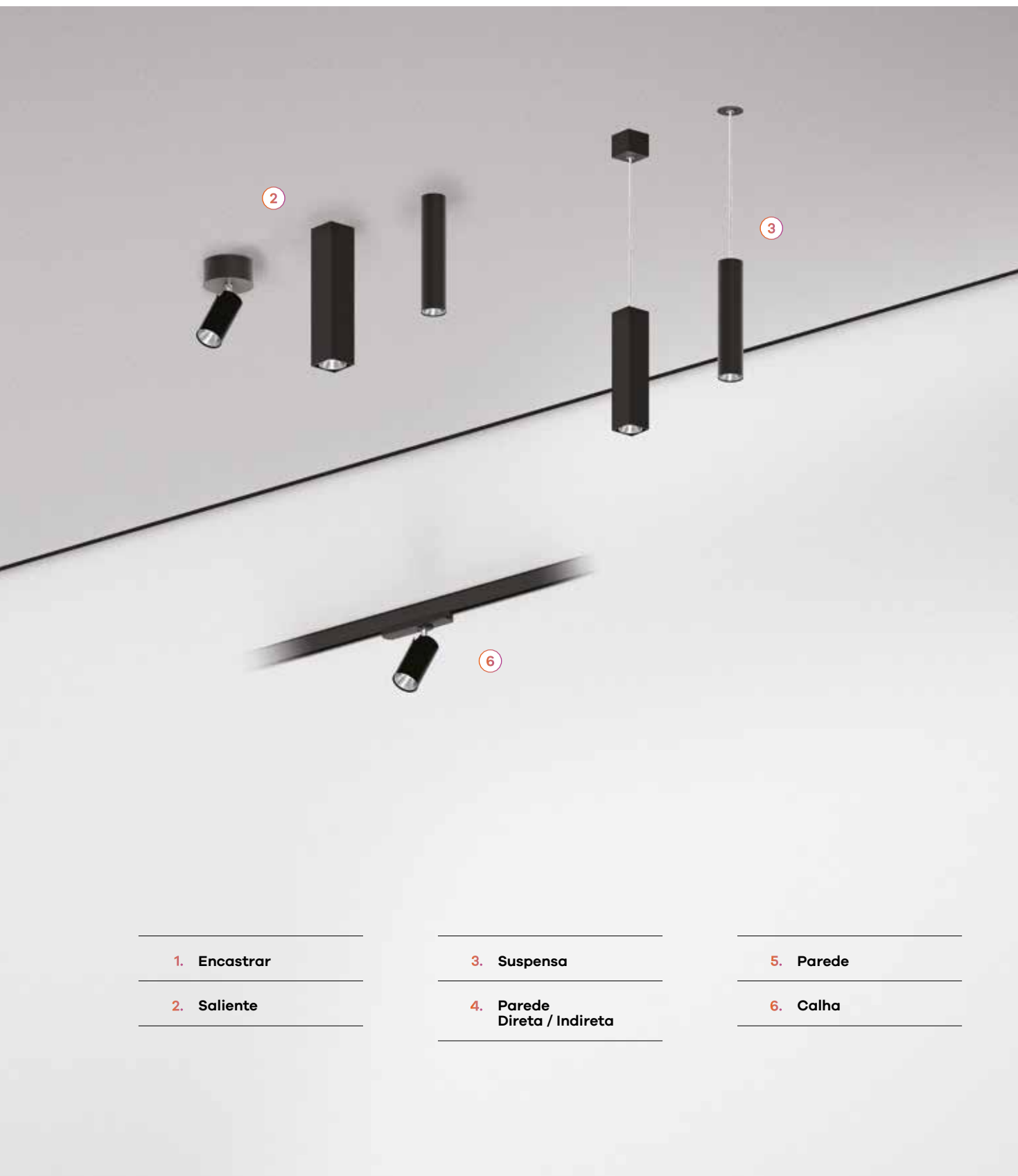

1. Encastrar

2. Saliente

3. Suspensa

**4. Parede
Direta / Indireta**

5. Parede

6. Calha

ELI 50 /E 1



Características do produto

Corpo

Alumínio

Acabamento

Revestido a epóxi-poliéster

Sistema ótico

PB - Refletor brilhante

Fonte de luz

LED, RG1, CRI>90, MacAdam Step ≤3

Vida útil LED

60.000h @ L80, B10, Ta 25°C

Fonte de alimentação

Não incluída

Espessura do teto

Para tetos entre 1-25 mm



01. Selecionar versão

ELI 50 / E 1



PB - Refletor brilhante - 20°

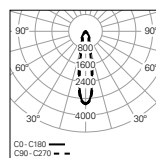

W	lm output	lm/W	mA	Ø	CÓDIGO*
5	747	149	150	Ø65	90695L0010▲0♦20
9	1168	130	250	Ø65	90694L0010▲0♦20

PB - Refletor brilhante - 50°

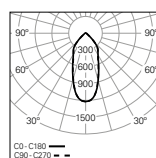

W	lm output	lm/W	mA	Ø	CÓDIGO*
5	724	145	150	Ø65	90695L0010▲0♦50
9	1144	127	250	Ø65	90694L0010▲0♦50



*Substitua os símbolos para completar o código

Cor ▲
 Branco W
 Preto B

Temp. de Cor ♦
 3000K 3
 4000K 0

ELI 50 / E 1

• Para completar o produto é necessário encomendar fonte de alimentação em separado.

02. Selecionar opções

OPÇÕES	Código
--------	--------

Fonte de alimentação HF

Driver 6,3W 10-42V 150mA HF	900000E
Driver 10,5W 10-42V 250mA HF	900002E

Fonte de alimentação DALI

Driver 7,8W 09-52V 150mA DALI+ PUSH	900100H
Driver 13W 09-52V 250mA DALI+ PUSH	900102H

Cabo de segurança em aço

L1500 mm	955010
----------	--------

ELI 50 / E 2



Características do produto

Corpo

Alumínio

**Acabamento**

Revestido a epóxi-poliéster

**Sistema ótico**

PB - Refletor brilhante

**Fonte de luz**

LED, RG1, CRI>90, MacAdam Step ≤3

Vida útil LED

60.000h @ L80, B10, Ta 25°C

Fonte de alimentação

Não incluída

Espessura do teto

Para tetos entre 1-25 mm

01. Selecionar versão

ELI 50 / E 2



PB - Refletor brilhante - 20°

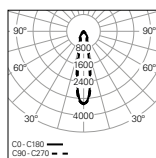

W	lm output	lm/W	mA	Ø	CÓDIGO*
10	1494	149	300	Ø60X120	90695L0020▲0◆20
17	2336	137	500	Ø60X120	90694L0020▲0◆20

PB - Refletor brilhante - 50°

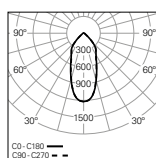

W	lm output	lm/W	mA	Ø	CÓDIGO*
10	1448	145	300	Ø60X120	90695L0020▲0◆50
17	2288	135	500	Ø60X120	90694L0020▲0◆50



*Substitua os símbolos para completar o código

Cor	◆
□ Branco	W
■ Preto	B

Temp. de Cor	◆
3000K	3
4000K	0

ELI 50 / E 2

- Para completar o produto é necessário encomendar fonte de alimentação em separado.

02. Selecionar opções

OPÇÕES

OPÇÕES	Código
Fonte de alimentação HF	
Driver 12,6W 10-42V 300mA HF	900003E
Driver 21W 10-42V 500mA HF	900007E
Fonte de alimentação DALI	
Driver 15,6W 09-52V 300mA DALI+ PUSH	900103H
Driver 26W 09-52V 500mA DALI+ PUSH	900107H
Cabo de segurança em aço	
L1500 mm	955010

ELI 50 Sq /E 1



Características do produto

Corpo

Alumínio

**Acabamento**

Revestido a epóxi-poliéster

**Sistema ótico**

PB - Refletor brilhante

**Fonte de luz**

LED, RG1, CRI>90, MacAdam Step ≤3

Vida útil LED

60.000h @ L80, B10, Ta 25°C

Fonte de alimentação

Não incluída

Espessura do teto

Para tetos entre 1-25 mm

01. Selecionar versão

ELI 50 Sq / E 1



PB - Refletor brilhante - 20°

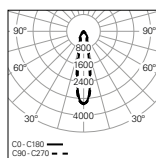

W	lm output	lm/W	mA	Ø	CÓDIGO*
5	747	149	150	Ø65	90697L0010▲0♦20
9	1168	130	250	Ø65	90696L0010▲0♦20

CG - C180 —
C90 - C270 - -

PB - Refletor brilhante - 50°

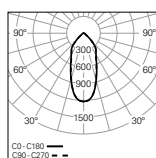

W	lm output	lm/W	mA	Ø	CÓDIGO*
5	724	145	150	Ø65	90697L0010▲0♦50
9	1144	127	250	Ø65	90696L0010▲0♦50

CG - C180 —
C90 - C270 - -



*Substitua os símbolos para completar o código

Cor	Simb.
□ Branco	W
■ Preto	B

Temp. de Cor	Simb.
3000K	3
4000K	0

ELI 50 Sq / E 1

- Para completar o produto é necessário encomendar fonte de alimentação em separado.

02. Selecionar opções

OPÇÕES

OPÇÕES	Código
Fonte de alimentação HF	
Driver 6,3W 10-42V 150mA HF	900000E
Driver 10,5W 10-42V 250mA HF	900002E
Fonte de alimentação DALI	
Driver 7,8W 09-52V 150mA DALI+ PUSH	900100H
Driver 13W 09-52V 250mA DALI+ PUSH	900102H
Cabo de segurança em aço	
L1500 mm	955010

ELI 50 Sq /E 2



Características do produto

Corpo

Alumínio



Acabamento

Revestido a epóxi-poliéster



Sistema ótico

PB - Refletor brilhante

Fonte de luz

LED, RG1, CRI>90, MacAdam Step ≤3



Vida útil LED

60.000h @ L80, B10, Ta 25°C

Fonte de alimentação

Não incluída

Espessura do teto

Para tetos entre 1-25 mm

01. Selecionar versão

ELI 50 Sq / E 2

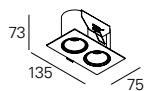

PB - Refletor brilhante - 20°

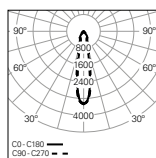

W	lm output	lm/W	mA	Ø	CÓDIGO*
10	1494	149	300	Ø60X120	90697L0020▲0◆20
17	2336	137	500	Ø60X120	90696L0020▲0◆20

CO - C180 —
C90 - C270 - -

PB - Refletor brilhante - 50°

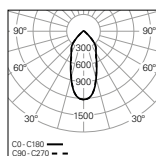

W	lm output	lm/W	mA	Ø	CÓDIGO*
10	1448	145	300	Ø60X120	90697L0020▲0◆50
17	2288	135	500	Ø60X120	90696L0020▲0◆50

CO - C180 —
C90 - C270 - -



*Substitua os símbolos para completar o código

Cor ▲
 Branco W
 Preto B

Temp. de Cor ◆
 3000K 3
 4000K 0

ELI 50 Sq / E 2

- Para completar o produto é necessário encomendar fonte de alimentação em separado.

02. Selecionar opções

OPÇÕES

Código

Fonte de alimentação HF

Driver 12,6W 10-42V 300mA HF	900003E
Driver 21W 10-42V 500mA HF	900007E

Fonte de alimentação DALI

Driver 15,6W 09-52V 300mA DALI+ PUSH	900103H
Driver 26W 09-52V 500mA DALI+ PUSH	900107H

Cabo de segurança em aço

L1500 mm	955010
----------	--------





ELI 50



Características do produto

Corpo

Alumínio

**Acabamento**

Revestido a epóxi-poliéster

230V/50Hz

Sistema ótico

PB - Refletor brilhante



IP 20

Fonte de luz

LED, RG1, CRI>90, MacAdam Step ≤3

Vida útil LED

60.000h @ L80, B10, Ta 25°C

650°C

Fonte de alimentação

Driver LED 220-240V-50/60Hz incluído

01. Selecionar versão

ELI 50

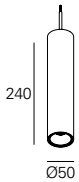

PB - Refletor brilhante - 20°

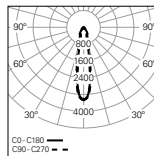

W	lm output	lm/W	CÓDIGO*
7	747	107	90679L240▼▲0◆20
11	1168	106	90678L240▼▲0◆20

PB - Refletor brilhante - 50°

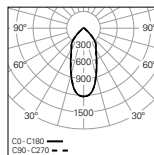

W	lm output	lm/W	CÓDIGO*
7	724	103	90679L240▼▲0◆50
11	1144	104	90678L240▼▲0◆50



*Substitua os símbolos para completar o código

Fonte de alimentação ▼
HF E
DALI H

Cor ▲
□ Branco W
■ Preto B

Temp. de Cor ◆
3000K 3
4000K 0

ELI 50

• Para completar o produto é necessário encomendar cabo e caixa de alimentação em separado.

02. Selecionar opções

OPÇÕES

Cabo de alimentação transparente

Descrição	Código*
L1500 mm - 3 x 0,75 mm ²	940400
L1500 mm - 5 x 0,75 mm ²	940500
L3000 mm - 3 x 0,75 mm ²	940401
L3000 mm - 5 x 0,75 mm ²	940501
L6000 mm - 3 x 0,75 mm ²	940402
L6000 mm - 5 x 0,75 mm ²	940507

Caixa de alimentação circular

Saliente T41 D50	45 Ø50	978805▲
Encastrar T42 D50	Ø40 32 Ø50	978804▲



*Substitua os símbolos para completar o código

Cor ▲
□ Branco W
■ Preto B



Detalhes do produto



Caixas de alimentação

ELI 50 Sq



Características do produto

Corpo

Alumínio

Acabamento

Revestido a epóxi-poliéster

Sistema ótico

PB - Refletor brilhante

Fonte de luz

LED, RG1, CRI>90, MacAdam Step ≤3

Vida útil LED

60.000h @ L80, B10, Ta 25°C

Fonte de alimentação

Driver LED 220-240V-50/60Hz incluído



230V/50Hz



IP 20

650°C

01. Selecionar versão

ELI 50 Sq

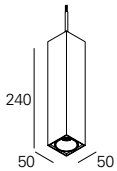

PB - Refletor brilhante - 20°

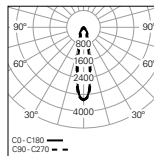

W	lm output	lm/W	CÓDIGO*
7	747	107	90687L240▼▲0◆20
11	1168	106	90686L240▼▲0◆20

PB - Refletor brilhante - 50°

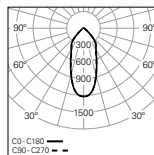

W	lm output	lm/W	CÓDIGO*
7	724	103	90687L240▼▲0◆50
11	1144	104	90686L240▼▲0◆50



*Substitua os símbolos para completar o código

Fonte de alimentação ▼
 HF E
 DALI H

Cor ▲
 □ Branco W
 ■ Preto B

Temp. de Cor ◆
 3000K 3
 4000K 0

ELI 50 Sq

• Para completar o produto é necessário encomendar cabo e caixa de alimentação em separado.

02. Selecionar opções

OPÇÕES Código*

Cabo de alimentação transparente

L1500 mm - 3 x 0,75 mm ²	940400
L1500 mm - 5 x 0,75 mm ²	940500
L3000 mm - 3 x 0,75 mm ²	940401
L3000 mm - 5 x 0,75 mm ²	940501
L6000 mm - 3 x 0,75 mm ²	940402
L6000 mm - 5 x 0,75 mm ²	940507

Caixa de alimentação quadrada

Saliente T46 Q50	47		50	978807▲	
Encastrar T47 Q50	Ø40	32		50	978808▲



*Substitua os símbolos para completar o código

Cor ▲
 □ Branco W
 ■ Preto B



Detalhes do produto



Caixas de alimentação



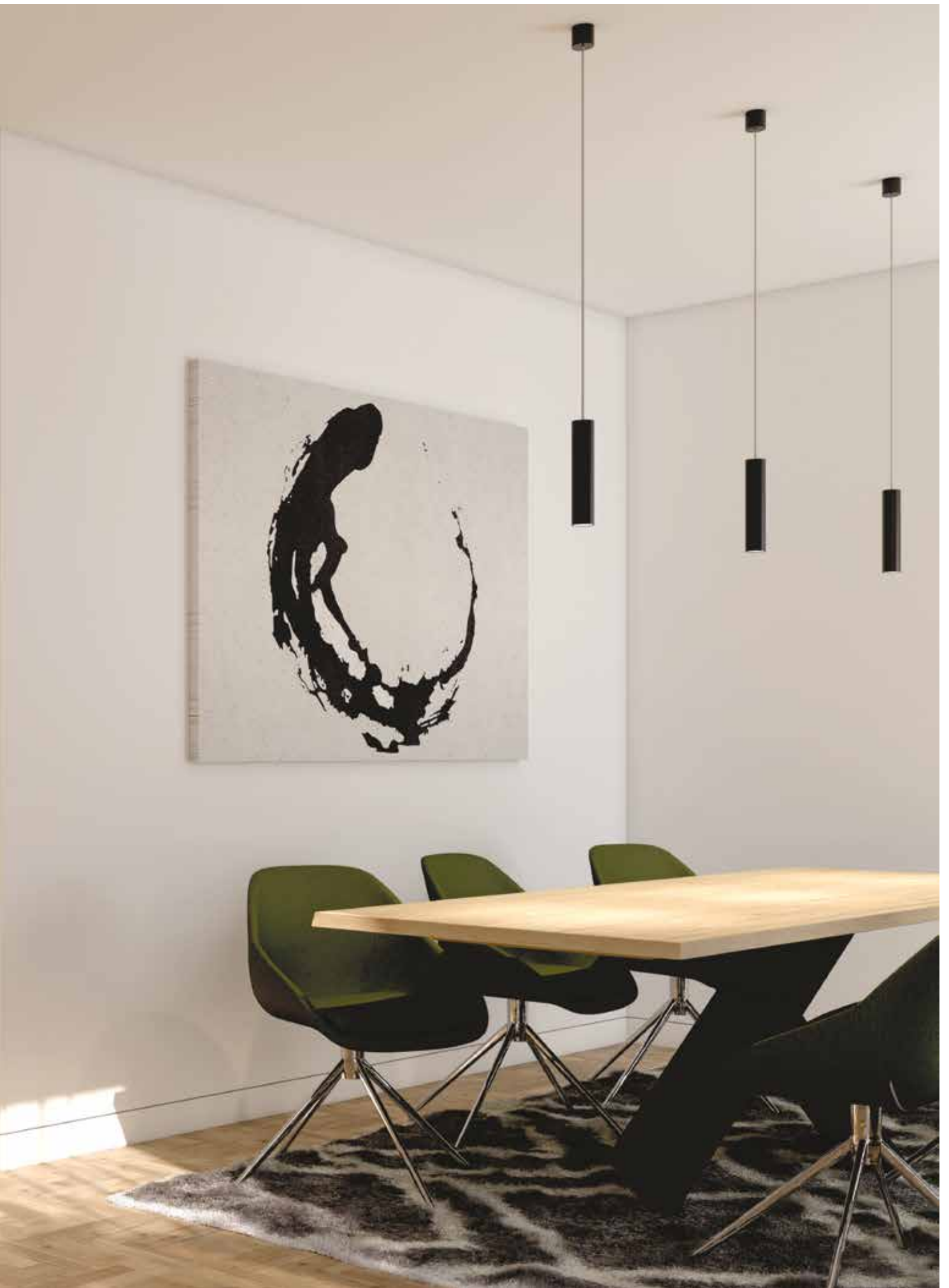

ELI 50 /C



Características do produto

Corpo

Alumínio

Acabamento

Revestido a epóxi-poliéster

Sistema ótico

PB - Refletor brilhante

Fonte de luz

LED, RG1, CRI>90, MacAdam Step ≤3

Vida útil LED

60.000h @ L80, B10, Ta 25°C

Fonte de alimentação

Driver LED 220-240V-50/60Hz incluído



230V/50Hz



IP 20

650°C

01. Seleccionar versão



ELI 50 / C

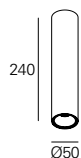

PB - Refletor brilhante - 20°

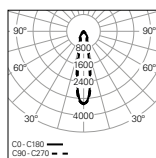

W	lm output	lm/W	CÓDIGO*
7	747	107	90681L240▼▲0◆20
11	1168	106	90680L240▼▲0◆20

*Substitua os símbolos para completar o código

Fonte de alimentação	▼
HF	E
DALI	H

Cor	▲
□ Branco	W
■ Preto	B

PB - Refletor brilhante - 50°

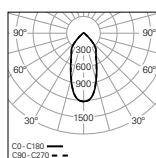

W	lm output	lm/W	CÓDIGO*
7	724	103	90681L240▼▲0◆50
11	1144	104	90680L240▼▲0◆50

Temp. de Cor	◆
3000K	3
4000K	0

ELI 50 Sq /C



Características do produto

Corpo

Alumínio

Acabamento

Revestido a epóxi-poliéster

Sistema ótico

PB - Refletor brilhante

Fonte de luz

LED, RG1, CRI>90, MacAdam Step ≤3

Vida útil LED

60.000h @ L80, B10, Ta 25°C

Fonte de alimentação

Driver LED 220-240V-50/60Hz incluído



230V/50Hz



IP 20

650°C

01. Seleccionar versão



ELI 50 Sq /C

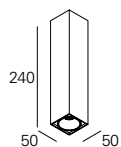

PB - Refletor brilhante - 20°

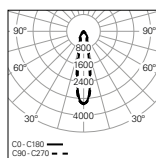

W
7
11

lm output
747
1168

lm/W
107
106

CÓDIGO*

90689L240▼▲0◆20
90688L240▼▲0◆20

*Substitua os símbolos para completar o código

Fonte de alimentação ▼
HF E
DALI H

Cor ▲
□ Branco W
■ Preto B

PB - Refletor brilhante - 50°

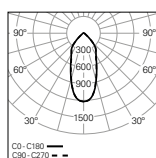

W
7
11

lm output
724
1144

lm/W
103
104

CÓDIGO*

90689L240▼▲0◆50
90688L240▼▲0◆50

Temp. de Cor ◆
3000K 3
4000K 0

ELI 50 /W



Características do produto

Corpo

Alumínio

Acabamento

Revestido a epóxi-poliéster

Sistema ótico

PB - Refletor brilhante

Fonte de luz

LED, RG1, CRI>90, MacAdam Step ≤3

Vida útil LED

60.000h @ L80, B10, Ta 25°C

Fonte de alimentação

Driver LED 220-240V-50/60Hz incluído



230V/50Hz



IP 20

650°C

01. Selecionar versão



ELI 50 /W

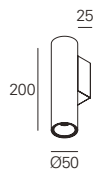

PB - Refletor brilhante - 20°

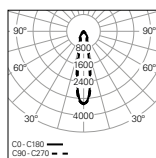

W	lm output	lm/W	CÓDIGO*
7	747	107	90683L200▼▲◆20
11	1168	106	90682L200▼▲◆20

*Substitua os símbolos para completar o código

Fonte de alimentação	
HF	E
DALI	H

Cor	
□ Branco	W
■ Preto	B

PB - Refletor brilhante - 50°

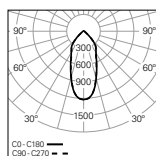

W	lm output	lm/W	CÓDIGO*
7	724	103	90683L200▼▲◆50
11	1144	104	90682L200▼▲◆50

Temp. de Cor	
3000K	3
4000K	0

ELI 50 Sq /W



Características do produto

Corpo

Alumínio

Acabamento

Revestido a epóxi-poliéster

Sistema ótico

PB - Refletor brilhante

Fonte de luz

LED, RG1, CRI>90, MacAdam Step ≤3

Vida útil LED

60.000h @ L80, B10, Ta 25°C

Fonte de alimentação

Driver LED 220-240V-50/60Hz incluído



230V/50Hz



IP 20

650°C

01. Seleccionar versão



ELI 50 Sq /W

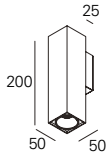

PB - Refletor brilhante - 20°

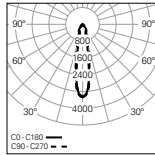

W
7
11

lm output
747
1168

lm/W
107
106

CÓDIGO*
90691L200▼▲0◆20
90690L200▼▲0◆20

*Substitua os símbolos para completar o código

Fonte de alimentação ▼
HF E
DALI H

Cor ▲
□ Branco W
■ Preto B

PB - Refletor brilhante - 50°

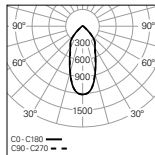

W
7
11

lm output
724
1144

lm/W
103
104

CÓDIGO*
90691L200▼▲0◆50
90690L200▼▲0◆50

Temp. de Cor ◆
3000K 3
4000K 0

ELI 50 /W D/I



Características do produto

Corpo

Alumínio

Acabamento

Revestido a epóxi-poliéster

Sistema ótico

PB - Refletor brilhante

Fonte de luz

LED, RG1, CRI>90, MacAdam Step ≤3

Vida útil LED

60.000h @ L80, B10, Ta 25°C

Fonte de alimentação

Driver LED 220-240V-50/60Hz incluído



230V/50Hz



IP 20

650°C

01. Seleccionar versão



ELI 50 /W D/I

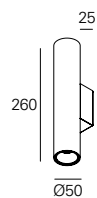

PB - Refletor brilhante - 20°

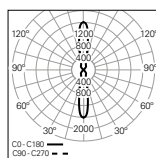

W
10

**lm
output**
1254

lm/W
125

CÓDIGO*
90684L260▼▲0♦20

*Substitua os símbolos para completar o código

Fonte de alimentação ▼
HF E
DALI H

Cor ▲
□ Branco W
■ Preto B

PB - Refletor brilhante - 50°

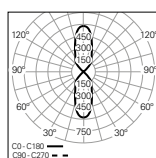

W
10

**lm
output**
1214

lm/W
121

CÓDIGO*
90684L260▼▲0♦50

Temp. de Cor ♦
3000K 3
4000K 0

ELI 50 Sq /W D/I



Características do produto

Corpo

Alumínio

Acabamento

Revestido a epóxi-poliéster

Sistema ótico

PB - Refletor brilhante

Fonte de luz

LED, RG1, CRI>90, MacAdam Step ≤3

Vida útil LED

60.000h @ L80, B10, Ta 25°C

Fonte de alimentação

Driver LED 220-240V-50/60Hz incluído



230V/50Hz



IP 20

650°C

01. Seleccionar versão



ELI 50 Sq /W D/I

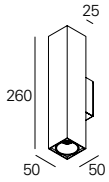

PB - Refletor brilhante - 20°

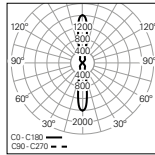

W
10

lm output
1254

lm/W
125

CÓDIGO*
90692L260▼▲0♦20

*Substitua os símbolos para completar o código

Fonte de alimentação ▼
HF E
DALI H

Cor ▲
□ Branco W
■ Preto B

PB - Refletor brilhante - 50°

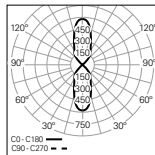

W
10

lm output
1214

lm/W
121

CÓDIGO*
90692L260▼▲0♦50

Temp. de Cor ♦
3000K 3
4000K 0





ELI 50 Spot /E 1



Características do produto

Corpo

Alumínio

**Acabamento**

Revestido a epóxi-poliéster

**Sistema ótico**

PB - Refletor brilhante

**Fonte de luz**

LED, RG1, CRI>90, MacAdam Step ≤3

Vida útil LED

60.000h @ L80, B10, Ta 25°C

**Fonte de alimentação**

Não incluída

Espessura do teto

Para tetos entre 1-25 mm

01. Selecionar versão

ELI 50 Spot / E 1

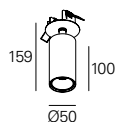

PB - Refletor brilhante - 20°

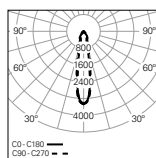

W	Im output	lm/W	mA	Ø	CÓDIGO*
5	747	149	150	Ø50	90703L0010▲0◆20
9	1168	130	250	Ø50	90702L0010▲0◆20

PB - Refletor brilhante - 50°

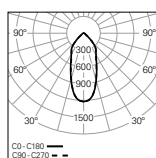

W	Im output	lm/W	mA	Ø	CÓDIGO*
5	724	145	150	Ø50	90703L0010▲0◆50
9	1144	127	250	Ø50	90702L0010▲0◆50

ELI 50 Spot / E 1

- Para completar o produto é necessário encomendar fonte de alimentação em separado.



*Substitua os símbolos para completar o código

Cor	▲
□ Branco	W
■ Preto	B

Temp. de Cor	◆
3000K	3
4000K	0

02. Selecionar opções

OPÇÕES

OPÇÕES	Código
Fonte de alimentação HF	
Driver 6,3W 10-42V 150mA HF	900000E
Driver 10,5W 10-42V 250mA HF	900002E
Fonte de alimentação DALI	
Driver 7,8W 09-52V 150mA DALI+ PUSH	900100H
Driver 13W 09-52V 250mA DALI+ PUSH	900102H
Cabo de segurança em aço	
L1500 mm	955010



Detalhes do produto



Rotação de 355° e inclinação de 90°

ELI 50 Spot /E 2



Características do produto

Corpo

Alumínio

**Acabamento**

Revestido a epóxi-poliéster

**Sistema ótico**

PB - Refletor brilhante

**Fonte de luz**

LED, RG1, CRI>90, MacAdam Step ≤3

Vida útil LED

60.000h @ L80, B10, Ta 25°C

**Fonte de alimentação**

Não incluída

Espessura do teto

Para tetos entre 1-25 mm

01. Selecionar versão

ELI 50 Spot / E 2

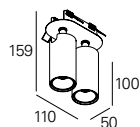

PB - Refletor brilhante - 20°

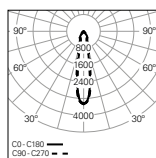

W	lm output	lm/W	mA	Ø	CÓDIGO*
10	1494	149	300	Ø45x105	90703L0020▲0♦20
17	2336	137	500	Ø45x105	90702L0020▲0♦20

PB - Refletor brilhante - 50°

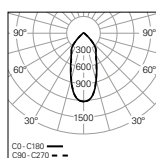

W	lm output	lm/W	mA	Ø	CÓDIGO*
10	1448	145	300	Ø45x105	90703L0020▲0♦50
17	2288	135	500	Ø45x105	90702L0020▲0♦50

ELI 50 Spot / E 2

- Para completar o produto é necessário encomendar fonte de alimentação em separado.



*Substitua os símbolos para completar o código

Cor	▲
□ Branco	W
■ Preto	B

Temp. de Cor	♦
3000K	3
4000K	0

02. Selecionar opções

OPÇÕES

OPÇÕES	Código
Fonte de alimentação HF	
Driver 12,6W 10-42V 300mA HF	900003E
Driver 21W 10-42V 500mA HF	900007E
Fonte de alimentação DALI	
Driver 15,6W 09-52V 300mA DALI+ PUSH	900103H
Driver 26W 09-52V 500mA DALI+ PUSH	900107H
Cabo de segurança em aço	
L1500 mm	955010



Detalhes do produto



Rotação de 355° e inclinação de 90°

ELI 50 Spot /C



Características do produto

Corpo

Alumínio

Acabamento

Revestido a epóxi-poliéster

Sistema ótico

PB - Refletor brilhante

Fonte de luz

LED, RG1, CRI>90, MacAdam Step ≤3

Vida útil LED

60.000h @ L80, B10, Ta 25°C

Fonte de alimentação

Driver LED 220-240V-50/60Hz incluído

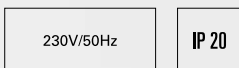

01. Selecionar versão



ELI 50 Spot /C

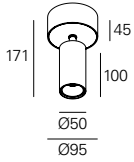

PB - Refletor brilhante - 20°

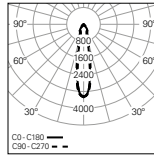

W	lm output	lm/W	CÓDIGO*
7	747	107	90701L100▼▲0◆20
11	1168	106	90700L100▼▲0◆20

CO-C180 —
C90-C270 - -

PB - Refletor brilhante - 50°

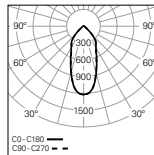

W	lm output	lm/W	CÓDIGO*
7	724	103	90701L100▼▲0◆50
11	1144	104	90700L100▼▲0◆50

CO-C180 —
C90-C270 - -

*Substitua os símbolos para completar o código

Fonte de alimentação ▼

HF	E
DALI	H

Cor ▲

□ Branco	W
■ Preto	B

Temp. de Cor ◆

3000K	3
4000K	0

Detalhes do produto



Rotação de 355° e inclinação de 90°

ELI 50 Spot Track



Características do produto

Corpo

Alumínio



Acabamento

Revestido a epóxi-poliéster

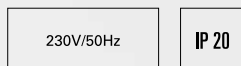

Sistema ótico

PB - Refletor brilhante



Fonte de luz

LED, RG1, CRI>90, MacAdam Step ≤3

Vida útil LED

60.000h @ L80, B10, Ta 25°C

Fonte de alimentação

Driver LED 220-240V-50/60Hz incluído

01. Selecionar versão

ELI 50 Spot Track

HF

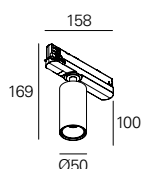

DALI

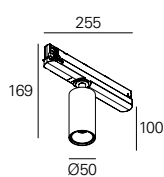

PB - Refletor brilhante - 20°

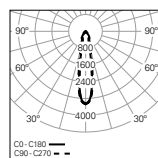

W
7
11

lm
output
747
1168

lm/W
106
106

CÓDIGO*

90699L100H▲0◆20
90698L100▼▲0◆20

PB - Refletor brilhante - 50°

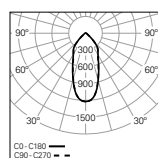

W
7
11

lm
output
724
1144

lm/W
103
104

CÓDIGO*

90699L100H▲0◆50
90698L100▼▲0◆50



*Substitua os símbolos para completar o código

Fonte de alimentação ▼
HF E
DALI H

Cor ▲
□ Branco W
■ Preto B

Temp. de Cor ◆
3000K 3
4000K 0

02. Selecionar opções

OPÇÕES

Sistema de calha

- Ver página 800.



Detalhes do produto



Rotação de 355° e inclinação de 90°



Acabamento em branco







ELI



ELI / E 1
328



ELI / E 2
330



ELI Sq / E 1
332

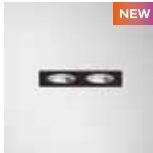

ELI Sq / E 2
334



ELI
338



ELI Sq
340

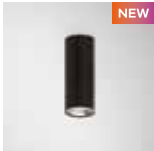

ELI / C
342



ELI Sq / C
344

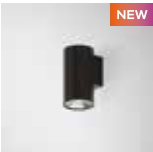

ELI / W
348



ELI Sq / W
350



ELI / W D/I
352



ELI Sq / W D/I
354



Tipos de aplicação





ELI / E 1



Características do produto

Corpo

Alumínio

Acabamento

Revestido a epóxi-poliéster

Sistema ótico

PB - Refletor brilhante

Fonte de luz

LED, RG1, CRI>90, MacAdam Step ≤3

Vida útil LED

50.000h @ L90, B10, Ta 25°C

Fonte de alimentação

Não incluída

Espessura do teto

Para tetos entre 1-25 mm



01. Selecionar versão



ELI / E 1

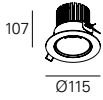

PB - Refletor brilhante - 35°

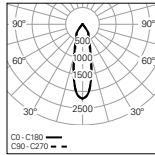

UGR	W	lm output	lm/W	mA	Ø	CÓDIGO*
≤19	5	706	141	150	Ø95	90661L0010▲0♦35
≤19	8	1161	145	250	Ø95	90654L0010▲0♦35

PB - Refletor brilhante - 60°

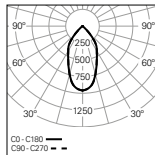

UGR	W	lm output	lm/W	mA	Ø	CÓDIGO*
≤22	5	706	141	150	Ø95	90661L0010▲0♦60
≤22	8	1161	145	250	Ø95	90654L0010▲0♦60

*Substitua os símbolos para completar o código

Cor	W
□ Branco	W
■ Preto	B

Temp. de Cor	♦
3000K	3
4000K	0

ELI / E 1

• Para completar o produto é necessário encomendar fonte de alimentação em separado.

02. Selecionar opções

OPÇÕES Código

Fonte de alimentação HF	
Driver 6,3W 10-42V 150mA HF	900000E
Driver 10,5W 10-42V 250mA HF	900002E

Fonte de alimentação DALI	
Driver 7,8W 09-52V 150mA DALI+ PUSH	900100H
Driver 13W 09-52V 250mA DALI+ PUSH	900102H

Cabo de segurança em aço	
L1500 mm	955010

ELI / E 2



Características do produto

Corpo

Alumínio

Acabamento

Revestido a epóxi-poliéster

Sistema ótico

PB - Refletor brilhante

Fonte de luz

LED, RG1, CRI>90, MacAdam Step ≤3

Vida útil LED

50.000h @ L90, B10, Ta 25°C

Fonte de alimentação

Não incluída

Espessura do teto

Para tetos entre 1-25 mm



01. Selecionar versão



ELI / E 2

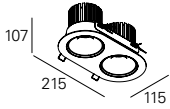

PB - Refletor brilhante - 35°

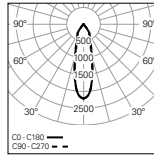

UGR	W	lm output	lm/W	mA	Ø	CÓDIGO*
≤19	10	1411	141	300	Ø95x195	90661L0020▲0♦35
≤19	16	2322	145	500	Ø95x195	90654L0020▲0♦35

*Substitua os símbolos para completar o código

Cor	W
□ Branco	W
■ Preto	B

Temp. de Cor	♦
3000K	3
4000K	0

PB - Refletor brilhante - 60°

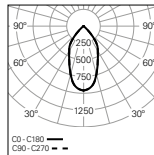

UGR	W	lm output	lm/W	mA	Ø	CÓDIGO*
≤22	10	1411	141	300	Ø95x195	90661L0020▲0♦60
≤22	16	2322	145	500	Ø95x195	90654L0020▲0♦60

ELI / E 2

• Para completar o produto é necessário encomendar fonte de alimentação em separado.

02. Selecionar opções

OPÇÕES	Código
--------	--------

Fonte de alimentação HF

Driver 12,6W 10-42V 300mA HF	900003E
Driver 21W 10-42V 500mA HF	900007E

Fonte de alimentação DALI

Driver 15,6W 09-52V 300mA DALI+ PUSH	900103H
Driver 26W 09-52V 500mA DALI+ PUSH	900107H

Cabo de segurança em aço

L1500 mm	955010
----------	--------

ELI Sq /E 1



Características do produto

Corpo

Alumínio

Acabamento

Revestido a epóxi-poliéster

Sistema ótico

PB - Refletor brilhante

Fonte de luz

LED, RG1, CRI>90, MacAdam Step ≤3

Vida útil LED

50.000h @ L90, B10, Ta 25°C

Fonte de alimentação

Não incluída

Espessura do teto

Para tetos entre 1-25 mm



01. Selecionar versão

ELI Sq /E 1

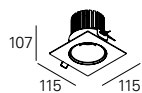

PB - Refletor brilhante - 35°

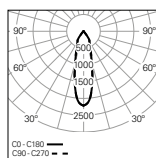

UGR	W	lm output	lm/W	mA	Ø	CÓDIGO*
≤19	5	706	141	150	Ø95	90673L0010▲0♦35
≤19	8	1161	145	250	Ø95	90655L0010▲0♦35

PB - Refletor brilhante - 60°

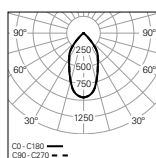

UGR	W	lm output	lm/W	mA	Ø	CÓDIGO*
≤22	5	706	141	150	Ø95	90673L0010▲0♦60
≤22	8	1161	145	250	Ø95	90655L0010▲0♦60



*Substitua os símbolos para completar o código

Cor	Simb.
□ Branco	W
■ Preto	B

Temp. de Cor	Simb.
3000K	3
4000K	0

ELI Sq /E 1

- Para completar o produto é necessário encomendar fonte de alimentação em separado.

02. Selecionar opções

OPÇÕES

OPÇÕES	Código
Fonte de alimentação HF	
Driver 6,3W 10-42V 150mA HF	900000E
Driver 10,5W 10-42V 250mA HF	900002E
Fonte de alimentação DALI	
Driver 7,8W 09-52V 150mA DALI+ PUSH	900100H
Driver 13W 09-52V 250mA DALI+ PUSH	900102H
Cabo de segurança em aço	
L1500 mm	955010

ELI Sq /E 2



Características do produto

Corpo

Alumínio

Acabamento

Revestido a epóxi-poliéster

Sistema ótico

PB - Refletor brilhante

Fonte de luz

LED, RG1, CRI>90, MacAdam Step ≤3

Vida útil LED

50.000h @ L90, B10, Ta 25°C

Fonte de alimentação

Não incluída

Espessura do teto

Para tetos entre 1-25 mm



01. Selecionar versão

ELI Sq / E 2

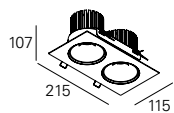

PB - Refletor brilhante - 35°

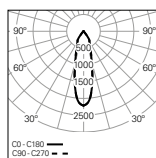

UGR	W	lm output	lm/W	mA	Ø	CODE*
≤19	10	1411	141	300	Ø95x195	90673L0020▲0♦35
≤19	16	2322	145	500	Ø95x195	90655L0020▲0♦35

PB - Refletor brilhante - 60°

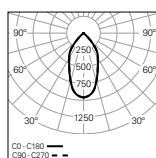

UGR	W	lm output	lm/W	mA	Ø	CODE*
≤22	10	1411	141	300	Ø95x195	90673L0020▲0♦60
≤22	16	2322	145	500	Ø95x195	90655L0020▲0♦60



*Substitua os símbolos para completar o código

Cor	◆
□ Branco	W
■ Preto	B

Temp. de Cor	◆
3000K	3
4000K	0

ELI Sq / E 2

• Para completar o produto é necessário encomendar fonte de alimentação em separado.

02. Selecionar opções

OPÇÕES

OPÇÕES	Código
Fonte de alimentação HF	
Driver 12,6W 10-42V 300mA HF	900003E
Driver 21W 10-42V 500mA HF	900007E
Fonte de alimentação DALI	
Driver 15,6W 09-52V 300mA DALI+ PUSH	900103H
Driver 26W 09-52V 500mA DALI+ PUSH	900107H
Cabo de segurança em aço	
L1500 mm	955010







Características do produto

Corpo

Alumínio

Acabamento

Revestido a epóxi-poliéster

Sistema ótico

PB - Refletor brilhante

Fonte de luz

LED, RG1, CRI>90, MacAdam Step ≤3

Vida útil LED

50.000h @ L90, B10, Ta 25°C

Fonte de alimentação

Driver LED 220-240V-50/60Hz incluído



230V/50Hz



IP 20

650°C

01. Selecionar versão

ELI

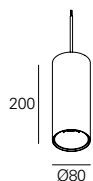

PB - Refletor brilhante - 35°

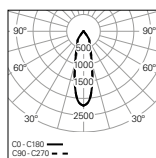

UGR	W	lm output	lm/W	CÓDIGO*
≤19	6	706	118	90671L200▼▲0◆35
≤19	9	1161	129	90564L200▼▲0◆35

PB - Refletor brilhante - 60°

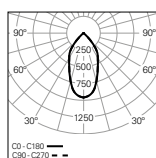

UGR	W	lm output	lm/W	CÓDIGO*
≤22	6	706	118	90671L200▼▲0◆60
≤22	9	1161	129	90564L200▼▲0◆60



*Substitua os símbolos para completar o código

Fonte de alimentação ▼
 HF E
 DALI H

Cor ▲
 Branco W
 Preto B

Temp. de Cor ◆
 3000K 3
 4000K 0

ELI

• Para completar o produto é necessário encomendar cabo e caixa de alimentação em separado.

02. Selecionar opções



OPÇÕES Código*

Cabo de alimentação transparente

L1500 mm - 3 x 0,75 mm ²	940400
L1500 mm - 5 x 0,75 mm ²	940500
L3000 mm - 3 x 0,75 mm ²	940401
L3000 mm - 5 x 0,75 mm ²	940501
L6000 mm - 3 x 0,75 mm ²	940402
L6000 mm - 5 x 0,75 mm ²	940507

Caixa de alimentação circular

Saliente T24 D95	45 Ø95	978600▲
Encastrar T5 D90	Ø70 33 Ø90	971300▲

*Substitua os símbolos para completar o código

Cor ▲
 Branco W
 Preto B



Detalhes do produto



Caixas de alimentação

ELI Sq

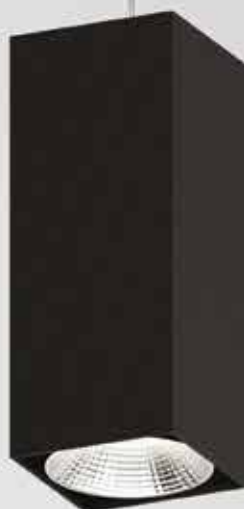

Características do produto

Corpo

Alumínio

Acabamento

Revestido a epóxi-poliéster

Sistema ótico

PB - Refletor brilhante

Fonte de luz

LED, RG1, CRI>90, MacAdam Step ≤ 3

Vida útil LED

50.000h @ L90, B10, Ta 25°C

Fonte de alimentação

Driver LED 220-240V-50/60Hz incluído



230V/50Hz



IP 20

650°C

01. Selecionar versão

ELI Sq

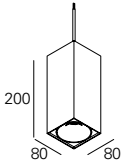

PB - Refletor brilhante - 35°

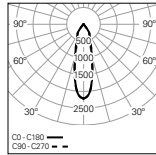

UGR	W	lm output	lm/W	CÓDIGO*
≤19	6	706	118	90676L200▼▲0◆35
≤19	9	1161	129	90566L200▼▲0◆35

PB - Refletor brilhante - 60°

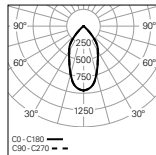

UGR	W	lm output	lm/W	CÓDIGO*
≤22	6	706	118	90676L200▼▲0◆60
≤22	9	1161	129	90566L200▼▲0◆60



*Substitua os símbolos para completar o código

Fonte de alimentação ▼
 HF E
 DALI H

Cor ▲
 Branco W
 Preto B

Temp. de Cor ◆
 3000K 3
 4000K 0

ELI Sq

• Para completar o produto é necessário encomendar cabo e caixa de alimentação em separado.

02. Selecionar opções







*Substitua os símbolos para completar o código

OPÇÕES Código*

Cabo de alimentação transparente

L1500 mm - 3 x 0,75 mm ²	940400
L1500 mm - 5 x 0,75 mm ²	940500
L3000 mm - 3 x 0,75 mm ²	940401
L3000 mm - 5 x 0,75 mm ²	940501
L6000 mm - 3 x 0,75 mm ²	940402
L6000 mm - 5 x 0,75 mm ²	940507

Caixa de alimentação quadrada

Saliente T25 Q100  45  100	978610▲
Encastrar T7 Q90  Ø70 35  90	971400▲

Cor ▲
 Branco W
 Preto B



Detalhes do produto

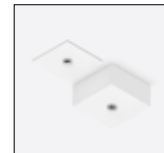

Caixas de alimentação

ELI /C



Características do produto

Corpo

Alumínio

Acabamento

Revestido a epóxi-poliéster

Sistema ótico

PB - Refletor brilhante

Fonte de luz

LED, RG1, CRI>90, MacAdam Step ≤3

Vida útil LED

50.000h @ L90, B10, Ta 25°C

Fonte de alimentação

Driver LED 220-240V-50/60Hz incluído



230V/50Hz



IP 20

650°C

01. Seleccionar versão



ELI / C

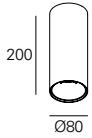

PB - Refletor brilhante - 35°

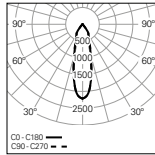

UGR	W	lm output	lm/W	CÓDIGO*
≤19	6	706	118	90347L200▼▲0◆35
≤19	9	1161	129	90596L200▼▲0◆35

PB - Refletor brilhante - 60°

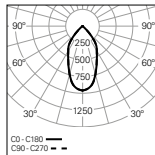

UGR	W	lm output	lm/W	CÓDIGO*
≤22	6	706	118	90347L200▼▲0◆60
≤22	9	1161	129	90596L200▼▲0◆60

*Substitua os símbolos para completar o código

Fonte de alimentação ▼
 HF E
 DALI H

Cor ▲
 Branco W
 Preto B

Temp. de Cor ◆
 3000K 3
 4000K 0

ELI Sq /C



Características do produto

Corpo

Alumínio

Acabamento

Revestido a epóxi-poliéster

Sistema ótico

PB - Refletor brilhante

Fonte de luz

LED, RG1, CRI>90, MacAdam Step ≤3

Vida útil LED

50.000h @ L90, B10, Ta 25°C

Fonte de alimentação

Driver LED 220-240V-50/60Hz incluído



230V/50Hz



IP 20

650°C

01. Seleccionar versão



ELI Sq /C

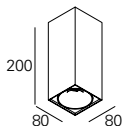

PB - Refletor brilhante - 35°

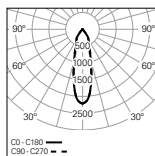

UGR	W	lm output	lm/W	CÓDIGO*
≤19	6	706	118	90672L200▼▲0◆35
≤19	9	1161	129	90598L200▼▲0◆35

PB - Refletor brilhante - 60°

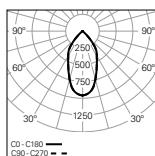

UGR	W	lm output	lm/W	CÓDIGO*
≤22	6	706	118	90672L200▼▲0◆60
≤22	9	1161	129	90598L200▼▲0◆60

*Substitua os símbolos para completar o código

Fonte de alimentação ▼
 HF E
 DALI H

Cor ▲
 □ Branco W
 ■ Preto B

Temp. de Cor ◆
 3000K 3
 4000K 0





ELI /W



Características do produto

Corpo

Alumínio

Acabamento

Revestido a epóxi-poliéster

Sistema ótico

PB - Refletor brilhante

Fonte de luz

LED, RG1, CRI>90, MacAdam Step ≤3

Vida útil LED

50.000h @ L90, B10, Ta 25°C

Fonte de alimentação

Driver LED 220-240V-50/60Hz incluído



230V/50Hz



IP 20

650°C

01. Seleccionar versão



ELI /W

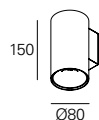

PB - Refletor brilhante - 35°

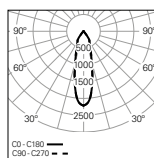

W
6
9

lm
output
706
1161

lm/W
118
129

CÓDIGO*

90670L150▼▲0◆35
90646L150▼▲0◆35

CO - C180 —
C90 - C270 - -

*Substitua os símbolos para completar o código

Fonte de alimentação ▼
HF E
DALI H

Cor ▲
□ Branco W
■ Preto B

PB - Refletor brilhante - 60°

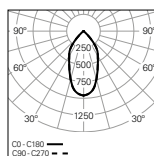

W
6
9

lm
output
706
1161

lm/W
118
129

CÓDIGO*

90670L150▼▲0◆60
90646L150▼▲0◆60

CO - C180 —
C90 - C270 - -

Temp. de Cor ◆
3000K 3
4000K 0

ELI Sq /W



Características do produto

Corpo

Alumínio

Acabamento

Revestido a epóxi-poliéster

Sistema ótico

PB - Refletor brilhante

Fonte de luz

LED, RG1, CRI>90, MacAdam Step ≤3

Vida útil LED

50.000h @ L90, B10, Ta 25°C

Fonte de alimentação

Driver LED 220-240V-50/60Hz incluído



230V/50Hz



IP 20

650°C

01. Selecionar versão



ELI Sq /W

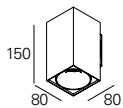

PB - Refletor brilhante - 35°

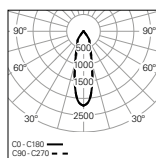

W
6
9

lm output
706
1161

lm/W
118
129

CÓDIGO*

90675L150▼▲0◆35
90648L150▼▲0◆35

*Substitua os símbolos para completar o código

Fonte de alimentação ▼
HF E
DALI H

Cor ▲
□ Branco W
■ Preto B

PB - Refletor brilhante - 60°

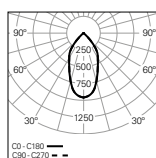

W
6
9

lm output
706
1161

lm/W
118
129

CÓDIGO*

90675L150▼▲0◆60
90648L150▼▲0◆60

Temp. de Cor ◆
3000K 3
4000K 0

ELI /W D/I



Características do produto

Corpo

Alumínio

Acabamento

Revestido a epóxi-poliéster

Sistema ótico

PB - Refletor brilhante

Fonte de luz

LED, RG1, CRI>90, MacAdam Step ≤3

Vida útil LED

50.000h @ L90, B10, Ta 25°C

Fonte de alimentação

Driver LED 220-240V-50/60Hz incluído



230V/50Hz



IP 20

650°C

01. Seleccionar versão



ELI /W D/I

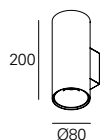

PB - Refletor brilhante - 35°

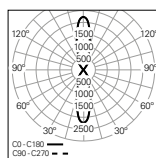

W
10

lm
output
1258

lm/W
126

CÓDIGO*
90651L200▼▲0◆35

PB - Refletor brilhante - 60°

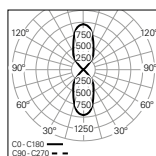

W
10

lm
output
1244

lm/W
124

CÓDIGO*
90651L200▼▲0◆60

*Substitua os símbolos para completar o código

Fonte de alimentação ▼
HF E
DALI H

Cor ▲
□ Branco W
■ Preto B

Temp. de Cor ◆
3000K 3
4000K 0

ELI Sq /W D/I



Características do produto

Corpo

Alumínio

Acabamento

Revestido a epóxi-poliéster

Sistema ótico

PB - Refletor brilhante

Fonte de luz

LED, RG1, CRI>90, MacAdam Step ≤3

Vida útil LED

50.000h @ L90, B10, Ta 25°C

Fonte de alimentação

Driver LED 220-240V-50/60Hz incluído



230V/50Hz



IP 20

650°C

01. Selecionar versão



ELI Sq /W D/I

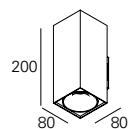

PB - Refletor brilhante - 35°

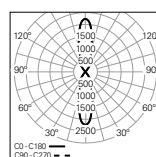

W
10

lm output
1258

lm/W
126

CÓDIGO*
90653L200▼▲0◆35

PB - Refletor brilhante - 60°

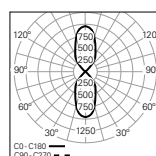

W
10

lm output
1244

lm/W
124

CÓDIGO*
90653L200▼▲0◆60

*Substitua os símbolos para completar o código

Fonte de alimentação ▼
HF E
DALI H

Cor ▲
□ Branco W
■ Preto B

Temp. de Cor ◆
3000K 3
4000K 0



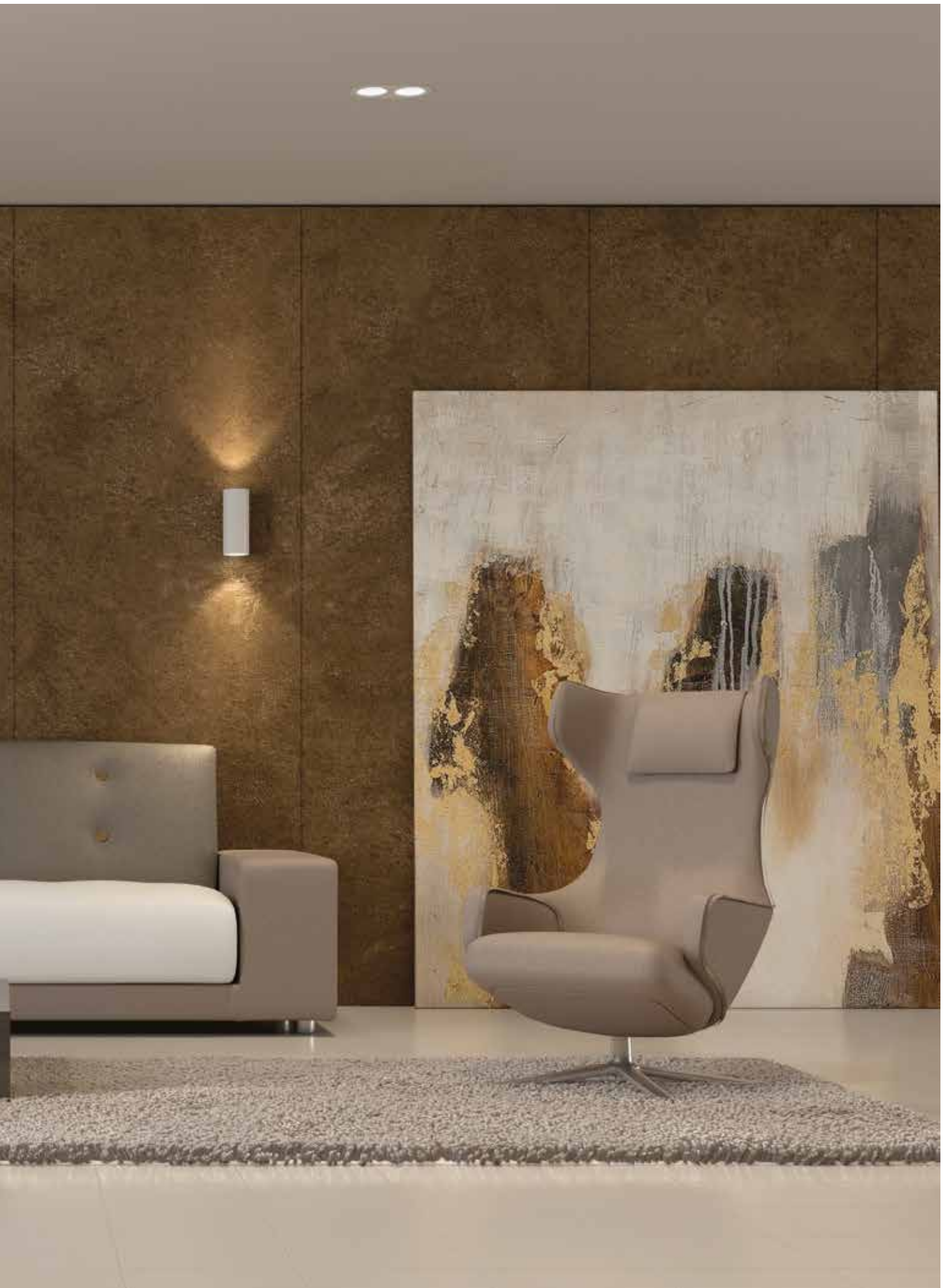



Iluminação
arquitetural

FOCUS 2



FOCUS 2
360



FOCUS 2



Características do produto

Corpo

Alumínio

Acabamento

Revestido a epóxi-poliéster

Sistema ótico

SPOT
FLOOD
WIDE FLOOD
EXTRA WIDE

Fonte de luz

LED, RG1, CRI>80, MacAdam Step ≤3

Vida útil LED

50.000h @ L80, B10, Ta 25°C

Fonte de alimentação

Driver LED 220-240V-50/60Hz
com adaptador de calha incluído

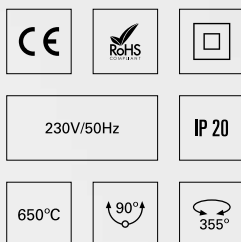

01. Selecionar versão

FOCUS 2

HF

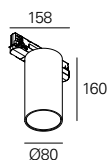

DALI

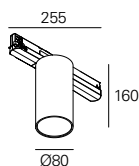

SPOT - Ângulo de abertura - 15°

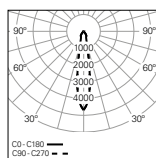

UGR	W	lm output	lm/W	CÓDIGO*
≤19	9	1082	120	90768L080▼▲◆15
≤22	15	2071	138	90791L080▼▲◆15
≤22	23	3068	133	90763L080▼▲◆15

CO - C180
CB - C270

FLOOD - Ângulo de abertura - 25°

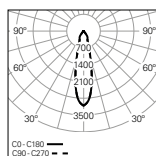

UGR	W	lm output	lm/W	CÓDIGO*
≤19	9	1057	117	90768L080▼▲◆25
≤22	15	2047	136	90791L080▼▲◆25
≤22	23	3033	132	90763L080▼▲◆25

CO - C180
CB - C270

WIDE FLOOD - Ângulo de abertura - 40°

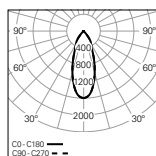

UGR	W	lm output	lm/W	CÓDIGO*
≤19	9	1045	116	90768L080▼▲◆40
≤22	15	2023	135	90791L080▼▲◆40
≤22	23	3033	132	90763L080▼▲◆40

CO - C180
CB - C270

EXTRA WIDE - Ângulo de abertura - 60°

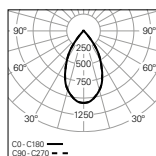

UGR	W	lm output	lm/W	CÓDIGO*
≤22	9	1045	116	90768L080▼▲◆60
≤22	15	1999	133	90791L080▼▲◆60
≤25	23	2998	130	90763L080▼▲◆60

CO - C180
CB - C270



*Substitua os símbolos para completar o código

Fonte de alimentação
HF E
DALI H

Cor
□ Branco W
■ Preto B

Temp. de Cor
3000K CRI>80 3
4000K CRI>80 0
3000K CRI>90 B
4000K CRI>90 A

02. Selecionar opções

OPÇÕES

Sistema de calha

- Ver página 800.



Detalhes do produto



Acabamento em branco



Sistema ótico



Adaptador



VEGA



VEGA /E
366



VEGA Sq /E
368



VEGA
372



VEGA Sq
374



VEGA IP /E
378



VEGA Sq IP /E
380



VEGA IP
382



Tipos de aplicação

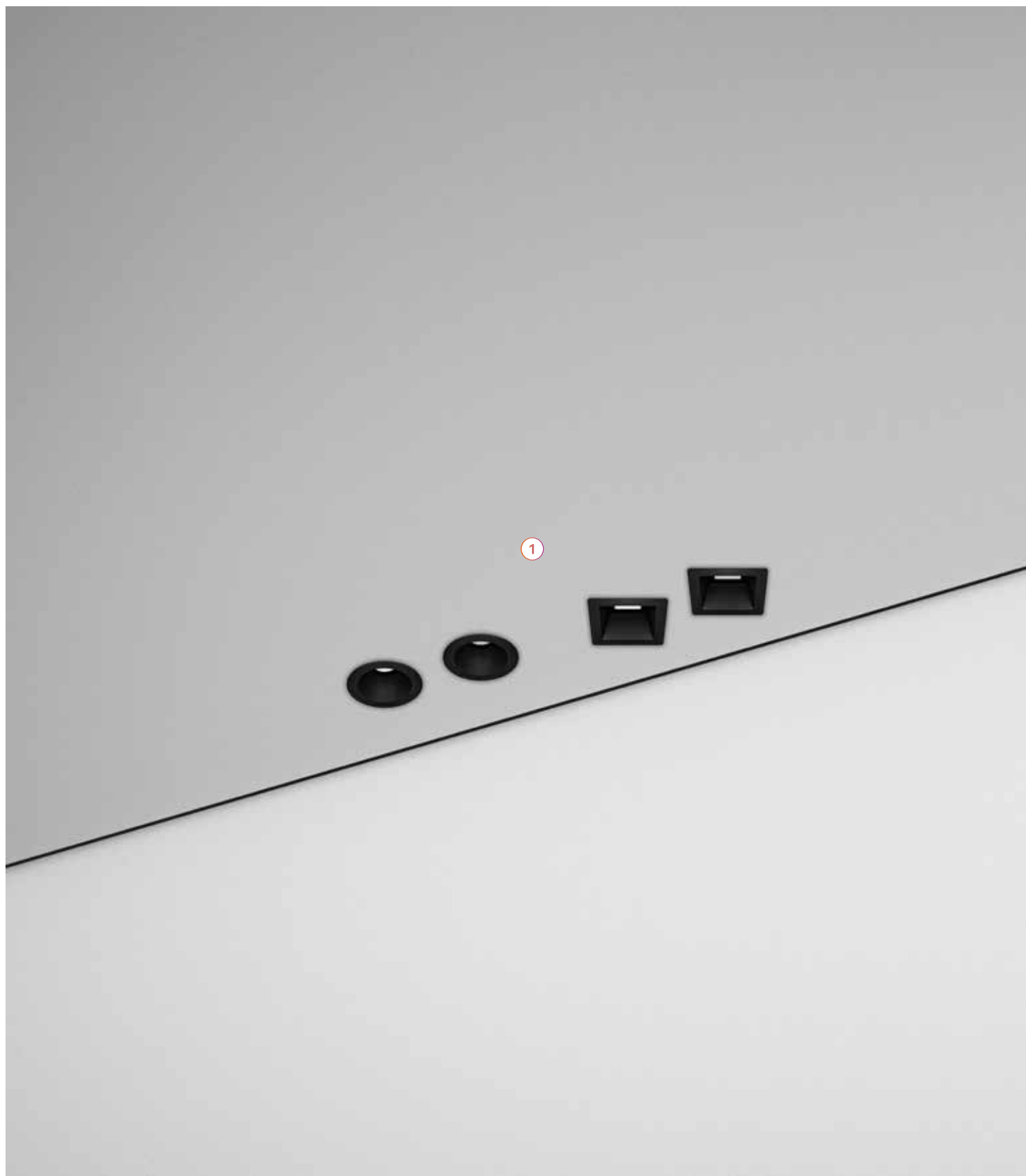

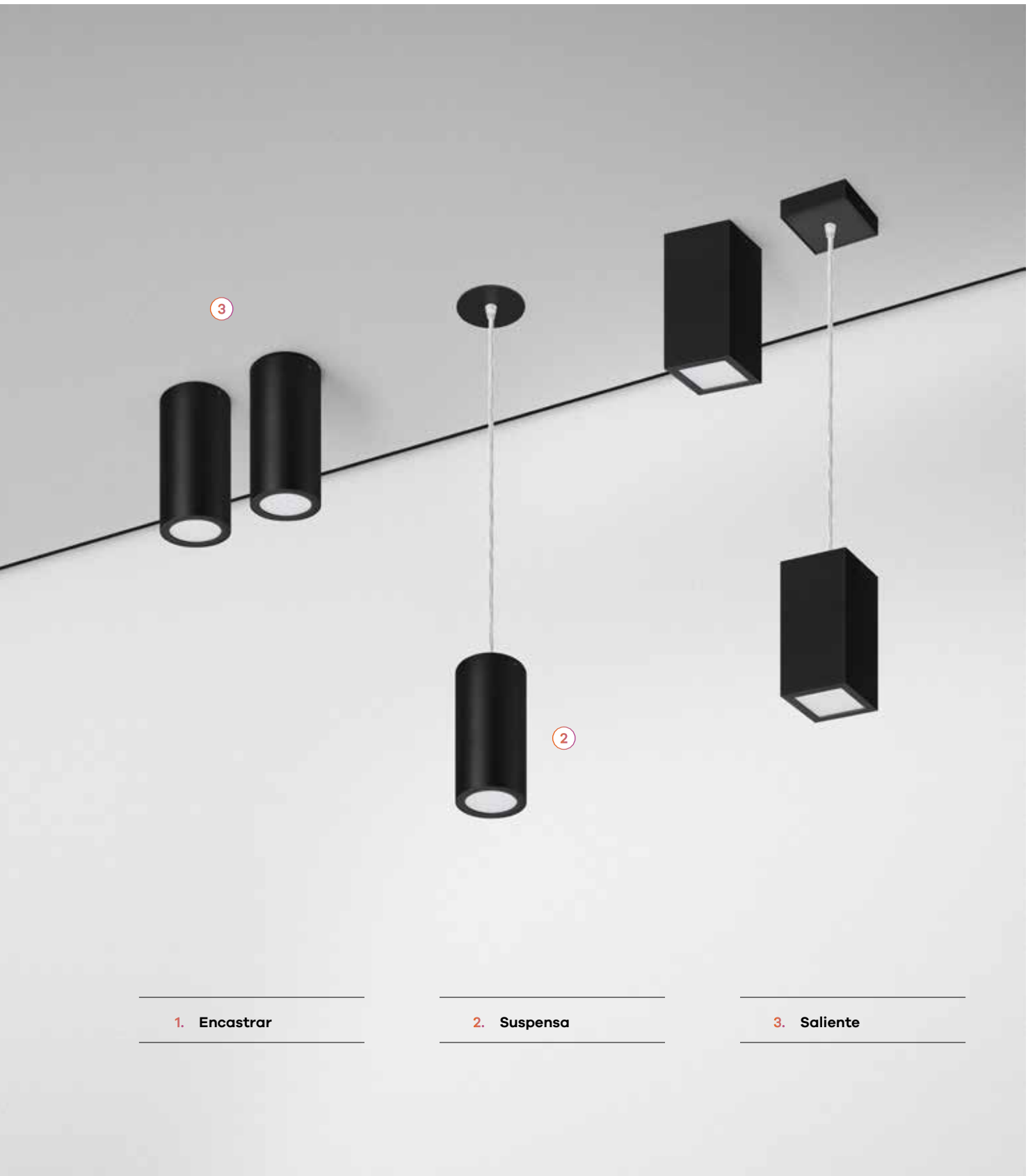

1. Encastrar

2. Suspensa

3. Saliente

VEGA /E



Características do produto

Corpo

ABS injetado e dissipador em alumínio

Acabamento

Revestido a epóxi-poliéster

Sistema ótico

PRISM+ - Difusor microprismático
LIGHT+ - Difusor opalino

Fonte de luz

LED, CRI>90, MacAdam Step ≤3

Vida útil LED

50.000h @ L90, B10, Ta 25°C

Fonte de alimentação

Não incluída

Espessura do teto

Para tetos entre 1-25 mm



01. Selecionar versão

VEGA / E

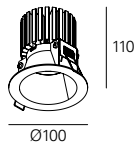

PRISM+ - Difusor microprismático

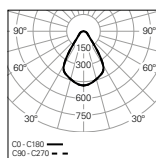

UGR	W	lm output	lm/W	mA	Ø	CÓDIGO*
≤19	7	701	100	200	Ø85	90441L0080▲0◆00
≤22	8	856	107	250	Ø85	90441L0110▲0◆00
≤22	12	1152	96	350	Ø85	90441L0150▲0◆00

LIGHT+ - Difusor opalino

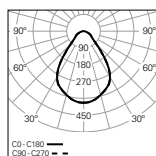

UGR	W	lm output	lm/W	mA	Ø	CÓDIGO*
≤22	7	649	93	200	Ø85	90430L0080▲0◆00
≤22	8	791	99	250	Ø85	90430L0110▲0◆00
≤22	12	1082	90	350	Ø85	90430L0150▲0◆00

VEGA / E

• Para completar o produto é necessário encomendar fonte de alimentação em separado.



*Substitua os símbolos para completar o código

Cor ▲
 Branco W
 Preto B

Temp. de Cor ◆
 3000K 3
 4000K 0

02. Selecionar opções

OPÇÕES Código

Fonte de alimentação HF

Driver 8,4W 10-42V 200mA HF	900001E
Driver 10,5W 10-42V 250mA HF	900002E
Driver 14,7W 10-42V 350mA HF	900004E

Fonte de alimentação DALI

Driver 10,4W 09-52V 200mA DALI+ PUSH	900101H
Driver 13W 09-52V 250mA DALI+ PUSH	900102H
Driver 18,2W 09-52V 350mA DALI+ PUSH	900104H

Cabo de segurança em aço

L 1500 mm	955010
-----------	--------



Detalhes do produto



Acabamento em branco

VEGA Sq /E



Características do produto

Corpo

ABS injetado e dissipador em alumínio

Acabamento

Revestido a epóxi-poliéster

Sistema ótico

PRISM+ - Difusor microprismático
LIGHT+ - Difusor opalino

Fonte de luz

LED, CRI>90, MacAdam Step ≤3

Vida útil LED

50.000h @ L90, B10, Ta 25°C

Fonte de alimentação

Não incluída

Espessura do teto

Para tetos entre 1-25 mm



01. Selecionar versão

VEGA Sq /E

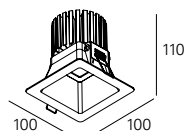

PRISM+ - Difusor microprismático

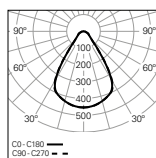

UGR	W	lm output	lm/W	mA	Φ	CÓDIGO*
≤19	7	712	102	200	85x85	90442L0080▲0◆00
≤19	8	869	109	250	85x85	90442L0110▲0◆00
≤22	12	1170	98	350	85x85	90442L0150▲0◆00

LIGHT+ - Difusor opalino

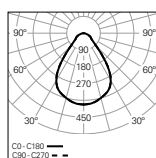

UGR	W	lm output	lm/W	mA	Φ	CÓDIGO*
≤19	7	701	100	200	85x85	90437L0080▲0◆00
≤22	8	856	107	250	85x85	90437L0110▲0◆00
≤22	12	1152	96	350	85x85	90437L0150▲0◆00

VEGA Sq /E

• Para completar o produto é necessário encomendar fonte de alimentação em separado.



*Substitua os símbolos para completar o código

Cor ▲
 Branco W
 Preto B

Temp. de Cor ◆
 3000K 3
 4000K 0

02. Selecionar opções

OPÇÕES

Fonte de alimentação HF

Descrição	Código
Driver 8,4W 10-42V 200mA HF	900001E
Driver 10,5W 10-42V 250mA HF	900002E
Driver 14,7W 10-42V 350mA HF	900004E

Fonte de alimentação DALI

Descrição	Código
Driver 10,4W 09-52V 200mA DALI+ PUSH	900101H
Driver 13W 09-52V 250mA DALI+ PUSH	900102H
Driver 18,2W 09-52V 350mA DALI+ PUSH	900104H

Cabo de segurança em aço

Descrição	Código
L 1500 mm	955010



Detalhes do produto



Acabamento em branco





VEGA



Características do produto

Corpo

Alumínio

Acabamento

Revestido a epóxi-poliéster

Sistema ótico

PRISM+ - Difusor microprismático
LIGHT+ - Difusor opalino

Fonte de luz

LED, CRI>90, MacAdam Step ≤3

Vida útil LED

50.000h @ L90, B10, Ta 25°C

Fonte de alimentação

Driver LED 220-240V-50/60Hz incluído



230V/50Hz



IP 40

650°C

01. Selecionar versão



VEGA

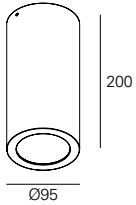

PRISM+ - Difusor microprismático

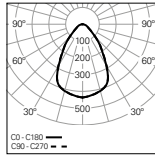

UGR	W	lm output	lm/W	CÓDIGO*
≤19	8	681	85	90445L008▼▲0◆00
≤19	9	843	94	90445L011▼▲0◆00
≤22	14	1152	82	90445L015▼▲0◆00

LIGHT+ - Difusor opalino

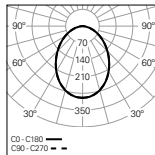

UGR	W	lm output	lm/W	CÓDIGO*
≤22	8	691	86	90443L008▼▲0◆00
≤22	9	856	95	90443L011▼▲0◆00
≤25	14	1152	82	90443L015▼▲0◆00

*Substitua os símbolos para completar o código

Fonte de alimentação ▼
 HF E
 DALI H

Cor ▲
 □ Branco W
 ■ Preto B

Temp. de Cor ◆
 3000K 3
 4000K 0

VEGA

• Para versão suspenso é necessário encomendar caixa de alimentação em separado.

02. Selecionar caixa de alimentação



Encastrar

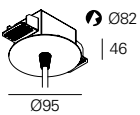

HF

Ø95 CÓDIGO*
 912620▲

DALI

Ø95 CÓDIGO*
 912630▲

Saliente

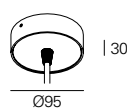

HF

Ø95 CÓDIGO*
 912600▲

DALI

Ø95 CÓDIGO*
 912610▲

*Substitua os símbolos para completar o código

Cor ▲
 □ Branco W
 ■ Preto B

CAIXA DE ALIMENTAÇÃO

• Cabo de alimentação transparente com L1500 mm incluído.

VEGA Sq



Características do produto

Corpo

Alumínio

Acabamento

Revestido a epóxi-poliéster

Sistema ótico

PRISM+ - Difusor microprismático
LIGHT+ - Difusor opalino

Fonte de luz

LED, CRI>90, MacAdam Step ≤3

Vida útil LED

50.000h @ L90, B10, Ta 25°C

Fonte de alimentação

Driver LED 220-240V-50/60Hz incluído



230V/50Hz



IP 40

650°C

01. Selecionar versão



VEGA Sq

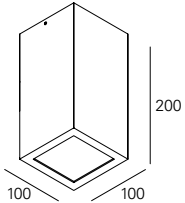

PRISM+ - Difusor microprismático

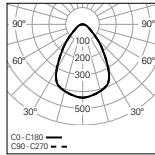

UGR	W	lm output	lm/W	CÓDIGO*
≤19	8	743	93	90446L008▼▲0◆00
≤19	9	908	101	90446L011▼▲0◆00
≤22	14	1241	89	90446L015▼▲0◆00

LIGHT+ - Difusor opalino

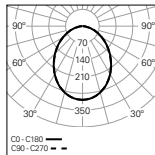

UGR	W	lm output	lm/W	CÓDIGO*
≤22	8	743	93	90444L008▼▲0◆00
≤22	9	921	102	90444L011▼▲0◆00
≤25	14	1259	90	90444L015▼▲0◆00

*Substitua os símbolos para completar o código

Fonte de alimentação ▼
 HF E
 DALI H

Cor ▲
 □ Branco W
 ■ Preto B

Temp. de Cor ◆
 3000K 3
 4000K 0

VEGA Sq

• Para versão suspensa é necessário encomendar caixa de alimentação em separado.

02. Selecionar caixa de alimentação



Encastrar

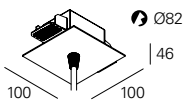

HF

100x100 CÓDIGO*
912720▲

DALI

100x100 CÓDIGO*
912730▲

Saliente

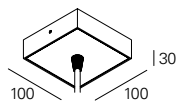

HF

100x100 CÓDIGO*
912700▲

DALI

100x100 CÓDIGO*
912710▲

*Substitua os símbolos para completar o código

Cor ▲
 □ Branco W
 ■ Preto B

CAIXA DE ALIMENTAÇÃO

• Cabo de alimentação transparente com L1500 mm incluído.

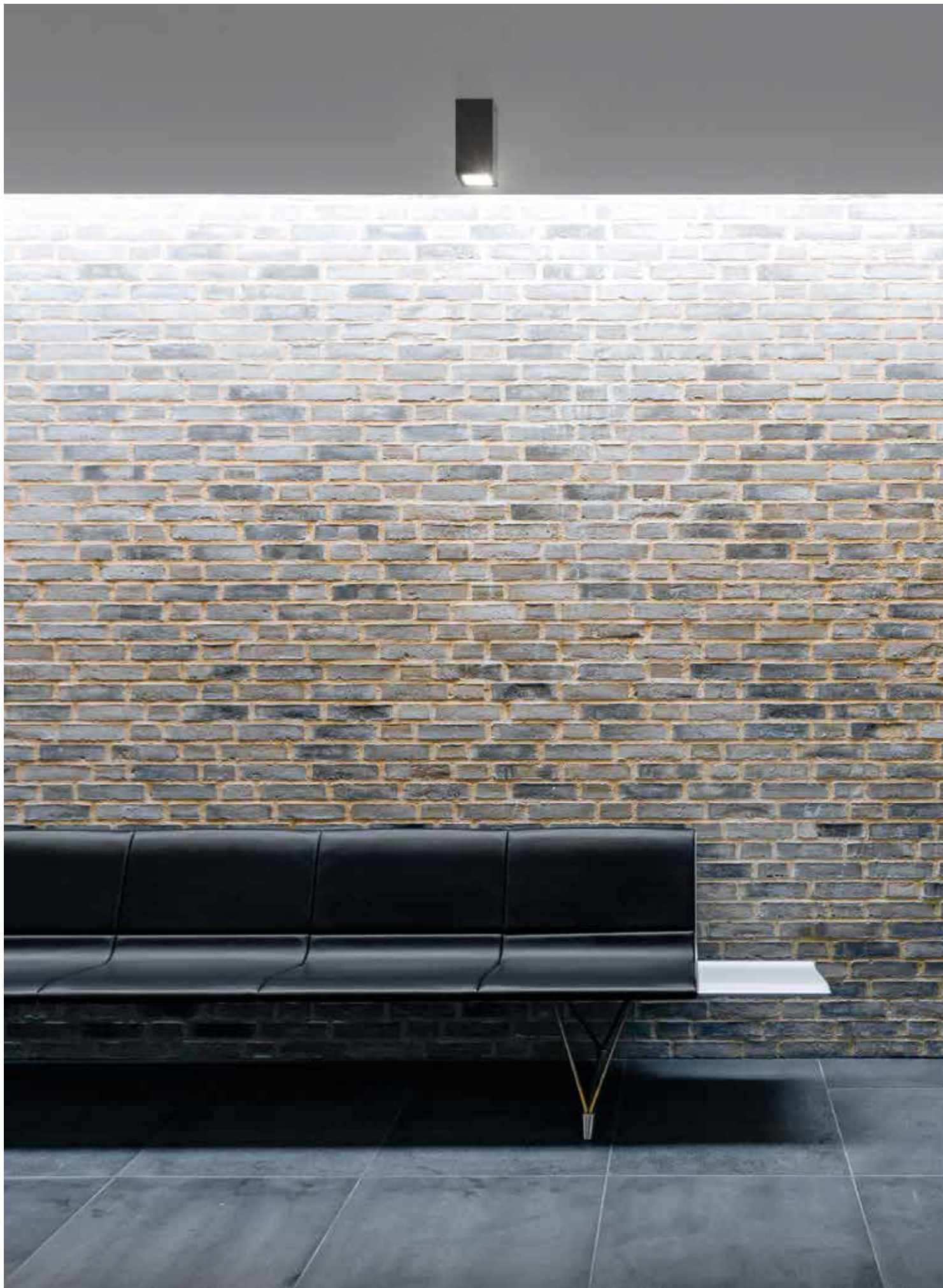

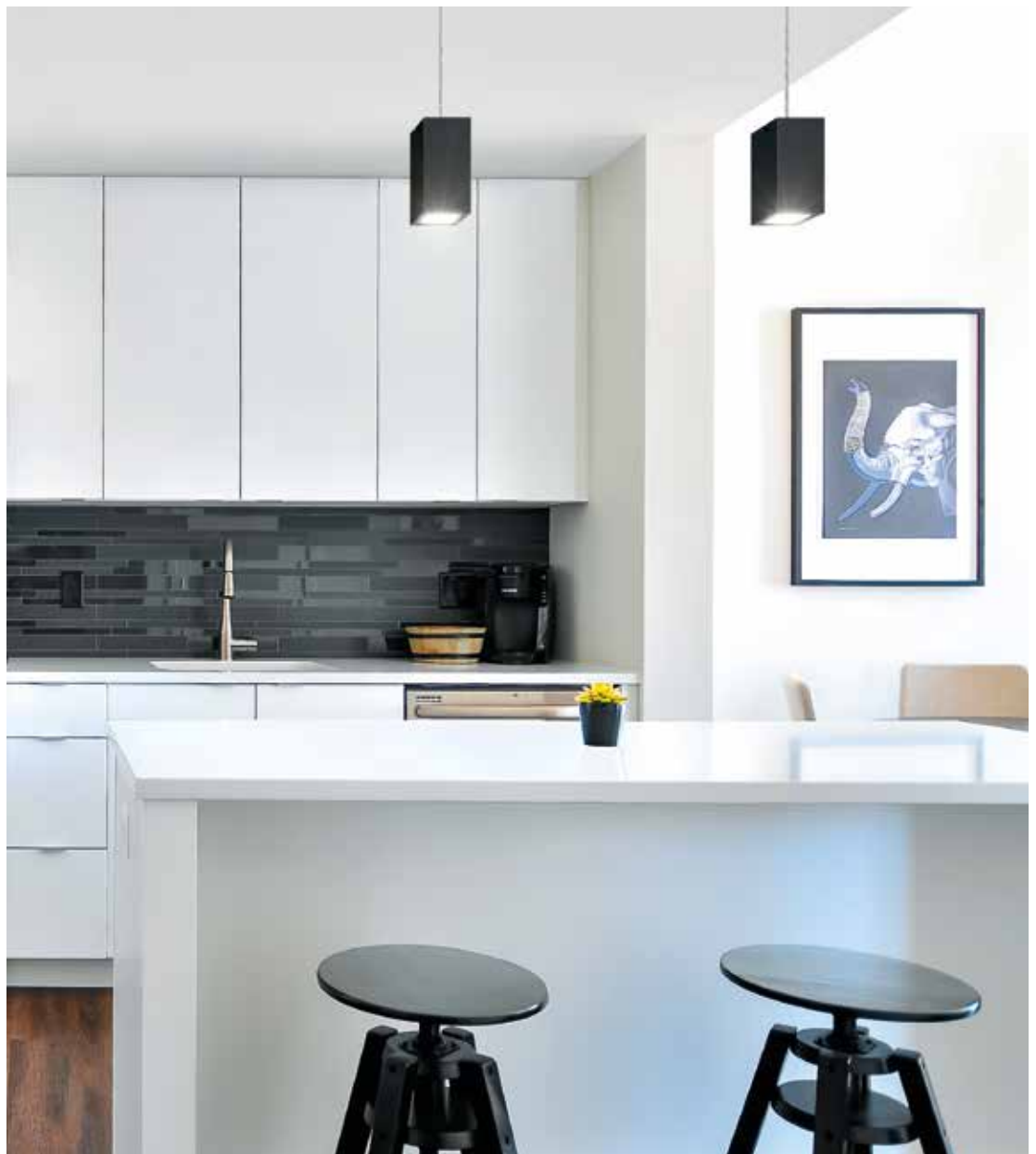

VEGA IP /E



Características do produto

Corpo

ABS injetado e dissipador em alumínio



Acabamento

Revestido a epóxi-poliéster



Sistema ótico

LIGHT+ - Difusor opalino



Fonte de luz

LED, CRI>90, MacAdam Step ≤3

Vida útil LED

50.000h @ L90, B10, Ta 25°C



Fonte de alimentação

Não incluída

Espessura do teto

Para tetos entre 1-25 mm

01. Selecionar versão

VEGA IP / E

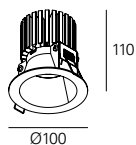

LIGHT+ - Difusor opalino

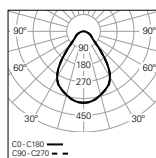

W	lm output	lm/W	mA	Ø	CÓDIGO*
7	649	93	200	Ø85	90575L0080▲0◆00
8	791	99	250	Ø85	90575L0110▲0◆00
12	1082	90	350	Ø85	90575L0150▲0◆00



*Substitua os símbolos para completar o código

Cor	W
□ Branco	W
■ Preto	B

Temp. de Cor	◆
3000K	3
4000K	0

VEGA IP / E

- Para completar o produto é necessário encomendar fonte de alimentação em separado.

02. Selecionar opções

OPÇÕES

Fonte de alimentação HF	Código
Driver 8,4W 10-42V 200mA HF	900001E
Driver 10,5W 10-42V 250mA HF	900002E
Driver 14,7W 10-42V 350mA HF	900004E

Fonte de alimentação DALI	Código
Driver 10,4W 09-52V 200mA DALI+ PUSH	900101H
Driver 13W 09-52V 250mA DALI+ PUSH	900102H
Driver 18,2W 09-52V 350mA DALI+ PUSH	900104H

Cabo de segurança em aço	Código
L 1500 mm	955010



Detalhes do produto



Acabamento em branco

VEGA Sq IP /E



Características do produto

Corpo

ABS injetado e dissipador em alumínio

Acabamento

Revestido a epóxi-poliéster

Sistema ótico

LIGHT+ - Difusor opalino

Fonte de luz

LED, CRI>90, MacAdam Step ≤3

Vida útil LED

50.000h @ L90, B10, Ta 25°C

Fonte de alimentação

Não incluída

Espessura do teto

Para tetos entre 1-25 mm



01. Selecionar versão

VEGA Sq IP /E

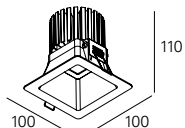

LIGHT+ - Difusor opalino

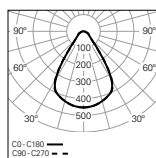

W	lm output	lm/W	mA	Φ	CÓDIGO*
7	701	100	200	85x85	90569L0080▲0♦00
8	856	107	250	85x85	90569L0110▲0♦00
12	1152	96	350	85x85	90569L0150▲0♦00



*Substitua os símbolos para completar o código

Cor	▲
□ Branco	W
■ Preto	B

Temp. de Cor	♦
3000K	3
4000K	0

VEGA IP Sq /E

• Para completar o produto é necessário encomendar fonte de alimentação em separado.

02. Selecionar opções

OPÇÕES

Fonte de alimentação HF	Código
Driver 8,4W 10-42V 200mA HF	900001E
Driver 10,5W 10-42V 250mA HF	900002E
Driver 14,7W 10-42V 350mA HF	900004E

Fonte de alimentação DALI	Código
Driver 10,4W 09-52V 200mA DALI+ PUSH	900101H
Driver 13W 09-52V 250mA DALI+ PUSH	900102H
Driver 18,2W 09-52V 350mA DALI+ PUSH	900104H

Cabo de segurança em aço	Código
L 1500 mm	955010



Detalhes do produto



Acabamento em branco

VEGA IP



Características do produto

Corpo

Alumínio

**Acabamento**

Revestido a epóxi-poliéster

230V/50Hz

Sistema ótico

LIGHT+ - Difusor opalino

**Fonte de luz**

LED, CRI>90, MacAdam Step ≤3

Vida útil LED

50.000h @ L90, B10, Ta 25°C

**Fonte de alimentação**

Driver LED 220-240V-50/60Hz incluído

01. Seleccionar versão

VEGA IP

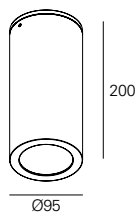

LIGHT+ - Difusor opalino

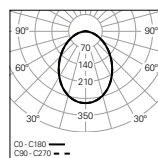

W
8
9
14

lm
output
691
856
1152

lm/W
86
95
82

CÓDIGO*

90447L008▼▲◆00
90447L011▼▲◆00
90447L015▼▲◆00



*Substitua os símbolos para completar o código

Fonte de alimentação ▼
HF E
DALI H

Cor ▲
□ Branco W
■ Preto B

Temp. de Cor ◆
3000K 3
4000K 0



Detalhes do produto



Acabamento em branco







HOLI



HOLI Sq /T Mini
388



HOLI Sq /T
390



HOLI Sq /T Max
392



HOLI Sq Mini
396



HOLI Sq
398

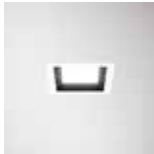

HOLI Sq Max
400



HOLI Sq /AS Max
404



HOLI Sq /C Mini
406



HOLI Sq /C
408



HOLI Sq /C Max
410



HOLI Sq /T Mini



Características do produto

Corpo

Chapa de aço

Acabamento

Revestido a epóxi-poliéster

Sistema de fixação

Pré-aro trimless

Sistema ótico

PRISM+ - Difusor microprismático
LIGHT+ - Difusor opalino

Fonte de luz

LED, RG1, CRI>80, MacAdam Step ≤3

Vida útil LED

60.000h @ L70, B10, Ta 25°C

Fonte de alimentação

Não incluída



230V/50Hz



IP 40

650°C



01. Selecionar versão

HOLI Sq /T Mini

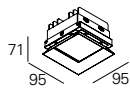

PRISM+ - Difusor microprismático

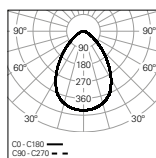

W	Im output	lm/W	mA	Φ	CÓDIGO*
7	759	115	200	101x101	90222L1070▲0♦00

LIGHT+ - Difusor opalino

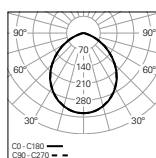

W	Im output	lm/W	mA	Φ	CÓDIGO*
7	837	120	200	101x101	90267L1070▲0♦00



*Substitua os símbolos para completar o código

Cor	▲
<input type="checkbox"/> Branco	W
<input checked="" type="checkbox"/> Preto	B

Temp. de Cor	♦
3000K	3
4000K	0

HOLI Sq /T Mini

• Para completar o produto é necessário encomendar fonte de alimentação e pré-aro em separado.

02. Selecionar opções

OPÇÕES	Código
Fonte de alimentação HF Driver 8,4W 10-42V 200mA HF	900001E
Fonte de alimentação DALI Driver 10,4W 09-52V 200mA DALI+ PUSH	900101H
Pré-aro Branco	971500
	
Cabo de segurança em aço L1500 mm	955000



Detalhes do produto



Acabamento em branco



Acabamento em preto

HOLI Sq /T



Características do produto

Corpo

Chapa de aço



Acabamento

Revestido a epóxi-poliéster

230V/50Hz

Sistema de fixação

Pré-aro trimless



Sistema ótico

PRISM+ - Difusor microprismático
LIGHT+ - Difusor opalino

Fonte de luz

LED, RG1, CRI>80, MacAdam Step ≤3



Vida útil LED

60.000h @ L70, B10, Ta 25°C

Fonte de alimentação

Não incluída

01. Selecionar versão

HOLI Sq /T

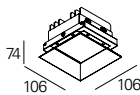

PRISM+ - Difusor microprismático

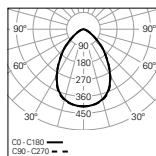

W	lm output	lm/W	mA	□	CÓDIGO*
7	748	107	200	114x114	90223L1060▲0♦00
8	927	116	250	114x114	90223L1100▲0♦00

LIGHT+ - Difusor opalino

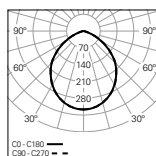

W	lm output	lm/W	mA	□	CÓDIGO*
7	826	118	200	114x114	90272L1060▲0♦00
8	1023	128	250	114x114	90272L1100▲0♦00



*Substitua os símbolos para completar o código

Cor ▲
 Branco W
 Preto B

Temp. de Cor ♦
 3000K 3
 4000K 0

HOLI Sq /T

• Para completar o produto é necessário encomendar fonte de alimentação e pré-aro em separado.

02. Selecionar opções

OPÇÕES Código

Fonte de alimentação HF

Driver 8,4W 10-42V 200mA HF	900001E
Driver 10,5W 10-42V 250mA HF	900002E

Fonte de alimentação DALI

Driver 10,4W 09-52V 200mA DALI+ PUSH	900101H
Driver 13W 09-52V 250mA DALI+ PUSH	900102H

Pré-aro

Branco 971501

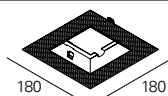

Cabo de segurança em aço

L1500 mm 955000



Detalhes do produto



Acabamento em branco



Acabamento em preto

HOLI Sq /T Max



Características do produto

Corpo

Chapa de aço



Acabamento

Revestido a epóxi-poliéster

230V/50Hz

Sistema de fixação

Pré-aro trimless



Sistema ótico

PRISM+ - Difusor microprismático
LIGHT+ - Difusor opalino

Fonte de luz

LED, RG1, CRI>80, MacAdam Step ≤3



Vida útil LED

60.000h @ L70, B10, Ta 25°C

Fonte de alimentação

Não incluída

01. Selecionar versão

HOLI Sq /T Max

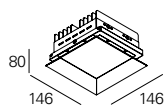

PRISM+ - Difusor microprismático

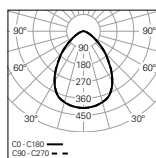

W	lm output	lm/W	mA	█	CÓDIGO*
8	1010	126	250	155x155	90224L1100▲0◆00
12	1363	114	350	155x155	90224L1130▲0◆00
18	1900	106	500	155x155	90224L1170▲0◆00

LIGHT+ - Difusor opalino

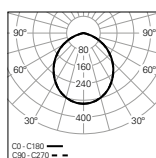

W	lm output	lm/W	mA	█	CÓDIGO*
8	1120	140	250	155x155	90287L1100▲0◆00
12	1533	128	350	155x155	90287L1130▲0◆00
18	2082	116	500	155x155	90287L1170▲0◆00



*Substitua os símbolos para completar o código

Cor ▲
 Branco W
 Preto B

Temp. de Cor ◆
 3000K 3
 4000K 0

HOLI Sq /T Max

• Para completar o produto é necessário encomendar fonte de alimentação e pré-aro em separado.

02. Selecionar opções

OPÇÕES

Fonte de alimentação HF

Driver 10,5W 10-42V 250mA HF	900002E
Driver 14,7W 10-42V 350mA HF	900004E
Driver 21W 10-42V 500mA HF	900007E

Fonte de alimentação DALI

Driver 13W 09-52V 250mA DALI+ PUSH	900102H
Driver 18,2W 09-52V 350mA DALI+ PUSH	900104H
Driver 26W 09-52V 500mA DALI+ PUSH	900107H

Pré-aro

Branco 971502

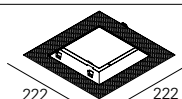

Cabo de segurança em aço

L1500 mm 955000



Detalhes do produto



Acabamento em branco



Acabamento em preto





HOLI Sq Mini



Características do produto

Corpo

Chapa de aço

Acabamento

Revestido a epóxi-poliéster

Sistema ótico

PRISM+ - Difusor microprismático
LIGHT+ - Difusor opalino

Fonte de luz

LED, RG1, CRI>80, MacAdam Step ≤3

Vida útil LED

60.000h @ L70, B10, Ta 25°C

Fonte de alimentação

Não incluída

Espessura do teto

Para tetos entre 1-20 mm



230V/50Hz



650°C



01. Selecionar versão

HOLI Sq Mini

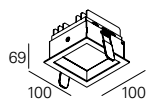

PRISM+ - Difusor microprismático

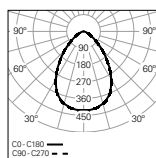

W	Im output	lm/W	mA	IP	CÓDIGO*
7	759	115	200	97x97	90258L1070▲0◆▲0

LIGHT+ - Difusor opalino

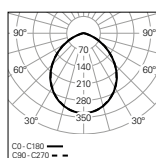

W	Im output	lm/W	mA	IP	CÓDIGO*
7	837	120	200	97x97	90293L1070▲0◆▲0



*Substitua os símbolos para completar o código

Cor	▲/◆
□ Branco	W/W
■ Preto	B/B
▣ Branco/Preto	W/B



Legenda:

- Aro
- Refletor

Temp. de Cor	◆
3000K	3
4000K	0

HOLI Sq Mini

- Para completar o produto é necessário encomendar fonte de alimentação em separado.

02. Selecionar opções

OPÇÕES	Código
Fonte de alimentação HF Driver 8,4W 10-42V 200mA HF	900001E
Fonte de alimentação DALI Driver 10,4W 09-52V 200mA DALI+ PUSH	900101H
Cabo de segurança em aço L1500 mm	955000



Detalhes do produto



Acabamento em branco



Acabamento em preto



Acabamento em branco/preto

HOLI Sq



Características do produto

Corpo

Chapa de aço

Acabamento

Revestido a epóxi-poliéster

Sistema ótico

PRISM+ - Difusor microprismático
LIGHT+ - Difusor opalino

Fonte de luz

LED, RG1, CRI>80, MacAdam Step ≤3

Vida útil LED

60.000h @ L70, B10, Ta 25°C

Fonte de alimentação

Não incluída

Espessura do teto

Para tetos entre 1-20 mm



230V/50Hz



650°C



01. Selecionar versão

HOLI Sq

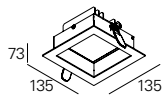

PRISM+ - Difusor microprismático

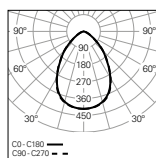

W	lm output	lm/W	mA	□	CÓDIGO*
7	748	107	200	115x115	90259L1060♣0♣♣0
8	927	116	250	115x115	90259L1100♣0♣♣0

LIGHT+ - Difusor opalino

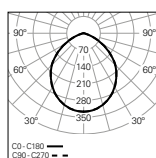

W	lm output	lm/W	mA	□	CÓDIGO*
7	826	118	200	115x115	90294L1060♣0♣♣0
8	1023	128	250	115x115	90294L1100♣0♣♣0



*Substitua os símbolos para completar o código

Cor	♣/♣
□ Branco	W/W
■ Preto	B/B
▣ Branco/Preto	W/B



Legenda:

1. Aro
2. Refletor

Temp. de Cor	♠
3000K	3
4000K	0

HOLI Sq

• Para completar o produto é necessário encomendar fonte de alimentação em separado.

02. Selecionar opções

OPÇÕES	Código
Fonte de alimentação HF	
Driver 8,4W 10-42V 200mA HF	900001E
Driver 10,5W 10-42V 250mA HF	900002E
Fonte de alimentação DALI	
Driver 10,4W 09-52V 200mA DALI+ PUSH	900101H
Driver 13W 09-52V 250mA DALI+ PUSH	900102H
Cabo de segurança em aço	
L1500 mm	955000



Detalhes do produto



Acabamento em branco



Acabamento em preto



Acabamento em branco/preto

HOLI Sq Max



Características do produto

Corpo

Chapa de aço

Acabamento

Revestido a epóxi-poliéster

Sistema ótico

PRISM+ - Difusor microprismático
LIGHT+ - Difusor opalino

Fonte de luz

LED, RG1, CRI>80, MacAdam Step ≤3

Vida útil LED

60.000h @ L70, B10, Ta 25°C

Fonte de alimentação

Não incluída

Espessura do teto

Para tetos entre 1-20 mm



230V/50Hz



650°C



01. Selecionar versão

HOLI Sq Max

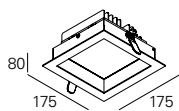

PRISM+ - Difusor microprismático

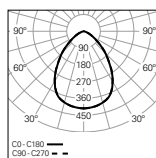

W	lm output	lm/W	mA	Φ	CÓDIGO*
8	1010	126	250	155x155	90264L1100♣♣♣0
12	1363	114	350	155x155	90264L1130♣♣♣0
18	1900	106	500	155x155	90264L1170♣♣♣0

LIGHT+ - Difusor opalino

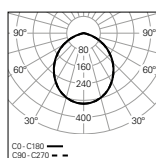

W	lm output	lm/W	mA	Φ	CÓDIGO*
8	1120	140	250	155x155	90295L1100♣♣♣0
12	1533	128	350	155x155	90295L1130♣♣♣0
18	2082	116	500	155x155	90295L1170♣♣♣0



*Substitua os símbolos para completar o código

Cor	♣/♠
□ Branco	W/W
■ Preto	B/B
▣ Branco/Preto	W/B



Legenda:

- Aro
- Refletor

Temp. de Cor	♠
3000K	3
4000K	0

HOLI Sq Max

- Para completar o produto é necessário encomendar fonte de alimentação em separado.

02. Selecionar opções

OPÇÕES	Código
Fonte de alimentação HF	
Driver 10,5W 10-42V 250mA HF	900002E
Driver 14,7W 10-42V 350mA HF	900004E
Driver 21W 10-42V 500mA HF	900007E
Fonte de alimentação DALI	
Driver 13W 09-52V 250mA DALI+ PUSH	900102H
Driver 18,2W 09-52V 350mA DALI+ PUSH	900104H
Driver 26W 09-52V 500mA DALI+ PUSH	900107H
Cabo de segurança em aço	
L1500 mm	955000



Detalhes do produto



Acabamento em branco



Acabamento em preto



Acabamento em branco/preto





HOLI Sq /AS Max



Características do produto

Corpo

Chapa de aço



Acabamento

Revestido a epóxi-poliéster

230V/50Hz

Sistema ótico

LIGHT+ - Difusor opalino



Fonte de luz

LED, RG1, CRI>80, MacAdam Step ≤3

Vida útil LED

60.000h @ L70, B10, Ta 25°C



Fonte de alimentação

Não incluída

Espessura do teto

Para tetos entre 1-20 mm

01. Selecionar versão

HOLI Sq /AS Max

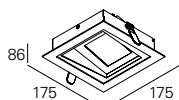

LIGHT+ - Difusor opalino

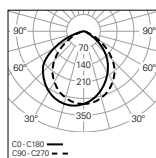

W	lm output	lm/W	mA	□	CÓDIGO*
7	792	113	200	155x155	90393L1060◆◆◆0
12	1344	112	350	155x155	90393L1100◆◆◆0



*Substitua os símbolos para completar o código

Cor	◆◆
□ Branco	W/W
■ Preto	B/B
▣ Branco/Preto	W/B



Legenda:

1. Aro
2. Refletor

HOLI Sq /AS Max

- Para completar o produto é necessário encomendar fonte de alimentação em separado.

Temp. de Cor	◆
3000K	3
4000K	0

02. Selecionar opções

OPÇÕES	Código
Fonte de alimentação HF	
Driver 8,4W 10-42V 200mA HF	900001E
Driver 14,7W 10-42V 350mA HF	900004E
Fonte de alimentação DALI	
Driver 10,4W 09-52V 200mA DALI+ PUSH	900101H
Driver 18,2W 09-52V 350mA DALI+ PUSH	900104H
Cabo de segurança em aço	
L1500 mm	955000



Detalhes do produto



Acabamento em branco



Acabamento em preto



Acabamento em branco/preto

HOLI Sq /C Mini



Características do produto

Corpo

Chapa de aço

Acabamento

Revestido a epóxi-poliéster

Sistema ótico

LIGHT+ - Difusor opalino

Fonte de luz

LED, RG1, CRI>80, MacAdam Step ≤3

Vida útil LED

60.000h @ L70, B10, Ta 25°C

Fonte de alimentação

Driver LED 220-240V-50/60Hz incluído



230V/50Hz



IP 40

650°C

01. Seleccionar versão

HOLI Sq /C Mini

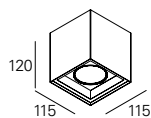

LIGHT+ - Difusor opalino

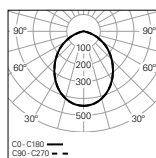

W
8

lm output
930

lm/W
116

CÓDIGO*
90269L006▼♣♠♣♠



*Substitua os símbolos para completar o código

Fonte de alimentação ▼
HF E
DALI H

Cor ♣♠
□ Branco W/W
■ Preto B/B
▣ Branco/Preto W/B

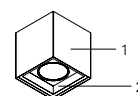

Legenda:
1. Corpo
2. Refletor

Temp. de Cor ♦
3000K 3
4000K 0

HOLI Sq /C



Características do produto

Corpo

Chapa de aço

Acabamento

Revestido a epóxi-poliéster

Sistema ótico

LIGHT+ - Difusor opalino

Fonte de luz

LED, RG1, CRI>80, MacAdam Step ≤3

Vida útil LED

60.000h @ L70, B10, Ta 25°C

Fonte de alimentação

Driver LED 220-240V-50/60Hz incluído



230V/50Hz



IP 40

650°C

01. Seleccionar versão

HOLI Sq /C

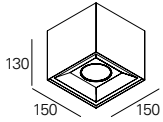

LIGHT+ - Difusor opalino

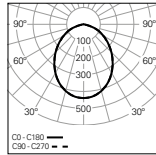

W
8
14

lm output
930
1576

lm/W
116
113

CÓDIGO*
90270L006♥♣0♦♣0
90270L110♥♣0♦♣0



*Substitua os símbolos para completar o código

Fonte de alimentação ▼
HF E
DALI H

Cor ♣/♠
□ Branco W/W
■ Preto B/B
▣ Branco/Preto W/B

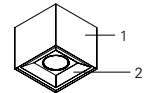

Legenda:
1. Corpo
2. Refletor

Temp. de Cor ♦
3000K 3
4000K 0

HOLI Sq /C Max



Características do produto

Corpo

Chapa de aço



Acabamento

Revestido a epóxi-poliéster

230V/50Hz

Sistema ótico

LIGHT+ - Difusor opalino

Fonte de luz

LED, RG1, CRI>80, MacAdam Step ≤3



IP 40

Vida útil LED

60.000h @ L70, B10, Ta 25°C

650°C

Fonte de alimentação

Driver LED 220-240V-50/60Hz incluído

01. Seleccionar versão

HOLI Sq /C Max

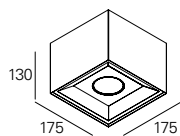

LIGHT+ - Difusor opalino

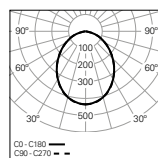

W
14
21
22

lm output
1576
2166
2492

lm/W
113
103
113

CÓDIGO*

90291L110	♥♣0♦♣0
90291L113	♥♣0♦♣0
90291L117	♥♣0♦♣0



*Substitua os símbolos para completar o código

Fonte de alimentação	
HF	E
DALI	H

Cor	
□ Branco	W/W
■ Preto	B/B
▣ Branco/Preto	W/B

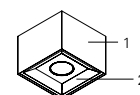

Legenda:
1. Corpo
2. Refletor

Temp. de Cor	
3000K	3
4000K	0







107

Iluminação
arquitetural

SENSE



SENSE
416



SENSE



Características do produto

Corpo

Alumínio

**Acabamento**

Revestido a epóxi-poliéster

230V/50Hz

Sistema ótico

DOZ - Difusor em policarbonato opalino

**Cablagem**

Cabo H05-FVV de L1000 mm

Fonte de luz

LED, RG1, CRI>80, MacAdam Step ≤3

**Vida útil LED**

50.000h @ L80, B10, Ta 25°C

Fonte de alimentação

Não incluída

Espessura do teto

Para tetos entre 1-25 mm

01. Selecionar versão

SENSE



DOZ - Difusor em policarbonato opalino

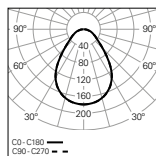

W	lm output	mA	Ø	CÓDIGO*
1	50	350	Ø46	90062L101E♣0♦00
3	84	700	Ø46	90062L103E♣0♦00



*Substitua os símbolos para completar o código

Cor	♣
□ Branco	W
■ Preto	B

Temp. de Cor	♦
3000K	3
4000K	0

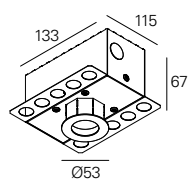

DOZ - Difusor em policarbonato opalino + Caixa de encastrar

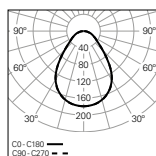

W	lm output	mA	Ø	CÓDIGO*
1	50	350	135x65	90854L101E♣0♦00
3	84	700	135x65	90854L103E♣0♦00

SENSE

- Para completar o produto é necessário encomendar fonte de alimentação em separado.

02. Selecionar opções

OPÇÕES

Código

Fonte de alimentação HF

Driver LED 350mA	965704
Driver LED 700mA	965705

Versão IP20/65

- Sob consulta.



FESAL



FESAL
420



FESAL Sq
422

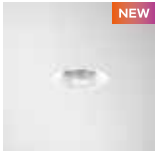

FESAL IP
424

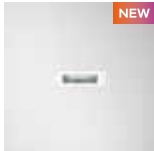

FESAL Sq IP
426



FESAL



Características do produto

Corpo

Alumínio



Acabamento

Revestido a epóxi-poliéster



Sistema ótico

PB - Refletor brilhante



Fonte de luz

LED, RG1, CRI>90, MacAdam Step ≤3

Vida útil LED

50.000h @ L80, B10, Ta 25°C

Fonte de alimentação

Não incluída

Espessura do teto

Para tetos entre 1-25 mm

01. Selecionar versão



FESAL

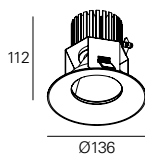

PB - Refletor brilhante | Ângulo de abertura de 35°

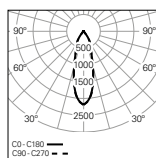

UGR	W	lm output	lm/W	mA	Ø	CÓDIGO*
≤13	7	932	143	200	Ø132	90019L00L0▲0◆35
≤16	12	1578	134	350	Ø132	90019L00H0▲0◆35

CG-C180 —
C90-C270 - -

PB - Refletor brilhante | Ângulo de abertura de 60°

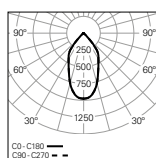

UGR	W	lm output	lm/W	mA	Ø	CÓDIGO*
≤19	7	953	146	200	Ø132	90019L00L0▲0◆60
≤19	12	1596	136	350	Ø132	90019L00H0▲0◆60

CG-C180 —
C90-C270 - -

*Substitua os símbolos para completar o código

Cor	◆
□ Branco	W
■ Preto	B

Temp. de Cor	◆
3000K	B
4000K	A

FESAL

- Para completar o produto é necessário encomendar fonte de alimentação em separado.

02. Selecionar opções

OPÇÕES

OPÇÕES	Código
Fonte de alimentação HF	
Driver 8,4W 10-42V 200mA HF	900001E
Driver 14,7W 10-42V 350mA HF	900004E
Fonte de alimentação DALI	
Driver 10,4W 09-52V 200mA DALI+ PUSH	900101H
Driver 18,2W 09-52V 350mA DALI+ PUSH	900104H
Cabo de segurança em aço	
L1500 mm	955000

FESAL Sq



Características do produto

Corpo

Chapa de aço

**Acabamento**

Revestido a epóxi-poliéster

**Sistema ótico**

PB - Refletor brilhante

**Fonte de luz**

LED, RG1, CRI>90, MacAdam Step ≤3

Vida útil LED

50.000h @ L80, B10, Ta 25°C

Fonte de alimentação

Não incluída

Espessura do teto

Para tetos entre 1-25 mm

01. Selecionar versão

FESAL Sq

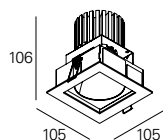

PB - Refletor brilhante | Ângulo de abertura de 35°

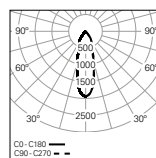

UGR	W	lm output	lm/W	mA	Φ	CÓDIGO*
≤16	8	796	122	200	95x93	90767L00L0♣0♦35
≤19	14	1330	113	350	95x93	90767L00H0♣0♦35

PB - Refletor brilhante | Ângulo de abertura de 60°

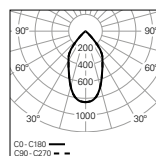

UGR	W	lm output	lm/W	mA	Φ	CÓDIGO*
≤22	8	817	125	200	95x93	90767L00L0♣0♦60
≤22	14	1347	115	350	95x93	90767L00H0♣0♦60



*Substitua os símbolos para completar o código

Cor ♣
 Branco W
 Preto B

Temp. de Cor ♦
 3000K B
 4000K A

FESAL Sq

• Para completar o produto é necessário encomendar fonte de alimentação em separado.

02. Selecionar opções

OPÇÕES

OPÇÕES	Código
Fonte de alimentação HF	
Driver 8,4W 10-42V 200mA HF	900001E
Driver 14,7W 10-42V 350mA HF	900004E
Fonte de alimentação DALI	
Driver 10,4W 09-52V 200mA DALI+ PUSH	900101H
Driver 18,2W 09-52V 350mA DALI+ PUSH	900104H
Cabo de segurança em aço	
L1500 mm	955000

FESAL IP



Características do produto

Corpo

Alumínio

Acabamento

Revestido a epóxi-poliéster

Sistema ótico

PB - Refletor brilhante

Polícarbonato transparente

Fonte de luz

LED, RG1, CRI>90, MacAdam Step ≤3

Vida útil LED

50.000h @ L80, B10, Ta 25°C

Fonte de alimentação

Não incluída

Espessura do teto

Para tetos entre 1-25 mm



01. Selecionar versão



FESAL IP

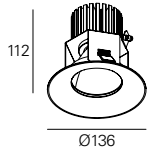

PB - Refletor brilhante | Ângulo de abertura de 35°

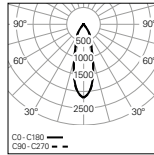

W	lm output	lm/W	mA	Ø	CÓDIGO*
8	932	143	200	Ø132	90765L00L0♣0♣35
14	1578	134	350	Ø132	90765L00H0♣0♣35

*Substitua os símbolos para completar o código

Cor	♣
□ Branco	W
■ Preto	B

Temp. de Cor	♣
3000K	B
4000K	A

PB - Refletor brilhante | Ângulo de abertura de 60°

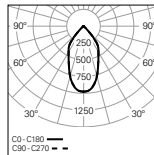

W	lm output	lm/W	mA	Ø	CÓDIGO*
8	953	146	200	Ø132	90765L00L0♣0♣60
14	1596	136	350	Ø132	90765L00H0♣0♣60

FESAL IP

• Para completar o produto é necessário encomendar fonte de alimentação em separado.

02. Selecionar opções

OPÇÕES Código

Fonte de alimentação HF	
Driver 8,4W 10-42V 200mA HF	900001E
Driver 14,7W 10-42V 350mA HF	900004E

Fonte de alimentação DALI	
Driver 10,4W 09-52V 200mA DALI+ PUSH	900101H
Driver 18,2W 09-52V 350mA DALI+ PUSH	900104H

Cabo de segurança em aço	
L1500 mm	955000

FESAL Sq IP



Características do produto

Corpo

Chapa de aço

Acabamento

Revestido a epóxi-poliéster

Sistema ótico

PB - Refletor brilhante
Policarbonato transparente

Fonte de luz

LED, RG1, CRI>90, MacAdam Step ≤3

Vida útil LED

50.000h @ L80, B10, Ta 25°C

Fonte de alimentação

Não incluída

Espessura do teto

Para tetos entre 1-25 mm



01. Selecionar versão

FESAL Sq IP

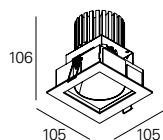

PB - Refletor brilhante | Ângulo de abertura de 35°

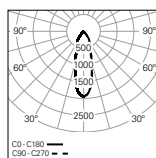

W	Im output	lm/W	mA	□	CÓDIGO*
8	796	122	200	95x93	90766L00L0♣0♦35
14	1330	113	350	95x93	90766L00H0♣0♦35

PB - Refletor brilhante | Ângulo de abertura de 60°

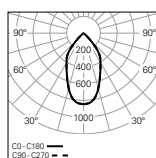

W	Im output	lm/W	mA	□	CÓDIGO*
8	817	125	200	95x93	90766L00L0♣0♦60
14	1347	115	350	95x93	90766L00H0♣0♦60



*Substitua os símbolos para completar o código

Cor ♣
 Branco W
 Preto B

Temp. de Cor ♦
 3000K B
 4000K A

FESAL Sq IP

- Para completar o produto é necessário encomendar fonte de alimentação em separado.

02. Selecionar opções

OPÇÕES

	Código
Fonte de alimentação HF	
Driver 8,4W 10-42V 200mA HF	900001E
Driver 14,7W 10-42V 350mA HF	900004E
Fonte de alimentação DALI	
Driver 10,4W 09-52V 200mA DALI+ PUSH	900101H
Driver 18,2W 09-52V 350mA DALI+ PUSH	900104H
Cabo de segurança em aço	
L1500 mm	955000



DYNA



DYNA MINI
430

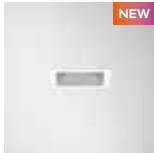

DYNA MINI Sq
432



DYNA MINI /C
434



DYNA
438

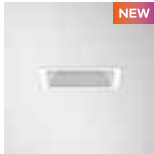

DYNA Sq
440



DYNA /C
442



DYNA IP
444

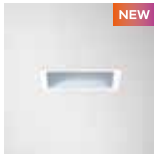

DYNA Sq IP
446



DYNA MINI



Características do produto

Corpo

Alumínio

**Acabamento**

Revestido a epóxi-poliéster

**Sistema ótico**

PM - Refletor mate

Fonte de luz

LED, RG1, CRI>90, MacAdam Step ≤3

**Vida útil LED**

50.000h @ L80, B10, Ta 25°C

Fonte de alimentação

Não incluída

Espessura do teto

Para tetos entre 1-20 mm

01. Selecionar versão

DYNA MINI

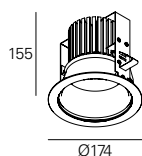

PM - Refletor mate

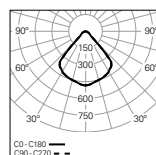

W	lm output	lm/W	mA	Ø	CÓDIGO*
8	1064	129	250	Ø155	90183L00L0♣0♦00
17	2125	128	500	Ø155	90183L00M0♣0♦00
24	2881	120	700	Ø155	90183L00H0♣0♦00



*Substitua os símbolos para completar o código

Cor	♣
□ Branco	W
■ Preto	B

Temp. de Cor	♦
3000K	B
4000K	A

DYNA MINI

- Para completar o produto é necessário encomendar fonte de alimentação em separado.

02. Selecionar opções



Detalhes do produto

OPÇÕES

Código

Fonte de alimentação HF

Driver 10,5W 10-42V 250mA HF	900002E
Driver 21W 10-42V 500mA HF	900007E
Driver 28W 28-40V 700mA HF	900303E

Fonte de alimentação DALI

Driver 13W 09-52V 250mA DALI+ PUSH	900102H
Driver 26W 09-52V 500mA DALI+ PUSH	900107H
Driver 26,3W 09-37,5V 700mA DALI+ PUSH	900111H

Cabo de segurança em aço

L1500 mm	955000
----------	--------



Downlight



Vista frontal

DYNA MINI Sq



Características do produto

Corpo

Chapa de aço

**Acabamento**

Revestido a epóxi-poliéster

**Sistema ótico**

PM - Refletor mate

Fonte de luz

LED, RG1, CRI>90, MacAdam Step ≤3

**Vida útil LED**

50.000h @ L80, B10, Ta 25°C

Fonte de alimentação

Não incluída

Espessura do teto

Para tetos entre 1-25 mm

01. Selecionar versão

DYNA MINI Sq

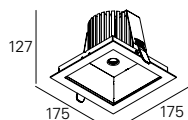

PM - Refletor mate

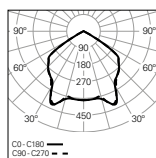

W	Im output	lm/W	mA	□	CÓDIGO*
8	1297	157	250	165x160	90760L00L0♣0♦00
17	2505	150	500	165x160	90760L00M0♣0♦00
24	3396	142	700	165x160	90760L00H0♣0♦00



*Substitua os símbolos para completar o código

Cor	♣
□ Branco	W
■ Preto	B

Temp. de Cor	♦
3000K	B
4000K	A

DYNA MINI Sq

• Para completar o produto é necessário encomendar fonte de alimentação em separado.

02. Selecionar opções

OPÇÕES

	Código
Fonte de alimentação HF	
Driver 10,5W 10-42V 250mA HF	900002E
Driver 21W 10-42V 500mA HF	900007E
Driver 28W 28-40V 700mA HF	900303E
Fonte de alimentação DALI	
Driver 13W 09-52V 250mA DALI+ PUSH	900102H
Driver 26W 09-52V 500mA DALI+ PUSH	900107H
Driver 26,3W 09-37,5V 700mA DALI+ PUSH	900111H
Cabo de segurança em aço	
L1500 mm	955000



Detalhes do produto



Downlight



Vista frontal

DYNA MINI /C



Características do produto

Corpo

Alumínio

Acabamento

Revestido a epóxi-poliéster

Sistema ótico

PM - Refletor mate

Fonte de luz

LED, RG1, CRI>90, MacAdam Step ≤3

Vida útil LED

50.000h @ L80, B10, Ta 25°C

Fonte de alimentação

Driver LED 220-240V-50/60Hz incluído



230V/50Hz



IP 20

650°C

01. Seleccionar versão



DYNA MINI /C

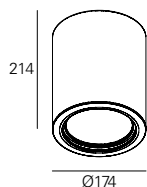

PM - Refletor mate

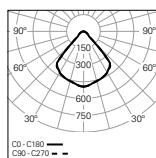

W
9
14
21

lm output
1064
1454
2125

lm/W
118
104
101

CÓDIGO*

90761L00L♥♣♦00
90761L00M♥♣♦00
90761L00H♥♣♦00

*Substitua os símbolos para completar o código

Fonte de alimentação ▼
HF E
DALI H

Cor ♣
□ Branco W
■ Preto B

Temp. de Cor ♦
3000K B
4000K A

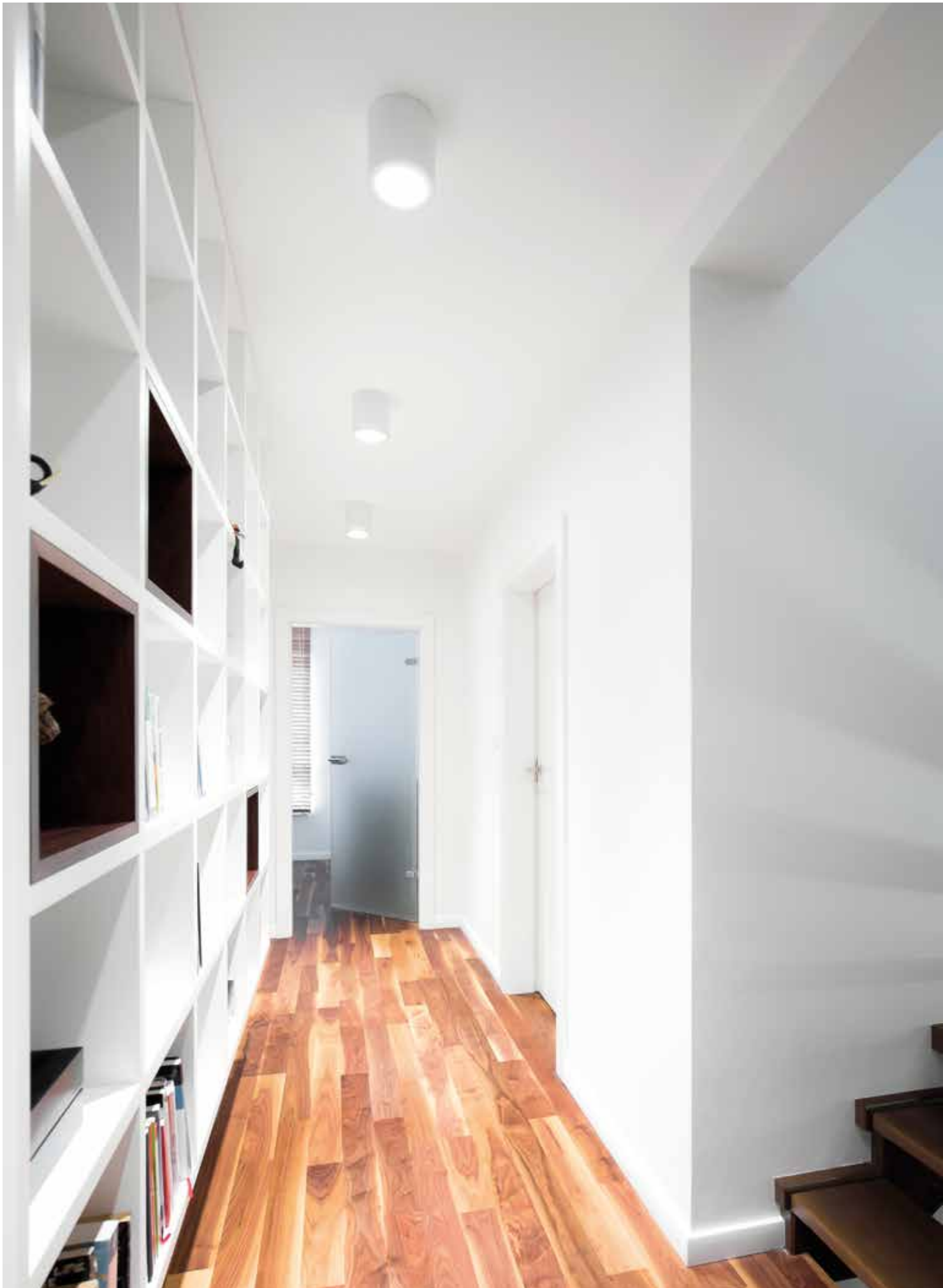



DYNA



Características do produto

Corpo

Alumínio



Acabamento

Revestido a epóxi-poliéster



Sistema ótico

EFFICIENT - Refletor mate de alto rendimento

CONTROL - Refletor mate para controlo de encandeamento



Fonte de luz

LED, RG1, CRI>80, MacAdam Step ≤3

Vida útil LED

60.000h @ L70, B10, Ta 25°C

Fonte de alimentação

Não incluída

Espessura do teto

Para tetos entre 1-25 mm

01. Selecionar versão



DYNA

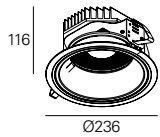

EFFICIENT - Refletor mate de alto rendimento | Ângulo de 80°

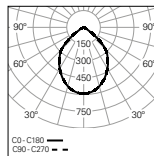

UGR	W	lm output	lm/W	mA	Φ	CÓDIGO*
≤19	8	1172	145	250	Ø220	90014L00L0♣0♦00
≤19	17	2283	135	500	Ø220	90014L00M0♣0♦00
≤22	24	3096	128	700	Ø220	90014L00H0♣0♦00

*Substitua os símbolos para completar o código

Cor	W
□ Branco	W
■ Preto	B

Temp. de Cor	♦
3000K	3
4000K	0

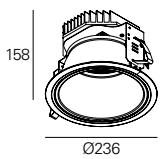

CONTROL - Refletor mate para controlo de encandeamento | Ângulo de 80°

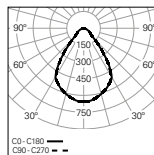

UGR	W	lm output	lm/W	mA	Φ	CÓDIGO*
≤16	8	1125	139	250	Ø220	90123L00L0♣0♦00
≤19	17	2168	128	500	Ø220	90123L00M0♣0♦00
≤19	24	3002	124	700	Ø220	90123L00H0♣0♦00

DYNA

• Para completar o produto é necessário encomendar fonte de alimentação em separado.

02. Selecionar opções



Detalhes do produto

OPÇÕES

Código

Fonte de alimentação HF

Driver 10,5W 10-42V 250mA HF	900002E
Driver 21W 10-42V 500MA HF	900007E
Driver 28W 28-40V 700MA HF	900303E

Fonte de alimentação DALI

Driver 13W 09-52V 250mA DALI+ PUSH	900102H
Driver 26W 09-52V 500MA DALI+ PUSH	900107H
Driver 26,3W 09-37,5V 700mA DALI+ PUSH	900111H

Cabo de segurança em aço

L1500 mm	955000
----------	--------

Kit de emergência (3 Horas)

• Sob consulta.



Dissipador passivo



Vista frontal

DYNA Sq



Características do produto

Corpo

Chapa de aço



Acabamento

Revestido a epóxi-poliéster



Sistema ótico

PM - Refletor mate

Fonte de luz

LED, RG1, CRI>80, MacAdam Step ≤3



Vida útil LED

60.000h @ L70, B10, Ta 25°C

Fonte de alimentação

Não incluída

Espessura do teto

Para tetos entre 1-25 mm

01. Selecionar versão

DYNA Sq

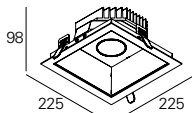

PM - Refletor mate

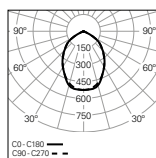

W	lm output	lm/W	mA	Φ	CÓDIGO*
8	1172	145	250	209x209	90757L00L0♣0♦00
17	2283	135	500	209x209	90757L00M0♣0♦00
24	3096	128	700	209x209	90757L00H0♣0♦00



*Substitua os símbolos para completar o código

Cor 
 Branco W
 Preto B

Temp. de Cor 
 3000K 3
 4000K 0

DYNA Sq

• Para completar o produto é necessário encomendar fonte de alimentação em separado.

02. Selecionar opções

OPÇÕES Código

Fonte de alimentação HF

Driver 10,5W 10-42V 250mA HF	900002E
Driver 21W 10-42V 500MA HF	900007E
Driver 28W 28-40V 700MA HF	900303E

Fonte de alimentação DALI

Driver 13W 09-52V 250mA DALI+ PUSH	900102H
Driver 26W 09-52V 500MA DALI+ PUSH	900107H
Driver 26,3W 09-37,5V 700mA DALI+ PUSH	900111H

Cabo de segurança em aço

L1500 mm	955000
----------	--------

Kit de emergência (3 Horas)

• Sob consulta.



Detalhes do produto



Vista frontal

DYNA /C



Características do produto

Corpo

Alumínio

**Acabamento**

Revestido a epóxi-poliéster

230V/50Hz

Sistema ótico

PM - Refletor mate



IP 20

Fonte de luz

LED, RG1, CRI>80, MacAdam Step ≤ 3

Vida útil LED

60.000h @ L70, B10, Ta 25°C

650°C

Fonte de alimentação

Driver LED 220-240V-50/60Hz incluído

01. Seleccionar versão



DYNA / C

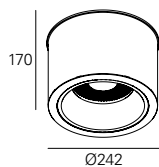

PM - Refletor mate

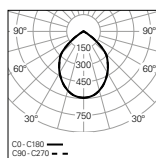

W
9
19
28

lm output
1172
2283
3096

lm/W
130
120
111

CÓDIGO*

90759L00L♥♣0♦00
90759L00M♥♣0♦00
90759L00H♥♣0♦00

*Substitua os símbolos para completar o código

Fonte de alimentação ▼
HF E
DALI H

Cor ▲
□ Branco W
■ Preto B

Temp. de Cor ♦
3000K 3
4000K 0

DYNA IP



Características do produto

Corpo

Alumínio

**Acabamento**

Revestido a epóxi-poliéster

**Sistema ótico**

Vidro temperado opalino

**Fonte de luz**

LED, RG1, CRI>80, MacAdam Step ≤3

Vida útil LED

60.000h @ L70, B10, Ta 25°C

**Fonte de alimentação**

Não incluída

Espessura do teto

Para tetos entre 1-20 mm

01. Selecionar versão

DYNA IP

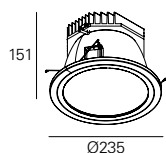

Vidro temperado opalino

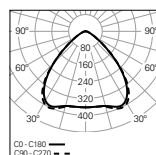

W	lm output	lm/W	mA	Ø	CÓDIGO*
17	2326	138	500	Ø215	90136L00L0♣0♦00
24	3121	129	700	Ø215	90136L00M0♣0♦00
32	3884	121	900	Ø215	90136L00H0♣0♦00



*Substitua os símbolos para completar o código

Cor	♣
□ Branco	W
■ Preto	B

Temp. de Cor	♦
3000K	3
4000K	0

DYNA IP

- Para completar o produto é necessário encomendar fonte de alimentação em separado.

02. Selecionar opções



Detalhes do produto

OPÇÕES

Código

Fonte de alimentação HF

Driver 21W 10-42V 500mA HF	900007E
Driver 28W 28-40V 700mA HF	900303E
Driver 37,8W 30-42V 900mA HF	900500E

Fonte de alimentação DALI

Driver 26W 09-52V 500MA DALI+ PUSH	900107H
Driver 26,3W 09-37,5V 700mA DALI+ PUSH	900111H
Driver 44,1W 09-49V 900mA DALI+ PUSH	900604H

Cabo de segurança em aço

L1500 mm	955000
----------	--------

Kit de emergência (3 Horas)

- Sob consulta.



Niveladores

DYNA Sq IP

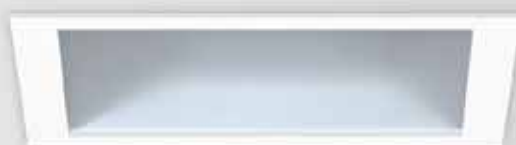

Características do produto

Corpo

Chapa de aço



Acabamento

Revestido a epóxi-poliéster



Sistema ótico

Vidro temperado opalino



Fonte de luz

LED, RG1, CRI>80, MacAdam Step ≤3

Vida útil LED

60.000h @ L70, B10, Ta 25°C



Fonte de alimentação

Não incluída

Espessura do teto

Para tetos entre 1-25 mm

01. Selecionar versão

DYNA Sq IP

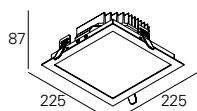

Vidro temperado opalino

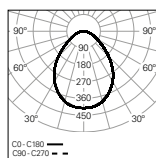

W	lm output	lm/W	mA	▣	CÓDIGO*
17	2326	138	500	209x209	90758L00L0♣0♦00
24	3121	129	700	209x209	90758L00M0♣0♦00
32	3884	121	900	209x209	90758L00H0♣0♦00



*Substitua os símbolos para completar o código

Cor	♣
□ Branco	W
■ Preto	B

Temp. de Cor	♦
3000K	3
4000K	0

DYNA Sq IP

- Para completar o produto é necessário encomendar fonte de alimentação em separado.

02. Selecionar opções

OPÇÕES

Fonte de alimentação HF

Driver 21W 10-42V 500mA HF	900007E
Driver 28W 28-40V 700mA HF	900303E
Driver 37,8W 30-42V 900mA HF	900500E

Fonte de alimentação DALI

Driver 26W 09-52V 500MA DALI+ PUSH	900107H
Driver 26,3W 09-37,5V 700mA DALI+ PUSH	900111H
Driver 44,1W 09-49V 900mA DALI+ PUSH	900604H

Cabo de segurança em aço

L1500 mm	955000
----------	--------

Kit de emergência (3 Horas)

- Sob consulta.



Detalhes do produto



Vista frontal







Iluminação
arquitetural

AURA



AURA
452



AURA

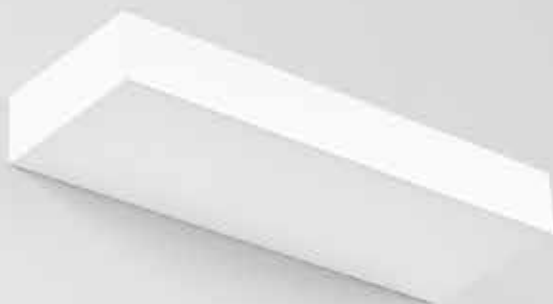

Características do produto

Corpo

Chapa de aço



Acabamento

Revestido a epóxi-poliéster

230V/50Hz

Sistema ótico

LIGHT+ - Difusor opalino



Fonte de luz

LED, RG1, CRI>80, MacAdam Step ≤ 3

Vida útil LED

80.000h @ L80, B10, Ta 25°C



Fonte de alimentação

Driver LED 220-240V-50/60Hz incluído

01. Seleccionar versão



AURA

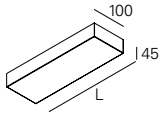

LIGHT+ - Difusor opalino

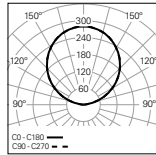

W	lm output	lm/W	Lmm	CÓDIGO*
16	2017	126	300	90825L030▼▲◆00
31	4034	130	600	90825L060▼▲◆00

*Substitua os símbolos para completar o código

Fonte de alimentação	
HF	E
DALI	H

Cor ¹	
<input type="checkbox"/> Branco	W
<input type="checkbox"/> Preto	B

Temp. de Cor	
3000K	3
4000K	0



Detalhes do produto



Difusor

¹ Outras cores sob consulta.

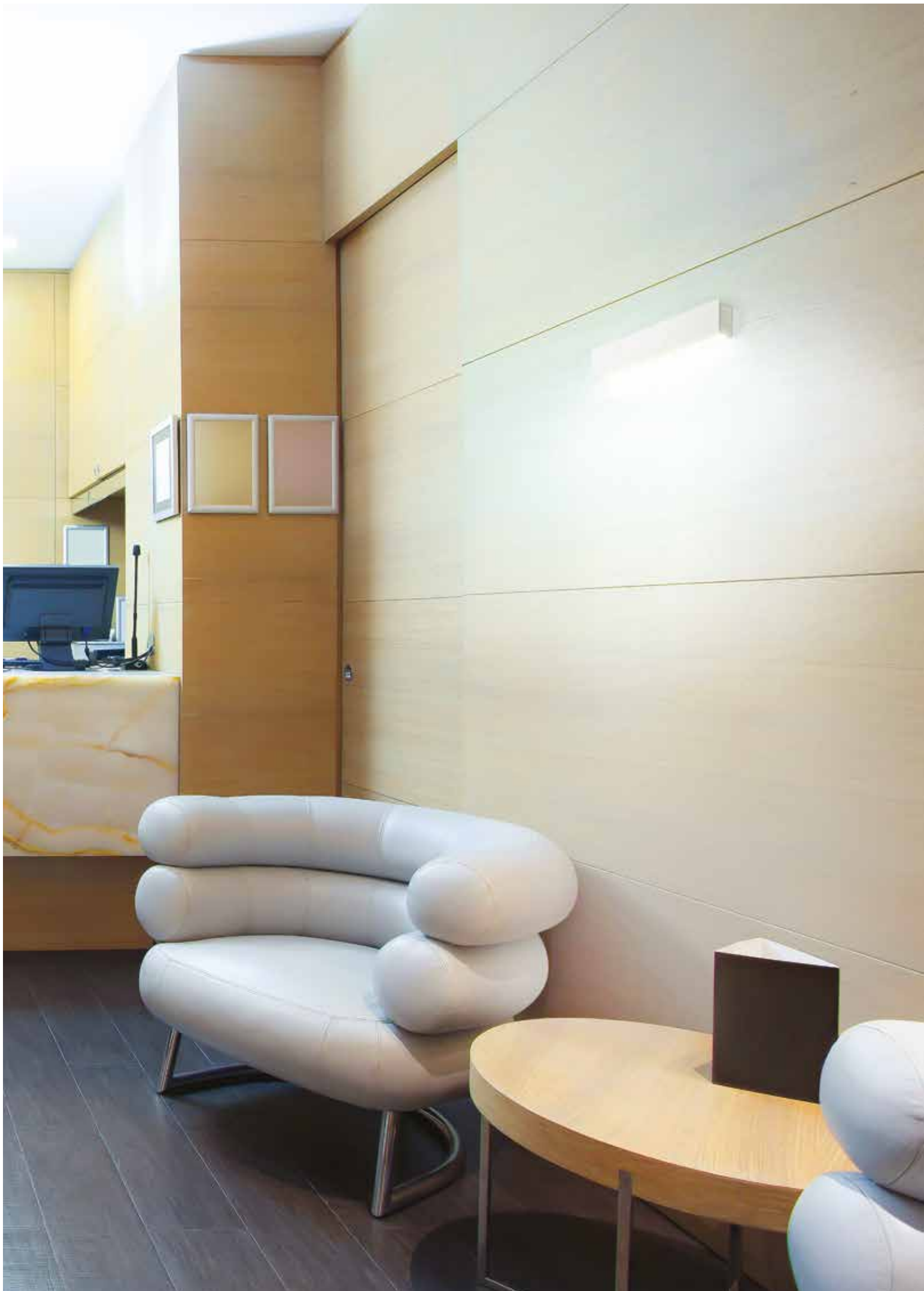

Iluminação
arquitetural

SLIM



SLIM
456



SLIM



Características do produto

Corpo

Chapa de aço



Acabamento

Revestido a epóxi-poliéster

230V/50Hz

Sistema ótico

LIGHT+ - Difusor opalino



Fonte de luz

LED, RG1, CRI>80, MacAdam Step ≤ 3

Vida útil LED

80.000h @ L90, B10, Ta 25°C



Fonte de alimentação

Driver LED 220-240V-50/60Hz incluído

01. Selecionar versão

SLIM

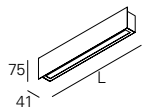

LIGHT+ - Difusor opalino

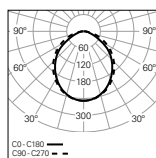

W	lm output	lm/W	Lmm	CÓDIGO*
8	802	100	350	90833L350▼▲0◆00
15	1603	107	590	90833L590▼▲0◆00



*Substitua os símbolos para completar o código

Fonte de alimentação ▼

HF E
DALI H

Cor ¹ ▲

□ Branco W
■ Preto B

Temp. de Cor ◆

3000K 3
4000K 0



Detalhes do produto



Proporção do produto



Iluminação
arquitetural

VISA



VISA
460



VISA

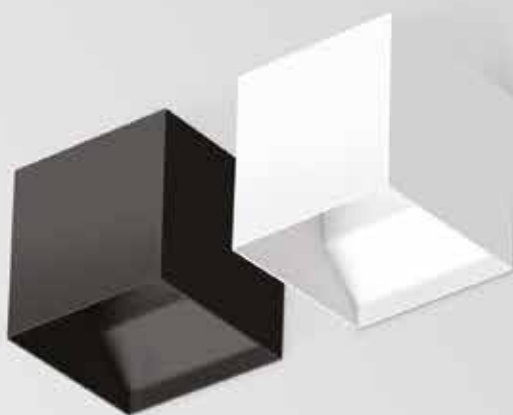

Características do produto

Corpo

Chapa de aço

Acabamento

Revestido a epóxi-poliéster

Fonte de luz

LED, RG1, CRI>80, MacAdam Step ≤3

Vida útil LED

50.000h @ L80, B10, Ta 25°C

Fonte de alimentação

Driver LED 220-240V-50/60Hz incluído



230V/50Hz



IP 20

650°C

01. Selecionar versão



VISA

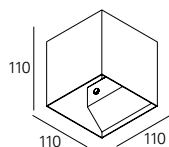

Direta / Indireta | Ângulo de abertura de 90° + 90°

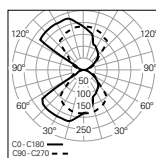

W
3
5

lm output
141
232

CÓDIGO*
90220L101E♣0♦90
90220L103E♣0♦90

*Substitua os símbolos para completar o código

Cor ♣

□ Branco	W
■ Preto	B
■ Sahara	0
■ Carbon	I
■ Rusty chain	R
■ Golden eye	D

Direta / Indireta | Ângulo de abertura de 90° + 5°

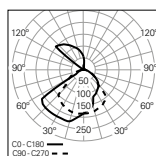

W
3
5

lm output
80
143

CÓDIGO*
90220L101E♣0♦05
90220L103E♣0♦05

Temp. de Cor ♦

3000K	3
4000K	0
5700K	5

SISTEMAS E PERFIS DE ALUMÍNIO





Sistemas e perfis
de alumínio

REBA 50 bOPTICS

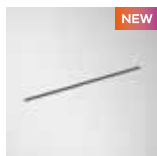

**REBA 50 /E
bOPTICS**
474

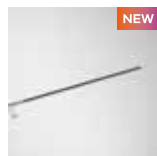

**REBA 50 /E
bOPTICS Line**
478



REBA 50 bOPTICS
484



**REBA 50 bOPTICS
Line**
488



Tipos de aplicação

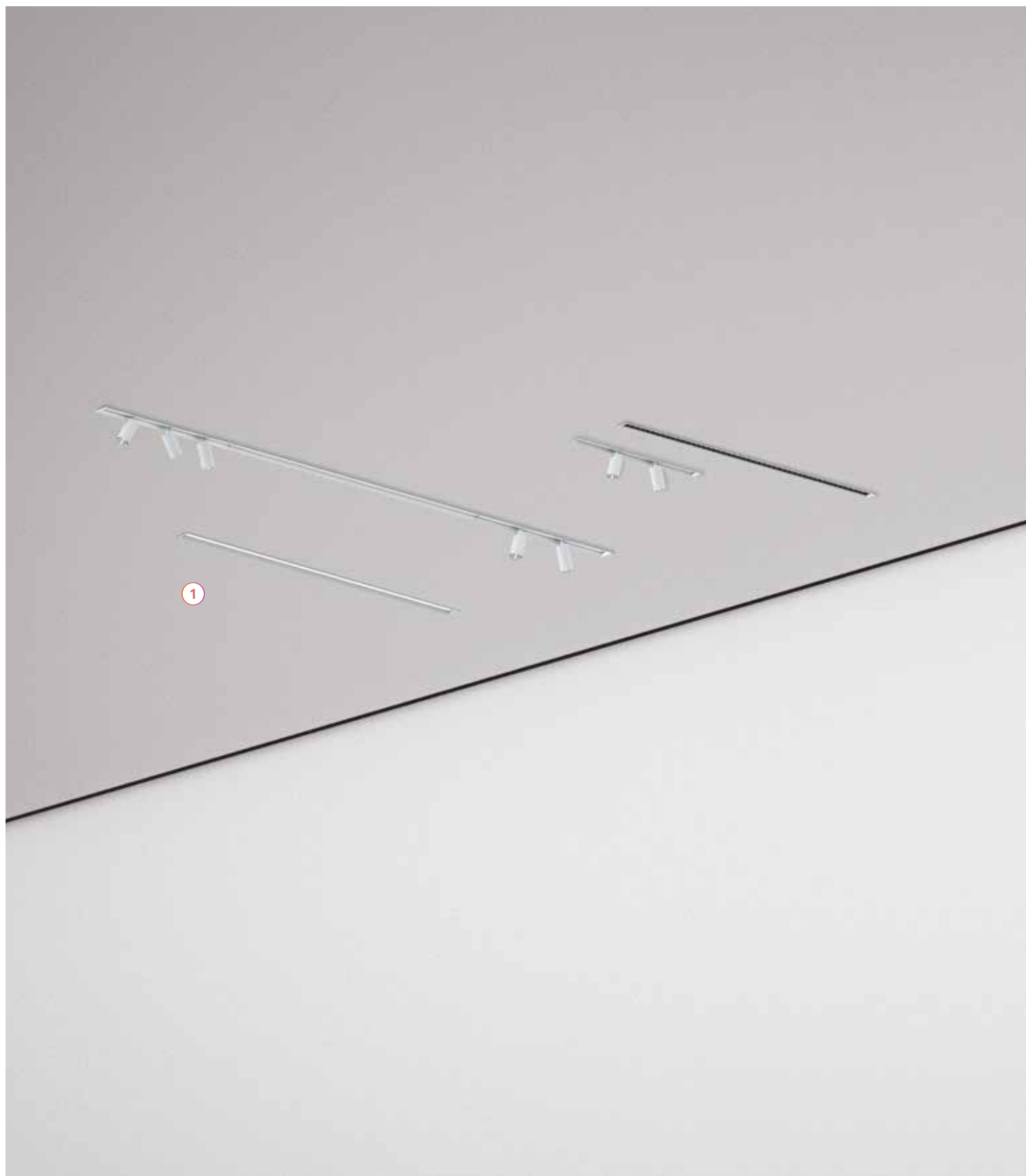

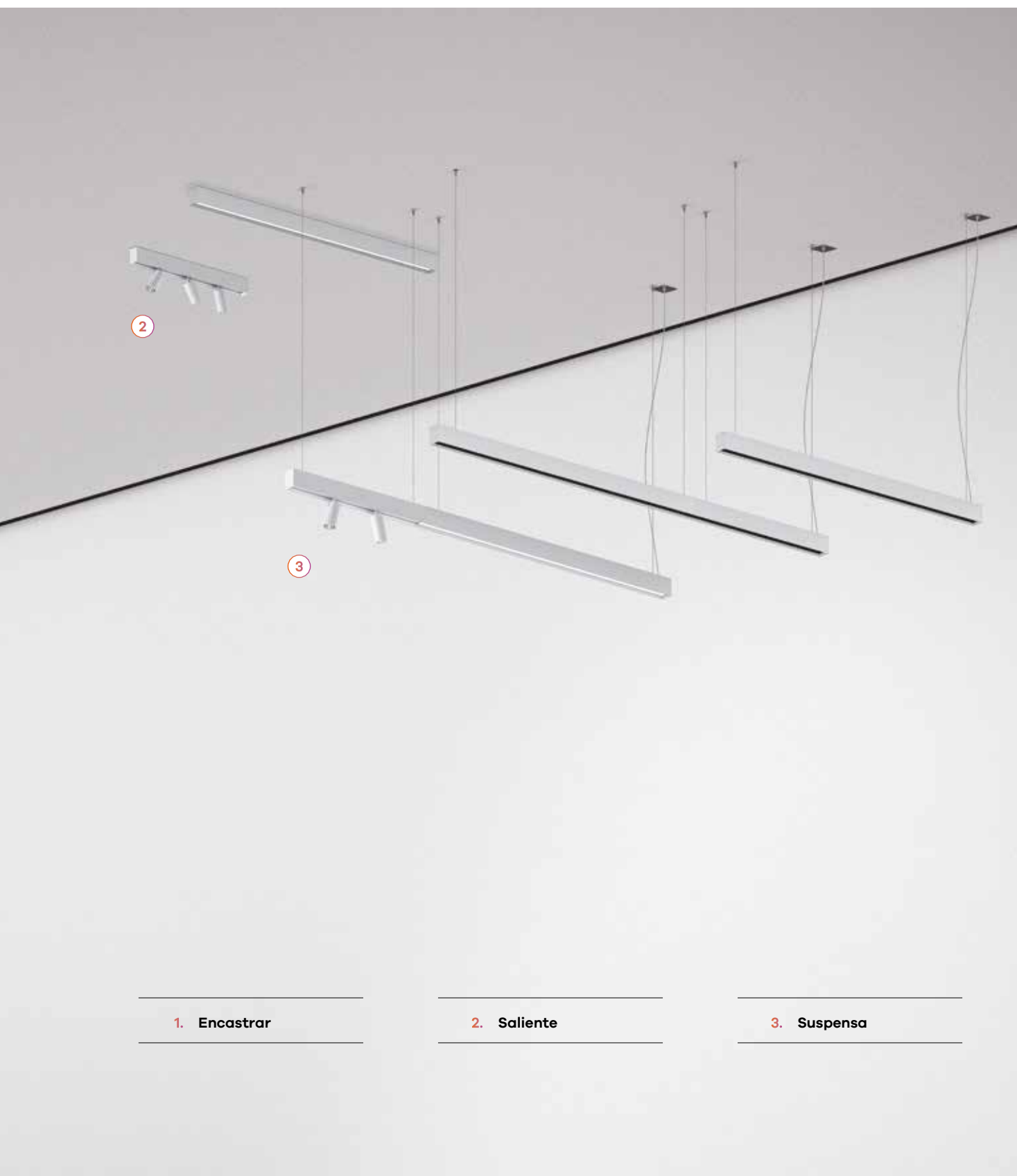

Sistema óptico

1. bFLEX

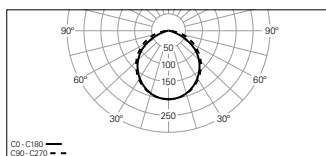

2. bOPTICS

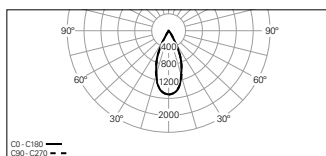

3. SPOT

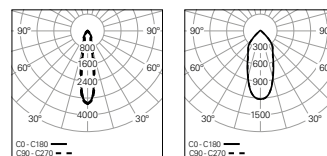



Minimalismo e tecnologia

1. Perfil exterior

Perfil de alumínio extrudido, disponível em 3 cores.

2. LED

SDCM MacAdam ≤ 3 , temperatura de cor 3000K / 4000K, CRI > 80 e vida útil de 80.000h L90 B10.

3. bOPTICS, bFLEX ou SPOT

Sistema ótico de alta tecnologia com refletor bOPTICS para uma iluminação de elevado conforto visual (UGR < 10), difusor opalino bFLEX que garante uma luz suave e uniforme sem pontos visíveis ou versão SPOT para uma iluminação de destaque, com 1, 2 ou 3 SPOTS disponíveis.

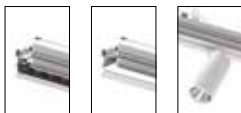

4. Topo

Topos sem parafusos visíveis e sem saída de luz. Disponíveis na cor do produto.

5. Fonte de alimentação DALI ou HF

6. Suspensão e cabo de alimentação

Suspensão e cabo de alimentação disponíveis com comprimento de 1500, 3000 ou 6000 mm.



7. Caixa de alimentação

Caixas de alimentação nas versões de encastrar ou saliente disponíveis na cor branca ou preta.

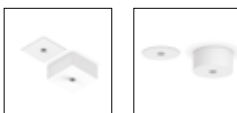

8. União

Os dois perfis são perfeitamente conectados para que não haja saída de luz em qualquer aplicação de linha contínua.



9. Kit de emergência

Kit de emergência de 3 horas. Disponível desde ≈ 1276 mm.

10. Niveladores

A versão de encastrar tem instalação fácil garantida devido a um suporte de montagem inteligente para instalação em tetos de até 25 mm de espessura.



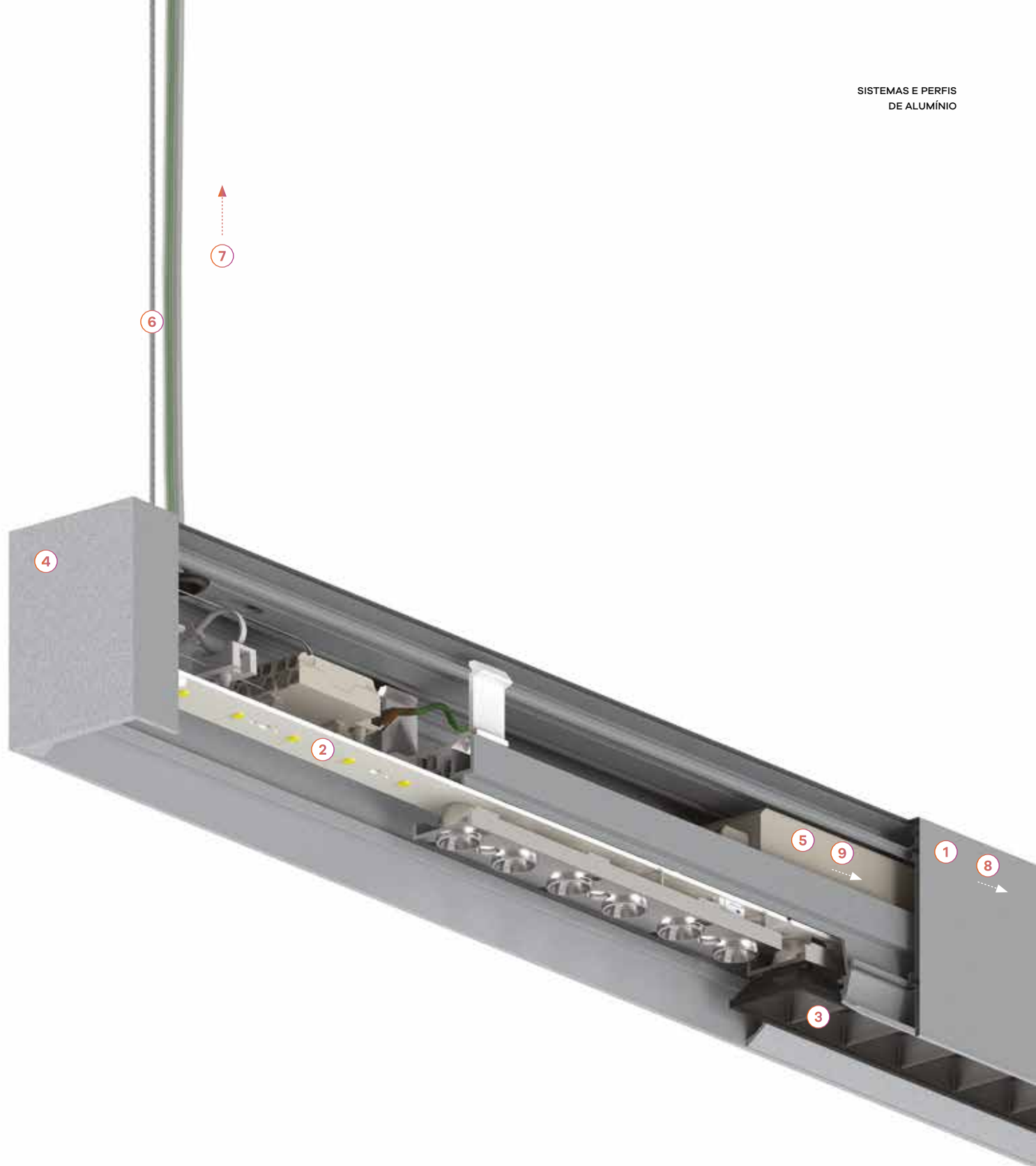

Composição de elementos estruturais

1. Topos

2. Perfil exterior

- 2.1 Módulo início / fim (SRT/END).
- 2.2 Módulo intermédio (MID).

3. Perfil interior

- 3.1 bOPTICS
- 3.2 bFLEX
- 3.3 Módulo cego
- 3.4 Spot 1
- 3.5 Spot 2
- 3.6 Spot 3

4. Uniões

5. Caixas de alimentação

6. Cabo de alimentação

7. Suspensão

Módulos disponíveis

(Vista de cima)

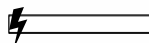

Módulo início / fim (SRT/END)



Módulo intermédio (MID)

Como estruturar uma linha

(Vista de cima)



Topo

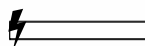

Módulo início / fim (SRT/END)

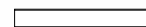

Módulo intermédio (MID)

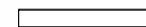

Módulo início / fim (SRT/END)



Topo



Esquema elétrico (K3)

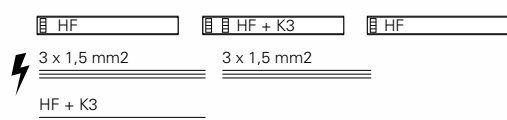

Esquema elétrico (K3 + Telecomando)

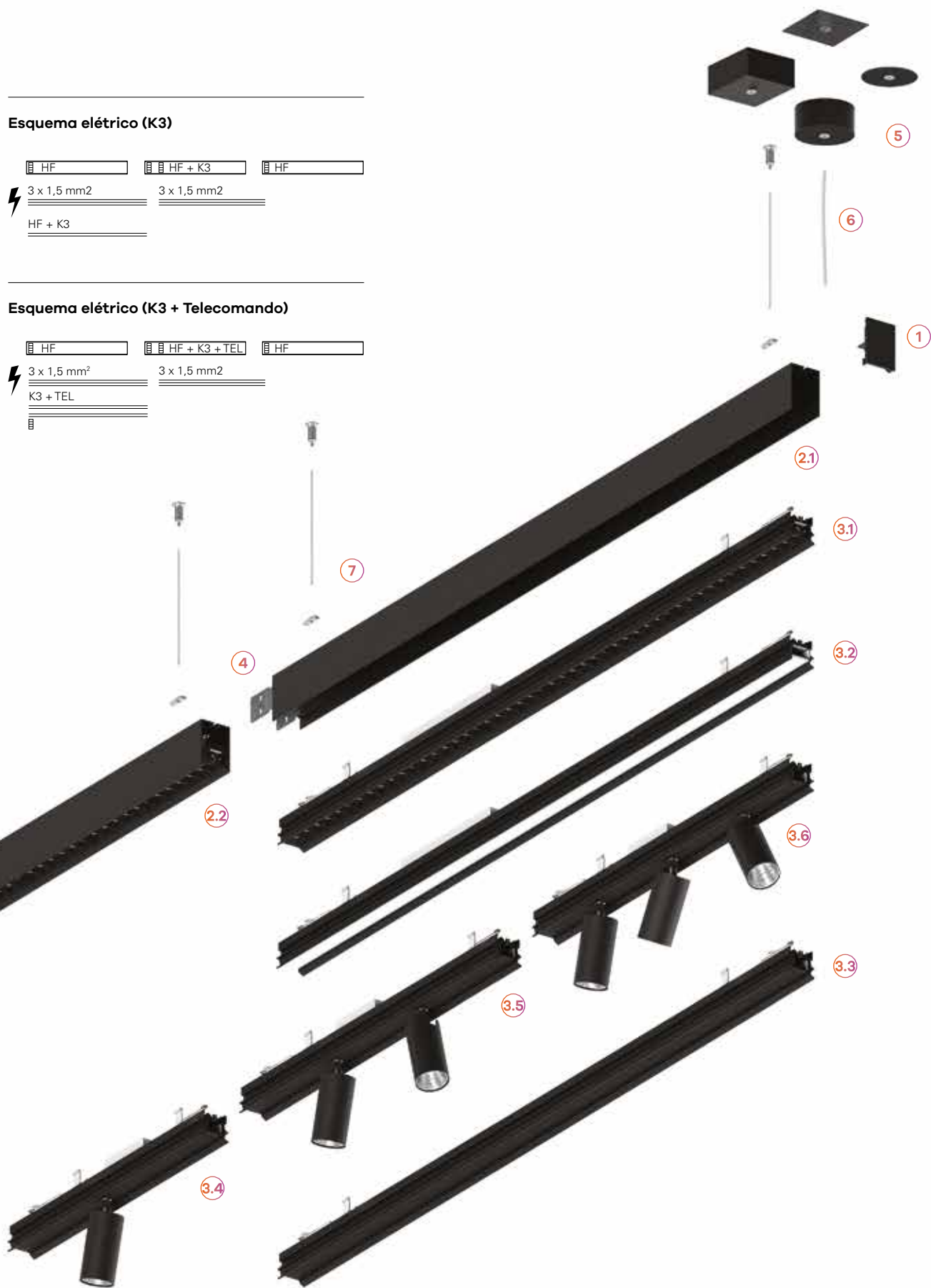
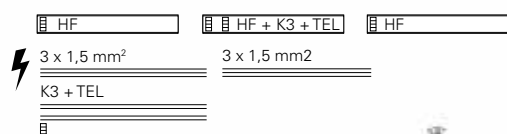

REBA 50 /E bOPTICS



Características do produto

Corpo

Perfil de alumínio extrudido

Acabamento

Revestido a epóxi-poliéster

Sistema ótico

bFLEX - Difusor opalino

bOPTICS - Refletor simétrico

PB - Refletor brilhante

Fonte de luz

Perfil interior: LED, RG1, CRI>80,

MacAdam Step ≤3

Spot: LED, RG1, CRI>90, MacAdam Step ≤3

Vida útil LED

Perfil interior: 80.000h @ L90, B10, Ta 25°C

Spot: 86.000h @ L80, B10, Ta 25°C

Fonte de alimentação

Driver LED 220-240V-50/60Hz incluído

Espessura do teto

Para tetos entre 1-25 mm

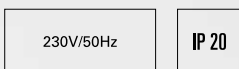

01. Seleccionar perfil exterior

PERFIL EXTERIOR

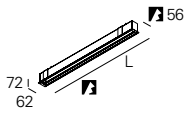

Lmm	56	CÓDIGO*
675	665	90745L0020♣0000
993	983	90745L0030♣0000
1311	1301	90745L0040♣0000
1629	1619	90745L0050♣0000
1948	1938	90745L0060♣0000
2266	2256	90745L0070♣0000
2585	2575	90745L0080♣0000
2903	2893	90745L0090♣0000



*Substitua os símbolos para completar o código

Cor	♣
□ Branco	W
■ Cinzento	G
■ Preto	B

PERFIL EXTERIOR

• Para completar o produto é necessário encomendar o perfil interior em separado.

02. Seleccionar interior

PERFIL INTERIOR

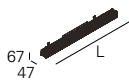

bOPTICS - Refleto simétrico 48°

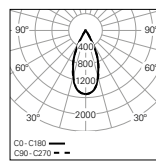

UGR	W	lm output	lm/W	Lmm	CÓDIGO*
≤10	12	1488	124	637	90747L002♥♣0♦00
≤10	18	2233	124	955	90747L003♥♣0♦00
≤10	24	2977	124	1273	90747L004♥♣♦♦00
≤10	30	3721	124	1591	90747L005♥♣♦♦00
≤10	34	4465	131	1910	90747L006♥♣♦♦00
≤10	39	5209	134	2228	90747L007♥♣♦♦00
≤10	45	5953	132	2547	90747L008♥♣♦♦00
≤10	50	6698	134	2865	90747L009♥♣♦♦00

*Substitua os símbolos para completar o código

Fonte de alimentação	♥
HF	E
DALI	H

Cor	♣
□ Branco	W
■ Cinzento	G
■ Preto	B

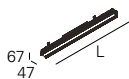

bFLEX - Difusor opalino

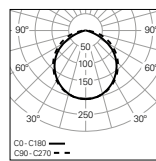

UGR	W	lm output	lm/W	Lmm	CÓDIGO*
≤25	12	1017	85	637	90748L002♥♣0♦00
≤25	18	1526	85	955	90748L003♥♣0♦00
≤25	24	2035	85	1273	90748L004♥♣♦♦00
≤25	30	2543	85	1591	90748L005♥♣♦♦00
≤25	34	3052	90	1910	90748L006♥♣♦♦00
≤25	39	3561	91	2228	90748L007♥♣♦♦00
≤25	45	4069	90	2547	90748L008♥♣♦♦00
≤25	50	4578	92	2865	90748L009♥♣♦♦00

Emergência	●
No EM	0
EM 3h (K3) ¹	3

Temp. de Cor	♦
3000K	3
4000K	0

¹ Preparado para telecomando.

02. Seleccionar interior

SPOT - Projektor

Spot 1



Spot 2



Spot 3



PB - Reflektor brilhante 20°

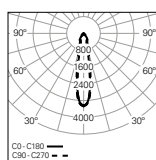

SPOT	W	lm output	lm/W	Lmm	CÓDIGO*
1	11	1168	106	318	90749L001E♣0♣♣2
1	11	1168	106	637	90749L002♥♣0♣♣2
2	21	2336	111	318	90750L001E♣0♣♣2
2	21	2336	111	637	90750L002♥♣0♣♣2
3	30	3504	117	637	90751L002♥♣0♣♣2

PB - Reflektor brilhante 50°

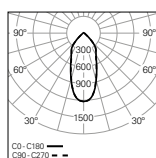

SPOT	W	lm output	lm/W	Lmm	CÓDIGO*
1	11	1144	104	318	90749L001E♣0♣♣5
1	11	1144	104	637	90749L002♥♣0♣♣5
2	21	2288	109	318	90750L001E♣0♣♣5
2	21	2288	109	637	90750L002♥♣0♣♣5
3	30	3431	114	637	90751L002♥♣0♣♣5



*Substitua os símbolos para completar o código

Fonte de alimentação	
HF	E
DALI	H

Cor	
□ Branco	W/W
■ Preto	B/B
■ Cinzento	G/G
□ Branco/Preto	W/B
■ Preto/Branco	B/W
■ Preto/Golden eye	B/D



Legenda:
1. Corpo
2. Spot

Temp. de Cor	
3000K	B
4000K	A

03. Selecionar opções

OPÇÕES	Código
Cabo de segurança em aço L1500 mm	955000
Versão Low Output • Sob consulta.	



Detalhes do produto



Perfil exterior



Nivelador



Aplicação de encastrar

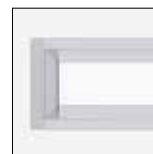

Difusor bFLEX



Difusor bOPTICS



Spot orientável



Acabamento em branco



Acabamento em preto



Acabamento em cinzento



Acabamento em branco/preto



Acabamento em preto/branco



Acabamento em preto/golden eye

REBA 50 /E bOPTICS Line



Características do produto

Corpo

Perfil de alumínio extrudido

Acabamento

Revestido a epóxi-poliéster

Sistema ótico

bFLEX - Difusor opalino

bOPTICS - Refletor simétrico

PB - Refletor brilhante

Fonte de luz

Perfil interior: LED, RG1, CRI>80,

MacAdam Step ≤3

Spot: LED, RG1, CRI>90, MacAdam Step ≤3

Vida útil LED

Perfil interior: 80.000h @ L90, B10, Ta 25°C

Spot: 86.000h @ L80, B10, Ta 25°C

Fonte de alimentação

Driver LED 220-240V-50/60Hz incluído

Espessura do teto

Para tetos entre 1-25 mm

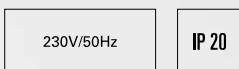

01. Selecionar perfil exterior

PERFIL EXTERIOR

Início / Fim (SRT/END)

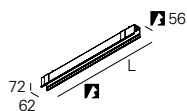

Lmm		CÓDIGO*
647	648	90746L0020▲0083
965	966	90746L0030▲0083
1283	1284	90746L0040▲0083
1601	1602	90746L0050▲0083
1920	1921	90746L0060▲0083
2238	2239	90746L0070▲0083
2557	2558	90746L0080▲0083
2875	2876	90746L0090▲0083

Intermédio (MID)

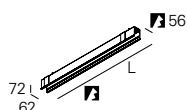

Lmm		CÓDIGO*
637	637	90746L0020▲0000
955	955	90746L0030▲0000
1273	1273	90746L0040▲0000
1591	1591	90746L0050▲0000
1910	1910	90746L0060▲0000
2228	2228	90746L0070▲0000
2547	2547	90746L0080▲0000
2865	2865	90746L0090▲0000

PERFIL EXTERIOR

- Para completar o produto é necessário encomendar o perfil interior em separado.
- Para completar a linha é necessário encomendar start kit, cablagem de linha contínua e kit de união em separado.
- Dimensões não incluem start kit. Adicione 6 mm ao comprimento de corte para completar a dimensão de encaixe da linha.
- O comprimento máximo da linha com um único ponto de alimentação é 30000 mm.



*Substitua os símbolos para completar o código

Cor	▲
<input type="checkbox"/> Branco	W
<input type="checkbox"/> Cinzento	G
<input type="checkbox"/> Preto	B

02. Selecionar interior

PERFIL INTERIOR

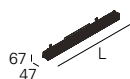

bOPTICS - Refletor simétrico 48°

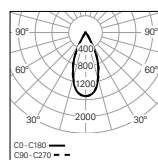

UGR	W	Im output	Im/W	Lmm	CÓDIGO*
≤10	12	1488	124	637	90747L002▼▲0♦00
≤10	18	2233	124	955	90747L003▼▲0♦00
≤10	24	2977	124	1273	90747L004▼▲0♦00
≤10	30	3721	124	1591	90747L005▼▲0♦00
≤10	34	4465	131	1910	90858L006▼▲0♦00
≤10	39	5209	134	2228	90858L007▼▲0♦00
≤10	45	5953	132	2547	90858L008▼▲0♦00
≤10	50	6698	134	2865	90858L009▼▲0♦00

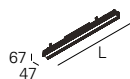

bFLEX - Difusor opalino

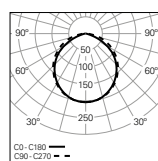

UGR	W	Im output	Im/W	Lmm	CÓDIGO*
≤25	12	1017	85	637	90748L002▼▲0♦00
≤25	18	1526	85	955	90748L003▼▲0♦00
≤25	24	2035	85	1273	90748L004▼▲0♦00
≤25	30	2543	85	1591	90748L005▼▲0♦00
≤25	34	3052	90	1910	90859L006▼▲0♦00
≤25	39	3561	91	2228	90859L007▼▲0♦00
≤25	45	4069	90	2547	90859L008▼▲0♦00
≤25	50	4578	92	2865	90859L009▼▲0♦00



*Substitua os símbolos para completar o código

Fonte de alimentação	▼
HF	E
DALI	H

Cor	▲
<input type="checkbox"/> Branco	W
<input type="checkbox"/> Cinzento	G
<input type="checkbox"/> Preto	B

Emergência	●
No EM	0
EM 3h (K3) ¹	3

Temp. de Cor	♦
3000K	3
4000K	0

¹ Preparado para telecomando.

02. Seleccionar interior

SPOT - Projetor

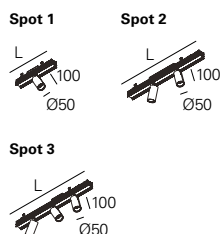

PB - Refletor brilhante 20°

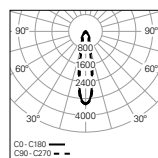

SPOT	W	Im output	Im/W	Lmm	CÓDIGO*
1	11	1168	106	318	90749L001E♣0♣♠2
1	11	1168	106	637	90749L002♥♣0♣♠2
2	21	2336	111	318	90750L001E♣0♣♠2
2	21	2336	111	637	90750L002♥♣0♣♠2
3	30	3504	117	637	90751L002♥♣0♣♠2

PB - Refletor brilhante 50°

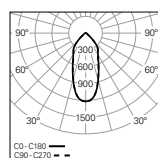

SPOT	W	Im output	Im/W	Lmm	CÓDIGO*
1	11	11	11	318	90749L001E♣0♣♠5
1	11	11	11	637	90749L002♥♣0♣♠5
2	21	21	21	318	90750L001E♣0♣♠5
2	21	21	21	637	90750L002♥♣0♣♠5
3	30	30	30	637	90751L002♥♣0♣♠5

SPOT - Projetor

• A versão SPOT L318 mm apenas pode ser aplicado no fim da linha (END).



*Substitua os símbolos para completar o código

Fonte de alimentação	
HF	E
DALI	H

Cor	
□ Branco	W/W
■ Preto	B/B
■ Cinzento	G/G
□ Branco/Preto	W/B
■ Preto/Branco	B/W
■ Preto/Golden eye	B/D



Legenda:

1. Corpo
2. Spot

Temp. de Cor	
3000K	B
4000K	A



*Substitua os símbolos para completar o código

MÓDULO CEGO

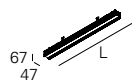

Lmm	CÓDIGO*
318	90744L0010♣0000
637	90744L0020♣0000
955	90744L0030♣0000
1273	90744L0040♣0000
1591	90744L0050♣0000
1910	90744L0060♣0000
2228	90744L0070♣0000
2547	90744L0080♣0000
2865	90744L0090♣0000

Cor	
□ Branco	W
■ Cinzento	G
■ Preto	B

03. Selecionar opções

OPÇÕES		Código*
Start kit - topo início/fim	72 62 9	923210
• Dois topos incluídos.		
Cablagem linha contínua		
• Standard		
3 x 1,5 mm ²		945650
5 x 1,5 mm ²		945750
• 2 x 1,5 mm²		
HF+K3 (x1) - L638 - L1914 mm		948000
HF+K3 (x2) - L2233 - L2871 mm		948001
• 2 x 1,5 mm² + Junção 5P		
DALI+K3 (x1) - L638 - L1914 mm		948200
DALI+K3 (x2) - L2233 - L2871 mm		948201
• 2 x 1,5 mm² + 2 x 0,75 mm² + Junção 5P		
K3+TEL (x1) - L638 - L1914 mm		948100
K3+TEL (x2) - L2233 - L2871 mm		948101
Kit de união		932100
• União galvanizada, parafusos incluídos.		
Cabo de segurança em aço		955000
L1500 mm		
Versão Low Output		
• Sob consulta.		
Projetos à medida		
• Sob consulta.		



*Substitua os símbolos para completar o código

Cor	Ícone
□ Branco	W
■ Cinzento	G
■ Preto	B



Detalhes do produto



Perfil exterior



Nivelador



Aplicação de encastrar

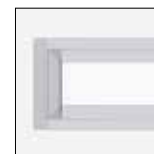

Difusor bFLEX

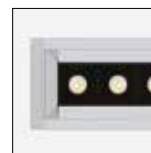

Difusor bOPTICS



Spot orientável



Acabamento em branco



Acabamento em preto



Acabamento em cinzento



Acabamento em branco/preto



Acabamento em preto/preto



Acabamento em preto/golden eye



Start Kit





REBA 50 bOPTICS



Características do produto

Corpo

Perfil de alumínio extrudido

Acabamento

Revestido a epóxi-poliéster

Sistema ótico

bFLEX - Difusor opalino

bOPTICS - Refletor simétrico

PB - Refletor brilhante

Fonte de luz

Perfil interior: LED, RG1, CRI>80,

MacAdam Step ≤3

Spot: LED, RG1, CRI>90, MacAdam Step ≤3

Vida útil LED

Perfil interior: 80.000h @ L90, B10, Ta 25°C

Spot: 86.000h @ L80, B10, Ta 25°C

Fonte de alimentação

Driver LED 220-240V-50/60Hz incluído



230V/50Hz

IP 20

bOPTICS
650°C

PB
850°C

bFLEX
960°C

01. Selecionar perfil exterior

PERFIL EXTERIOR

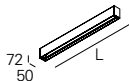

Lmm	CÓDIGO*
663	90737L0020▲0000
981	90737L0030▲0000
1299	90737L0040▲0000
1617	90737L0050▲0000
1936	90737L0060▲0000
2254	90737L0070▲0000
2573	90737L0080▲0000
2891	90737L0090▲0000



*Substitua os símbolos para completar o código

Cor	▲
□ Branco	W
■ Cinzento	G
■ Preto	B

PERFIL EXTERIOR

- Para completar o produto é necessário encomendar o perfil interior em separado.
- Para versão suspensa é necessário encomendar suspensão, cabo e caixa de alimentação em separado.

02. Selecionar interior

PERFIL INTERIOR

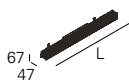

bOPTICS - Refletor simétrico 48°

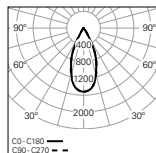

UGR	W	lm output	lm/W	Lmm	CÓDIGO*
≤10	12	1488	124	637	90747L002▼▲0♦00
≤10	18	2233	124	955	90747L003▼▲0♦00
≤10	24	2977	124	1273	90747L004▼▲0♦00
≤10	30	3721	124	1591	90747L005▼▲0♦00
≤10	34	4465	131	1910	90747L006▼▲0♦00
≤10	39	5209	134	2228	90747L007▼▲0♦00
≤10	45	5953	132	2547	90747L008▼▲0♦00
≤10	50	6698	134	2865	90747L009▼▲0♦00

*Substitua os símbolos para completar o código

Fonte de alimentação	▼
HF	E
DALI	H

Cor	▲
□ Branco	W
■ Cinzento	G
■ Preto	B

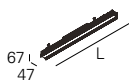

bFLEX - Difusor opalino

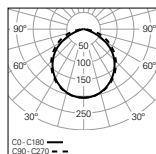

UGR	W	lm output	lm/W	Lmm	CÓDIGO*
≤25	12	1017	85	637	90748L002▼▲0♦00
≤25	18	1526	85	955	90748L003▼▲0♦00
≤25	24	2035	85	1273	90748L004▼▲0♦00
≤25	30	2543	85	1591	90748L005▼▲0♦00
≤25	34	3052	90	1910	90748L006▼▲0♦00
≤25	39	3561	91	2228	90748L007▼▲0♦00
≤25	45	4069	90	2547	90748L008▼▲0♦00
≤25	50	4578	92	2865	90748L009▼▲0♦00

Emergência	●
No EM	0
EM 3h (K3) ¹	3

Temp. de Cor	♦
3000K	3
4000K	0

¹ Preparado para telecomando.

02. Selecionar interior

SPOT - Projektor

Spot 1



Spot 2



Spot 3



PB - Refletor brilhante 20°

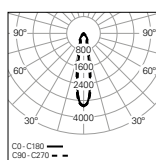

SPOT	W	lm output	lm/W	Lmm	CÓDIGO*
1	11	1168	106	318	90749L001E♣0♣♠2
1	11	1168	106	637	90749L002♥♣0♣♠2
2	21	2336	111	318	90750L001E♣0♣♠2
2	21	2336	111	637	90750L002♥♣0♣♠2
3	30	3504	117	637	90751L002♥♣0♣♠2

PB - Refletor brilhante 50°

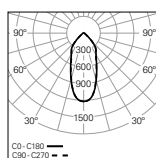

SPOT	W	lm output	lm/W	Lmm	CÓDIGO*
1	11	1144	104	318	90749L001E♣0♣♠5
1	11	1144	104	637	90749L002♥♣0♣♠5
2	21	2288	109	318	90750L001E♣0♣♠5
2	21	2288	109	637	90750L002♥♣0♣♠5
3	30	3431	114	637	90751L002♥♣0♣♠5



*Substitua os símbolos para completar o código

Fonte de alimentação	
HF	E
DALI	H



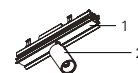





Cor	
□ Branco	W/W
■ Preto	B/B
■ Cinzento	G/G
□ Branco/Preto	W/B
■ Preto/Branco	B/W
■ Preto/Golden eye	B/D



Legenda:
1. Corpo
2. Spot

Temp. de Cor	
3000K	B
4000K	A

03. Selecionar opções

OPÇÕES	Código*
Suspensão	
S5 L1500 mm (x1)	910408
S5 L1500 mm (x2)	910409
S5 L3000 mm (x1)	910419
S5 L3000 mm (x2)	910412
S5 L6000 mm (x1)	910420
S5 L6000 mm (x2)	910421
Cabo de alimentação transparente	
L1500 mm - 3 x 0,75 mm ²	940400
L1500 mm - 5 x 0,75 mm ²	940500
L1500 mm - 7 x 0,75 mm ²	940600
L3000 mm - 3 x 0,75 mm ²	940401
L3000 mm - 5 x 0,75 mm ²	940501
L3000 mm - 7 x 0,75 mm ²	940601
L6000 mm - 3 x 0,75 mm ²	940402
L6000 mm - 5 x 0,75 mm ²	940507
L6000 mm - 7 x 0,75 mm ²	940602
• Para a versão DALI com kit de emergência e telecomando é necessário encomendar 2 cabos de alimentação 5 x 0,75 mm ² .	
Caixa de alimentação quadrada	
Saliente T25  45  100	978610▲
Saliente T29 (DALI+K3)	978611▲
Encastrar T7  Ø70 35  90	971400▲
Encastrar T59 (DALI+K3)	971410▲
Caixa de alimentação circular	
Saliente T24  45  Ø95	978600▲
Saliente T26 (DALI+K3)	978601▲
Encastrar T5  Ø70 33  Ø90	971300▲
Encastrar T27 (DALI+K3)	978700▲
Versão Low Output	
• Sob consulta.	



*Substitua os símbolos para completar o código

Cor

<input type="checkbox"/> Branco	W
<input type="checkbox"/> Preto	B



Detalhes do produto



Perfil exterior

Topos sem parafusos visíveis

Suspensão



Aplicação saliente

Aplicação suspensa

Difusor bFLEX



Difusor bOPTICS

Spot orientável

Acabamento em branco



Acabamento em preto

Acabamento em cinzento

Acabamento em branco/preto



Acabamento em preto/branco

Acabamento em preto/golden eye

Caixas de alimentação quadradas



Caixas de alimentação circulares

REBA 50 bOPTICS Line



Características do produto

Corpo

Perfil de alumínio extrudido

Acabamento

Revestido a epóxi-poliéster

Sistema ótico

bFLEX - Difusor opalino

bOPTICS - Refletor simétrico

PB - Refletor brilhante

Fonte de luz

Perfil interior: LED, RG1, CRI>80,

MacAdam Step ≤ 3

Spot: LED, RG1, CRI>90, MacAdam Step ≤ 3

Vida útil LED

Perfil interior: 80.000 @ L90, B10, Ta 25°C

Spot: 86.000h @ L80, B10, Ta 25°C

Fonte de alimentação

Driver LED 220-240V-50/60Hz incluído

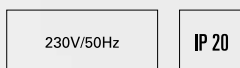

01. Selecionar perfil exterior



PERFIL EXTERIOR

Início / Fim (SRT/END)

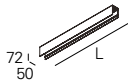

Lmm	CÓDIGO*
647	90738L0020▲0083
965	90738L0030▲0083
1283	90738L0040▲0083
1601	90738L0050▲0083
1920	90738L0060▲0083
2238	90738L0070▲0083
2557	90738L0080▲0083
2875	90738L0090▲0083

*Substitua os símbolos para completar o código

Cor	▲
□ Branco	W
■ Cinzento	G
■ Preto	B

Intermédio (MID)

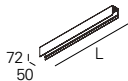

Lmm	CÓDIGO*
637	90738L0020▲0000
955	90738L0030▲0000
1273	90738L0040▲0000
1591	90738L0050▲0000
1910	90738L0060▲0000
2228	90738L0070▲0000
2547	90738L0080▲0000
2865	90738L0090▲0000

PERFIL EXTERIOR

- Para completar o produto é necessário encomendar o perfil interior em separado.
- Para versão suspensa é necessário encomendar suspensão, cabo e caixa de alimentação em separado.
- Para completar a linha é necessário encomendar start kit, cablagem de linha contínua e kit de união em separado.
- As dimensões não incluem start kit. Adicione 6 mm ao comprimento para completar a linha.
- O comprimento máximo da linha com um único ponto de alimentação é 30000 mm.

02. Selecionar interior



PERFIL INTERIOR

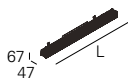

bOPTICS - Refletor simétrico 48°

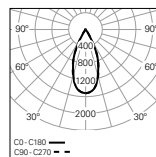

UGR	W	lm output	lm/W	Lmm	CÓDIGO*
≤10	12	1488	124	637	90747L002▼▲0♦00
≤10	18	2233	124	955	90747L003▼▲0♦00
≤10	24	2977	124	1273	90747L004▼▲0♦00
≤10	30	3721	124	1591	90747L005▼▲0♦00
≤10	34	4465	131	1910	90858L006▼▲0♦00
≤10	39	5209	134	2228	90858L007▼▲0♦00
≤10	45	5953	132	2547	90858L008▼▲0♦00
≤10	50	6698	134	2865	90858L009▼▲0♦00

*Substitua os símbolos para completar o código

Fonte de alimentação	▼
HF	E
DALI	H

Cor	▲
□ Branco	W
■ Cinzento	G
■ Preto	B

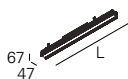

bFLEX - Difusor opalino

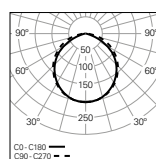

UGR	W	lm output	lm/W	Lmm	CÓDIGO*
≤25	12	1017	85	637	90748L002▼▲0♦00
≤25	18	1526	85	955	90748L003▼▲0♦00
≤25	24	2035	85	1273	90748L004▼▲0♦00
≤25	30	2543	85	1591	90748L005▼▲0♦00
≤25	34	3052	90	1910	90859L006▼▲0♦00
≤25	39	3561	91	2228	90859L007▼▲0♦00
≤25	45	4069	90	2547	90859L008▼▲0♦00
≤25	50	4578	92	2865	90859L009▼▲0♦00

Emergência	●
No EM	0
EM 3h (K3) ¹	3

Temp. de Cor	♦
3000K	3
4000K	0

¹ Preparado para telecomando.

02. Selecionar interior

SPOT - Projetor

Spot 1



Spot 2



Spot 3



PB - Refletor brilhante 20°

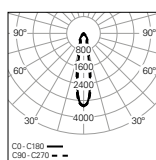

SPOT	W	lm output	lm/W	Lmm	CÓDIGO*
1	11	1168	106	318	90749L001E♣0♣♠2
1	11	1168	106	637	90749L002♥♣0♣♠2
2	21	2336	111	318	90750L001E♣0♣♠2
2	21	2336	111	637	90750L002♥♣0♣♠2
3	30	3504	117	637	90751L002♥♣0♣♠2

PB - Refletor brilhante 50°

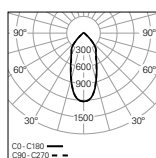

SPOT	W	lm output	lm/W	Lmm	CÓDIGO*
1	11	1144	104	318	90749L001E♣0♣♠5
1	11	1144	104	637	90749L002♥♣0♣♠5
2	21	2288	109	318	90750L001E♣0♣♠5
2	21	2288	109	637	90750L002♥♣0♣♠5
3	30	3431	114	637	90751L002♥♣0♣♠5

SPOT - Projetor

- A versão SPOT L318 mm apenas pode ser aplicado no fim de linha (END).



*Substitua os símbolos para completar o código

Fonte de alimentação
HF E
DALI H

Cor
□ Branco W/W
■ Preto B/B
■ Cinzento G/G
□ Branco/Preto W/B
■ Preto/Branco B/W
■ Preto/Golden eye B/D



Legenda:
1. Corpo
2. Spot

Temp. de Cor
3000K B
4000K A



*Substitua os símbolos para completar o código



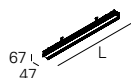

Cor
□ Branco W
■ Cinzento G
■ Preto B

MÓDULO CEGO



Lmm	CÓDIGO*
318	90744L0010♣0000
637	90744L0020♣0000
955	90744L0030♣0000
1273	90744L0040♣0000
1591	90744L0050♣0000
1910	90744L0060♣0000
2228	90744L0070♣0000
2547	90744L0080♣0000
2865	90744L0090♣0000

03. Selecionar opções

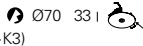
OPÇÕES		Código*
Start kit - topo início/fim		923110▲
• Dois topos incluídos.		
Cablagem linha contínua		
• Standard		
3 x 1,5 mm ²		945650
5 x 1,5 mm ²		945750
• 2 x 1,5 mm²		
HF+K3 (x1) - L638 - L1914 mm		948000
HF+K3 (x2) - L2233 - L2871 mm		948001
• 2 x 1,5 mm² + Junção 5P		
DALI+K3 (x1) - L638 - L1914 mm		948200
DALI+K3 (x2) - L2233 - L2871 mm		948201
• 2 x 1,5 mm² + 2 x 0,75 mm² + Junção 5P		
K3+TEL (x1) - L638 - L1914 mm		948100
K3+TEL (x2) - L2233 - L2871 mm		948101
Kit de união		932100
• União galvanizada, parafusos incluídos.		
Suspensão		
S5 L1500 mm (x1)		910408
S5 L1500 mm (x2)		910409
S5 L3000 mm (x1)		910419
S5 L3000 mm (x2)		910412
S5 L6000 mm (x1)		910420
S5 L6000 mm (x2)		910421
Cabo de alimentação transparente		
3 x 1,5 mm ²		94030▲
5 x 1,5 mm ²		94000▲
7 x 1,5 mm ²		94010▲
• Para a versão DALI com kit de emergência e telecomando é necessário encomendar 2 cabos de alimentação 5 x 1,5 mm ² .		
Caixa de alimentação quadrada³		
Saliente T25		978610▲
Saliente T29 (DALI+K3)		978611▲
Encastrar T7		971400▲
Encastrar T59 (DALI+K3)		971410▲
Caixa de alimentação circular³		
Saliente T24		978600▲
Saliente T26 (DALI+K3)		978601▲
Encastrar T5		971300▲
Encastrar T27 (DALI+K3)		978700▲
Versão Low Output		
• Sob consulta.		
Projetos à medida		
• Sob consulta.		



*Substitua os símbolos para completar o código

Comprimento	▲
L1500 mm	0
L3000 mm	1
L6000 mm	2

Cor ³	▲
<input type="checkbox"/> Branco	W
<input type="checkbox"/> Cinzento	G
<input type="checkbox"/> Preto	B



Detalhes do produto



³ As caixas de alimentação apenas estão disponíveis na cor branca ou preta.







Sistemas e perfis
de alumínio

REBA



REBA 50 /T
512



REBA 50 /T Line
516



REBA 50 /E
522



REBA 50 /E Line
526



REBA 50
532



REBA 50 Line
536



REBA 50 HEXA
546



REBA 50 D/I
550



REBA 50 D/I Line
554



REBA 50 /W
560



REBA 50 /W Line
564



REBA 65 /T
574



REBA 65 /T Line
578



REBA 65 /E
584



REBA 65 /E Line
588



REBA 65
594



REBA 65 Line
598



REBA 65 D/I
604



REBA 65 D/I Line
608



Tipos de aplicação

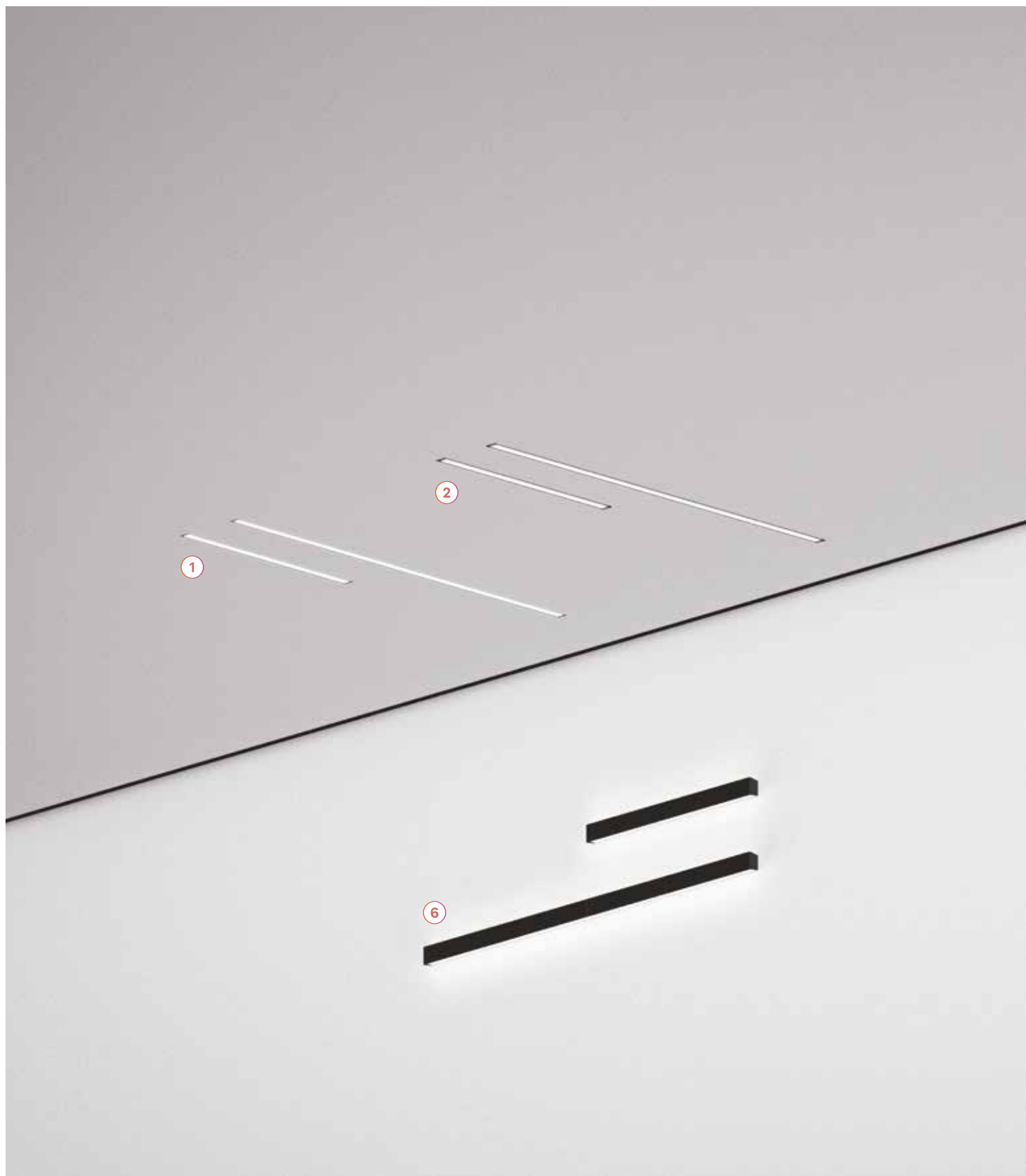

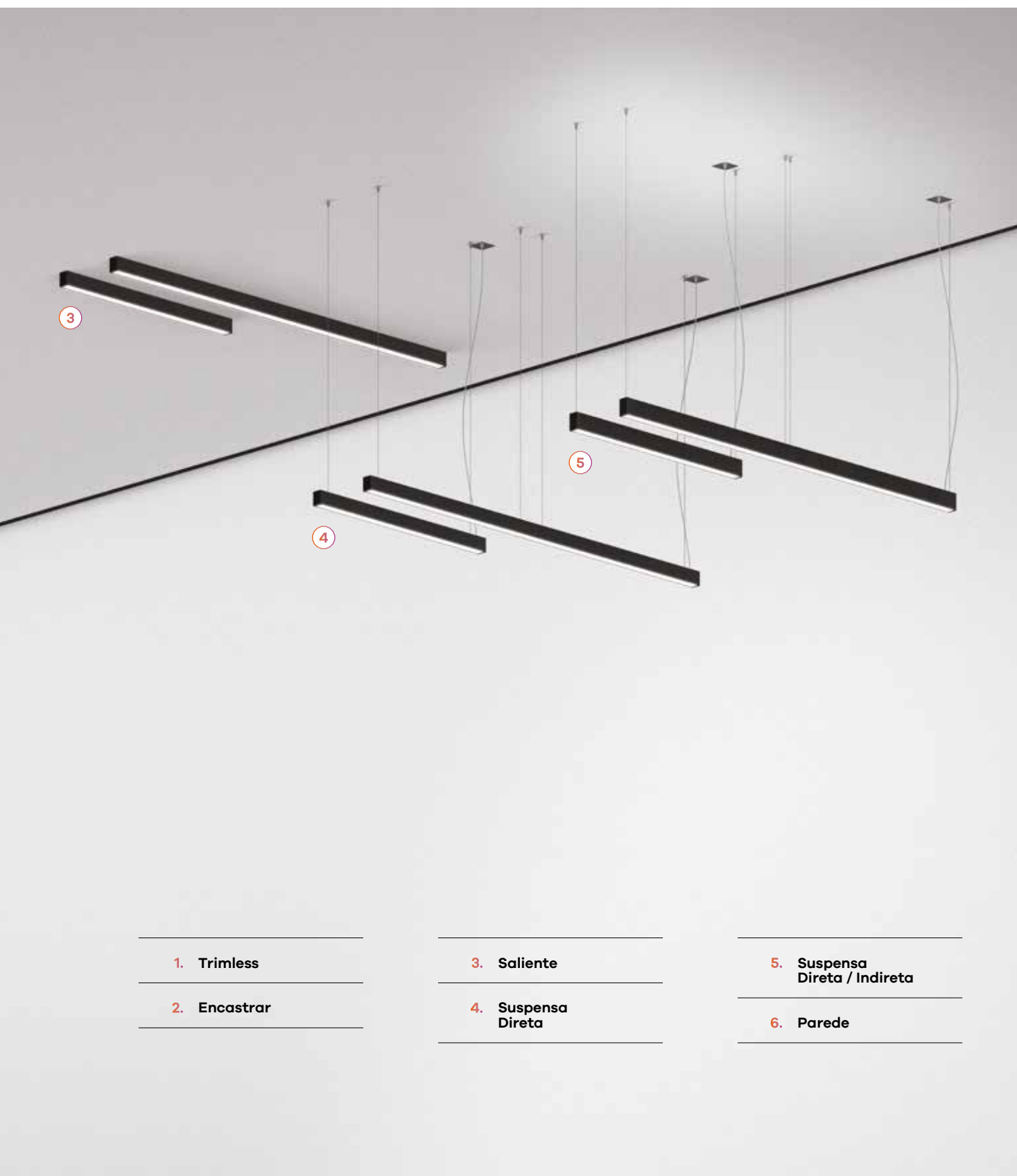

3

4

5

1. Trimless

2. Encastrar

3. Saliente

4. Suspensa
Direta

5. Suspensa
Direta / Indireta

6. Parede

Sistema ótico

1. bGLARE

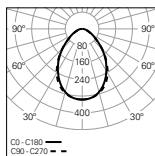

2. bLINE

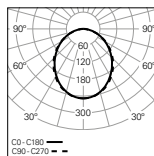

3. ASYM

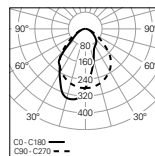

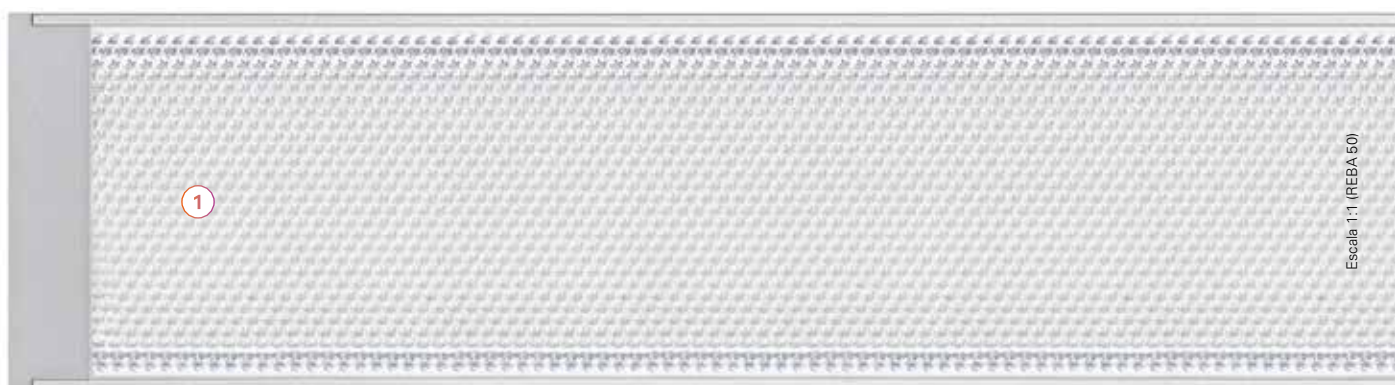

Uma gama de infinitas possibilidades





Linear

≈560 mm	•	•	•		
≈840 mm	•	•	•		
≈1120 mm	•	•	•	•	•
≈1400 mm	•	•	•	•	•
≈1680 mm	•	•	•	•	•
≈1960 mm	•	•	•	•	•
≈2240 mm	•	•	•	•	•
≈2520 mm	•	•	•	•	•
≈2800 mm	•	•	•	•	•

Canto com luz

≈600x600 mm	•	•	•	•	•
-------------	---	---	---	---	---

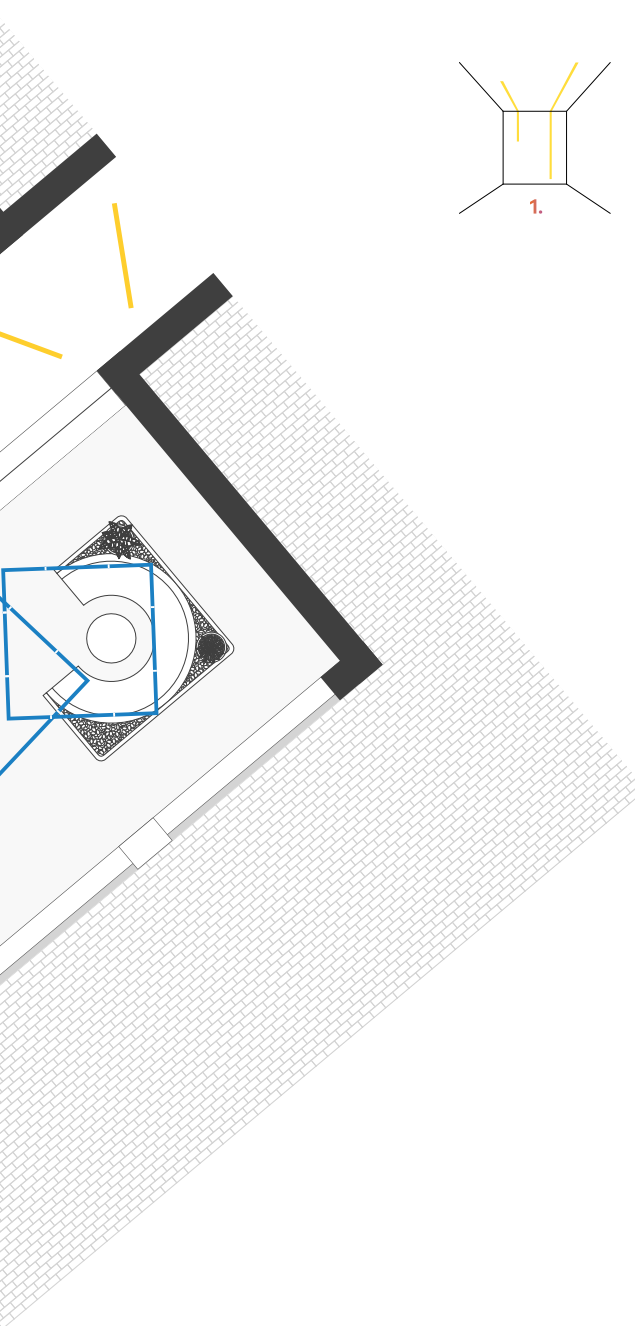
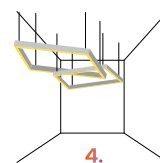
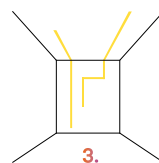
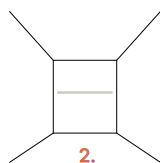
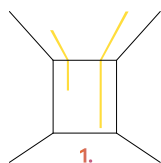

Módulos disponíveis

REBA 50



REBA 50 HEXA



REBA 65



Canto com luz

Linear

Escala 1000 mm
1:100



Architects: Gloone
Photo: Antonio Chaves



Architects: Gloone
Photo: António Chaves

Minimalismo e tecnologia

1. Perfil exterior

Perfil de alumínio extrudido, disponível em 3 cores.

2. LED

SDCM MacAdam ≤ 3 , temperatura de cor 3000K / 4000K, CRI > 80 e vida útil de 80.000h L90 B10.

3. Tunable White

Versões Tunable White disponíveis com um espectro de branco de 2700K até 6500K.



4. bGLARE, bLINE ou ASYM

Sistema ótico clip-in de alta tecnologia com difusor bGLARE microprísmático para uma iluminação de elevado conforto visual, difusor opalino bLINE para conceder uma luz suave, uniforme e sem pontos visíveis ou difusor ASYM para aplicações wall washer.

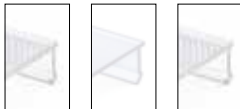

5. Eficiência acima de 100 lm/W

A gama REBA oferece uma elevada eficiência, com valores acima de 100 lm/W.

6. Topos

Topos sem parafusos visíveis e sem saída de luz. Disponíveis na cor do produto.

7. Perfil interior

Refletor interno em perfil de alto desempenho, revestido a epóxi-poliéster branco para garantir alta eficiência, luz suave e uniforme. Disponível nas versões simétrica ou assimétrica (wall washer) com distribuição de luz direta ou indireta. Também disponível na versão de parede, com opção de luz direta, indireta ou direta / indireta.



8. Versão direta / indireta

Versão direta / indireta com difusor opalino na parte superior, garantindo uma uniformidade da luz no teto perfeita.



9. Fonte de alimentação DALI ou HF

10. Suspensão e cabo de alimentação

Suspensão e cabo de alimentação disponíveis com comprimento de 1500, 3000 ou 6000 mm.



11. Caixa de alimentação

Caixas de alimentação nas versões de encastrar ou saliente disponíveis na cor branca ou preta.

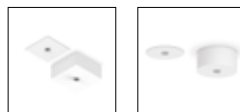

12. Kit de união

Os dois perfis são perfeitamente conectados para que não haja saída de luz em qualquer aplicação de linha contínua.

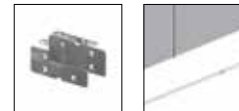

13. Kit de emergência

Kit de emergência de 3 horas. Disponível desde ≈ 1120 até ≈ 2800 mm.

14. Circuito duplo

Circuito duplo que permite controlar a luz direta / indireta em separado. Disponível como opção.

15. Pré-aro de montagem trimless

As versões trimless são fáceis de montar em tetos com 10, 13, 15 ou 18 mm de espessura. Pré-aro trimless fornecido com "kit de alinhamento de estrutura". Este acessório permite ao instalador manter a largura necessária em todo o comprimento da linha, garantindo uma instalação perfeita.

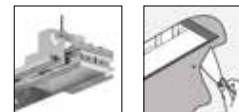

16. Nivelador

As versões de encastrar com aba têm instalação fácil garantida devido a um suporte de montagem inteligente para instalação em tetos / paredes de até 25 mm de espessura.



17. Cantos com luz

A gama REBA tem disponíveis 5 versões de cantos com luz.

- 17.1 Canto vertical
- 17.2 Canto horizontal
- 17.3 Canto horizontal de parede
- 17.4 Esquina horizontal de parede
- 17.5 Canto vertical de parede

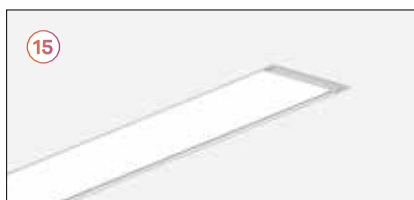
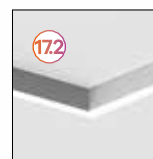
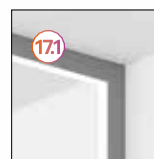
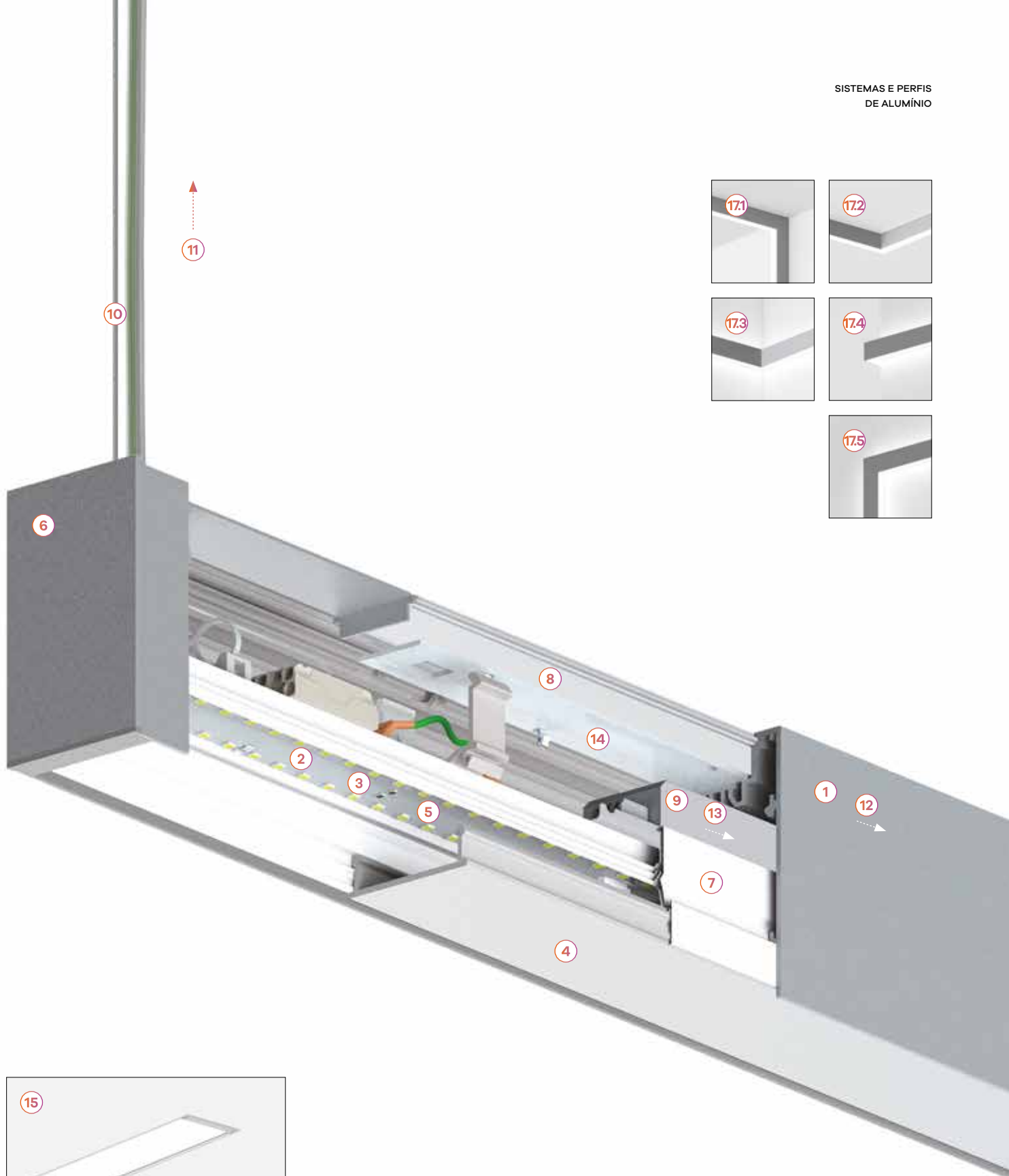

Composição de elementos estruturais

1. Topos

2. Perfil exterior

- 2.1 Módulo início / fim (SRT/END).
- 2.2 Módulo intermédio (MID) ou canto com luz (HRZ, VRT, EDGE).

3. Perfil interior

- 3.1 Simétrico
- 3.2 Assimétrico
- As duas versões de perfis interiores podem ser combinadas no mesmo perfil exterior.

4. Difusores

- 4.1 Difusor bGLARE
- 4.2 Difusor bLINE
- 4.3 Difusor ASYM
- 4.4 Módulo Cego

5. Kit de união

6. Caixas de alimentação

7. Cabo de alimentação

8. Suspensão

Módulos disponíveis

(Vista de cima)

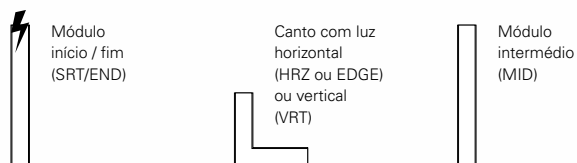

Como estruturar uma linha

(Vista de cima)

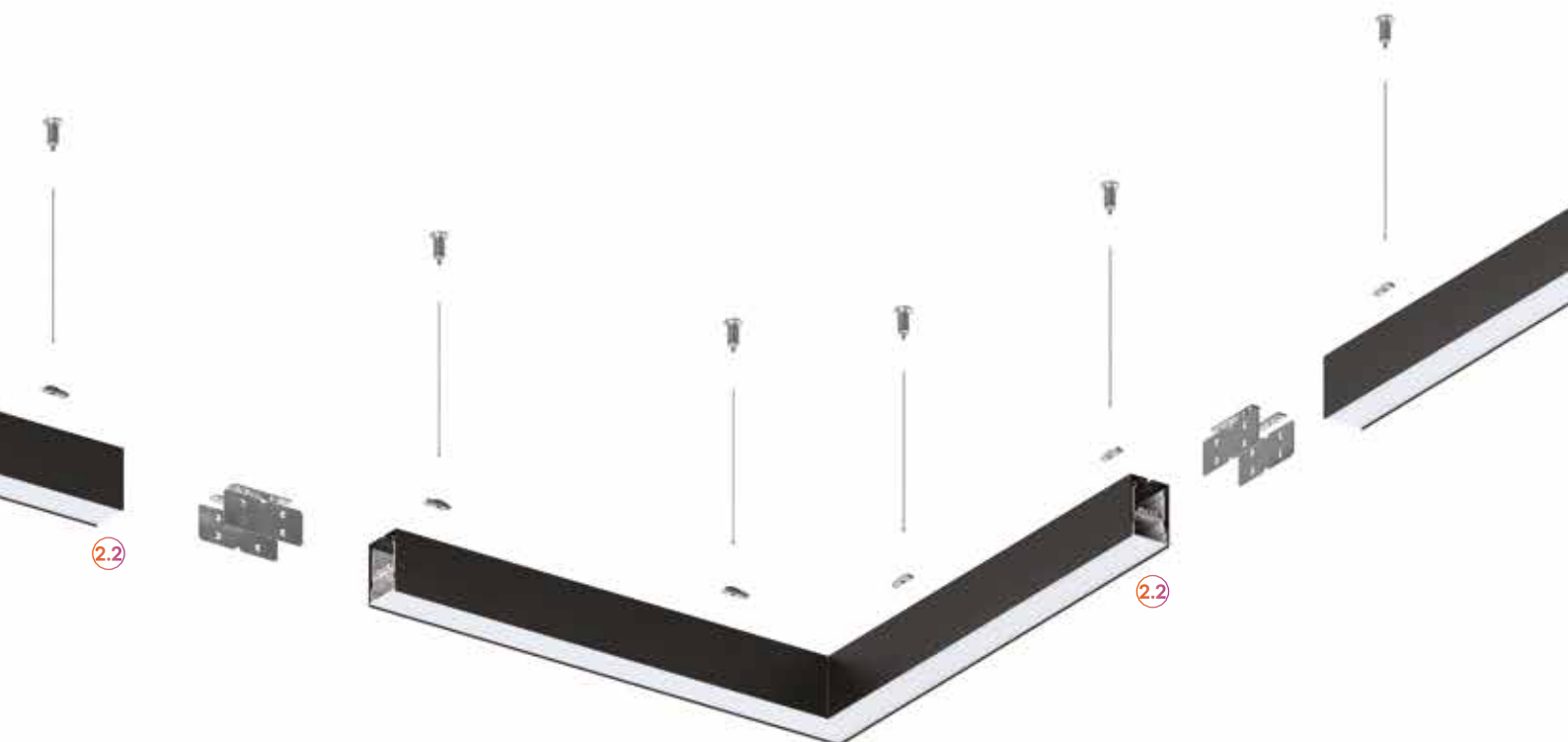
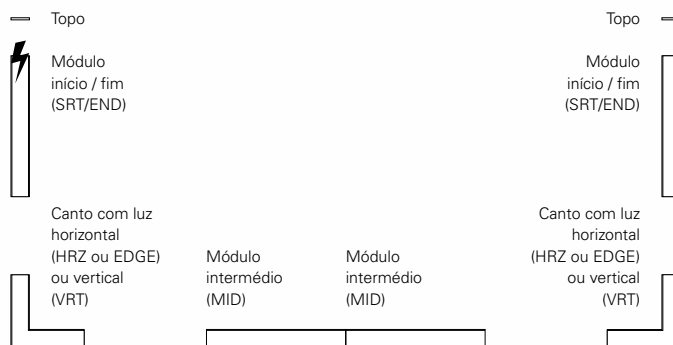

Esquema elétrico (K3)

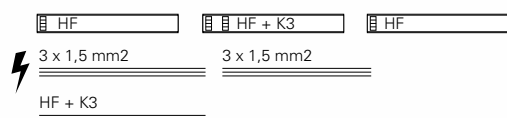

Esquema elétrico (K3 + Telecomando)

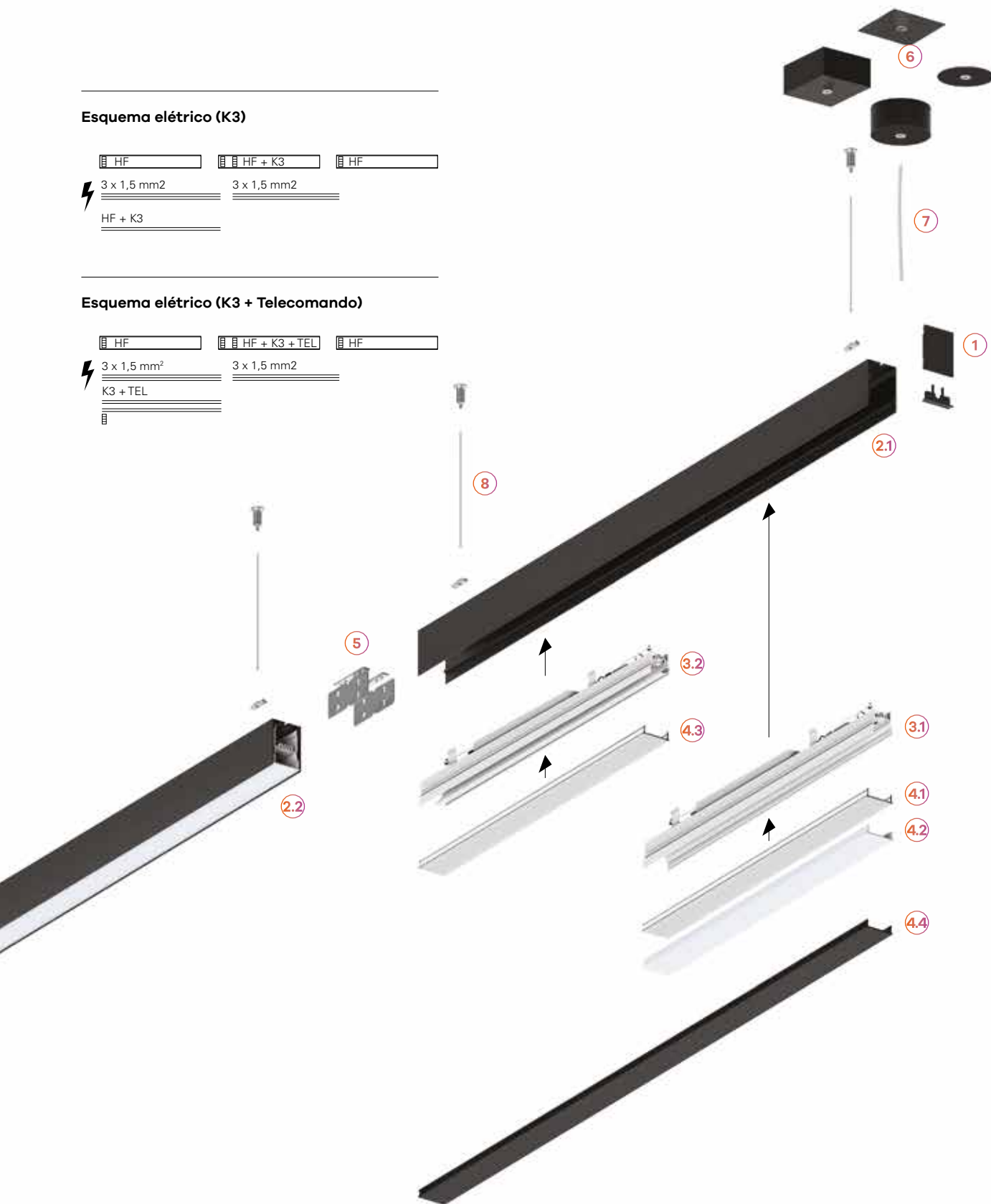
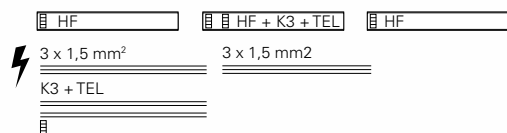

Defina a sua cor

SISTEMAS E PERFIS
DE ALUMÍNIO



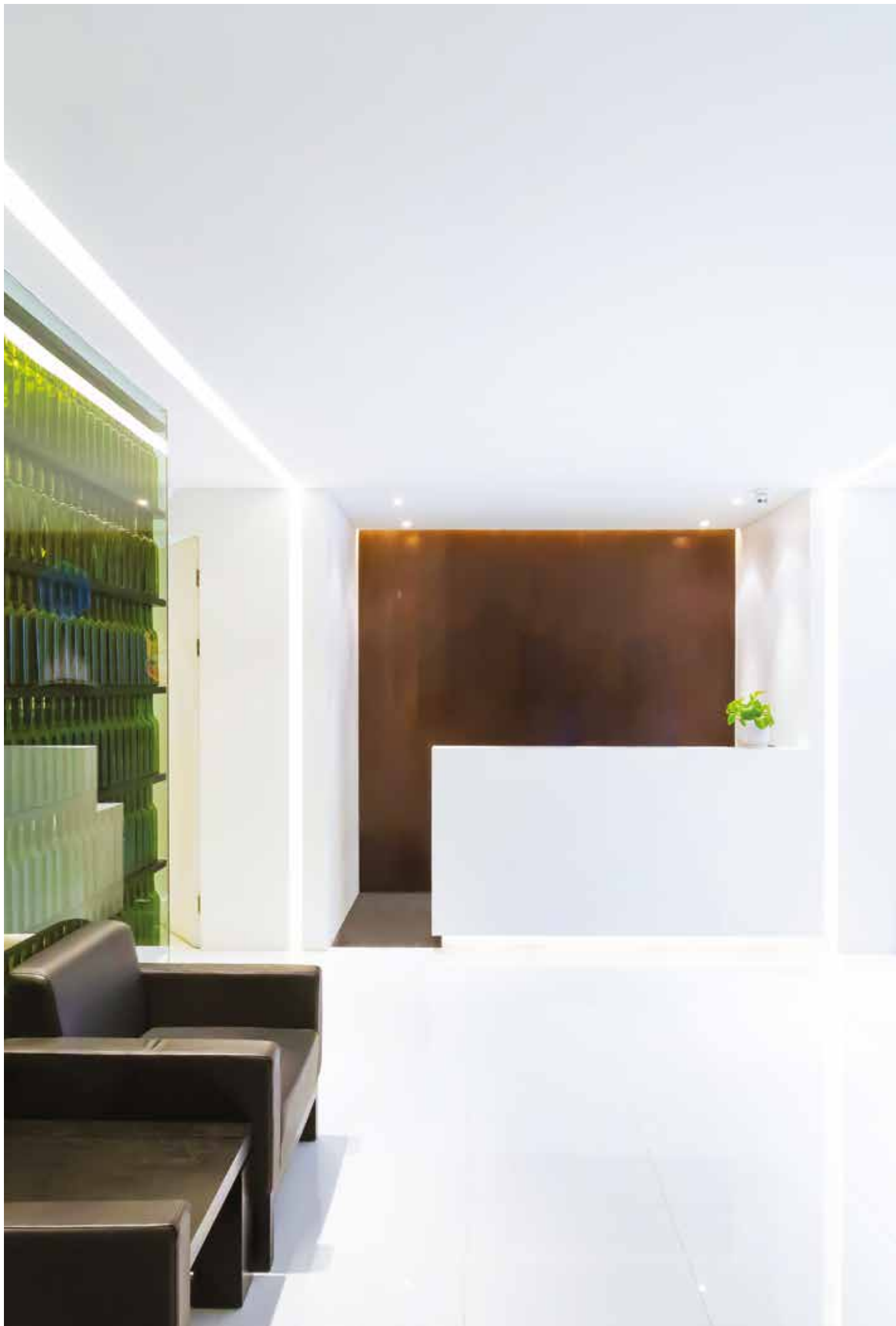

REBA 50

Como funciona

1. Perfil exterior

- 1.1 Encastrar
- 1.2 Trimless
- 1.3 Saliente
- 1.4 Suspensa direta
- 1.5 Suspensa direta / indireta
- 1.6 Parede

2. Perfil interior

- 2.1 Simétrico



- 2.2 Assimétrico



- 2.3 Parede



3. Difusores

- 3.1 Difusor bLINE
 - 3.2 Difusor bGLARE
 - 3.3 Tampa cega
 - 3.4 Difusor ASYM
-



54x90 mm

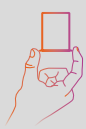

62x72 mm



50x72 mm



50x87 mm

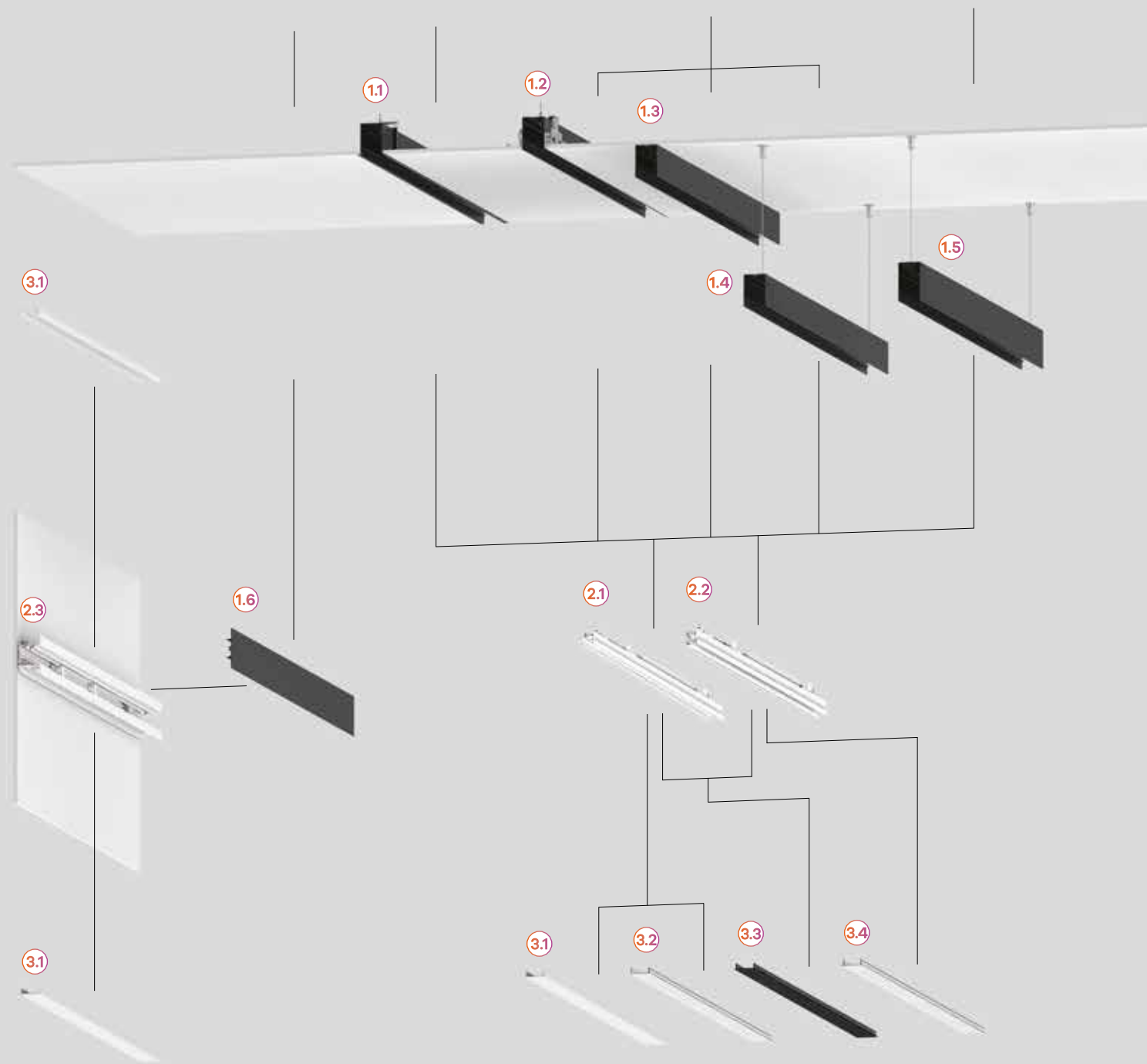

REBA 50 /T



Características do produto

Corpo

Perfil de alumínio extrudido

Acabamento

Revestido a epóxi-poliéster

Sistema de fixação

Pré-aro trimless (incluído no perfil exterior)

Sistema ótico

bGLARE - Difusor microprismático

bLINE - Difusor opalino

ASYM - Difusor assimétrico

Fonte de luz

LED, RG1, CRI>80, MacAdam Step ≤3

Vida útil LED

80.000h @ L90, B10, Ta 25°C

Fonte de alimentação

Driver LED 220-240V-50/60Hz incluído

Espessura do teto

Para tetos de 10, 13, 15 e 18 mm

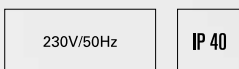

01. Seleccionar perfil exterior

PERFIL EXTERIOR

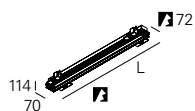

Lmm		CÓDIGO*
598	600	90519L0020▲0000
878	880	90519L0030▲0000
1158	1160	90519L0040▲0000
1438	1440	90519L0050▲0000
1718	1720	90519L0060▲0000
2000	2002	90519L0070▲0000
2280	2282	90519L0080▲0000
2560	2562	90519L0090▲0000
2840	2842	90519L0100▲0000



*Substitua os símbolos para completar o código

Cor	▲
<input type="checkbox"/> Branco	W
<input type="checkbox"/> Cinzento	G
<input type="checkbox"/> Preto	B

PERFIL EXTERIOR

• Para completar o produto é necessário encomendar o perfil interior em separado.

02. Seleccionar perfil interior e difusor

PERFIL INTERIOR | SIMÉTRICO

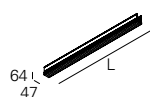

bGLARE - Difusor microprismático

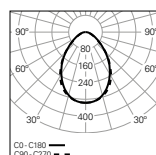

W	lm output	lm/W	Lmm	CÓDIGO*
15	1603	107	562	90498L002▼W0◆00
22	2405	109	842	90498L003▼W0◆00
30	3207	107	1122	90498L004▼W0◆00
35	4008	115	1402	90498L005▼W0◆00
42	4810	115	1682	90498L006▼W0◆00
52	5612	108	1964	90498L007▼W0◆00
60	6413	107	2244	90498L008▼W0◆00
65	7215	111	2524	90498L009▼W0◆00
70	8017	115	2804	90498L010▼W0◆00

bLINE - Difusor opalino

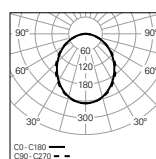

W	lm output	lm/W	Lmm	CÓDIGO*
15	1655	110	562	90497L002▼W0◆00
22	2483	113	842	90497L003▼W0◆00
30	3310	110	1122	90497L004▼W0◆00
35	4138	118	1402	90497L005▼W0◆00
42	4965	118	1682	90497L006▼W0◆00
52	5793	111	1964	90497L007▼W0◆00
60	6620	110	2244	90497L008▼W0◆00
65	7448	115	2524	90497L009▼W0◆00
70	8275	118	2804	90497L010▼W0◆00

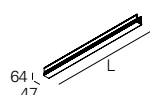

*Substitua os símbolos para completar o código

Fonte de alimentação	▼
HF	E
DALI	H

Emergência	●
No EM	0
EM 3h (K3) ^{1 2}	3

Temp. de Cor	◆
3000K	3
4000K	0
Tunable White ³	T

PERFIL INTERIOR | ASSIMÉTRICO

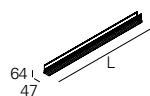

ASYM - Difusor

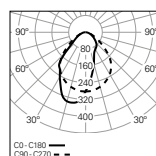

W	lm output	lm/W	Lmm	CÓDIGO*
16	1396	87	562	90500L002▼W0◆00
23	2095	91	842	90500L003▼W0◆00
29	2793	96	1122	90500L004▼W0◆00
36	3491	97	1402	90500L005▼W0◆00
44	4189	95	1682	90500L006▼W0◆00
52	4888	94	1964	90500L007▼W0◆00
58	5586	96	2244	90500L008▼W0◆00
65	6284	97	2524	90500L009▼W0◆00
73	6982	96	2804	90500L010▼W0◆00

¹ Preparado para telecomando.

² Versões DALI + EM 3h (K3) apenas disponível desde L1402 mm.

³ Apenas disponível nas versões DALI sem kit de emergência (No EM). Não disponível na versão L562 mm.

03. Selecionar opções

OPÇÕES	Código
SwitchDIM Tunable White • Para $L \leq 1682$ mm permite controlar no máximo 20 luminárias, $L \geq 1964$ mm permite controlar no máximo 10 luminárias por cada SwitchDIM Tunable White.	926600
Cabo de segurança em aço L1500 mm	955000
Versão Low Output • Sob consulta.	



Detalhes do produto



Perfil exterior



Perfil interior simétrico



Perfil interior assimétrico



Uniformidade de luz



Pré-aro trimless



Difusor clip-in

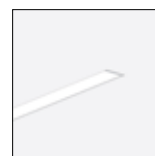

Aplicação trimless



Difusor bGLARE



Difusor bLINE



Difusor ASYM



SwitchDIM Tunable White



REBA 50 /T Line

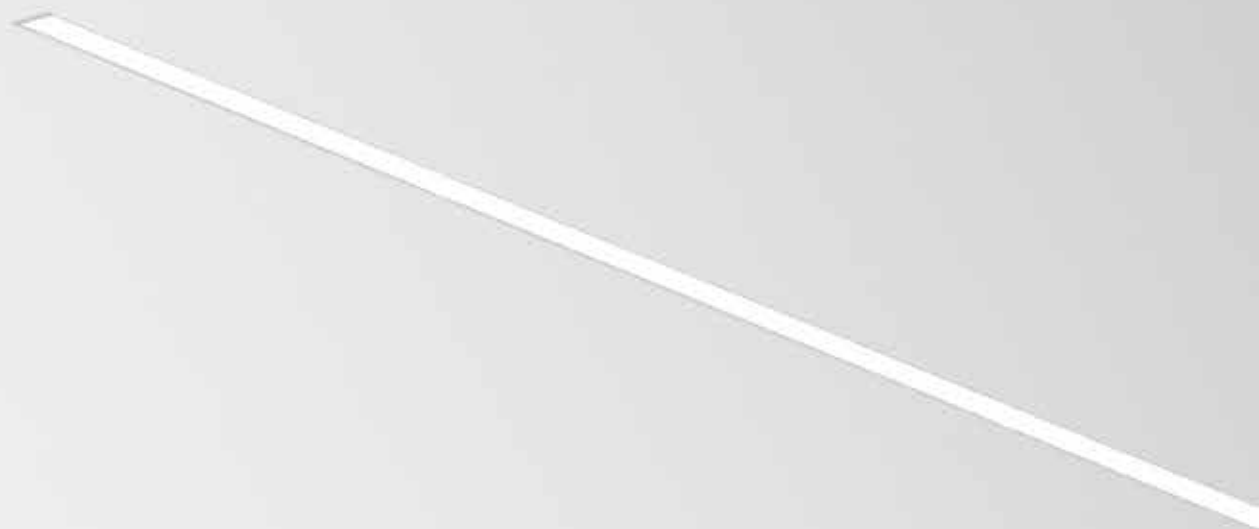

Características do produto

Corpo

Perfil de alumínio extrudido

Acabamento

Revestido a epóxi-poliéster

Sistema de fixação

Pré-aro trimless (incluído no perfil exterior)

Sistema ótico

bGLARE - Difusor microprismático

bLINE - Difusor opalino

ASYM - Difusor assimétrico

Fonte de luz

LED, RG1, CRI>80, MacAdam Step ≤ 3

Vida útil LED

80.000h @ L90, B10, Ta 25°C

Fonte de alimentação

Driver LED 220-240V-50/60Hz incluído

Espessura do teto

Para tetos de 10, 13, 15 e 18 mm

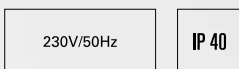
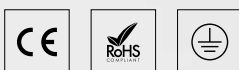

01. Selecionar perfil exterior



PERFIL EXTERIOR

Início / Fim (SRT/END)

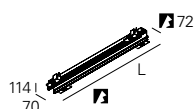

Lmm		CÓDIGO*
580	581	90507L0020▲0083
860	861	90507L0030▲0083
1140	1141	90507L0040▲0083
1420	1421	90507L0050▲0083
1700	1701	90507L0060▲0083
1982	1983	90507L0070▲0083
2262	2263	90507L0080▲0083
2542	2543	90507L0090▲0083
2822	2823	90507L0100▲0083

*Substitua os símbolos para completar o código

Cor	
<input type="checkbox"/> Branco	W
<input type="checkbox"/> Cinzento	G
<input type="checkbox"/> Preto	B

Intermédio (MID)

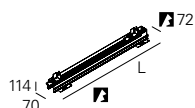

Lmm		CÓDIGO*
562	562	90507L0020▲0000
842	842	90507L0030▲0000
1122	1122	90507L0040▲0000
1402	1402	90507L0050▲0000
1682	1682	90507L0060▲0000
1964	1964	90507L0070▲0000
2244	2244	90507L0080▲0000
2524	2524	90507L0090▲0000
2804	2804	90507L0100▲0000

Canto vertical (VRT)

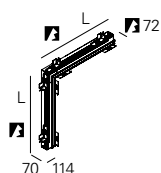

Lmm		CÓDIGO*
569	534	90507V0040▲0000

Canto horizontal (HRZ) - Esquina horizontal (EDGE)

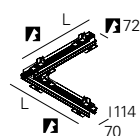

Lmm		CÓDIGO*
611	612	90507H0040▲0000

PERFIL EXTERIOR

- Para completar o produto é necessário encomendar o perfil interior em separado.
- Para completar a linha é necessário encomendar start kit, cablagem de linha contínua e kit de união em separado.
- O comprimento máximo da linha com um único ponto de alimentação é 30000 mm.

02. Selecionar perfil interior e difusor



PERFIL INTERIOR | SIMÉTRICO

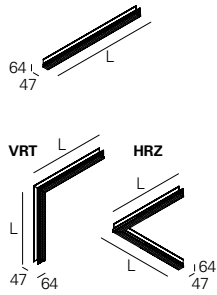

bGLARE - Difusor microprismático

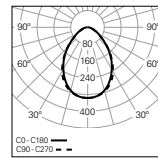

W	lm output	lm/W	Lmm	CÓDIGO*	
15	1603	107	562	90498L002♥VV0♦00	
22	2405	109	842	90498L003♥VV0♦00	
30	3207	107	1122	90498L004♥VV♦♦00	
35	4008	115	1402	90498L005♥VV♦♦00	
42	4810	115	1682	90498L006♥VV♦♦00	
52	5612	108	1964	90498L007♥VV♦♦00	
60	6413	107	2244	90498L008♥VV♦♦00	
65	7215	111	2524	90498L009♥VV♦♦00	
70	8017	115	2804	90498L010♥VV♦♦00	
VRT	30	3207	107	599	90498V004♥VV0♦00
HRZ	30	3207	107	577	90498H004♥VV0♦00

bLINE - Difusor opalino

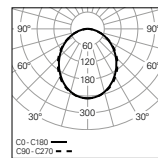

W	lm output	lm/W	Lmm	CÓDIGO*	
15	1655	110	562	90497L002♥VV0♦00	
22	2483	113	842	90497L003♥VV0♦00	
30	3310	110	1122	90497L004♥VV♦♦00	
35	4138	118	1402	90497L005♥VV♦♦00	
42	4965	118	1682	90497L006♥VV♦♦00	
52	5793	111	1964	90497L007♥VV♦♦00	
60	6620	110	2244	90497L008♥VV♦♦00	
65	7448	115	2524	90497L009♥VV♦♦00	
70	8275	118	2804	90497L010♥VV♦♦00	
VRT	30	3310	110	599	90497V004♥VV0♦00
HRZ	30	3310	110	577	90497H004♥VV0♦00

PERFIL INTERIOR | ASSIMÉTRICO

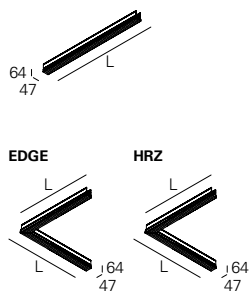

ASYM - Difusor

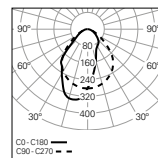

W	lm output	lm/W	Lmm	CÓDIGO*	
16	1396	87	562	90500L002♥VV0♦00	
23	2095	91	842	90500L003♥VV0♦00	
29	2793	96	1122	90500L004♥VV♦♦00	
36	3491	97	1402	90500L005♥VV♦♦00	
44	4189	95	1682	90500L006♥VV♦♦00	
52	4888	94	1964	90500L007♥VV♦♦00	
58	5586	96	2244	90500L008♥VV♦♦00	
65	6284	97	2524	90500L009♥VV♦♦00	
73	6982	96	2804	90500L010♥VV♦♦00	
EDGE	29	2793	96	599	90500E004♥VV0♦00
HRZ	29	2793	96	577	90500H004♥VV0♦00

*Substitua os símbolos para completar o código

Fonte de alimentação ♥
HF E
DALI H

Emergência ●
No EM 0
EM 3h (K3) ^{1 2} 3

Temp. de Cor ♦
3000K 3
4000K 0
Tunable White ³ T

¹ Preparado para telecomando.

² Versões DALI + EM 3h (K3) apenas disponível desde L1402 mm.

³ Apenas disponível nas versões DALI sem kit de emergência (No EM). Não disponível na versão L562 mm.

03. Selecionar opções

OPÇÕES	Código*
SwitchDIM Tunable White • Para L ≤ 1682 mm permite controlar no máximo 20 luminárias, L ≥ 1964 mm permite controlar no máximo 10 luminárias por cada SwitchDIM Tunable White.	926600
Start kit - topo início/fim • Dois topos incluídos.	72 50 3 923100♣
Cablagem linha contínua • Standard 3 x 1,5 mm ² 5 x 1,5 mm ²	945650 945750
• 2 x 1,5 mm² HF+K3 (x1) - L562 - L1682 mm HF+K3 (x2) - L1964 - L2804 mm	948000 948001
• 2 x 1,5 mm² + Junção 5P DALI+K3 (x1) - L562 - L1682 mm DALI+K3 (x2) - L1964 - L2804 mm	948200 948201
• 2 x 1,5 mm² + 2 x 0,75 mm² + Junção 5P K3+TEL (x1) - L562 - L1682 mm K3+TEL (x2) - L1964 - L2804 mm	948100 948101
Kit de união • União galvanizada, parafusos incluídos.	932130
Módulo cego L1500 mm L3000 mm • Inclui perfil interior e tampa de encaixe em alumínio.	992980♣ 992981♣
Cabo de segurança em aço L1500 mm	955000
Versão Low Output • Sob consulta.	
Projetos à medida • Sob consulta.	



*Substitua os símbolos para completar o código

Cor	♣
□ Branco	W
■ Cinzento	G
■ Preto	B



Detalhes do produto



Perfil exterior



Perfil interior simétrico



Perfil interior assimétrico



Uniformidade de luz

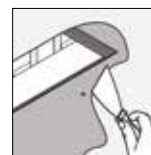

Pré-aro trimless



Difusor clip-in



Canto vertical



Canto horizontal

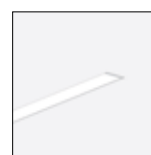

Aplicação trimless



Difusor bGLARE



Difusor bLINE



Difusor ASYM



SwitchDIM Tunable White



Start kit

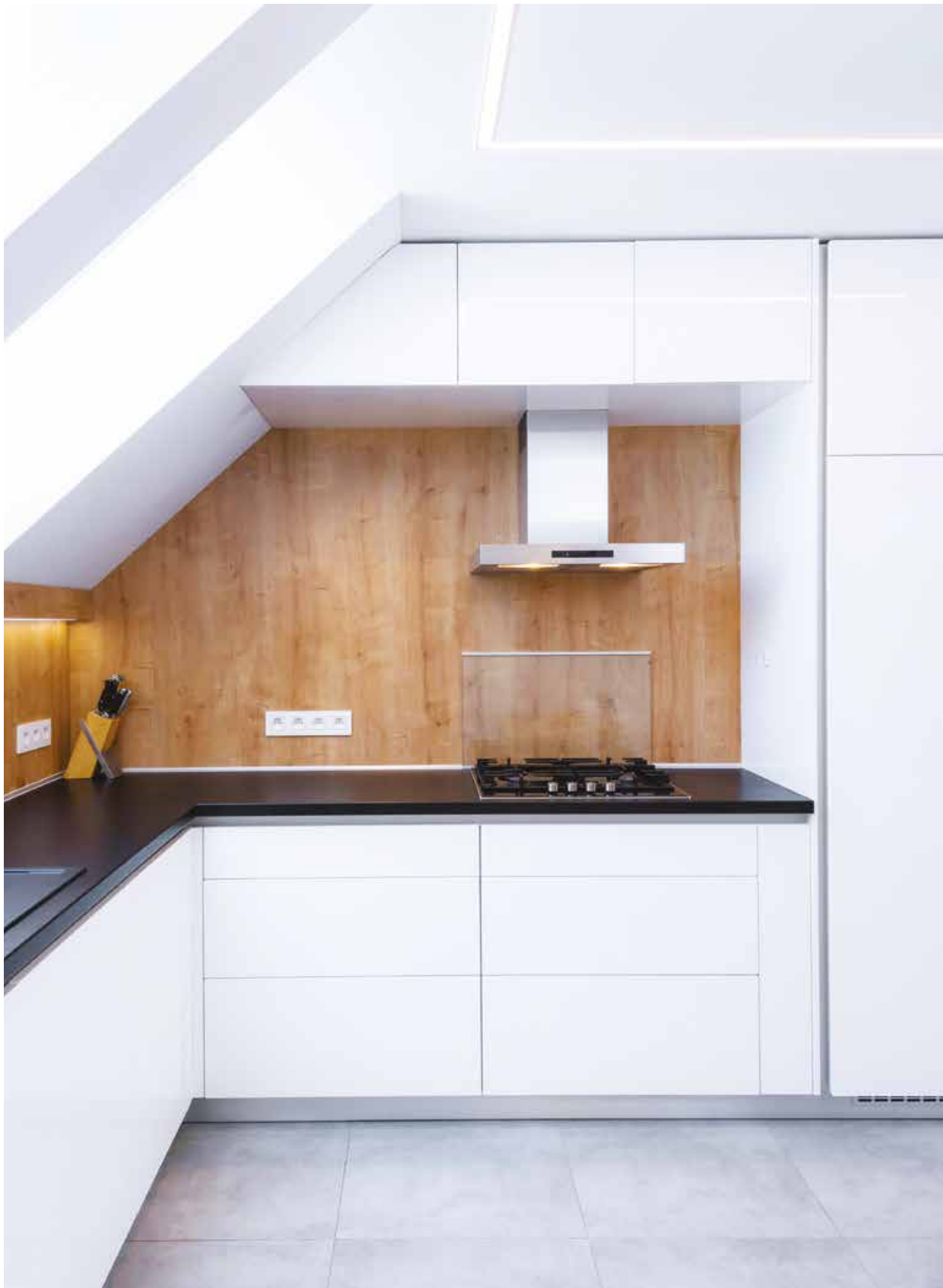

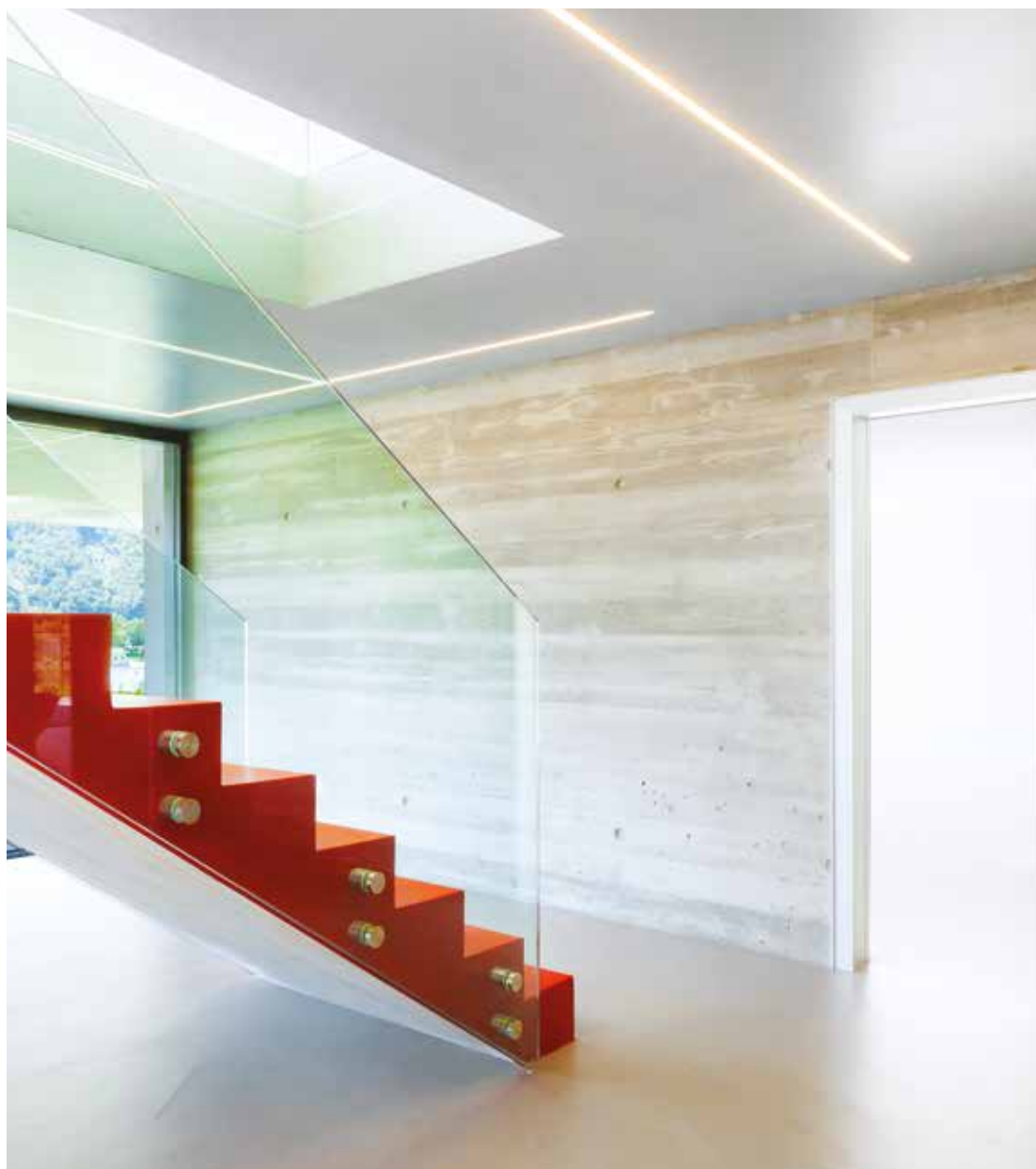

REBA 50 /E



Características do produto

Corpo

Perfil de alumínio extrudido

Acabamento

Revestido a epóxi-poliéster

Sistema de fixação

Niveladores

Sistema ótico

bGLARE - Difusor microprismático

bLINE - Difusor opalino

ASYM - Difusor assimétrico

Fonte de luz

LED, RG1, CRI>80, MacAdam Step ≤ 3

Vida útil LED

80.000h @ L90, B10, Ta 25°C

Fonte de alimentação

Driver LED 220-240V-50/60Hz incluído

Espessura do teto

Para tetos entre 1-25 mm

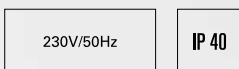

01. Seleccionar perfil exterior

PERFIL EXTERIOR

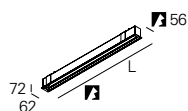

Lmm		CÓDIGO*
590	580	90520L0020▲0000
870	860	90520L0030▲0000
1150	1140	90520L0040▲0000
1430	1420	90520L0050▲0000
1710	1700	90520L0060▲0000
1992	1982	90520L0070▲0000
2272	2262	90520L0080▲0000
2552	2542	90520L0090▲0000
2832	2822	90520L0100▲0000



*Substitua os símbolos para completar o código

Cor	▲
<input type="checkbox"/> Branco	W
<input type="checkbox"/> Cinzento	G
<input type="checkbox"/> Preto	B

PERFIL EXTERIOR

• Para completar o produto é necessário encomendar o perfil interior em separado.

02. Seleccionar perfil interior e difusor

PERFIL INTERIOR | SIMÉTRICO

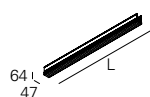

bGLARE - Difusor microprismático

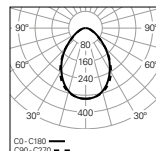

W	lm output	lm/W	Lmm	CÓDIGO*
15	1603	107	562	90498L002▼W0◆00
22	2405	109	842	90498L003▼W0◆00
30	3207	107	1122	90498L004▼W0◆00
35	4008	115	1402	90498L005▼W0◆00
42	4810	115	1682	90498L006▼W0◆00
52	5612	108	1964	90498L007▼W0◆00
60	6413	107	2244	90498L008▼W0◆00
65	7215	111	2524	90498L009▼W0◆00
70	8017	115	2804	90498L010▼W0◆00

bLINE - Difusor opalino

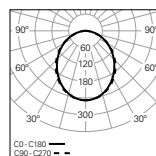

W	lm output	lm/W	Lmm	CÓDIGO*
15	1655	110	562	90497L002▼W0◆00
22	2483	113	842	90497L003▼W0◆00
30	3310	110	1122	90497L004▼W0◆00
35	4138	118	1402	90497L005▼W0◆00
42	4965	118	1682	90497L006▼W0◆00
52	5793	111	1964	90497L007▼W0◆00
60	6620	110	2244	90497L008▼W0◆00
65	7448	115	2524	90497L009▼W0◆00
70	8275	118	2804	90497L010▼W0◆00

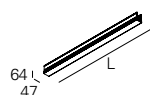

*Substitua os símbolos para completar o código

Fonte de alimentação	▼
HF	E
DALI	H

Emergência	●
No EM	0
EM 3h (K3) ^{1 2}	3

Temp. de Cor	◆
3000K	3
4000K	0
Tunable White ³	T

PERFIL INTERIOR | ASSIMÉTRICO

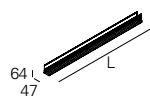

ASYM - Difusor

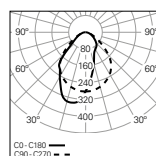

W	lm output	lm/W	Lmm	CÓDIGO*
16	1396	87	562	90500L002▼W0◆00
23	2095	91	842	90500L003▼W0◆00
29	2793	96	1122	90500L004▼W0◆00
36	3491	97	1402	90500L005▼W0◆00
44	4189	95	1682	90500L006▼W0◆00
52	4888	94	1964	90500L007▼W0◆00
58	5586	96	2244	90500L008▼W0◆00
65	6284	97	2524	90500L009▼W0◆00
73	6982	96	2804	90500L010▼W0◆00

¹ Preparado para telecomando.

² Versões DALI + EM 3h (K3) apenas disponível desde L1402 mm.

³ Apenas disponível nas versões DALI sem kit de emergência (No EM). Não disponível na versão L562 mm.

03. Selecionar opções

OPÇÕES	Código
SwitchDIM Tunable White • Para $L \leq 1682$ mm permite controlar no máximo 20 luminárias, $L \geq 1964$ mm permite controlar no máximo 10 luminárias por cada SwitchDIM Tunable White.	926600
Cabo de segurança em aço L1500 mm	955000
Versão Low Output • Sob consulta.	



Detalhes do produto



Perfil exterior



Nivelador



Perfil interior simétrico



Perfil interior assimétrico



Uniformidade de luz



Difusor clip-in



Aplicação de encastrar



Difusor bGLARE



Difusor bLINE



Difusor ASYM



SwitchDIM
Tunable White



REBA 50 /E Line

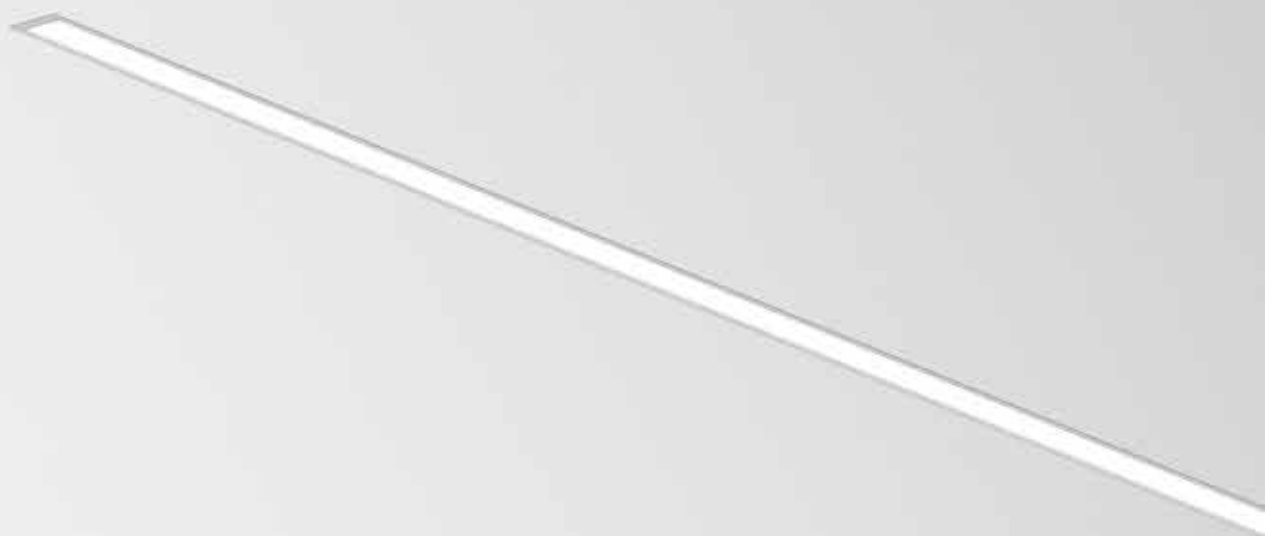

Características do produto

Corpo

Perfil de alumínio extrudido

Acabamento

Revestido a epóxi-poliéster

Sistema de fixação

Niveladores

Sistema ótico

bGLARE - Difusor microprismático

bLINE - Difusor opalino

ASYM - Difusor assimétrico

Fonte de luz

LED, RG1, CRI>80, MacAdam Step ≤ 3

Vida útil LED

80.000h @ L90, B10, Ta 25°C

Fonte de alimentação

Driver LED 220-240V-50/60Hz incluído

Espessura do teto

Para tetos entre 1-25 mm

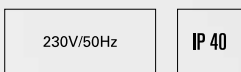

01. Selecionar perfil exterior



PERFIL EXTERIOR

Início / Fim (SRT/END)

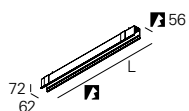

Lmm	∩	CÓDIGO*
567	568	90506L0020▲0083
847	848	90506L0030▲0083
1127	1128	90506L0040▲0083
1407	1408	90506L0050▲0083
1687	1688	90506L0060▲0083
1969	1970	90506L0070▲0083
2249	2250	90506L0080▲0083
2529	2530	90506L0090▲0083
2809	2810	90506L0100▲0083

*Substitua os símbolos para completar o código

Cor	▲
□ Branco	W
■ Cinzento	G
■ Preto	B

Intermédio (MID)

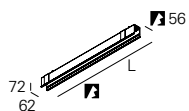

Lmm	∩	CÓDIGO*
562	562	90506L0020▲0000
842	842	90506L0030▲0000
1122	1122	90506L0040▲0000
1402	1402	90506L0050▲0000
1682	1682	90506L0060▲0000
1964	1964	90506L0070▲0000
2244	2244	90506L0080▲0000
2524	2524	90506L0090▲0000
2804	2804	90506L0100▲0000

Canto vertical (VRT)

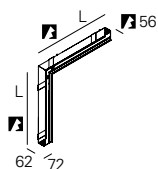

Lmm	∩	CÓDIGO*
606	536	90506V0040▲0000

Canto horizontal (HRZ) - Esquina horizontal (EDGE)

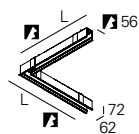

Lmm	∩	CÓDIGO*
607	604	90506H0040▲0000

PERFIL EXTERIOR

- Para completar o produto é necessário encomendar o perfil interior em separado.
- Para completar a linha é necessário encomendar start kit, cablagem de linha contínua e kit de união em separado.
- Dimensões não incluem start kit. Adicione 6 mm ao comprimento de corte para completar a dimensão de encaixe da linha.
- O comprimento máximo da linha com um único ponto de alimentação é 30000 mm.

02. Seleccionar perfil interior e difusor

PERFIL INTERIOR | SIMÉTRICO

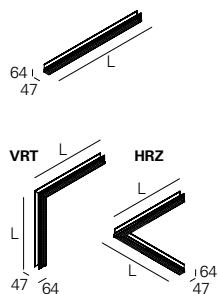

bGLARE - Difusor microprismático

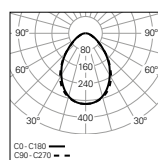

W	lm output	lm/W	Lmm	CÓDIGO*
15	1603	107	562	90498L002♥W0♦00
22	2405	109	842	90498L003♥W0♦00
30	3207	107	1122	90498L004♥W♦♦00
35	4008	115	1402	90498L005♥W♦♦00
42	4810	115	1682	90498L006♥W♦♦00
52	5612	108	1964	90498L007♥W♦♦00
60	6413	107	2244	90498L008♥W♦♦00
65	7215	111	2524	90498L009♥W♦♦00
70	8017	115	2804	90498L010♥W♦♦00

VRT	30	3207	107	599	90498V004♥W0♦00
HRZ	30	3207	107	577	90498H004♥W0♦00

bLINE - Difusor opalino

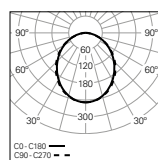

W	lm output	lm/W	Lmm	CÓDIGO*
15	1655	110	562	90497L002♥W0♦00
22	2483	113	842	90497L003♥W0♦00
30	3310	110	1122	90497L004♥W♦♦00
35	4138	118	1402	90497L005♥W♦♦00
42	4965	118	1682	90497L006♥W♦♦00
52	5793	111	1964	90497L007♥W♦♦00
60	6620	110	2244	90497L008♥W♦♦00
65	7448	115	2524	90497L009♥W♦♦00
70	8275	118	2804	90497L010♥W♦♦00

VRT	30	3310	110	599	90497V004♥W0♦00
HRZ	30	3310	110	577	90497H004♥W0♦00

PERFIL INTERIOR | ASSIMÉTRICO

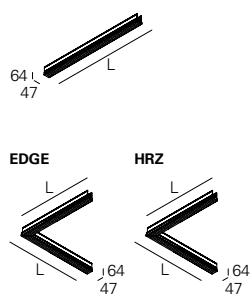

ASYM - Difusor

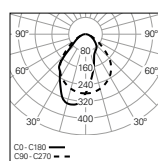

W	lm output	lm/W	Lmm	CÓDIGO*
16	1396	87	562	90500L002♥W0♦00
23	2095	91	842	90500L003♥W0♦00
29	2793	96	1122	90500L004♥W♦♦00
36	3491	97	1402	90500L005♥W♦♦00
44	4189	95	1682	90500L006♥W♦♦00
52	4888	94	1964	90500L007♥W♦♦00
58	5586	96	2244	90500L008♥W♦♦00
65	6284	97	2524	90500L009♥W♦♦00
73	6982	96	2804	90500L010♥W♦♦00

EDGE	29	2793	96	599	90500E004♥W0♦00
HRZ	29	2793	96	577	90500H004♥W0♦00



*Substitua os símbolos para completar o código

Fonte de alimentação ♥
HF E
DALI H

Emergência ●
No EM 0
EM 3h (K3) ^{1 2} 3

Temp. de Cor ♦
3000K 3
4000K 0
Tunable White ³ T

¹ Preparado para telecomando.

² Versões DALI + EM 3h (K3) apenas disponível desde L1402 mm.

³ Apenas disponível nas versões DALI sem kit de emergência (No EM). Não disponível na versão L562 mm.

03. Selecionar opções

OPÇÕES	Código*
SwitchDIM Tunable White • Para L ≤ 1682 mm permite controlar no máximo 20 luminárias, L ≥ 1964 mm permite controlar no máximo 10 luminárias por cada SwitchDIM Tunable White.	926600
Start kit - topo início/fim • Dois topos incluídos.	72 923200♣ 62 9
Cablagem linha contínua • Standard 3 x 1,5 mm ² 5 x 1,5 mm ²	945650 945750
• 2 x 1,5 mm² HF+K3 (x1) - L562 - L1682 mm HF+K3 (x2) - L1964 - L2804 mm	948000 948001
• 2 x 1,5 mm² + Junção 5P DALI+K3 (x1) - L562 - L1682 mm DALI+K3 (x2) - L1964 - L2804 mm	948200 948201
• 2 x 1,5 mm² + 2 x 0,75 mm² + Junção 5P K3+TEL (x1) - L562 - L1682 mm K3+TEL (x2) - L1964 - L2804 mm	948100 948101
Kit de união • União galvanizada, parafusos incluídos.	932100
Módulo cego L1500 mm L3000 mm • Inclui perfil interior e tampa de encaixe em alumínio.	992920♣ 992921♣
Cabo de segurança em aço L1500 mm	955000
Versão Low Output • Sob consulta.	
Projetos à medida • Sob consulta.	



*Substitua os símbolos para completar o código

Cor	♣
□ Branco	W
■ Cinzento	G
■ Preto	B



Detalhes do produto



Perfil exterior



Perfil interior simétrico



Perfil interior assimétrico



Uniformidade de luz



Nivelador



Difusor clip-in



Canto vertical

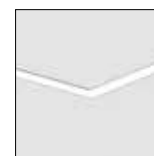

Canto horizontal



Aplicação de encastrar



Difusor bGLARE



Difusor bLINE



Difusor ASYM



SwitchDIM Tunable White



Start kit



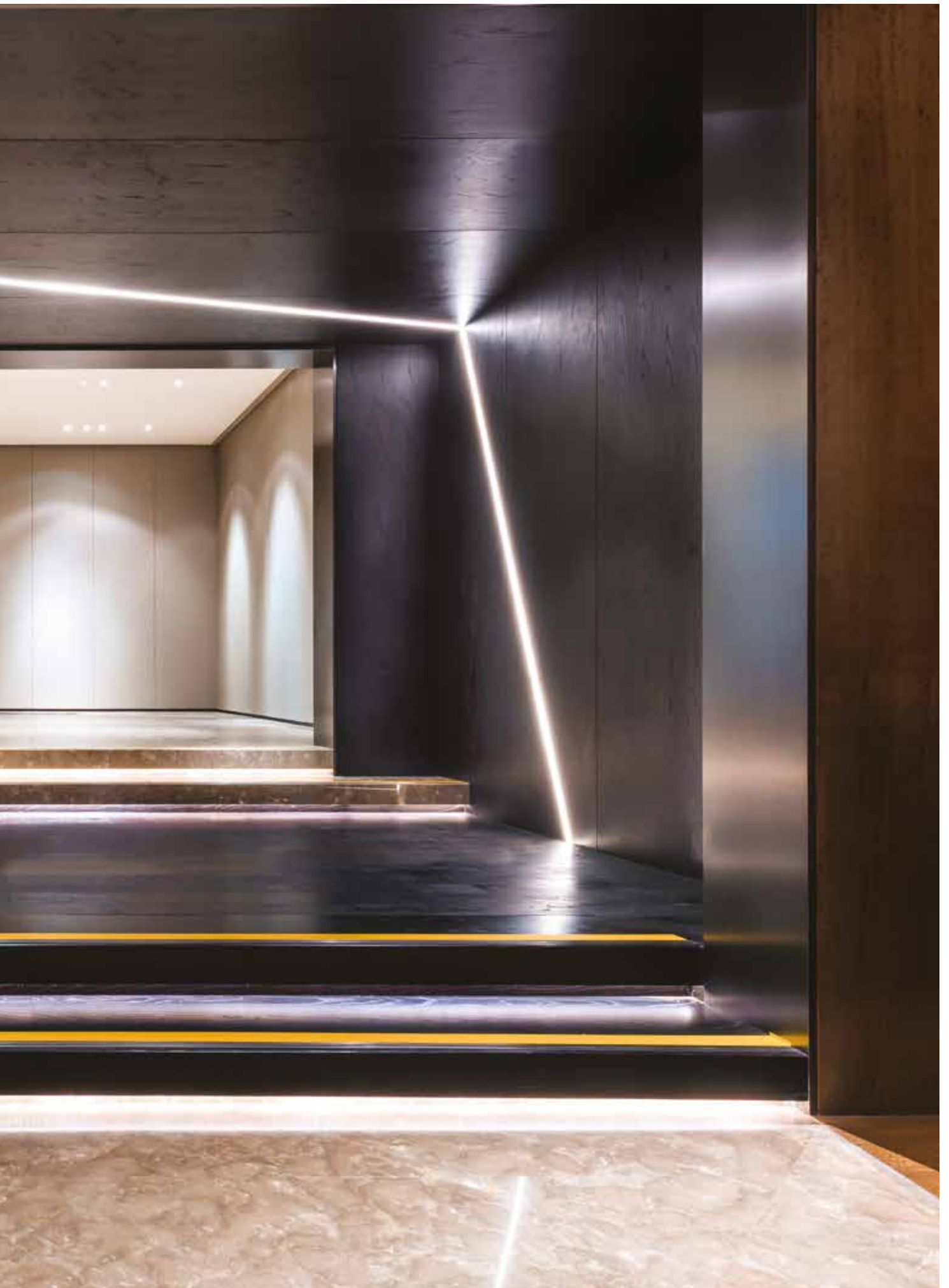

REBA 50



Características do produto

Corpo

Perfil de alumínio extrudido

Acabamento

Revestido a epóxi-poliéster

Sistema ótico

bGLARE - Difusor microprismático

bLINE - Difusor opalino

ASYM - Difusor assimétrico

Fonte de luz

LED, RG1, CRI>80, MacAdam Step ≤ 3

Vida útil LED

80.000h @ L90, B10, Ta 25°C

Fonte de alimentação

Driver LED 220-240V-50/60Hz incluído



01. Selecionar perfil exterior

PERFIL EXTERIOR

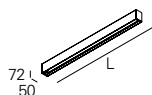

Lmm	CÓDIGO*
578	90517L0020▲0000
858	90517L0030▲0000
1138	90517L0040▲0000
1418	90517L0050▲0000
1698	90517L0060▲0000
1980	90517L0070▲0000
2260	90517L0080▲0000
2540	90517L0090▲0000
2820	90517L0100▲0000



*Substitua os símbolos para completar o código

Cor	▲
□ Branco	W
■ Cinzento	G
■ Preto	B

PERFIL EXTERIOR

- Para completar o produto é necessário encomendar o perfil interior em separado.
- Para versão suspensa é necessário encomendar suspensão, cabo e caixa de alimentação em separado.

02. Selecionar perfil interior e difusor

PERFIL INTERIOR | SIMÉTRICO

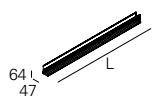

bGLARE - Difusor microprismático

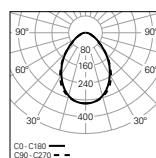

W	lm output	lm/W	Lmm	CÓDIGO*
15	1603	107	562	90498L002▼W0◆00
22	2405	109	842	90498L003▼W0◆00
30	3207	107	1122	90498L004▼W◆◆00
35	4008	115	1402	90498L005▼W◆◆00
42	4810	115	1682	90498L006▼W◆◆00
52	5612	108	1964	90498L007▼W◆◆00
60	6413	107	2244	90498L008▼W◆◆00
65	7215	111	2524	90498L009▼W◆◆00
70	8017	115	2804	90498L010▼W◆◆00

*Substitua os símbolos para completar o código

Fonte de alimentação	▼
HF	E
DALI	H

Emergência	●
No EM	0
EM 3h (K3) ^{1 2}	3

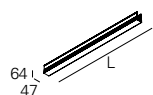

bLINE - Difusor opalino

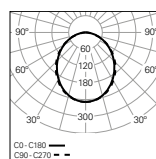

W	lm output	lm/W	Lmm	CÓDIGO*
15	1655	110	562	90497L002▼W0◆00
22	2483	113	842	90497L003▼W0◆00
30	3310	110	1122	90497L004▼W◆◆00
35	4138	118	1402	90497L005▼W◆◆00
42	4965	118	1682	90497L006▼W◆◆00
52	5793	111	1964	90497L007▼W◆◆00
60	6620	110	2244	90497L008▼W◆◆00
65	7448	115	2524	90497L009▼W◆◆00
70	8275	118	2804	90497L010▼W◆◆00

Temp. de Cor	◆
3000K	3
4000K	0
Tunable White ³	T

PERFIL INTERIOR | ASSIMÉTRICO

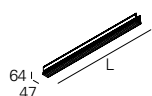

ASYM - Difusor

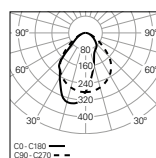

















W	lm output	lm/W	Lmm	CÓDIGO*
16	1396	87	562	90500L002▼W0◆00
23	2095	91	842	90500L003▼W0◆00
29	2793	96	1122	90500L004▼W◆◆00
36	3491	97	1402	90500L005▼W◆◆00
44	4189	95	1682	90500L006▼W◆◆00
52	4888	94	1964	90500L007▼W◆◆00
58	5586	96	2244	90500L008▼W◆◆00
65	6284	97	2524	90500L009▼W◆◆00
73	6982	96	2804	90500L010▼W◆◆00

¹ Preparado para telecomando.

² Versões DALI + EM 3h (K3) apenas disponível desde L1402 mm.

³ Apenas disponível nas versões DALI sem kit de emergência (No EM). Não disponível na versão L562 mm.

03. Selecionar opções

OPÇÕES	Código*
SwitchDIM Tunable White	926600
<ul style="list-style-type: none"> • Para $L \leq 1682$ mm permite controlar no máximo 20 luminárias, $L \geq 1964$ mm permite controlar no máximo 10 luminárias por cada SwitchDIM Tunable White. 	
Suspensão	
S5 L1500 mm (x1)	910408
S5 L1500 mm (x2)	910409
S5 L3000 mm (x1)	910419
S5 L3000 mm (x2)	910412
S5 L6000 mm (x1)	910420
S5 L6000 mm (x2)	910421
Cabo de alimentação transparente	
L1500 mm - 3 x 0,75 mm ²	940400
L1500 mm - 5 x 0,75 mm ²	940500
L1500 mm - 7 x 0,75 mm ²	940600
L3000 mm - 3 x 0,75 mm ²	940401
L3000 mm - 5 x 0,75 mm ²	940501
L3000 mm - 7 x 0,75 mm ²	940601
L6000 mm - 3 x 0,75 mm ²	940402
L6000 mm - 5 x 0,75 mm ²	940507
L6000 mm - 7 x 0,75 mm ²	940602
<ul style="list-style-type: none"> • Para a versão DALI com kit de emergência e telecomando é necessário encomendar 2 cabos de alimentação 5 x 0,75 mm². 	
Caixa de alimentação quadrada	
Saliente T25  45  100	978610 
Saliente T29 (DALI+K3)	978611 
Encastrar T7  Ø70 35  90	971400 
Encastrar T59 (DALI+K3)	971410 
Caixa de alimentação circular	
Saliente T24  45  Ø95	978600 
Saliente T26 (DALI+K3)	978601 
Encastrar T5  Ø70 33  Ø90	971300 
Encastrar T27 (DALI+K3)	978700 
Versão Low Output	
<ul style="list-style-type: none"> • Sob consulta. 	



*Substitua os símbolos para completar o código

Cor 

Branco W

Preto B



Detalhes do produto





REBA 50 Line



Características do produto

Corpo

Perfil de alumínio extrudido

Acabamento

Revestido a epóxi-poliéster

Sistema ótico

bGLARE - Difusor microprismático

bLINE - Difusor opalino

ASYM - Difusor assimétrico

Fonte de luz

LED, RG1, CRI>80, MacAdam Step ≤ 3

Vida útil LED

80.000h @ L90, B10, Ta 25°C

Fonte de alimentação

Driver LED 220-240V-50/60Hz incluído



230V/50Hz

IP 40

ASYM
850°C

bGLARE
850°C

bLINE
960°C

01. Selecionar perfil exterior



PERFIL EXTERIOR

Início / Fim (SRT/END)

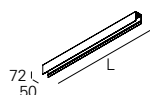

Lmm	CÓDIGO*
567	90505L0020▲0083
847	90505L0030▲0083
1127	90505L0040▲0083
1407	90505L0050▲0083
1687	90505L0060▲0083
1969	90505L0070▲0083
2249	90505L0080▲0083
2529	90505L0090▲0083
2809	90505L0100▲0083

*Substitua os símbolos para completar o código

Cor	▲
□ Branco	W
■ Cinzento	G
■ Preto	B

Intermédio (MID)

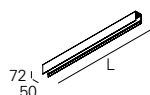

Lmm	CÓDIGO*
562	90505L0020▲0000
842	90505L0030▲0000
1122	90505L0040▲0000
1402	90505L0050▲0000
1682	90505L0060▲0000
1964	90505L0070▲0000
2244	90505L0080▲0000
2524	90505L0090▲0000
2804	90505L0100▲0000

Canto vertical (VRT)

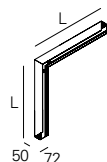

Lmm	CÓDIGO*
606	90505V0040▲0000

Canto horizontal (HRZ) - Esquina horizontal (EDGE)

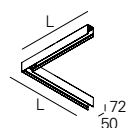

Lmm	CÓDIGO*
601	90505H0040▲0000

PERFIL EXTERIOR

- Para completar o produto é necessário encomendar o perfil interior em separado.
- Para versão suspensa é necessário encomendar suspensão, cabo e caixa de alimentação em separado.
- Para completar a linha é necessário encomendar start kit, cablagem de linha contínua e kit de união em separado.
- As dimensões não incluem start kit. Adicione 6 mm ao comprimento para completar a linha.
- O comprimento máximo da linha com um único ponto de alimentação é 30000 mm.

02. Seleccionar perfil interior e difusor



PERFIL INTERIOR | SIMÉTRICO

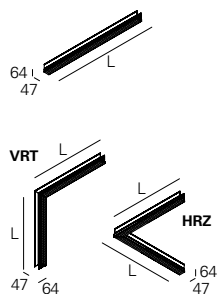

bGLARE - Difusor microprismático

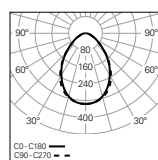

W	lm output	lm/W	Lmm	CÓDIGO*
15	1603	107	562	90498L002♥W0♦00
22	2405	109	842	90498L003♥W0♦00
30	3207	107	1122	90498L004♥W♦♦00
35	4008	115	1402	90498L005♥W♦♦00
42	4810	115	1682	90498L006♥W♦♦00
52	5612	108	1964	90498L007♥W♦♦00
60	6413	107	2244	90498L008♥W♦♦00
65	7215	111	2524	90498L009♥W♦♦00
70	8017	115	2804	90498L010♥W♦♦00
VRT	30	3207	107	90498V004♥W0♦00
HRZ	30	3207	107	90498H004♥W0♦00

bLINE - Difusor opalino

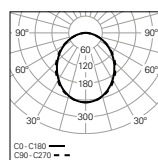

W	lm output	lm/W	Lmm	CÓDIGO*
15	1655	110	562	90497L002♥W0♦00
22	2483	113	842	90497L003♥W0♦00
30	3310	110	1122	90497L004♥W♦♦00
35	4138	118	1402	90497L005♥W♦♦00
42	4965	118	1682	90497L006♥W♦♦00
52	5793	111	1964	90497L007♥W♦♦00
60	6620	110	2244	90497L008♥W♦♦00
65	7448	115	2524	90497L009♥W♦♦00
70	8275	118	2804	90497L010♥W♦♦00
VRT	30	3310	110	90497V004♥W0♦00
HRZ	30	3310	110	90497H004♥W0♦00

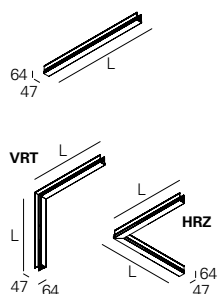

PERFIL INTERIOR | ASSIMÉTRICO

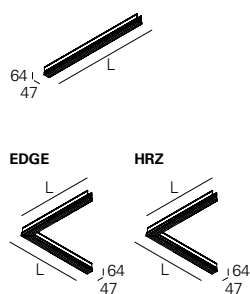

ASYM - Difusor

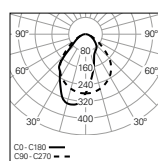

W	lm output	lm/W	Lmm	CÓDIGO*
16	1396	87	562	90500L002♥W0♦00
23	2095	91	842	90500L003♥W0♦00
29	2793	96	1122	90500L004♥W♦♦00
36	3491	97	1402	90500L005♥W♦♦00
44	4189	95	1682	90500L006♥W♦♦00
52	4888	94	1964	90500L007♥W♦♦00
58	5586	96	2244	90500L008♥W♦♦00
65	6284	97	2524	90500L009♥W♦♦00
73	6982	96	2804	90500L010♥W♦♦00
EDGE	29	2793	96	90500E004♥W0♦00
HRZ	29	2793	96	90500H004♥W0♦00

*Substitua os símbolos para completar o código

Fonte de alimentação ♥
HF E
DALI H

Emergência ●
No EM 0
EM 3h (K3) ^{1 2} 3

Temp. de Cor ♦
3000K 3
4000K 0
Tunable White ³ T

¹ Preparado para telecomando.

² Versões DALI + EM 3h (K3) apenas disponível desde L1402 mm.

³ Apenas disponível nas versões DALI sem kit de emergência (No EM). Não disponível na versão L562 mm.

03. Selecionar opções

OPÇÕES	Código*
SwitchDIM Tunable White	926600
• Para L ≤ 1682 mm permite controlar no máximo 20 luminárias, L ≥ 1964 mm permite controlar no máximo 10 luminárias por cada SwitchDIM Tunable White.	
Start kit - topo início/fim	72 50 3 923100▲
• Dois topos incluídos.	
Cablagem linha contínua	
• Standard	
3 x 1,5 mm ²	945650
5 x 1,5 mm ²	945750
• 2 x 1,5 mm²	
HF+K3 (x1) - L562 - L1682 mm	948000
HF+K3 (x2) - L1964 - L2804 mm	948001
• 2 x 1,5 mm² + Junção 5P	
DALI+K3 (x1) - L562 - L1682 mm	948200
DALI+K3 (x2) - L1964 - L2804 mm	948201
• 2 x 1,5 mm² + 2 x 0,75 mm² + Junção 5P	
K3+TEL (x1) - L562 - L1682 mm	948100
K3+TEL (x2) - L1964 - L2804 mm	948101
Kit de união	932100
• União galvanizada, parafusos incluídos.	
Suspensão	
S5 L1500 mm (x1)	910408
S5 L1500 mm (x2)	910409
S5 L3000 mm (x1)	910419
S5 L3000 mm (x2)	910412
S5 L6000 mm (x1)	910420
S5 L6000 mm (x2)	910421
Cabo de alimentação transparente	
3 x 1,5 mm ²	94030▲
5 x 1,5 mm ²	94000▲
7 x 1,5 mm ²	94010▲
• Para a versão DALI com kit de emergência e telecomando é necessário encomendar 2 cabos de alimentação 5 x 1,5 mm ² .	
Caixa de alimentação quadrada³	
Saliente T25	45 100 978610▲
Saliente T29 (DALI+K3)	978611▲
Encastrar T7	Ø70 35 90 971400▲
Encastrar T59 (DALI+K3)	971410▲
Caixa de alimentação circular³	
Saliente T24	45 Ø95 978600▲
Saliente T26 (DALI+K3)	978601▲
Encastrar T5	Ø70 33 Ø90 971300▲
Encastrar T27 (DALI+K3)	978700▲
Módulo cego	
L1500 mm	992900▲
L3000 mm	992901▲
• Inclui perfil interior e tampa de encaixe em alumínio.	
Versão Low Output	
• Sob consulta.	
Projetos à medida	
• Sob consulta.	



*Substitua os símbolos para completar o código

Comprimento	▲
L1500 mm	0
L3000 mm	1
L6000 mm	2

Cor ³	▲
□ Branco	W
■ Cinzento	G
■ Preto	B



Detalhes do produto



³ As caixas de alimentação apenas estão disponíveis na cor branca ou preta.

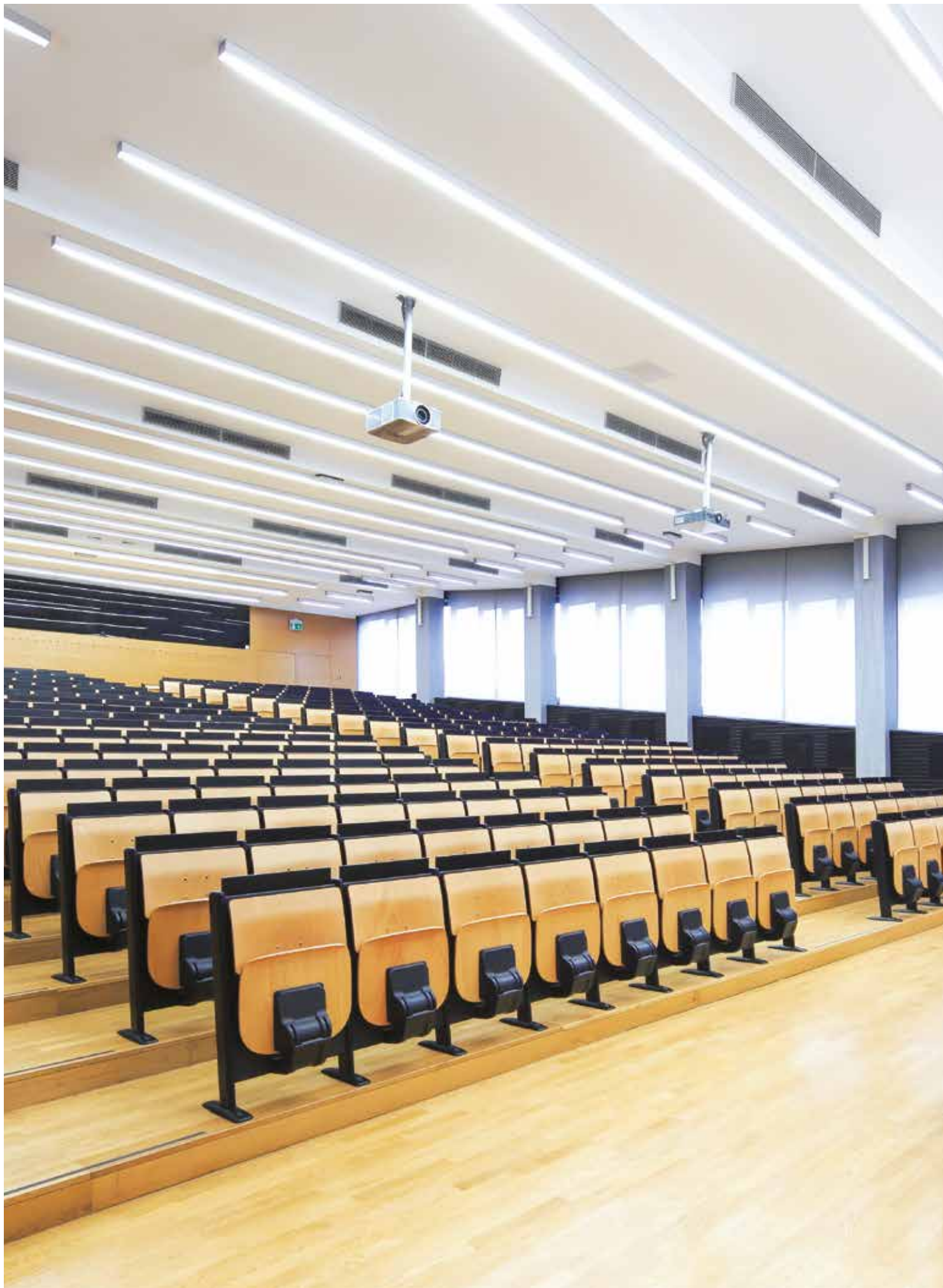



Composição de elementos estruturais

1. Topos

2. Perfil exterior

- 2.1 Módulo início / fim (SRT/END).
- 2.2 Módulo intermédio (MID).

3. Difusores

- 3.1 Difusor bGLARE
- 3.2 Difusor bLINE

4. Kit de união

- 4.1 2 vias
- 4.2 3 vias

5. Caixas de alimentação

6. Cabo de alimentação

7. Suspensão

Módulos disponíveis

(Vista de cima)

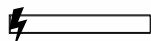

Módulo início / fim (SRT/END)

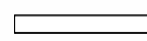

Módulo intermédio (MID)

Como estruturar uma linha

(Vista de cima)

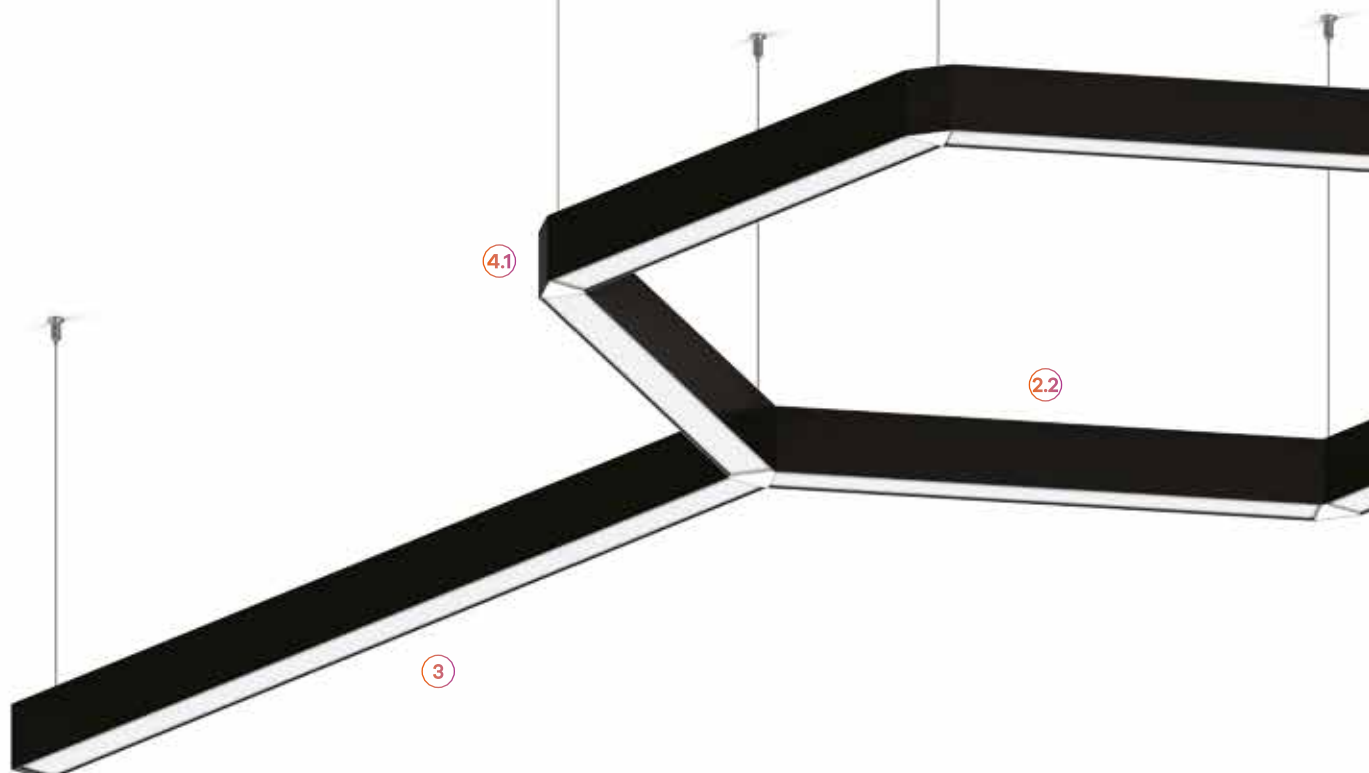
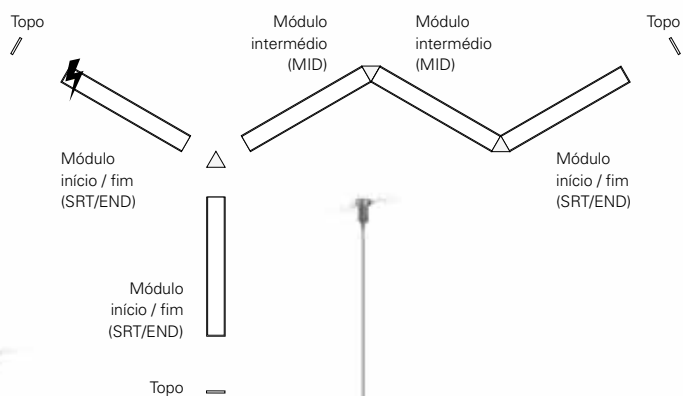

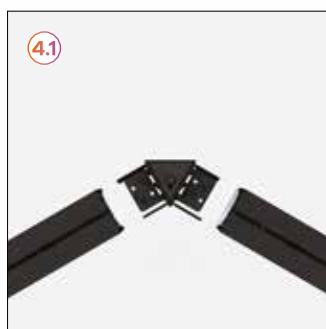
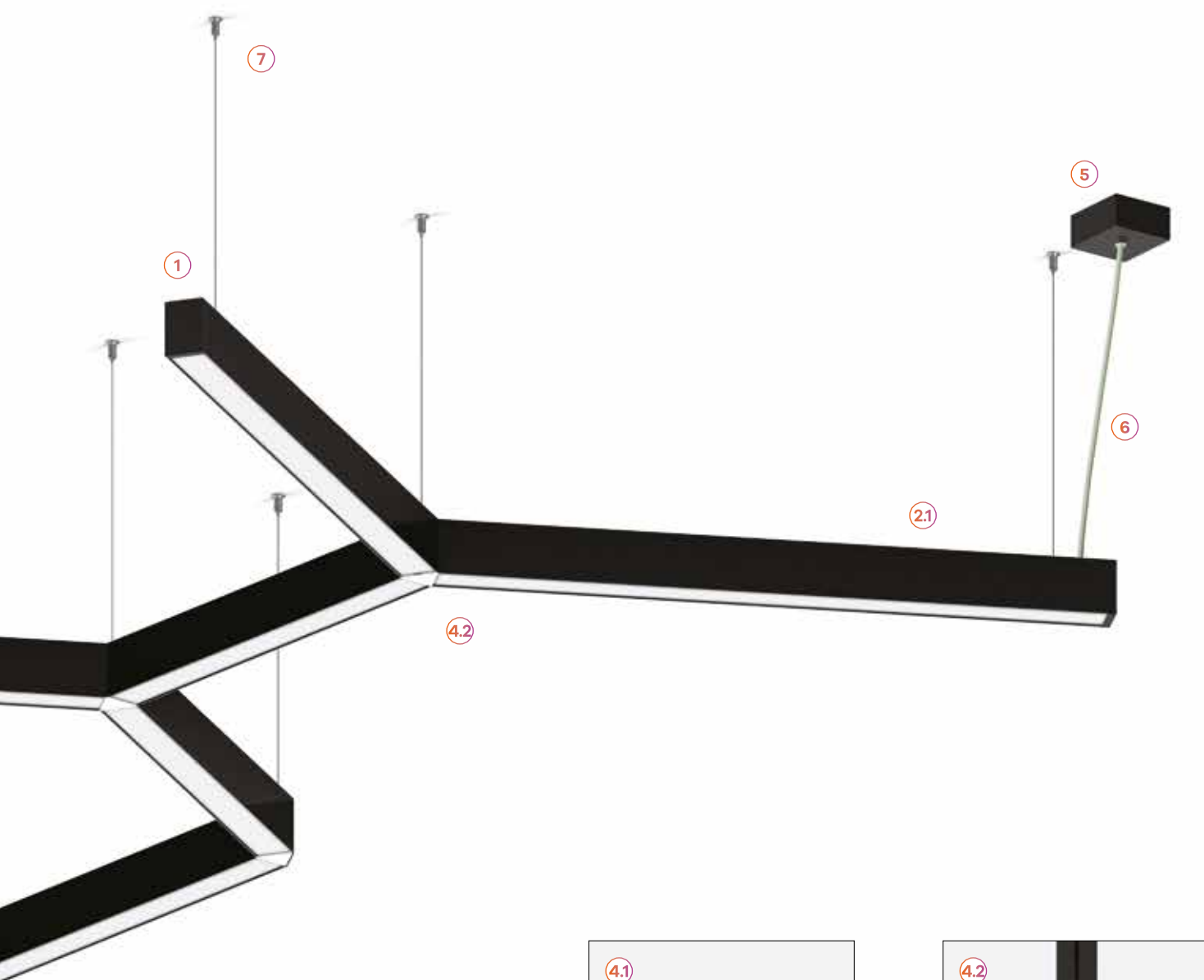

Uma escolha versátil para o seu projeto

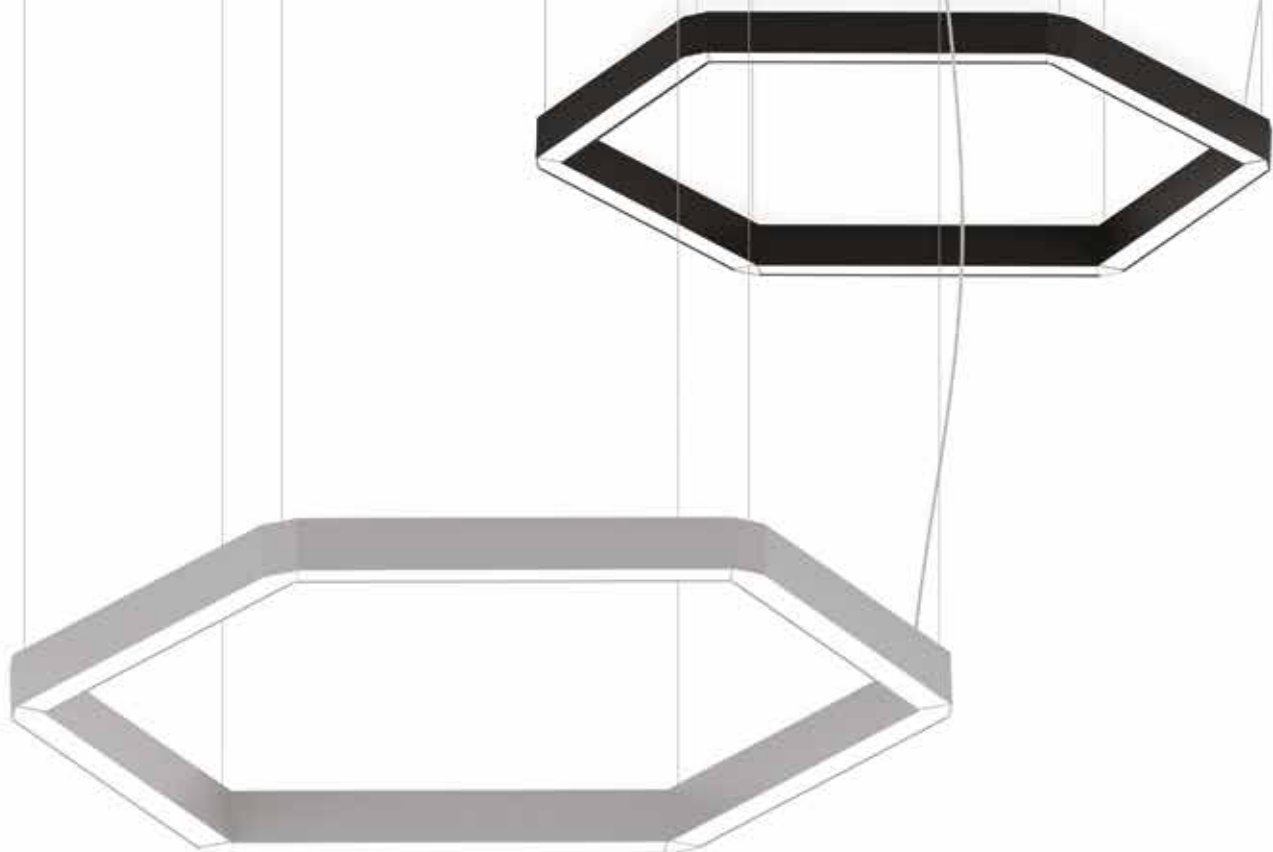

COMPOSTO
(vários módulos)

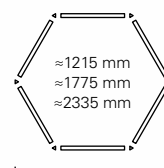

Módulos disponíveis

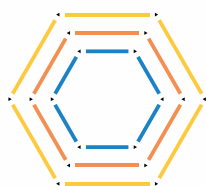

Escala 1:100 1000 mm

	Nº DE MÓDULOS	KIT DE UNIÃO	Nº DE SUSPENSÕES
--	---------------	--------------	------------------

562 mm	6	6 (2 vias)	6
842 mm	6	6 (2 vias)	6
1122 mm	6	6 (2 vias)	6

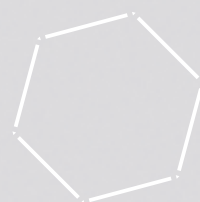
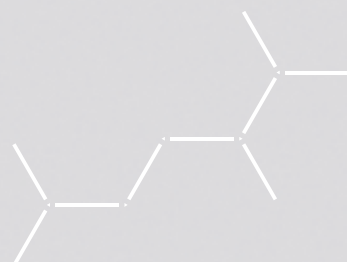
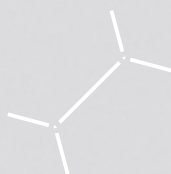
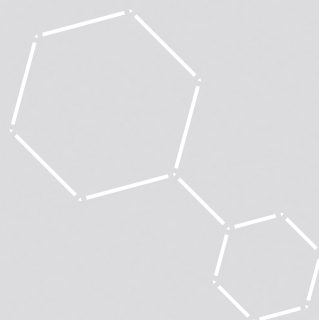
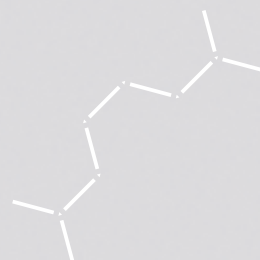
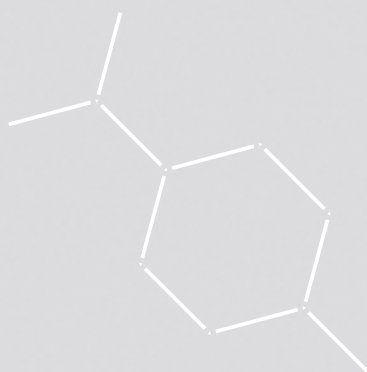
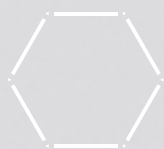
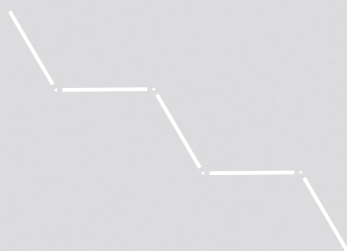

REBA 50 HEXA



Características do produto

Corpo

Perfil de alumínio extrudido

Acabamento

Revestido a epóxi-poliéster

Sistema ótico

bGLARE - Difusor microprismático
bLINE - Difusor opalino

Fonte de luz

LED, RG1, CRI>80, MacAdam Step ≤3

Vida útil LED

80.000h @ L90, B10, Ta 25°C

Fonte de alimentação

Driver LED 220-240V-50/60Hz incluído



230V/50Hz

IP 40

bGLARE
850°C

bLINE
960°C

01. Selecionar perfil exterior

PERFIL EXTERIOR

Início / Fim (SRT/END)

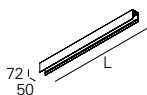

Lmm	CÓDIGO*
567	90505L0020▲0083
847	90505L0030▲0083
1127	90505L0040▲0083

Intermédio (MID)

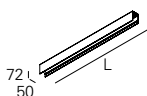

Lmm	CÓDIGO*
562	90860L0020▲0000
842	90860L0030▲0000
1122	90860L0040▲0000

PERFIL EXTERIOR

- Para completar o produto é necessário encomendar o perfil interior em separado.
- Para versão suspensa é necessário encomendar suspensão, cabo e caixa de alimentação em separado.
- Para completar a linha é necessário encomendar start kit, cablagem de linha contínua e kit de união em separado.
- As dimensões não incluem start kit. Adicione 6 mm ao comprimento para completar a linha.
- O comprimento máximo da linha com um único ponto de alimentação está sob consulta.



*Substitua os símbolos para completar o código

Cor	▲
□ Branco	W
■ Cinzento	G
■ Preto	B

02. Selecionar perfil interior e difusor

PERFIL INTERIOR | SIMÉTRICO

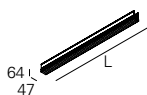

bGLARE - Difusor microprismático

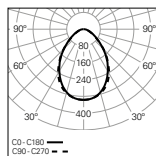

W	lm output	lm/W	Lmm	CÓDIGO*
15	1603	107	562	90816L002▼W0♦00
22	2405	109	842	90816L003▼W0♦00
30	3207	107	1122	90816L004▼W0♦00

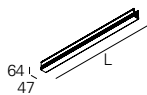

bLINE - Difusor opalino

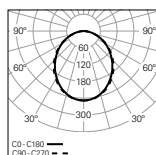

W	lm output	lm/W	Lmm	CÓDIGO*
15	1655	110	562	90814L002▼W0♦00
22	2483	113	842	90814L003▼W0♦00
30	3310	110	1122	90814L004▼W0♦00



*Substitua os símbolos para completar o código

Fonte de alimentação	▼
HF	E
DALI	H

Temp. de Cor	♦
3000K	3
4000K	0

03. Selecionar opções

OPÇÕES		Código*
Start kit - topo início/fim (x1)	72 50 3	923101▲
Kit de União		
2 vias HF		932148▲
2 vias DALI		932149▲
3 vias HF		932150▲
3 vias DALI		932151▲
<ul style="list-style-type: none"> • Tampa da união em branco. • Cablagem linha contínua incluída. 		
Suspensão		
S5 L1500 mm (x1)		910408
S5 L1500 mm (x2)		910409
S5 L3000 mm (x1)		910419
S5 L3000 mm (x2)		910412
S5 L6000 mm (x1)		910420
S5 L6000 mm (x2)		910421
Cabo de alimentação transparente		
3 x 1,5 mm ²		94030▲
5 x 1,5 mm ²		94000▲
Caixa de alimentação quadrada¹		
Saliente T25	45 100	978610▲
Encastrar T7	Ø70 35 90	971400▲
Caixa de alimentação circular¹		
Saliente T24	45 Ø95	978600▲
Encastrar T5	Ø70 33 Ø90	971300▲
Versão Low Output		
• Sob consulta.		
Projetos à medida		
• Sob consulta.		



*Substitua os símbolos para completar o código

Comprimento	▲
L1500 mm	0
L3000 mm	1
L6000 mm	2

Cor ¹	▲
□ Branco	W
■ Cinzento	G
■ Preto	B



Detalhes do produto



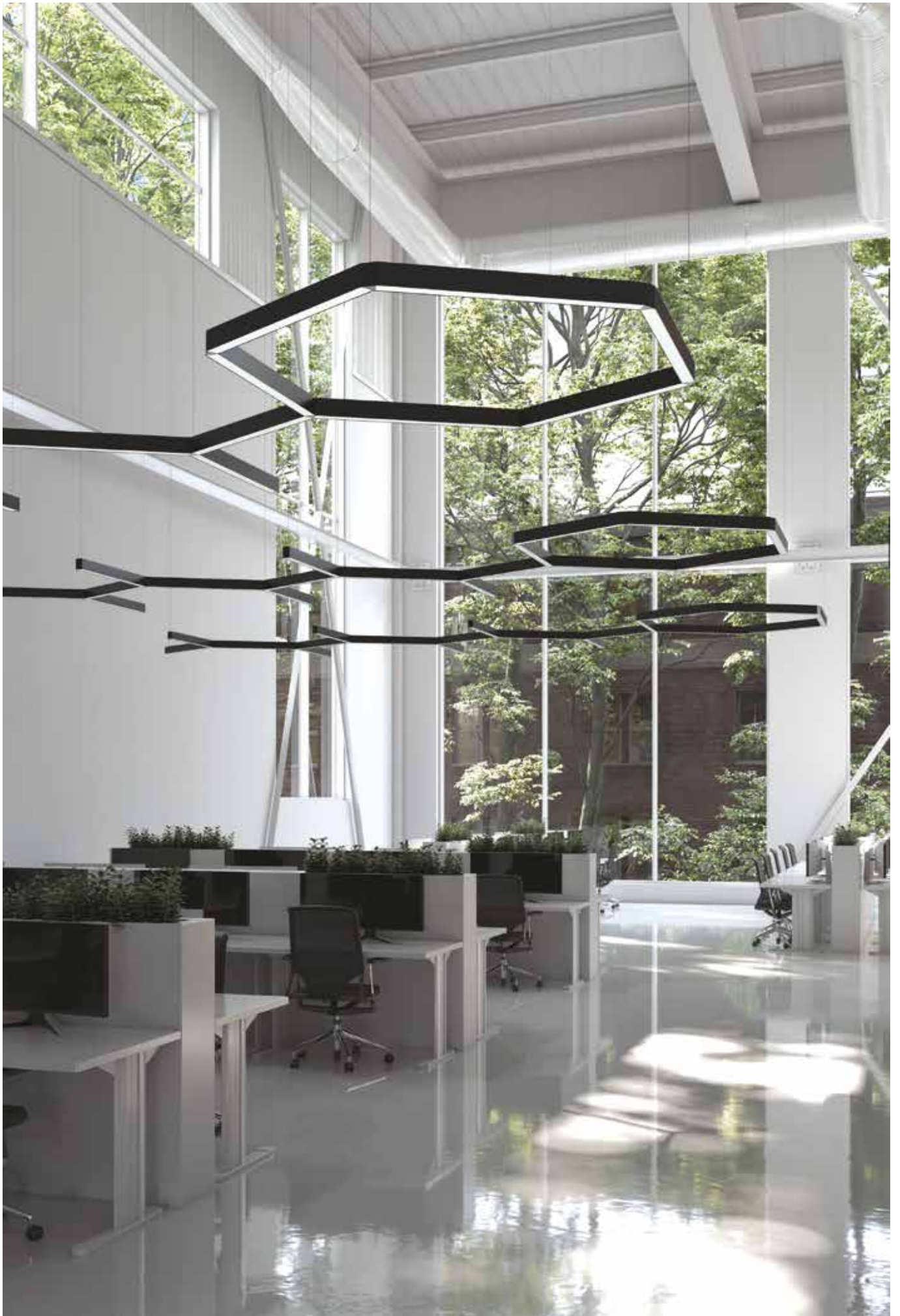

REBA 50 D/I



Características do produto

Corpo

Perfil de alumínio extrudido

Acabamento

Revestido a epóxi-poliéster

Sistema ótico

bGLARE - Difusor microprismático

bLINE - Difusor opalino

ASYM - Difusor assimétrico

Fonte de luz

LED, RG1, CRI>80, MacAdam Step ≤3

Vida útil LED

80.000h @ L90, B10, Ta 25°C

Fonte de alimentação

Driver LED 220-240V-50/60Hz incluído



230V/50Hz

IP 40

ASYM
850°C

bGLARE
850°C

bLINE
960°C

01. Selecionar perfil exterior

PERFIL EXTERIOR

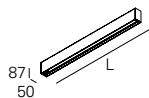

Lmm	CÓDIGO*
1138	90523L0040▲0000
1418	90523L0050▲0000
1698	90523L0060▲0000
2260	90523L0080▲0000
2540	90523L0090▲0000
2820	90523L0100▲0000



*Substitua os símbolos para completar o código

Cor	▲
□ Branco	W
■ Cinzento	G
■ Preto	B

PERFIL EXTERIOR

- Difusor da parte indireta incluído no produto.
- Para completar o produto é necessário encomendar o perfil interior, suspensão, cabo e caixa de alimentação em separado.

02. Selecionar perfil interior e difusor

PERFIL INTERIOR | SIMÉTRICO

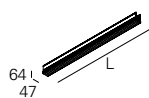

bGLARE - Difusor micropismático (60%/40%)

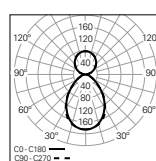

W	lm output	lm/W	Lmm	CÓDIGO*
52	5159	99	1122	90528L004▼W0♦00
65	6633	102	1402	90528L005▼W0♦00
77	8107	105	1682	90528L006▼W0♦00
102	10318	101	2244	90528L008▼W0♦00
117	11792	101	2524	90528L009▼W0♦00
130	13266	102	2804	90528L010▼W0♦00

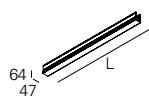

bLINE - Difusor opalino (60%/40%)

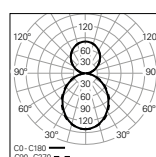

W	lm output	lm/W	Lmm	CÓDIGO*
52	5250	101	1122	90527L004▼W0♦00
65	6749	104	1402	90527L005▼W0♦00
77	8249	107	1682	90527L006▼W0♦00
102	10499	103	2244	90527L008▼W0♦00
117	11999	103	2524	90527L009▼W0♦00
130	13499	104	2804	90527L010▼W0♦00



*Substitua os símbolos para completar o código

Fonte de alimentação	▼
HF	E
DALI	H
HF+CD ¹	Q
SWD+CD ²	Y

Emergência	●
No EM	0
EM 3h (K3) ³	3

Temp. de Cor	♦
3000K	3
4000K	0
Tunable White ⁴	T

PERFIL INTERIOR | ASSIMÉTRICO

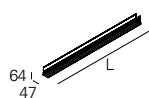

ASYM - Difusor (60%/40%)

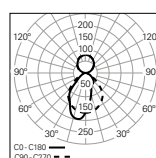

W	lm output	lm/W	Lmm	CÓDIGO*
51	4707	92	1122	90530L004▼W0♦00
66	6051	92	1402	90530L005▼W0♦00
79	7396	94	1682	90530L006▼W0♦00
100	9413	94	2244	90530L008▼W0♦00
117	10758	92	2524	90530L009▼W0♦00
133	12102	91	2804	90530L010▼W0♦00









¹ HF + circuito duplo.

² SwitchDIM + circuito duplo.

³ Preparado para telecomando.

⁴ Apenas disponível nas versões DALI e SWD+CD sem kit de emergência (No EM).

03. Selecionar opções

OPÇÕES	Código*
SwitchDIM Tunable White	926600
<ul style="list-style-type: none"> • Para $L \leq 1682$ mm permite controlar no máximo 10 luminárias, $L \geq 1964$ mm permite controlar no máximo 5 luminárias por cada SwitchDIM Tunable White. 	
Suspensão	
S5 L1500 mm (x1)	910408
S5 L1500 mm (x2)	910409
S5 L3000 mm (x1)	910419
S5 L3000 mm (x2)	910412
S5 L6000 mm (x1)	910420
S5 L6000 mm (x2)	910421
Cabo de alimentação transparente	
L1500 mm - 3 x 0,75 mm ²	940400
L1500 mm - 5 x 0,75 mm ²	940500
L1500 mm - 7 x 0,75 mm ²	940600
L3000 mm - 3 x 0,75 mm ²	940401
L3000 mm - 5 x 0,75 mm ²	940501
L3000 mm - 7 x 0,75 mm ²	940601
L6000 mm - 3 x 0,75 mm ²	940402
L6000 mm - 5 x 0,75 mm ²	940507
L6000 mm - 7 x 0,75 mm ²	940602
<ul style="list-style-type: none"> • Para a versão DALI com kit de emergência e telecomando é necessário encomendar 2 cabos de alimentação 5 x 0,75 mm². 	
Caixa de alimentação quadrada	
Saliente T25  45 l  100	978610
Saliente T29 (DALI+K3)	978611
Encastrar T7  Ø70 35 l  90	971400
Encastrar T59 (DALI+K3)	971410
Caixa de alimentação circular	
Saliente T24  45 l  Ø95	978600
Saliente T26 (DALI+K3)	978601
Encastrar T5  Ø70 33 l  Ø90	971300
Encastrar T27 (DALI+K3)	978700
Versão Low Output	
<ul style="list-style-type: none"> • Sob consulta. 	



*Substitua os símbolos para completar o código

Cor

<input type="checkbox"/> Branco	W
<input checked="" type="checkbox"/> Preto	B



Detalhes do produto

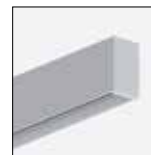

Perfil exterior



Perfil interior simétrico



Perfil interior assimétrico

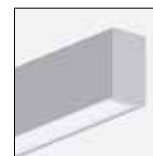

Topos sem parafusos visíveis



Uniformidade de luz



Suspensão



Difusor clip-in

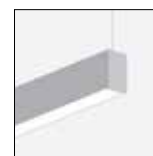

Aplicação suspensa



Difusor bGLARE



Difusor bLINE



Difusor ASYM



SwitchDIM Tunable White

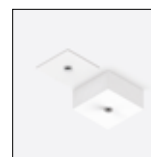

Caixas de alimentação quadradas



Caixas de alimentação circulares



REBA 50 D/I Line



Características do produto

Corpo

Perfil de alumínio extrudido

Acabamento

Revestido a epóxi-poliéster

Sistema ótico

bGLARE - Difusor microprismático

bLINE - Difusor opalino

ASYM - Difusor assimétrico

Fonte de luz

LED, RG1, CRI>80, MacAdam Step ≤ 3

Vida útil LED

80.000h @ L90, B10, Ta 25°C

Fonte de alimentação

Driver LED 220-240V-50/60Hz incluído



230V/50Hz

IP 40

ASYM
850°C

bGLARE
850°C

bLINE
960°C

01. Seleccionar perfil exterior



PERFIL EXTERIOR

Início / Fim (SRT/END)

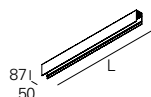

Lmm	CÓDIGO*
1127	90508L0040▲0083
1407	90508L0050▲0083
1687	90508L0060▲0083
2249	90508L0080▲0083
2529	90508L0090▲0083
2809	90508L0100▲0083

Intermédio (MID)

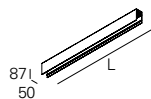

Lmm	CÓDIGO*
1122	90508L0040▲0000
1402	90508L0050▲0000
1682	90508L0060▲0000
2244	90508L0080▲0000
2524	90508L0090▲0000
2804	90508L0100▲0000

Canto horizontal (HRZ) - Esquina horizontal (EDGE)

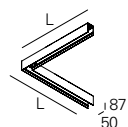

Lmm	CÓDIGO*
601	90508H0040▲0000

*Substitua os símbolos para completar o código

Cor	▲
□ Branco	W
■ Cinzento	G
■ Preto	B

PERFIL EXTERIOR

- Difusor da parte indireta incluído no produto.
- Para completar o produto é necessário encomendar o perfil interior em separado.
- Para versão suspensa é necessário encomendar suspensão, cabo e caixa de alimentação em separado.
- Para completar a linha é necessário encomendar start kit, cablagem de linha contínua e kit de união em separado.
- Dimensões não incluem start kit. Adicione 6 mm ao comprimento para completar a linha.
- O comprimento máximo da linha com um único ponto de alimentação é 15000 mm.

02. Selecionar perfil interior e difusor



PERFIL INTERIOR | SIMÉTRICO

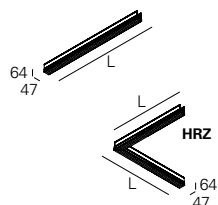

bGLARE - Difusor microprismático (60%/40%)

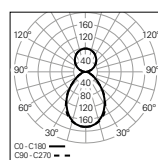

W	lm output	lm/W	Lmm	CÓDIGO*	
52	5159	99	1120	90528L004♥W0♦00	
65	6633	102	1400	90528L005♥W0♦00	
77	8107	105	1680	90528L006♥W♦♦00	
102	10318	101	2240	90528L008♥W0♦00	
117	11792	101	2520	90528L009♥W0♦00	
130	13266	102	2800	90528L010♥W0♦00	
HRZ	45	4422	98	597	90528H004♥W0♦00

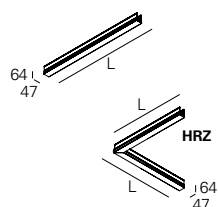

bLINE - Difusor opalino (60%/40%)

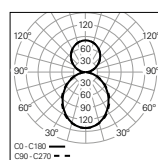

W	lm output	lm/W	Lmm	CÓDIGO*	
52	5250	101	1120	90527L004♥W0♦00	
65	6749	104	1400	90527L005♥W0♦00	
77	8249	107	1680	90527L006♥W♦♦00	
102	10499	103	2240	90527L008♥W0♦00	
117	11999	103	2520	90527L009♥W0♦00	
130	13499	104	2800	90527L010♥W0♦00	
HRZ	45	4500	100	597	90527H004♥W0♦00

*Substitua os símbolos para completar o código

Fonte de alimentação

HF	E
DALI	H
HF+CD ¹	Q
SWD+CD ²	Y

Emergência

No EM	0
EM 3h (K3) ³	3

Temp. de Cor

3000K	3
4000K	0
Tunable White ⁴	T

PERFIL INTERIOR | ASSIMÉTRICO

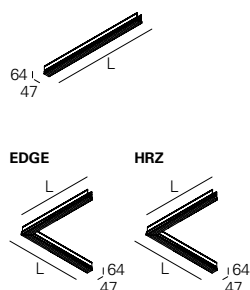

ASYM - Difusor (60%/40%)

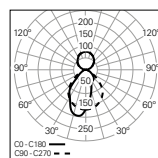

W	lm output	lm/W	Lmm	CÓDIGO*	
51	4707	92	1120	90530L004♥W0♦00	
66	6051	92	1400	90530L005♥W0♦00	
79	7396	94	1680	90530L006♥W♦♦00	
100	9413	94	2240	90530L008♥W0♦00	
117	10758	92	2520	90530L009♥W0♦00	
133	12102	91	2800	90530L010♥W0♦00	
EDGE	44	4034	92	597	90530E004♥W0♦00
HRZ	44	4034	92	597	90530H004♥W0♦00





¹ HF + circuito duplo.

² SwitchDIM + circuito duplo.

³ Preparado para telecomando.

⁴ Apenas disponível nas versões DALI e SWD+CD sem kit de emergência (No EM).

03. Selecionar opções

OPÇÕES	Código*
SwitchDIM Tunable White	926600
• Para L ≤ 1682 mm permite controlar no máximo 20 luminárias, L ≥ 1964 mm permite controlar no máximo 10 luminárias por cada SwitchDIM Tunable White.	
Start kit - topo início/fim	923300▲
• Dois topos incluídos.	
Cablagem linha contínua	
• Standard	
3 x 1,5 mm ²	945650
4 x 1,5 mm ²	948400
5 x 1,5 mm ²	945750
• 2 x 1,5 mm²	
HF+K3 (x1) - L562 - L1682 mm	948000
HF+K3 (x2) - L1964 - L2804 mm	948001
• 2 x 1,5 mm² + Junção 5P	
DALI+K3 (x1) - L562 - L1682 mm	948200
DALI+K3 (x2) - L1964 - L2804 mm	948201
• 2 x 1,5 mm² + 2 x 0,75 mm² + Junção 5P	
K3+TEL (x1) - L562 - L1682 mm	948100
K3+TEL (x2) - L1964 - L2804 mm	948101
Kit de união	932110
• União galvanizada, parafusos incluídos.	
Suspensão	
S5 L1500 mm (x1)	910408
S5 L1500 mm (x2)	910409
S5 L3000 mm (x1)	910419
S5 L3000 mm (x2)	910412
S5 L6000 mm (x1)	910420
S5 L6000 mm (x2)	910421
Cabo de alimentação transparente	
3 x 1,5 mm ²	94030▲
5 x 1,5 mm ²	94000▲
7 x 1,5 mm ²	94010▲
• Para a versão DALI com kit de emergência e telecomando é necessário encomendar 2 cabos de alimentação 5 x 1,5 mm ² .	
Caixa de alimentação quadrada ⁵	
Saliente T25  45 100	978610▲
Saliente T29 (DALI+K3)	978611▲
Encastrar T7  Ø70 35 90	971400▲
Encastrar T59 (DALI+K3)	971410▲
Caixa de alimentação circular ⁵	
Saliente T24  45 Ø95	978600▲
Saliente T26 (DALI+K3)	978601▲
Encastrar T5  Ø70 33 Ø90	971300▲
Encastrar T27 (DALI+K3)	978700▲
Módulo cego	
L1500 mm	992940▲
L3000 mm	992941▲
• Inclui perfil interior e tampa de encaixe em alumínio.	
Versão Low Output	
• Sob consulta.	
Projetos à medida	
• Sob consulta.	



*Substitua os símbolos para completar o código

Comprimento	▲
L1500 mm	0
L3000 mm	1
L6000 mm	2

Cor ⁵	▲
<input type="checkbox"/> Branco	W
<input type="checkbox"/> Cinzento	G
<input type="checkbox"/> Preto	B



Detalhes do produto



Perfil exterior

Perfil interior simétrico

Perfil interior assimétrico

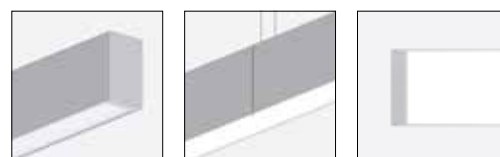

Topos sem parafusos visíveis

União sem saída de luz

Uniformidade de luz



Suspensão

Difusor clip-in

Canto horizontal



Aplicação suspensa

Difusor bGLARE

Difusor bLINE



Difusor ASYM

SwitchDIM Tunable White

Start kit



Caixas de alimentação quadradas

Caixas de alimentação circulares





REBA 50 /W

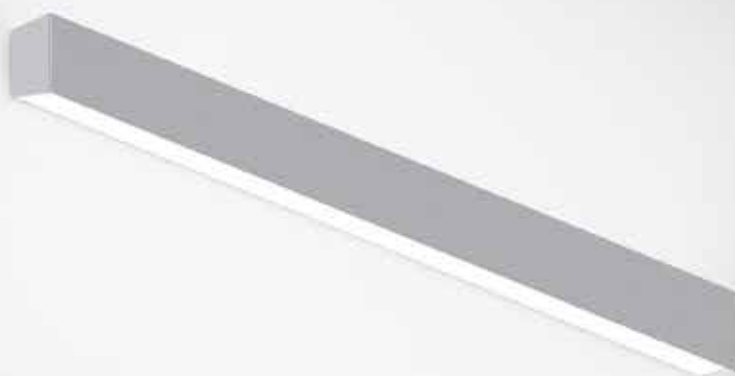

Características do produto

Corpo

Perfil de alumínio extrudido

Acabamento

Revestido a epóxi-poliéster

Sistema ótico

bLINE - Difusor opalino

Fonte de luz

LED, RG1, CRI>80, MacAdam Step ≤ 3

Vida útil LED

80.000h @ L90, B10, Ta 25°C

Fonte de alimentação

Driver LED 220-240V-50/60Hz incluído



230V/50Hz



IP 40



01. Selecionar perfil exterior

PERFIL EXTERIOR

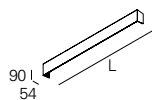

Lmm	CÓDIGO*
1128	90521L0040▲0000
1408	90521L0050▲0000
1688	90521L0060▲0000
1968	90521L0070▲0000
2248	90521L0080▲0000
2528	90521L0090▲0000
2808	90521L0100▲0000



*Substitua os símbolos para completar o código

Cor	▲
□ Branco	W
■ Cinzento	G
■ Preto	B

PERFIL EXTERIOR

• Para completar o produto é necessário encomendar o perfil interior em separado.

02. Selecionar perfil interior e difusor

PERFIL INTERIOR | DIRETO / INDIRETO

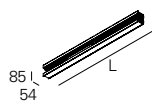

bLINE - Difusor opalino

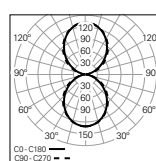

W	lm output	lm/W	Lmm	CÓDIGO*
60	6724	112	1122	90536L004▼W0♦00
70	8405	120	1402	90536L005▼W0♦00
84	10085	120	1682	90536L006▼W0♦00
104	11766	113	1962	90536L007▼W0♦00
120	13447	112	2242	90536L008▼W0♦00
130	15128	116	2522	90536L009▼W0♦00
140	16809	120	2802	90536L010▼W0♦00



*Substitua os símbolos para completar o código

Fonte de alimentação	▼
HF	E
DALI	H
HF+CD ¹	H
SWD+CD ²	Y

Emergência	●
No EM	0
EM 3h (K3) ³	3

PERFIL INTERIOR | DIRETO

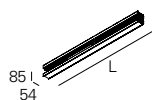

bLINE - Difusor opalino

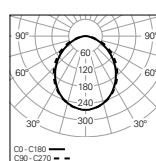

W	lm output	lm/W	Lmm	CÓDIGO*
30	3362	112	1122	90535L004▼W0♦00
35	4202	120	1402	90535L005▼W0♦00
42	5043	120	1682	90535L006▼W0♦00
52	5883	113	1962	90535L007▼W0♦00
60	6724	112	2242	90535L008▼W0♦00
65	7564	116	2522	90535L009▼W0♦00
70	8405	120	2802	90535L010▼W0♦00

Temp. de Cor	♦
3000K	3
4000K	0
Tunable White ⁴	T

PERFIL INTERIOR | INDIRETO

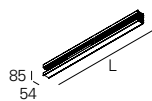

bLINE - Difusor opalino

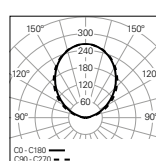

W	lm output	lm/W	Lmm	CÓDIGO*
30	3362	112	1122	90518L004▼W0♦00
35	4202	120	1402	90518L005▼W0♦00
42	5043	120	1682	90518L006▼W0♦00
52	5883	113	1962	90518L007▼W0♦00
60	6724	112	2242	90518L008▼W0♦00
65	7564	116	2522	90518L009▼W0♦00
70	8405	120	2802	90518L010▼W0♦00

¹ HF + circuito duplo.

² SwitchDIM + circuito duplo.

³ Preparado para telecomando.

⁴ Apenas disponível nas versões DALI e SWD+CD sem kit de emergência (No EM).

03. Selecionar opções

OPÇÕES	Código
<p>SwitchDIM Tunable White 926600</p> <ul style="list-style-type: none"> Nas versões Direta ou Indireta para $L \leq 1682$ mm permite controlar no máximo 20 luminárias, $L \geq 1964$ mm permite controlar no máximo 10 luminárias por cada SwitchDIM Tunable White. Nas versões Direta / Indireta para $L \leq 1682$ mm permite controlar no máximo 10 luminárias, $L \geq 1964$ mm permite controlar no máximo 5 luminárias por cada SwitchDIM Tunable White. 	
<p>Sinalética</p> <ul style="list-style-type: none"> Permite a gravação de sinais ou textos no perfil exterior. 	
<p>Versão Low Output</p> <ul style="list-style-type: none"> Sob consulta. 	



Detalhes do produto



Perfil exterior



Perfil interior



Topos sem parafusos visíveis



Uniformidade de luz visíveis



Difusor clip-in



Aplicação de parede direta / indireta



Aplicação de parede direta



Aplicação de parede indireta



Difusor bLINE



SwitchDIM Tunable White



Sinalética (sob consulta)



REBA 50 /W Line

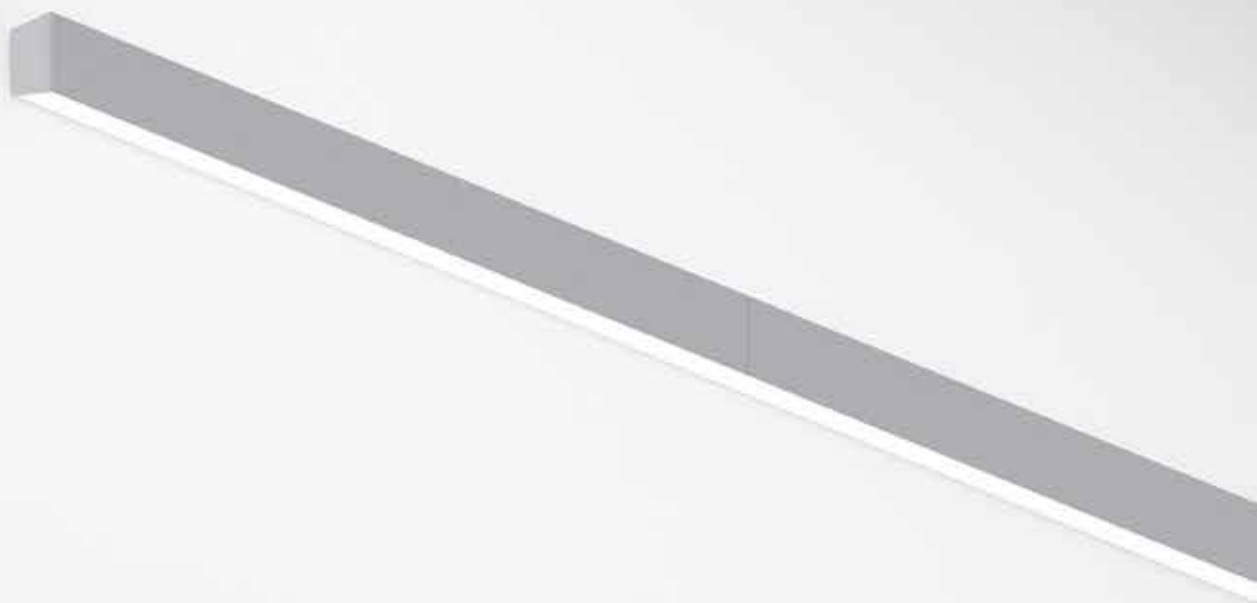

Características do produto

Corpo

Perfil de alumínio extrudido



Acabamento

Revestido a epóxi-poliéster

230V/50Hz

Sistema ótico

bLINE - Difusor opalino



IP 40

Fonte de luz

LED, RG1, CRI>80, MacAdam Step ≤3

Vida útil LED

80.000h @ L90, B10, Ta 25°C



Fonte de alimentação

Driver LED 220-240V-50/60Hz incluído

01. Seleccionar perfil exterior



PERFIL EXTERIOR

Início / Fim (SRT/END)

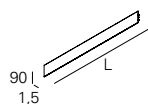

Lmm	CÓDIGO*
1125	90526L0040▲0083
1405	90526L0050▲0083
1685	90526L0060▲0083
1965	90526L0070▲0083
2245	90526L0080▲0083
2525	90526L0090▲0083
2805	90526L0100▲0083

*Substitua os símbolos para completar o código

Cor	▲
□ Branco	W
■ Cinzento	G
■ Preto	B

Intermédio (MID)

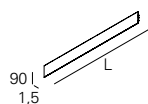

Lmm	CÓDIGO*
1122	90526L0040▲0000
1402	90526L0050▲0000
1682	90526L0060▲0000
1962	90526L0070▲0000
2242	90526L0080▲0000
2522	90526L0090▲0000
2802	90526L0100▲0000

Canto vertical (VRT)

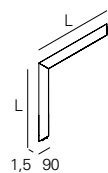

Lmm	CÓDIGO*
631	90526V0040▲0000

Esquina horizontal (EDGE)

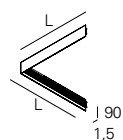

Lmm	CÓDIGO*
601	90526E0040▲0000

Canto horizontal (HRZ)

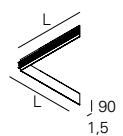

Lmm	CÓDIGO*
602	90526H0040▲0000

PERFIL EXTERIOR

- Para completar o produto é necessário encomendar o perfil interior em separado.
- Para completar a linha é necessário encomendar start kit, cablagem de linha contínua e kit de união em separado.
- O comprimento máximo da linha com um único ponto de alimentação é 30000 mm.

02. Selecionar perfil interior e difusor



PERFIL INTERIOR | DIRETO / INDIRETO

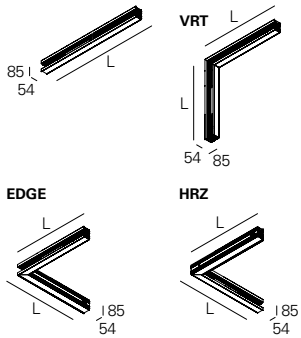

bLINE - Difusor opalino

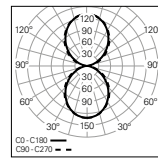

	W	lm output	lm/W	Lmm	CÓDIGO*
	60	6724	112	1122	90536L004▼W0◆00
	70	8405	120	1402	90536L005▼W0◆00
	84	10085	120	1682	90536L006▼W◆◆00
	104	11766	113	1962	90536L007▼W0◆00
	120	13447	112	2242	90536L008▼W0◆00
	130	15128	116	2522	90536L009▼W0◆00
	140	16809	120	2802	90536L010▼W0◆00
VRT	60	6724	112	631	90536V004▼W0◆00
EDGE	60	6724	112	601	90536E004▼W0◆00
HRZ	60	6724	112	602	90536H004▼W0◆00

*Substitua os símbolos para completar o código

Fonte de alimentação	
HF	E
DALI	H
HF+CD ¹	Q
SWD+CD ²	Y

Emergência	
No EM	0
EM 3h (K3) ³	3

Temp. de Cor	
3000K	3
4000K	0
Tunable White ⁴	T

PERFIL INTERIOR | DIRETO

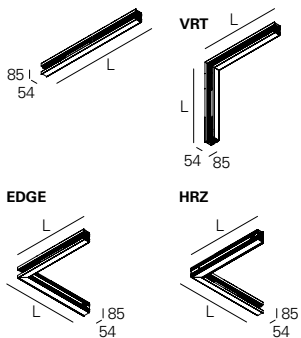

bLINE - Difusor opalino

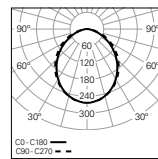

	W	lm output	lm/W	Lmm	CÓDIGO*
	30	3362	112	1122	90535L004▼W0◆00
	35	4202	120	1402	90535L005▼W◆◆00
	42	5043	120	1682	90535L006▼W◆◆00
	52	5883	113	1962	90535L007▼W◆◆00
	60	6724	112	2242	90535L008▼W◆◆00
	65	7564	116	2522	90535L009▼W◆◆00
	70	8405	120	2802	90535L010▼W◆◆00
VRT	30	3362	112	631	90535V004▼W0◆00
EDGE	30	3362	112	601	90535E004▼W0◆00
HRZ	30	3362	112	602	90535H004▼W0◆00

PERFIL INTERIOR | INDIRETO

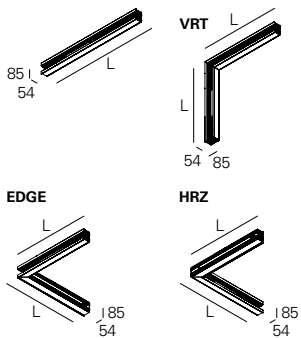

bLINE - Difusor opalino

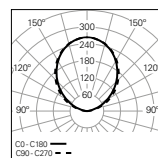

	W	lm output	lm/W	Lmm	CÓDIGO*
	30	3362	112	1122	90518L004▼W0◆00
	35	4202	120	1402	90518L005▼W0◆00
	42	5043	120	1682	90518L006▼W0◆00
	52	5883	113	1962	90518L007▼W0◆00
	60	6724	112	2242	90518L008▼W0◆00
	65	7564	116	2522	90518L009▼W0◆00
	70	8405	120	2802	90518L010▼W0◆00
VRT	30	3362	112	631	90518V004▼W0◆00
EDGE	30	3362	112	601	90518E004▼W0◆00
HRZ	30	3362	112	602	90518H004▼W0◆00

¹ HF + circuito duplo.

² SwitchDIM + circuito duplo.

³ Preparado para telecomando.

⁴ Apenas disponível nas versões DALI e SWD+CD sem kit de emergência (No EM).

03. Selecionar opções

OPÇÕES	Código*
SwitchDIM Tunable White 926600 <ul style="list-style-type: none"> Nas versões Direta ou Indireta para $L \leq 1682$ mm permite controlar no máximo 20 luminárias, $L \geq 1964$ mm permite controlar no máximo 10 luminárias por cada SwitchDIM Tunable White. Nas versões Direta / Indireta para $L \leq 1682$ mm permite controlar no máximo 10 luminárias, $L \geq 1964$ mm permite controlar no máximo 5 luminárias por cada SwitchDIM Tunable White. 	
Start kit - topo início/fim 90 52,5 3 923400♣ <ul style="list-style-type: none"> Dois topos incluídos. 	
Cablagem linha contínua <ul style="list-style-type: none"> Standard <ul style="list-style-type: none"> 3 x 1,5 mm² 945650 5 x 1,5 mm² 945750 2 x 1,5 mm² <ul style="list-style-type: none"> HF+K3 (x1) - L562 - L1682 mm 948000 HF+K3 (x2) - L1964 - L2804 mm 948001 2 x 1,5 mm² + Junção 5P <ul style="list-style-type: none"> DALI+K3 (x1) - L562 - L1682 mm 948200 DALI+K3 (x2) - L1964 - L2804 mm 948201 2 x 1,5 mm² + 2 x 0,75 mm² + Junção 5P <ul style="list-style-type: none"> K3+TEL (x1) - L562 - L1682 mm 948100 K3+TEL (x2) - L1964 - L2804 mm 948101 	
Kit de união 932120 <ul style="list-style-type: none"> União galvanizada, parafusos incluídos. 	
Módulo cego <ul style="list-style-type: none"> L1500 mm 992960♣ L3000 mm 992961♣ Inclui perfil interior e tampa de encaixe em alumínio. 	
Sinalética <ul style="list-style-type: none"> Permite a gravação de sinais ou textos no perfil exterior. 	
Versão Low Output <ul style="list-style-type: none"> Sob consulta. 	
Projetos à medida <ul style="list-style-type: none"> Sob consulta. 	



*Substitua os símbolos para completar o código

Cor	♣
□ Branco	W
■ Cinzento	G
■ Preto	B



Detalhes do produto







REBA 65

Como funciona

1. Perfil exterior

- 1.1 Encastrar
- 1.2 Trimless
- 1.3 Saliente
- 1.4 Suspensa direta
- 1.5 Suspensa direta / indireta

2. Perfil interior

- 2.1 Simétrico



- 2.2 Assimétrico



3. Difusores

- 3.1 Difusor bLINE
 - 3.2 Difusor bGLARE
 - 3.3 Tampa cega
 - 3.4 Difusor ASYM
-



77x82 mm



65x82 mm

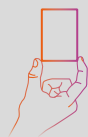

65x97 mm

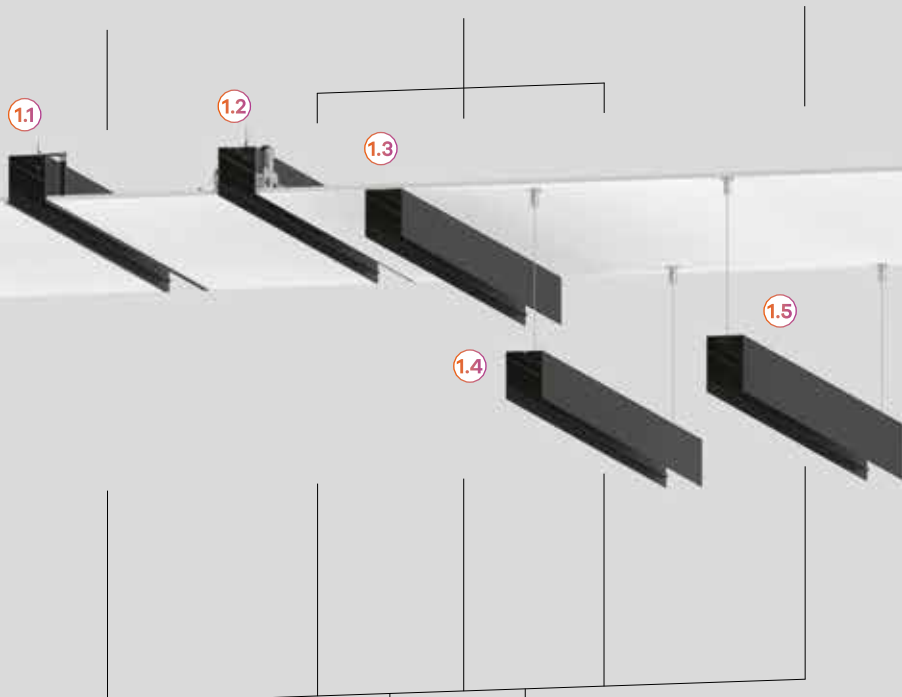

2.1

2.2



3.1

3.2

3.3

3.4







Photo: Ivo Tavares

REBA 65 /T



Características do produto

Corpo

Perfil de alumínio extrudido

Acabamento

Revestido a epóxi-poliéster

Sistema de fixação

Pré-aro trimless (incluído no perfil exterior)

Sistema ótico

bGLARE - Difusor microprismático

bLINE - Difusor opalino

ASYM - Difusor assimétrico

Fonte de luz

LED, RG1, CRI>80, MacAdam Step ≤ 3

Vida útil LED

80.000h @ L90, B10, Ta 25°C

Fonte de alimentação

Driver LED 220-240V-50/60Hz incluído

Espessura do teto

Para tetos de 10, 13, 15 e 18 mm

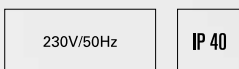

01. Selecionar perfil exterior

PERFIL EXTERIOR

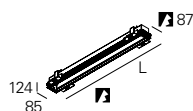

Lmm	∠	CÓDIGO*
598	600	90524L0020▲0000
878	880	90524L0030▲0000
1158	1160	90524L0040▲0000
1438	1440	90524L0050▲0000
1718	1720	90524L0060▲0000
2000	2002	90524L0070▲0000
2280	2282	90524L0080▲0000
2560	2562	90524L0090▲0000
2840	2842	90524L0100▲0000



*Substitua os símbolos para completar o código

Cor	▲
□ Branco	W
■ Cinzento	G
■ Preto	B

PERFIL EXTERIOR

• Para completar o produto é necessário encomendar o perfil interior em separado.

02. Selecionar perfil interior e difusor

PERFIL INTERIOR | SIMÉTRICO

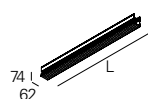

bGLARE - Difusor microprismático

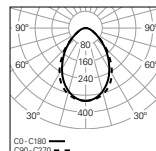

W	lm output	lm/W	Lmm	CÓDIGO*
15	1577	105	562	90502L002▼W0◆00
22	2366	108	842	90502L003▼W0◆00
30	3155	105	1122	90502L004▼W0◆00
35	3944	113	1402	90502L005▼W0◆00
42	4732	113	1682	90502L006▼W0◆00
52	5521	106	1964	90502L007▼W0◆00
60	6310	105	2244	90502L008▼W0◆00
65	7099	109	2524	90502L009▼W0◆00
70	7887	113	2804	90502L010▼W0◆00

*Substitua os símbolos para completar o código

Fonte de alimentação	▼
HF	E
DALI	H

Emergência	●
No EM	0
EM 3h (K3) ^{1 2}	3

Temp. de Cor	◆
3000K	3
4000K	0
Tunable White ³	T

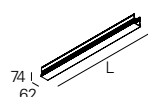

bLINE - Difusor opalino

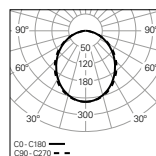

W	lm output	lm/W	Lmm	CÓDIGO*
15	1681	112	562	90501L002▼W0◆00
22	2521	115	842	90501L003▼W0◆00
30	3362	112	1122	90501L004▼W0◆00
35	4202	120	1402	90501L005▼W0◆00
42	5043	120	1682	90501L006▼W0◆00
52	5883	113	1964	90501L007▼W0◆00
60	6724	112	2244	90501L008▼W0◆00
65	7564	116	2524	90501L009▼W0◆00
70	8405	120	2804	90501L010▼W0◆00

PERFIL INTERIOR | ASSIMÉTRICO

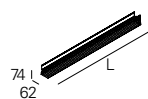

ASYM - Difusor

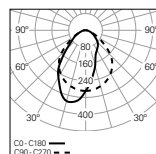

W	lm output	lm/W	Lmm	CÓDIGO*
16	1474	92	562	90504L002▼W0◆00
23	2211	96	842	90504L003▼W0◆00
29	2948	102	1122	90504L004▼W0◆00
36	3685	102	1402	90504L005▼W0◆00
44	4422	101	1682	90504L006▼W0◆00
52	5159	99	1964	90504L007▼W0◆00
58	5896	102	2244	90504L008▼W0◆00
65	6633	102	2524	90504L009▼W0◆00
73	7370	101	2804	90504L010▼W0◆00

¹ Preparado para telecomando.

² Versões DALI + EM 3h (K3) apenas disponível desde L1402 mm.

³ Apenas disponível nas versões DALI sem kit de emergência (No EM). Não disponível na versão L562 mm.

03. Selecionar opções

OPÇÕES	Código
SwitchDIM Tunable White • Para $L \leq 1682$ mm permite controlar no máximo 20 luminárias, $L \geq 1964$ mm permite controlar no máximo 10 luminárias por cada SwitchDIM Tunable White.	926600
Cabo de segurança em aço L1500 mm	955000
Versão Low Output • Sob consulta.	



Detalhes do produto



Perfil exterior



Perfil interior simétrico



Perfil interior assimétrico



Uniformidade de luz



Pré-aro trimless



Difusor clip-in

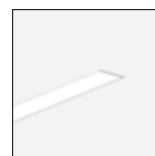

Aplicação trimless



Difusor bGLARE



Difusor bLINE



Difusor ASYM



SwitchDIM Tunable White



REBA 65 /T Line

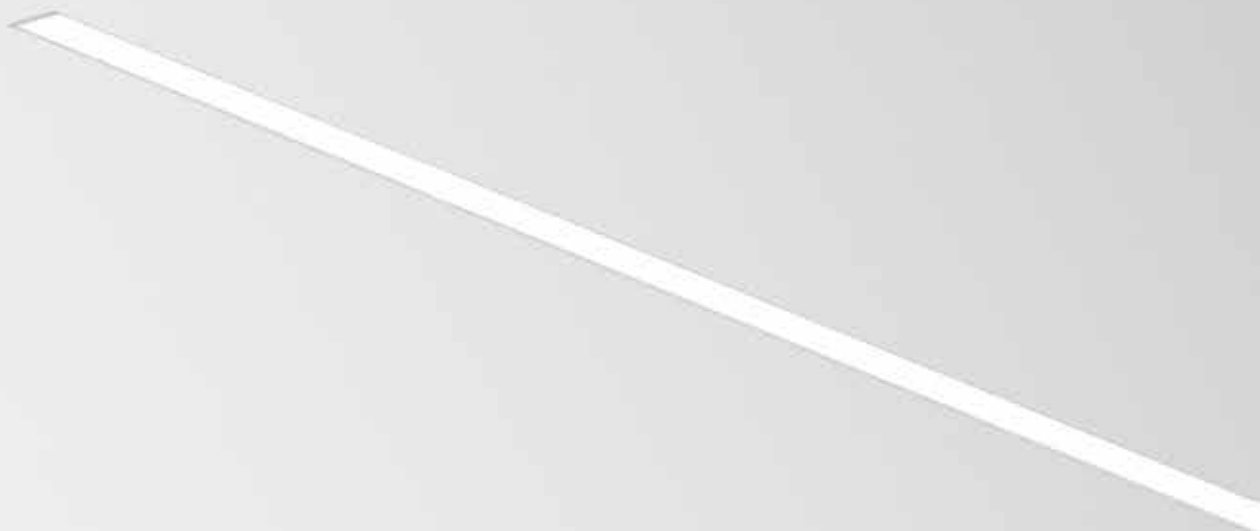

Características do produto

Corpo

Perfil de alumínio extrudido

Acabamento

Revestido a epóxi-poliéster

Sistema de fixação

Pré-aro trimless (incluído no perfil exterior)

Sistema ótico

bGLARE - Difusor microprismático

bLINE - Difusor opalino

ASYM - Difusor assimétrico

Fonte de luz

LED, RG1, CRI>80, MacAdam Step ≤ 3

Vida útil LED

80.000h @ L90, B10, Ta 25°C

Fonte de alimentação

Driver LED 220-240V-50/60Hz incluído

Espessura do teto

Para tetos de 10, 13, 15 e 18 mm

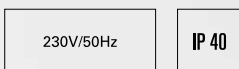

01. Selecionar perfil exterior



PERFIL EXTERIOR

Início / Fim (SRT/END)

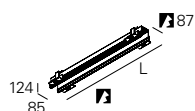

Lmm		CÓDIGO*
580	581	90511L0020▲0083
860	861	90511L0030▲0083
1140	1141	90511L0040▲0083
1420	1421	90511L0050▲0083
1700	1701	90511L0060▲0083
1982	1983	90511L0070▲0083
2262	2263	90511L0080▲0083
2542	2543	90511L0090▲0083
2822	2823	90511L0100▲0083

*Substitua os símbolos para completar o código

Cor	
□ Branco	W
■ Cinzento	G
■ Preto	B

Intermédio (MID)

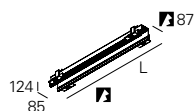

Lmm		CÓDIGO*
562	562	90511L0020▲0000
842	842	90511L0030▲0000
1122	1122	90511L0040▲0000
1402	1402	90511L0050▲0000
1682	1682	90511L0060▲0000
1964	1964	90511L0070▲0000
2244	2244	90511L0080▲0000
2524	2524	90511L0090▲0000
2804	2804	90511L0100▲0000

Canto vertical (VRT)

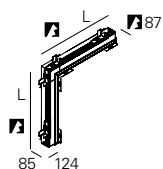

Lmm		CÓDIGO*
559	524	90511V0040▲0000

Canto horizontal (HRZ) - Esquina horizontal (EDGE)

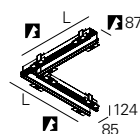

Lmm		CÓDIGO*
618	619	90511H0040▲0000

PERFIL EXTERIOR

- Para completar o produto é necessário encomendar o perfil interior em separado.
- Para completar a linha é necessário encomendar start kit, cablagem de linha contínua e kit de união em separado.
- O comprimento máximo da linha com um único ponto de alimentação é 30000 mm.

02. Seleccionar perfil interior e difusor



PERFIL INTERIOR | SIMÉTRICO

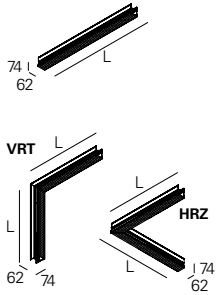

bGLARE - Difusor microprismático

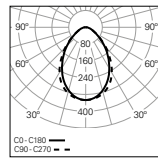

W	lm output	lm/W	Lmm	CÓDIGO*	
15	1577	105	562	90502L002♥W0♦00	
22	2366	108	842	90502L003♥W0♦00	
30	3155	105	1122	90502L004♥W♦♦00	
35	3944	113	1402	90502L005♥W♦♦00	
42	4732	113	1682	90502L006♥W♦♦00	
52	5521	106	1964	90502L007♥W♦♦00	
60	6310	105	2244	90502L008♥W♦♦00	
65	7099	109	2524	90502L009♥W♦♦00	
70	7887	113	2804	90502L010♥W♦♦00	
<hr/>					
VRT	30	3155	105	606	90502V004♥W0♦00
HRZ	30	3155	105	608	90502H004♥W0♦00

bLINE - Difusor opalino

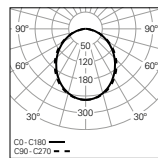

W	lm output	lm/W	Lmm	CÓDIGO*	
15	1681	112	562	90501L002♥W0♦00	
22	2521	115	842	90501L003♥W0♦00	
30	3362	112	1122	90501L004♥W♦♦00	
35	4202	120	1402	90501L005♥W♦♦00	
42	5043	120	1682	90501L006♥W♦♦00	
52	5883	113	1964	90501L007♥W♦♦00	
60	6724	112	2244	90501L008♥W♦♦00	
65	7564	116	2524	90501L009♥W♦♦00	
70	8405	120	2804	90501L010♥W♦♦00	
<hr/>					
VRT	30	3362	112	606	90501V004♥W0♦00
HRZ	30	3362	112	608	90501H004♥W0♦00

PERFIL INTERIOR | ASSIMÉTRICO

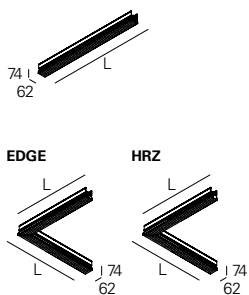

ASYM - Difusor

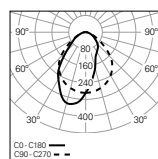

W	lm output	lm/W	Lmm	CÓDIGO*	
16	1474	92	562	90504L002♥W0♦00	
23	2211	96	842	90504L003♥W0♦00	
29	2948	102	1122	90504L004♥W♦♦00	
36	3685	102	1402	90504L005♥W♦♦00	
44	4422	101	1682	90504L006♥W♦♦00	
52	5159	99	1964	90504L007♥W♦♦00	
58	5896	102	2244	90504L008♥W♦♦00	
65	6633	102	2524	90504L009♥W♦♦00	
73	7370	101	2804	90504L010♥W♦♦00	
<hr/>					
EDGE	29	2948	102	606	90504E004♥W0♦00
HRZ	29	2948	102	608	90504H004♥W0♦00

*Substitua os símbolos para completar o código

Fonte de alimentação ♥
HF E
DALI H

Emergência ●
No EM 0
EM 3h (K3) ^{1 2} 3

Temp. de Cor ♦
3000K 3
4000K 0
Tunable White ³ T

¹ Preparado para telecomando.

² Versões DALI + EM 3h (K3) apenas disponível desde L1402 mm.

³ Apenas disponível nas versões DALI sem kit de emergência (No EM). Não disponível na versão L562 mm.

03. Selecionar opções

OPÇÕES	Código*
SwitchDIM Tunable White • Para L ≤ 1682 mm permite controlar no máximo 20 luminárias, L ≥ 1964 mm permite controlar no máximo 10 luminárias por cada SwitchDIM Tunable White.	926600
Start kit - topo início/fim • Dois topos incluídos.	821 923500♣ 65 3
Cablagem linha contínua • Standard 3 x 1,5 mm ² 5 x 1,5 mm ²	945650 945750
• 2 x 1,5 mm² HF+K3 (x1) - L562 - L1682 mm HF+K3 (x2) - L1964 - L2804 mm	948000 948001
• 2 x 1,5 mm² + Junção 5P DALI+K3 (x1) - L562 - L1682 mm DALI+K3 (x2) - L1964 - L2804 mm	948200 948201
• 2 x 1,5 mm² + 2 x 0,75 mm² + Junção 5P K3+TEL (x1) - L562 - L1682 mm K3+TEL (x2) - L1964 - L2804 mm	948100 948101
Kit de união • União galvanizada, parafusos incluídos.	932220
Módulo cego L1500 mm L3000 mm • Inclui perfil interior e tampa de encaixe em alumínio.	993060♣ 993061♣
Cabo de segurança em aço L1500 mm	955000
Versão Low Output • Sob consulta.	
Projetos à medida • Sob consulta.	



*Substitua os símbolos para completar o código

Cor	♣
□ Branco	W
■ Cinzento	G
■ Preto	B



Detalhes do produto



Perfil exterior



Perfil interior simétrico

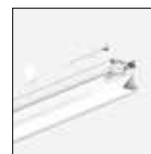

Perfil interior assimétrico



Uniformidade de luz

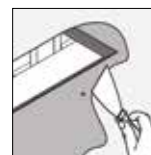

Pré-aro trimless



Difusor clip-in



Canto vertical



Canto horizontal



Aplicação trimless



Difusor bGLARE



Difusor bLINE



Difusor ASYM



SwitchDIM Tunable White



Start kit



Photo: Ivo Tavares



Photo Ivo Tavares

REBA 65 /E



Características do produto

Corpo

Perfil de alumínio extrudido

Acabamento

Revestido a epóxi-poliéster

Sistema de fixação

Niveladores

Sistema ótico

bGLARE - Difusor microprismático

bLINE - Difusor opalino

ASYM - Difusor assimétrico

Fonte de luz

LED, RG1, CRI>80, MacAdam Step ≤ 3

Vida útil LED

80.000h @ L90, B10, Ta 25°C

Fonte de alimentação

Driver LED 220-240V-50/60Hz incluído

Espessura do teto

Para tetos entre 1-25 mm

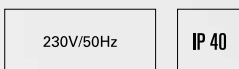

01. Selecionar perfil exterior

PERFIL EXTERIOR

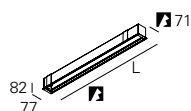

Lmm	f3	CÓDIGO*
590	580	90525L0020▲0000
870	860	90525L0030▲0000
1150	1140	90525L0040▲0000
1430	1420	90525L0050▲0000
1710	1700	90525L0060▲0000
1992	1982	90525L0070▲0000
2272	2262	90525L0080▲0000
2552	2542	90525L0090▲0000
2832	2822	90525L0100▲0000



*Substitua os símbolos para completar o código

Cor	▲
□ Branco	W
■ Cinzento	G
■ Preto	B

PERFIL EXTERIOR

• Para completar o produto é necessário encomendar o perfil interior em separado.

02. Selecionar perfil interior e difusor

PERFIL INTERIOR | SIMÉTRICO

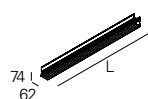

bGLARE - Difusor microprismático

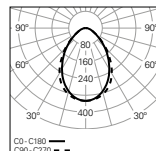

W	lm output	lm/W	Lmm	CÓDIGO*
15	1577	105	562	90502L002▼W0◆00
22	2366	108	842	90502L003▼W0◆00
30	3155	105	1122	90502L004▼W0◆00
35	3944	113	1402	90502L005▼W0◆00
42	4732	113	1682	90502L006▼W0◆00
52	5521	106	1964	90502L007▼W0◆00
60	6310	105	2244	90502L008▼W0◆00
65	7099	109	2524	90502L009▼W0◆00
70	7887	113	2804	90502L010▼W0◆00

*Substitua os símbolos para completar o código

Fonte de alimentação	▼
HF	E
DALI	H

Emergência	●
No EM	0
EM 3h (K3) ^{1 2}	3

Temp. de Cor	◆
3000K	3
4000K	0
Tunable White ³	T

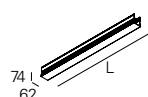

bLINE - Difusor opalino

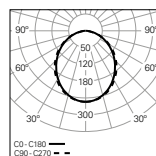

W	lm output	lm/W	Lmm	CÓDIGO*
15	1681	112	562	90501L002▼W0◆00
22	2521	115	842	90501L003▼W0◆00
30	3362	112	1122	90501L004▼W0◆00
35	4202	120	1402	90501L005▼W0◆00
42	5043	120	1682	90501L006▼W0◆00
52	5883	113	1964	90501L007▼W0◆00
60	6724	112	2244	90501L008▼W0◆00
65	7564	116	2524	90501L009▼W0◆00
70	8405	120	2804	90501L010▼W0◆00

PERFIL INTERIOR | ASSIMÉTRICO

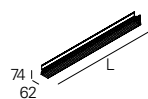

ASYM - Difusor

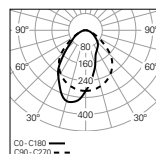

W	lm output	lm/W	Lmm	CÓDIGO*
16	1474	92	562	90504L002▼W0◆00
23	2211	96	842	90504L003▼W0◆00
29	2948	102	1122	90504L004▼W0◆00
36	3685	102	1402	90504L005▼W0◆00
44	4422	101	1682	90504L006▼W0◆00
52	5159	99	1964	90504L007▼W0◆00
58	5896	102	2244	90504L008▼W0◆00
65	6633	102	2524	90504L009▼W0◆00
73	7370	101	2804	90504L010▼W0◆00

¹ Preparado para telecomando.

² Versões DALI + EM 3h (K3) apenas disponível desde L1402 mm.

³ Apenas disponível nas versões DALI sem kit de emergência (No EM). Não disponível na versão L562 mm.

03. Selecionar opções

OPÇÕES	Código
SwitchDIM Tunable White • Para $L \leq 1682$ mm permite controlar no máximo 20 luminárias, $L \geq 1964$ mm permite controlar no máximo 10 luminárias por cada SwitchDIM Tunable White.	926600
Cabo de segurança em aço L1500 mm	955000
Versão Low Output • Sob consulta.	



Detalhes do produto



Perfil exterior



Nivelador



Perfil interior simétrico

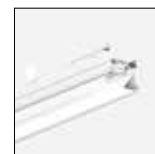

Perfil interior assimétrico



Uniformidade de luz



Difusor clip-in



Aplicação de encastrar



Difusor bGLARE



Difusor bLINE



Difusor ASYM



SwitchDIM
Tunable White



REBA 65 /E Line

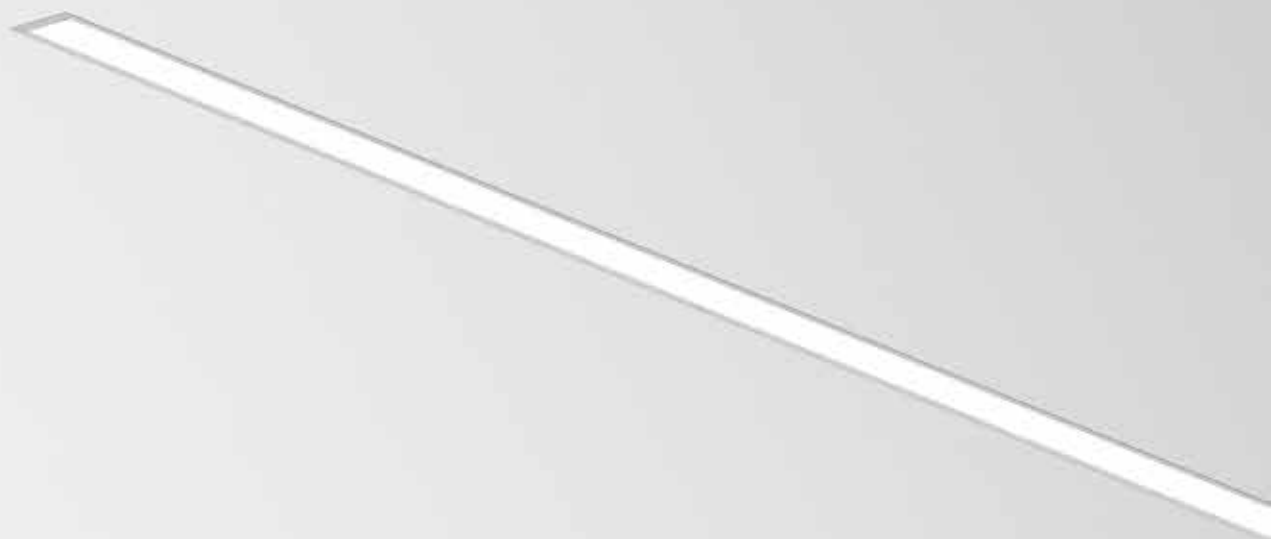

Características do produto

Corpo

Perfil de alumínio extrudido

Acabamento

Revestido a epóxi-poliéster

Sistema de fixação

Niveladores

Sistema ótico

bGLARE - Difusor microprismático

bLINE - Difusor opalino

ASYM - Difusor assimétrico

Fonte de luz

LED, RG1, CRI>80, MacAdam Step ≤ 3

Vida útil LED

80.000h @ L90, B10, Ta 25°C

Fonte de alimentação

Driver LED 220-240V-50/60Hz incluído

Espessura do teto

Para tetos entre 1-25 mm

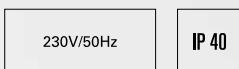

01. Selecionar perfil exterior



PERFIL EXTERIOR

Início / Fim (SRT/END)

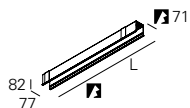

Lmm		CÓDIGO*
567	568	90510L0020▲0083
847	848	90510L0030▲0083
1127	1128	90510L0040▲0083
1407	1408	90510L0050▲0083
1687	1688	90510L0060▲0083
1969	1970	90510L0070▲0083
2249	2250	90510L0080▲0083
2529	2530	90510L0090▲0083
2809	2810	90510L0100▲0083

*Substitua os símbolos para completar o código

Cor	▲
<input type="checkbox"/> Branco	W
<input type="checkbox"/> Cinzento	G
<input type="checkbox"/> Preto	B

Intermédio (MID)

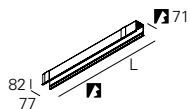

Lmm		CÓDIGO*
562	562	90510L0020▲0000
842	842	90510L0030▲0000
1122	1122	90510L0040▲0000
1402	1402	90510L0050▲0000
1682	1682	90510L0060▲0000
1964	1964	90510L0070▲0000
2244	2244	90510L0080▲0000
2524	2524	90510L0090▲0000
2804	2804	90510L0100▲0000

Canto vertical (VRT)

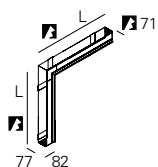

Lmm		CÓDIGO*
606	526	90510V0040▲0000

Canto horizontal (HRZ) - Esquina horizontal (EDGE)

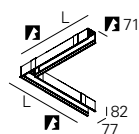

Lmm		CÓDIGO*
614	611	90510H0040▲0000

PERFIL EXTERIOR

- Para completar o produto é necessário encomendar o perfil interior em separado.
- Para completar a linha é necessário encomendar start kit, cablagem de linha contínua e kit de união em separado.
- Dimensões não incluem start kit. Adicione 6 mm ao comprimento de corte para completar a dimensão de encaixe da linha.
- O comprimento máximo da linha com um único ponto de alimentação é 30000 mm.

02. Selecionar perfil interior e difusor



PERFIL INTERIOR | SIMÉTRICO

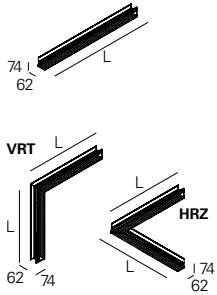

bGLARE - Difusor microprismático

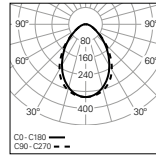

W	lm output	lm/W	Lmm	CÓDIGO*	
15	1577	105	562	90502L002♥W0♦00	
22	2366	108	842	90502L003♥W0♦00	
30	3155	105	1122	90502L004♥W♦♦00	
35	3944	113	1402	90502L005♥W♦♦00	
42	4732	113	1682	90502L006♥W♦♦00	
52	5521	106	1964	90502L007♥W♦♦00	
60	6310	105	2244	90502L008♥W♦♦00	
65	7099	109	2524	90502L009♥W♦♦00	
70	7887	113	2804	90502L010♥W♦♦00	
<hr/>					
VRT	30	3155	105	606	90502V004♥W0♦00
HRZ	30	3155	105	608	90502H004♥W0♦00

bLINE - Difusor opalino

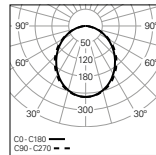

W	lm output	lm/W	Lmm	CÓDIGO*	
15	1681	112	562	90501L002♥W0♦00	
22	2521	115	842	90501L003♥W0♦00	
30	3362	112	1122	90501L004♥W♦♦00	
35	4202	120	1402	90501L005♥W♦♦00	
42	5043	120	1682	90501L006♥W♦♦00	
52	5883	113	1964	90501L007♥W♦♦00	
60	6724	112	2244	90501L008♥W♦♦00	
65	7564	116	2524	90501L009♥W♦♦00	
70	8405	120	2804	90501L010♥W♦♦00	
<hr/>					
VRT	30	3362	112	606	90501V004♥W0♦00
HRZ	30	3362	112	608	90501H004♥W0♦00

PERFIL INTERIOR | ASSIMÉTRICO

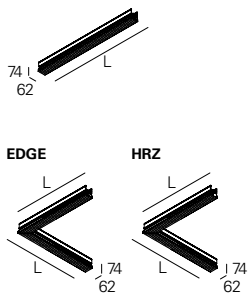

ASYM - Difusor

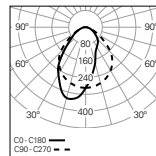

W	lm output	lm/W	Lmm	CÓDIGO*	
16	1474	92	562	90504L002♥W0♦00	
23	2211	96	842	90504L003♥W0♦00	
29	2948	102	1122	90504L004♥W♦♦00	
36	3685	102	1402	90504L005♥W♦♦00	
44	4422	101	1682	90504L006♥W♦♦00	
52	5159	99	1964	90504L007♥W♦♦00	
58	5896	102	2244	90504L008♥W♦♦00	
65	6633	102	2524	90504L009♥W♦♦00	
73	7370	101	2804	90504L010♥W♦♦00	
<hr/>					
EDGE	29	2948	102	606	90504E004♥W0♦00
HRZ	29	2948	102	608	90504H004♥W0♦00

*Substitua os símbolos para completar o código

Fonte de alimentação ♥
HF E
DALI H

Emergência ●
No EM 0
EM 3h (K3) ^{1 2} 3

Temp. de Cor ♦
3000K 3
4000K 0
Tunable White ³ T

¹ Preparado para telecomando.

² Versões DALI + EM 3h (K3) apenas disponível desde L1402 mm.

³ Apenas disponível nas versões DALI sem kit de emergência (No EM). Não disponível na versão L562 mm.

03. Selecionar opções

OPÇÕES	Código*
SwitchDIM Tunable White • Para L ≤ 1682 mm permite controlar no máximo 20 luminárias, L ≥ 1964 mm permite controlar no máximo 10 luminárias por cada SwitchDIM Tunable White.	926600
Start kit - topo início/fim • Dois topos incluídos.	82 923600♣ 77 9
Cablagem linha contínua • Standard 3 x 1,5 mm ² 5 x 1,5 mm ²	945650 945750
• 2 x 1,5 mm² HF+K3 (x1) - L562 - L1682 mm HF+K3 (x2) - L1964 - L2804 mm	948000 948001
• 2 x 1,5 mm² + Junção 5P DALI+K3 (x1) - L562 - L1682 mm DALI+K3 (x2) - L1964 - L2804 mm	948200 948201
• 2 x 1,5 mm² + 2 x 0,75 mm² + Junção 5P K3+TEL (x1) - L562 - L1682 mm K3+TEL (x2) - L1964 - L2804 mm	948100 948101
Kit de união • União galvanizada, parafusos incluídos.	932200
Módulo cego L1500 mm L3000 mm • Inclui perfil interior e tampa de encaixe em alumínio.	993020♣ 993021♣
Cabo de segurança em aço L1500 mm	955000
Versão Low Output • Sob consulta.	
Projetos à medida • Sob consulta.	



*Substitua os símbolos para completar o código

Cor	♣
□ Branco	W
■ Cinzento	G
■ Preto	B



Detalhes do produto



Perfil exterior



Perfil interior simétrico



Perfil interior assimétrico

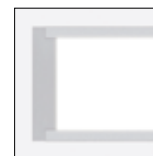

Uniformidade de luz



Nivelador



Difusor clip-in



Canto vertical



Canto horizontal



Aplicação de encastrar



Difusor bGLARE



Difusor bLINE



Difusor ASYM



SwitchDIM Tunable White



Start kit





REBA 65



Características do produto

Corpo

Perfil de alumínio extrudido

Acabamento

Revestido a epóxi-poliéster

Sistema ótico

bGLARE - Difusor microprismático

bLINE - Difusor opalino

ASYM - Difusor assimétrico

Fonte de luz

LED, RG1, CRI>80, MacAdam Step ≤ 3

Vida útil LED

80.000h @ L90, B10, Ta 25°C

Fonte de alimentação

Driver LED 220-240V-50/60Hz incluído



01. Seleccionar perfil exterior

PERFIL EXTERIOR

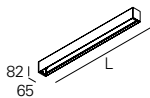

Lmm	CÓDIGO*
578	90522L0020♣0000
858	90522L0030♣0000
1138	90522L0040♣0000
1418	90522L0050♣0000
1698	90522L0060♣0000
1980	90522L0070♣0000
2260	90522L0080♣0000
2540	90522L0090♣0000
2820	90522L0100♣0000



*Substitua os símbolos para completar o código

Cor	♣
□ Branco	W
■ Cinzento	G
■ Preto	B

PERFIL EXTERIOR

- Para completar o produto é necessário encomendar o perfil interior em separado.
- Para versão suspensa é necessário encomendar suspensão, cabo e caixa de alimentação em separado.

02. Seleccionar perfil interior e difusor

PERFIL INTERIOR | SIMÉTRICO

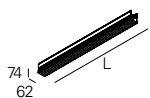

bGLARE - Difusor microprismático

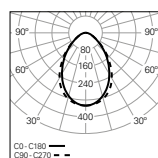

W	lm output	lm/W	Lmm	CÓDIGO*
15	1577	105	562	90502L002♥W0♦00
22	2366	108	842	90502L003♥W0♦00
30	3155	105	1122	90502L004♥W♦♦00
35	3944	113	1402	90502L005♥W♦♦00
42	4732	113	1682	90502L006♥W♦♦00
52	5521	106	1964	90502L007♥W♦♦00
60	6310	105	2244	90502L008♥W♦♦00
65	7099	109	2524	90502L009♥W♦♦00
70	7887	113	2804	90502L010♥W♦♦00

*Substitua os símbolos para completar o código

Fonte de alimentação	♥
HF	E
DALI	H

Emergência	●
No EM	0
EM 3h (K3) ^{1,2}	3

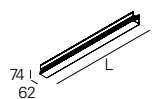

bLINE - Difusor opalino

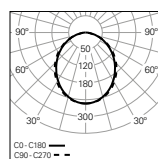

W	lm output	lm/W	Lmm	CÓDIGO*
15	1681	112	562	90501L002♥W0♦00
22	2521	115	842	90501L003♥W0♦00
30	3362	112	1122	90501L004♥W♦♦00
35	4202	120	1402	90501L005♥W♦♦00
42	5043	120	1682	90501L006♥W♦♦00
52	5883	113	1964	90501L007♥W♦♦00
60	6724	112	2244	90501L008♥W♦♦00
65	7564	116	2524	90501L009♥W♦♦00
70	8405	120	2804	90501L010♥W♦♦00

Temp. de Cor	♦
3000K	3
4000K	0
Tunable White ³	T

PERFIL INTERIOR | ASSIMÉTRICO

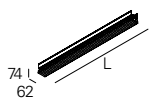

ASYM - Difusor

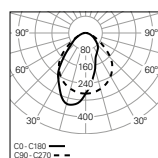

















W	lm output	lm/W	Lmm	CÓDIGO*
16	1474	92	562	90504L002♥W0♦00
23	2211	96	842	90504L003♥W0♦00
29	2948	102	1122	90504L004♥W♦♦00
36	3685	102	1402	90504L005♥W♦♦00
44	4422	101	1682	90504L006♥W♦♦00
52	5159	99	1964	90504L007♥W♦♦00
58	5896	102	2244	90504L008♥W♦♦00
65	6633	102	2524	90504L009♥W♦♦00
73	7370	101	2804	90504L010♥W♦♦00

¹ Preparado para telecomando.

² Versões DALI + EM 3h (K3) apenas disponível desde L1402 mm.

³ Apenas disponível nas versões DALI sem kit de emergência (No EM). Não disponível na versão L562 mm.

03. Selecionar opções

OPÇÕES	Código*
SwitchDIM Tunable White	926600
<ul style="list-style-type: none"> • Para $L \leq 1682$ mm permite controlar no máximo 20 luminárias, $L \geq 1964$ mm permite controlar no máximo 10 luminárias por cada SwitchDIM Tunable White. 	
Suspensão	
S5 L1500 mm (x1)	910408
S5 L1500 mm (x2)	910409
S5 L3000 mm (x1)	910419
S5 L3000 mm (x2)	910412
S5 L6000 mm (x1)	910420
S5 L6000 mm (x2)	910421
Cabo de alimentação transparente	
L1500 mm - 3 x 0,75 mm ²	940400
L1500 mm - 5 x 0,75 mm ²	940500
L1500 mm - 7 x 0,75 mm ²	940600
L3000 mm - 3 x 0,75 mm ²	940401
L3000 mm - 5 x 0,75 mm ²	940501
L3000 mm - 7 x 0,75 mm ²	940601
L6000 mm - 3 x 0,75 mm ²	940402
L6000 mm - 5 x 0,75 mm ²	940507
L6000 mm - 7 x 0,75 mm ²	940602
<ul style="list-style-type: none"> • Para a versão DALI com kit de emergência e telecomando é necessário encomendar 2 cabos de alimentação 5 x 0,75 mm². 	
Caixa de alimentação quadrada	
Saliente T25  45 l  100	978610 
Saliente T29 (DALI+K3)	978611 
Encastrar T7  Ø70 35 l  90	971400 
Encastrar T59 (DALI+K3)	971410 
Caixa de alimentação circular	
Saliente T24  45 l  Ø95	978600 
Saliente T26 (DALI+K3)	978601 
Encastrar T5  Ø70 33 l  Ø90	971300 
Encastrar T27 (DALI+K3)	978700 
Versão Low Output	
<ul style="list-style-type: none"> • Sob consulta. 	



*Substitua os símbolos para completar o código

Cor 

Branco W

Preto B



Detalhes do produto





Architects: Gleason
Photo: António Chaves

REBA 65 Line



Características do produto

Corpo

Perfil de alumínio extrudido

Acabamento

Revestido a epóxi-poliéster

Sistema ótico

bGLARE - Difusor microprismático

bLINE - Difusor opalino

ASYM - Difusor assimétrico

Fonte de luz

LED, RG1, CRI>80, MacAdam Step ≤ 3

Vida útil LED

80.000h @ L90, B10, Ta 25°C

Fonte de alimentação

Driver LED 220-240V-50/60Hz incluído

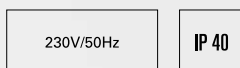

01. Seleccionar perfil exterior



PERFIL EXTERIOR

Início / Fim (SRT/END)

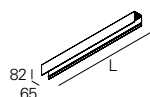

Lmm	CÓDIGO*
567	90509L0020▲0083
847	90509L0030▲0083
1127	90509L0040▲0083
1407	90509L0050▲0083
1687	90509L0060▲0083
1969	90509L0070▲0083
2249	90509L0080▲0083
2529	90509L0090▲0083
2809	90509L0100▲0083

*Substitua os símbolos para completar o código

Cor	▲
□ Branco	W
■ Cinzento	G
■ Preto	B

Intermédio (MID)

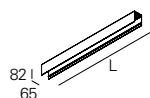

Lmm	CÓDIGO*
562	90509L0020▲0000
842	90509L0030▲0000
1122	90509L0040▲0000
1402	90509L0050▲0000
1682	90509L0060▲0000
1964	90509L0070▲0000
2244	90509L0080▲0000
2524	90509L0090▲0000
2804	90509L0100▲0000

Canto vertical (VRT)

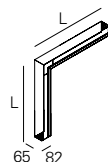

Lmm	CÓDIGO*
606	90509V0040▲0000

Canto horizontal (HRZ) - Esquina horizontal (EDGE)

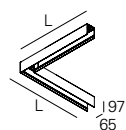

Lmm	CÓDIGO*
608	90509H0040▲0000

PERFIL EXTERIOR

- Para completar o produto é necessário encomendar o perfil interior em separado.
- Para versão suspensa é necessário encomendar suspensão, cabo e caixa de alimentação em separado.
- Para completar a linha é necessário encomendar start kit, cablagem de linha contínua e kit de união em separado.
- As dimensões não incluem start kit. Adicione 6 mm ao comprimento para completar a linha.
- O comprimento máximo da linha com um único ponto de alimentação é 30000 mm.

02. Selecionar perfil interior e difusor



PERFIL INTERIOR | SIMÉTRICO

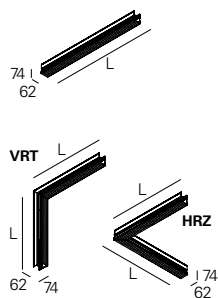

bGLARE - Difusor microprismático

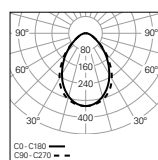

W	lm output	lm/W	Lmm	CÓDIGO*	
15	1577	105	562	90502L002♥W0♦00	
22	2366	108	842	90502L003♥W0♦00	
30	3155	105	1122	90502L004♥W♦♦00	
35	3944	113	1402	90502L005♥W♦♦00	
42	4732	113	1682	90502L006♥W♦♦00	
52	5521	106	1964	90502L007♥W♦♦00	
60	6310	105	2244	90502L008♥W♦♦00	
65	7099	109	2524	90502L009♥W♦♦00	
70	7887	113	2804	90502L010♥W♦♦00	
<hr/>					
VRT	30	3155	105	606	90502V004♥W0♦00
HRZ	30	3155	105	608	90502H004♥W0♦00

bLINE - Difusor opalino

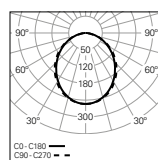

W	lm output	lm/W	Lmm	CÓDIGO*	
15	1681	112	562	90501L002♥W0♦00	
22	2521	115	842	90501L003♥W0♦00	
30	3362	112	1122	90501L004♥W♦♦00	
35	4202	120	1402	90501L005♥W♦♦00	
42	5043	120	1682	90501L006♥W♦♦00	
52	5883	113	1964	90501L007♥W♦♦00	
60	6724	112	2244	90501L008♥W♦♦00	
65	7564	116	2524	90501L009♥W♦♦00	
70	8405	120	2804	90501L010♥W♦♦00	
<hr/>					
VRT	30	3362	112	606	90501V004♥W0♦00
HRZ	30	3362	112	608	90501H004♥W0♦00

PERFIL INTERIOR | ASSIMÉTRICO

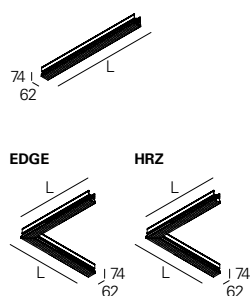

ASYM - Difusor

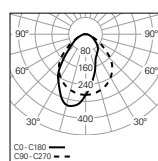

W	lm output	lm/W	Lmm	CÓDIGO*	
16	1474	92	562	90504L002♥W0♦00	
23	2211	96	842	90504L003♥W0♦00	
29	2948	102	1122	90504L004♥W♦♦00	
36	3685	102	1402	90504L005♥W♦♦00	
44	4422	101	1682	90504L006♥W♦♦00	
52	5159	99	1964	90504L007♥W♦♦00	
58	5896	102	2244	90504L008♥W♦♦00	
65	6633	102	2524	90504L009♥W♦♦00	
73	7370	101	2804	90504L010♥W♦♦00	
<hr/>					
EDGE	29	2948	102	606	90504E004♥W0♦00
HRZ	29	2948	102	608	90504H004♥W0♦00

*Substitua os símbolos para completar o código

Fonte de alimentação ♥
HF E
DALI H

Emergência ●
No EM 0
EM 3h (K3) ^{1 2} 3

Temp. de Cor ♦
3000K 3
4000K 0
Tunable White ³ T

¹ Preparado para telecomando.

² Versões DALI + EM 3h (K3) apenas disponível desde L1402 mm.

³ Apenas disponível nas versões DALI sem kit de emergência (No EM). Não disponível na versão L562 mm.

03. Selecionar opções

OPÇÕES	Código*
SwitchDIM Tunable White	926600
• Para L ≤ 1682 mm permite controlar no máximo 20 luminárias, L ≥ 1964 mm permite controlar no máximo 10 luminárias por cada SwitchDIM Tunable White.	
Start kit - topo início/fim	923500▲
• Dois topos incluídos.	
Cablagem linha contínua	
• Standard	
3 x 1,5 mm ²	945650
5 x 1,5 mm ²	945750
• 2 x 1,5 mm²	
HF+K3 (x1) - L562 - L1682 mm	948000
HF+K3 (x2) - L1964 - L2804 mm	948001
• 2 x 1,5 mm² + Junção 5P	
DALI+K3 (x1) - L562 - L1682 mm	948200
DALI+K3 (x2) - L1964 - L2804 mm	948201
• 2 x 1,5 mm² + 2 x 0,75 mm² + Junção 5P	
K3+TEL (x1) - L562 - L1682 mm	948100
K3+TEL (x2) - L1964 - L2804 mm	948101
Kit de união	932200
• União galvanizada, parafusos incluídos.	
Suspensão	
S5 L1500 mm (x1)	910408
S5 L1500 mm (x2)	910409
S5 L3000 mm (x1)	910419
S5 L3000 mm (x2)	910412
S5 L6000 mm (x1)	910420
S5 L6000 mm (x2)	910421
Cabo de alimentação transparente	
3 x 1,5 mm ²	94030▲
5 x 1,5 mm ²	94000▲
7 x 1,5 mm ²	94010▲
• Para a versão DALI com kit de emergência e telecomando é necessário encomendar 2 cabos de alimentação 5 x 1,5 mm ² .	
Caixa de alimentação quadrada³	
Saliente T25	45 100 978610▲
Saliente T29 (DALI+K3)	978611▲
Encastrar T7	Ø70 35 90 971400▲
Encastrar T59 (DALI+K3)	971410▲
Caixa de alimentação circular³	
Saliente T24	45 Ø95 978600▲
Saliente T26 (DALI+K3)	978601▲
Encastrar T5	Ø70 33 Ø90 971300▲
Encastrar T27 (DALI+K3)	978700▲
Módulo cego	
L1500 mm	993000▲
L3000 mm	993001▲
• Inclui perfil interior e tampa de encaixe em alumínio.	
Versão Low Output	
• Sob consulta.	
Projetos à medida	
• Sob consulta.	



*Substitua os símbolos para completar o código

Comprimento	▲
L1500 mm	0
L3000 mm	1
L6000 mm	2

Cor ³	▲
□ Branco	W
■ Cinzento	G
■ Preto	B



Detalhes do produto



Perfil exterior

Perfil interior simétrico

Perfil interior assimétrico

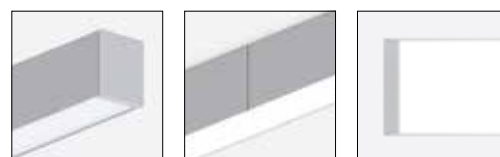

Topos sem parafusos visíveis

União sem saída de luz

Uniformidade de luz



Suspensão

Difusor clip-in

Canto vertical

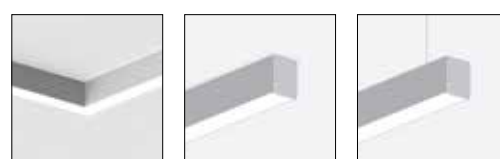

Canto horizontal

Aplicação saliente

Aplicação suspensa



Difusor bGLARE

Difusor bLINE

Difusor ASYM



SwitchDIM Tunable White

Start kit

Caixas de alimentação quadradas



Caixas de alimentação circulares

³ As caixas de alimentação apenas estão disponíveis na cor branca ou preta.





REBA 65 D/I



Características do produto

Corpo

Perfil de alumínio extrudido

Acabamento

Revestido a epóxi-poliéster

Sistema ótico

bGLARE - Difusor microprismático

bLINE - Difusor opalino

ASYM - Difusor assimétrico

Fonte de luz

LED, RG1, CRI>80, MacAdam Step ≤ 3

Vida útil LED

80.000h @ L90, B10, Ta 25°C

Fonte de alimentação

Driver LED 220-240V-50/60Hz incluído



230V/50Hz

IP 40

ASYM
850°C

bGLARE
850°C

bLINE
960°C

01. Seleccionar perfil exterior

PERFIL EXTERIOR

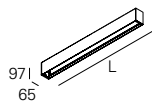

Lmm	CÓDIGO*
1138	90537L0040▲0000
1418	90537L0050▲0000
1698	90537L0060▲0000
2260	90537L0080▲0000
2540	90537L0090▲0000
2820	90537L0100▲0000



*Substitua os símbolos para completar o código

Cor	▲
□ Branco	W
■ Cinzento	G
■ Preto	B

PERFIL EXTERIOR

- Difusor da parte indireta incluído no produto.
- Para completar o produto é necessário encomendar o perfil interior, suspensão, cabo e caixa de alimentação em separado.

02. Seleccionar perfil interior e difusor

PERFIL INTERIOR | SIMÉTRICO

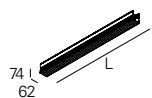

bGLARE - Difusor micropismático (60%/40%)

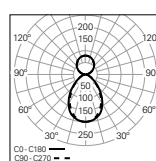

W	lm output	lm/W	Lmm	CÓDIGO*
52	5250	101	1122	90532L004▼W0♦00
65	6749	104	1402	90532L005▼W0♦00
77	8249	107	1682	90532L006▼W0♦00
102	10499	103	2244	90532L008▼W0♦00
117	11999	103	2524	90532L009▼W0♦00
130	13499	104	2804	90532L010▼W0♦00

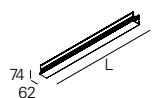

bLINE - Difusor opalino (60%/40%)

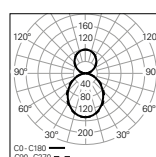

W	lm output	lm/W	Lmm	CÓDIGO*
52	5340	103	1122	90531L004▼W0♦00
65	6866	106	1402	90531L005▼W0♦00
77	8392	109	1682	90531L006▼W0♦00
102	10680	105	2244	90531L008▼W0♦00
117	12206	104	2524	90531L009▼W0♦00
130	13732	106	2804	90531L010▼W0♦00



*Substitua os símbolos para completar o código

Fonte de alimentação	▼
HF	E
DALI	H
HF+CD ¹	Q
SWD+CD ²	Y

Emergência	●
No EM	0
EM 3h (K3) ³	3

Temp. de Cor	◆
3000K	3
4000K	0
Tunable White ⁴	T

PERFIL INTERIOR | ASSIMÉTRICO

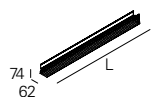

ASYM - Difusor (60%/40%)

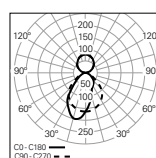

W	lm output	lm/W	Lmm	CÓDIGO*
51	4888	96	1122	90534L004▼W0♦00
66	6284	95	1402	90534L005▼W0♦00
79	7680	97	1682	90534L006▼W0♦00
100	9775	98	2244	90534L008▼W0♦00
117	11172	95	2524	90534L009▼W0♦00
133	12568	94	2804	90534L010▼W0♦00









¹ HF + circuito duplo.

² SwitchDIM + circuito duplo.

³ Preparado para telecomando.

⁴ Apenas disponível nas versões DALI e SWD+CD sem kit de emergência (No EM).

03. Selecionar opções

OPÇÕES	Código*
SwitchDIM Tunable White	926600
<ul style="list-style-type: none"> • Para $L \leq 1682$ mm permite controlar no máximo 10 luminárias, $L \geq 1964$ mm permite controlar no máximo 5 luminárias por cada SwitchDIM Tunable White. 	
Suspensão	
S5 L1500 mm (x1)	910408
S5 L1500 mm (x2)	910409
S5 L3000 mm (x1)	910419
S5 L3000 mm (x2)	910412
S5 L6000 mm (x1)	910420
S5 L6000 mm (x2)	910421
Cabo de alimentação transparente	
L1500 mm - 3 x 0,75 mm ²	940400
L1500 mm - 5 x 0,75 mm ²	940500
L1500 mm - 7 x 0,75 mm ²	940600
L3000 mm - 3 x 0,75 mm ²	940401
L3000 mm - 5 x 0,75 mm ²	940501
L3000 mm - 7 x 0,75 mm ²	940601
L6000 mm - 3 x 0,75 mm ²	940402
L6000 mm - 5 x 0,75 mm ²	940507
L6000 mm - 7 x 0,75 mm ²	940602
<ul style="list-style-type: none"> • Para a versão DALI com kit de emergência e telecomando é necessário encomendar 2 cabos de alimentação 5 x 0,75 mm². 	
Caixa de alimentação quadrada	
Saliente T25  45 100	978610
Saliente T29 (DALI+K3)  45 100	978611
Encastrar T7  Ø70 35 90	971400
Encastrar T59 (DALI+K3)  45 90	971410
Caixa de alimentação circular	
Saliente T24  45 Ø95	978600
Saliente T26 (DALI+K3)  45 Ø95	978601
Encastrar T5  Ø70 33 Ø90	971300
Encastrar T27 (DALI+K3)  45 Ø90	978700
Versão Low Output	
<ul style="list-style-type: none"> • Sob consulta. 	



*Substitua os símbolos para completar o código

Cor

<input type="checkbox"/> Branco	W
<input checked="" type="checkbox"/> Preto	B



Detalhes do produto



Perfil exterior



Perfil interior simétrico



Perfil interior assimétrico



Topos sem parafusos visíveis



Uniformidade de luz



Suspensão



Difusor clip-in



Aplicação suspensa



Difusor bGLARE



Difusor bLINE



Difusor ASYM



SwitchDIM Tunable White

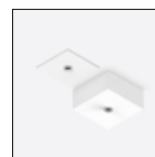

Caixas de alimentação quadradas



Caixas de alimentação circulares



REBA 65 D/I Line



Características do produto

Corpo

Perfil de alumínio extrudido

Acabamento

Revestido a epóxi-poliéster

Sistema ótico

bGLARE - Difusor microprismático

bLINE - Difusor opalino

ASYM - Difusor assimétrico

Fonte de luz

LED, RG1, CRI>80, MacAdam Step ≤ 3

Vida útil LED

80.000h @ L90, B10, Ta 25°C

Fonte de alimentação

Driver LED 220-240V-50/60Hz incluído



230V/50Hz

IP 40

ASYM
850°C

bGLARE
850°C

bLINE
960°C

01. Seleccionar perfil exterior



PERFIL EXTERIOR

Início / Fim (SRT/END)

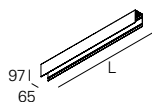

Lmm	CÓDIGO*
1127	90512L0040▲0083
1407	90512L0050▲0083
1687	90512L0060▲0083
2249	90512L0080▲0083
2529	90512L0090▲0083
2809	90512L0100▲0083

Intermédio (MID)

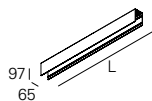

Lmm	CÓDIGO*
1122	90512L0040▲0000
1402	90512L0050▲0000
1682	90512L0060▲0000
2244	90512L0080▲0000
2524	90512L0090▲0000
2804	90512L0100▲0000

Canto horizontal (HRZ) - Esquina horizontal (EDGE)

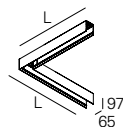

Lmm	CÓDIGO*
608	90512H0040▲0000

*Substitua os símbolos para completar o código

Cor	▲
□ Branco	W
■ Cinzento	G
■ Preto	B

PERFIL EXTERIOR

- Difusor da parte indireta incluído no produto.
- Para completar o produto é necessário encomendar o perfil interior em separado.
- Para completar a linha é necessário encomendar start kit, cablagem de linha contínua e kit de união em separado.
- Para completar o produto é necessário encomendar o perfil interior, suspensão, cabo e caixa de alimentação em separado.
- Dimensões não incluem start kit. Adicione 6 mm ao comprimento para completar a linha.
- O comprimento máximo da linha com um único ponto de alimentação é 15000 mm.

02. Seleccionar perfil interior e difusor



PERFIL INTERIOR | SIMÉTRICO

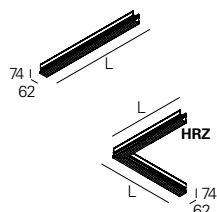

bGLARE - Difusor microprismático (60%/40%)

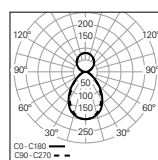

W	lm output	lm/W	Lmm	CÓDIGO*	
52	5250	101	1122	90532L004♥W0♦00	
65	6749	104	1402	90532L005♥W0♦00	
77	8249	107	1682	90532L006♥W♦♦00	
102	10499	103	2244	90532L008♥W0♦00	
117	11999	103	2524	90532L009♥W0♦00	
130	13499	104	2804	90532L010♥W0♦00	
HRZ	45	4500	100	604	90532H004♥W0♦00

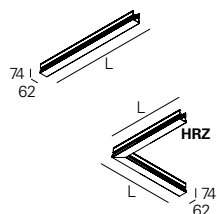

bLINE - Difusor opalino (60%/40%)

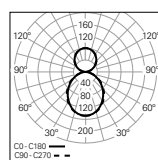

W	lm output	lm/W	Lmm	CÓDIGO*	
52	5340	103	1122	90531L004♥W0♦00	
65	6866	106	1402	90531L005♥W0♦00	
77	8392	109	1682	90531L006♥W♦♦00	
102	10680	105	2244	90531L008♥W0♦00	
117	12206	104	2524	90531L009♥W0♦00	
130	13732	106	2804	90531L010♥W0♦00	
HRZ	45	4577	102	604	90531H004♥W0♦00

*Substitua os símbolos para completar o código

Fonte de alimentação

Fonte de alimentação	Simbol
HF	E
DALI	H
HF+CD ¹	Q
SWD+CD ²	Y

Emergência

Emergência	Simbol
No EM	0
EM 3h (K3) ³	3

Temp. de Cor

Temp. de Cor	Simbol
3000K	3
4000K	0
Tunable White ⁴	T

PERFIL INTERIOR | ASSIMÉTRICO

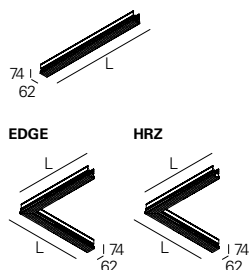

ASYM - Difusor (60%/40%)

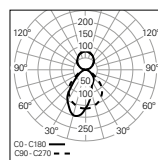

W	lm output	lm/W	Lmm	CÓDIGO*	
51	4888	96	1122	90534L004♥W0♦00	
66	6284	95	1402	90534L005♥W0♦00	
79	7680	97	1682	90534L006♥W♦♦00	
100	9775	98	2244	90534L008♥W0♦00	
117	11172	95	2524	90534L009♥W0♦00	
133	12568	94	2804	90534L010♥W0♦00	
EDGE	44	4189	95	604	90534E004♥W0♦00
HRZ	44	4189	95	604	90534H004♥W0♦00



¹ HF + circuito duplo.

² SwitchDIM + circuito duplo.

³ Preparado para telecomando.

⁴ Apenas disponível nas versões DALI e SWD+CD sem kit de emergência (No EM).

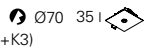
03. Selecionar opções

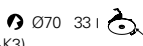
OPÇÕES	Código*
SwitchDIM Tunable White	926600
• Para L ≤ 1682 mm permite controlar no máximo 10 luminárias, L ≥ 1964 mm permite controlar no máximo 5 luminárias por cada SwitchDIM Tunable White.	
Start kit - topo início/fim	923700▲
• Dois topos incluídos.	
Cablagem linha contínua	
• Standard	
3 x 1,5 mm ²	945650
4 x 1,5 mm ²	948400
5 x 1,5 mm ²	945750
• 2 x 1,5 mm²	
HF+K3 (x1) - L562 - L1682 mm	948000
HF+K3 (x2) - L1964 - L2804 mm	948001
• 2 x 1,5 mm² + Junção 5P	
DALI+K3 (x1) - L562 - L1682 mm	948200
DALI+K3 (x2) - L1964 - L2804 mm	948201
• 2 x 1,5 mm² + 2 x 0,75 mm² + Junção 5P	
K3+TEL (x1) - L562 - L1682 mm	948100
K3+TEL (x2) - L1964 - L2804 mm	948101
Kit de união	932210
• União galvanizada, parafusos incluídos.	
Suspensão	
S5 L1500 mm (x1)	910408
S5 L1500 mm (x2)	910409
S5 L3000 mm (x1)	910419
S5 L3000 mm (x2)	910412
S5 L6000 mm (x1)	910420
S5 L6000 mm (x2)	910421
Cabo de alimentação transparente	
3 x 1,5 mm ²	94030▲
5 x 1,5 mm ²	94000▲
7 x 1,5 mm ²	94010▲
• Para a versão DALI com kit de emergência e telecomando é necessário encomendar 2 cabos de alimentação 5 x 1,5 mm ² .	
Caixa de alimentação quadrada ⁵	
Saliente T25	45  100 978610▲
Saliente T29 (DALI+K3)	978611▲
Encastrar T7	 Ø70 35 90 971400▲
Encastrar T59 (DALI+K3)	971410▲
Caixa de alimentação circular ⁵	
Saliente T24	45  Ø95 978600▲
Saliente T26 (DALI+K3)	978601▲
Encastrar T5	 Ø70 33 Ø90 971300▲
Encastrar T27 (DALI+K3)	978700▲
Módulo cego	
L1500 mm	993040▲
L3000 mm	993041▲
• Inclui perfil interior e tampa de encaixe em alumínio.	
Versão Low Output	
• Sob consulta.	
Projetos à medida	
• Sob consulta.	



*Substitua os símbolos para completar o código

Comprimento	▲
L1500 mm	0
L3000 mm	1
L6000 mm	2

Cor ⁵	▲
<input type="checkbox"/> Branco	W
<input type="checkbox"/> Cinzento	G
<input type="checkbox"/> Preto	B



Detalhes do produto



Perfil exterior

Perfil interior simétrico

Perfil interior assimétrico



Topos sem parafusos visíveis

União sem saída de luz

Uniformidade de luz



Suspensão

Difusor clip-in

Canto horizontal



Aplicação suspensa

Difusor bGLARE

Difusor bLINE



Difusor ASYM

SwitchDIM Tunable White

Start kit



Caixas de alimentação quadradas

Caixas de alimentação circulares

⁵ As caixas de alimentação apenas estão disponíveis na cor branca ou preta.





ILUMINAÇÃO TÉCNICA





CORA



CORA /E
620



CORA
624



CORA /C
628



Tipos de aplicação



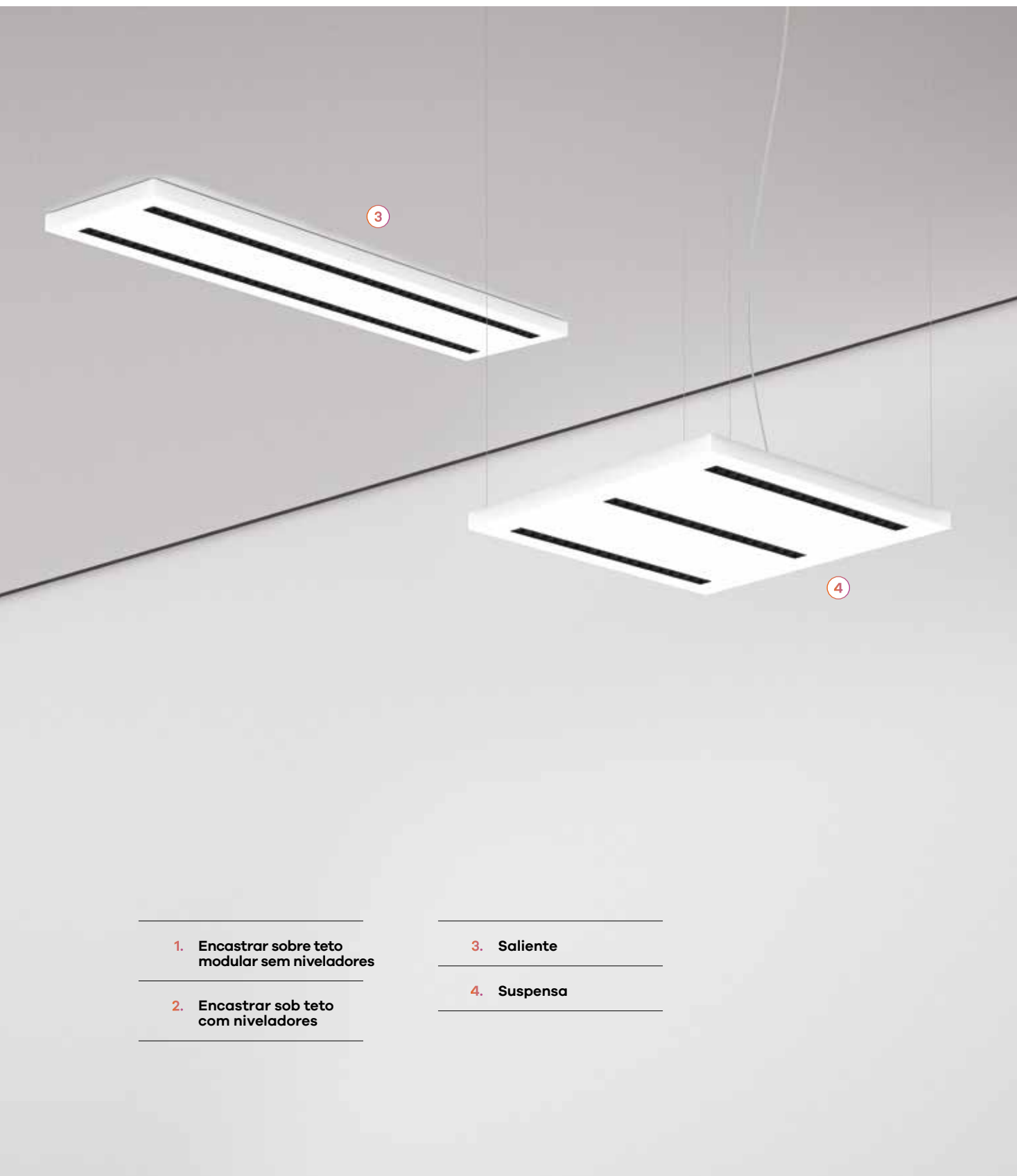

1. Encastrar sobre teto modular sem niveladores

2. Encastrar sob teto com niveladores

3. Saliente

4. Suspensa

CORA /E



Características do produto

Corpo

Chapa de aço

Acabamento

Revestido a epóxi-poliéster

Sistema ótico

bOPTICS - Refletor simétrico

Fonte de luz

LED, RG1, CRI>80, MacAdam Step ≤3

Vida útil LED

80.000h @ L90, B10, Ta 25°C

Fonte de alimentação

Driver LED 220-240V-50/60Hz incluído

Espessura do teto

Versão de encastrar sobre tetos modulares de perfil T visível 15/24 mm sem niveladores

Versão de encastrar sob teto 10, 13, 15 e 18 mm com niveladores



230V/50Hz



IP 20

650°C



01. Selecionar versão



CORA / E 2

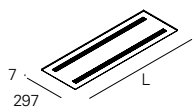

bOPTICS - Refletor simétrico 48°

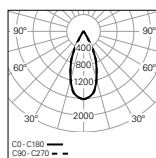

UGR	W	lm output	lm/W	Lmm	ƒ	CÓDIGO*
≤10	18	2272	126	597	572x272	90729L260▼▲◆♦00
≤10	30	3779	126	897	872x272	90729L290▼▲◆♦00
≤10	39	5286	136	1197	1172x272	90729L212▼▲◆♦00
≤10	50	6816	136	1497	1472x272	90729L215▼▲◆♦00

*Substitua os símbolos para completar o código

Fonte de alimentação ▼
 HF E
 DALI H

Cor ▲
 Branco W
 Preto B

Emergência ●
 No EM 0
 EM 3h (K3) ¹ 3

Temp. de Cor ◆
 3000K 3
 4000K 0

CORA / E 3

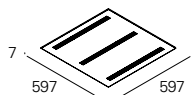

bOPTICS - Refletor simétrico 48°

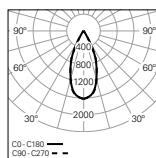

UGR	W	lm output	lm/W	ƒ	CÓDIGO*
≤10	26	3408	131	572x572	90729Q360▼▲◆♦00

CORA / E 4

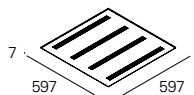

bOPTICS - Refletor simétrico 48°

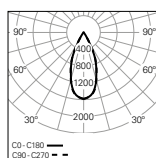

UGR	W	lm output	lm/W	ƒ	CÓDIGO*
≤10	34	4544	134	572x572	90729Q460▼▲◆♦00

CORA 2 | CORA 3 | CORA 4

• Para versão de encastrar sob teto de pladur é necessário encomendar kit encastrar (x4) em separado.

¹ Preparado para telecomando.

02. Selecionar opções

OPÇÕES	Código
Kit encastrar (x4)	927700
Cabo de segurança em aço L1500 mm	955000
Versão Low Output <ul style="list-style-type: none">• Sob consulta.	
Projetos à medida <ul style="list-style-type: none">• Sob consulta.	



Detalhes do produto



Aplicação sobre tetos modulares de perfil T visível



Aplicação de encastrar sob teto com niveladores



Difusor bOPTICS

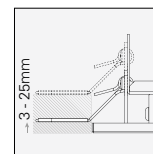

Aplicação de encastrar sob teto com niveladores



Aplicação de encastrar sob teto com niveladores

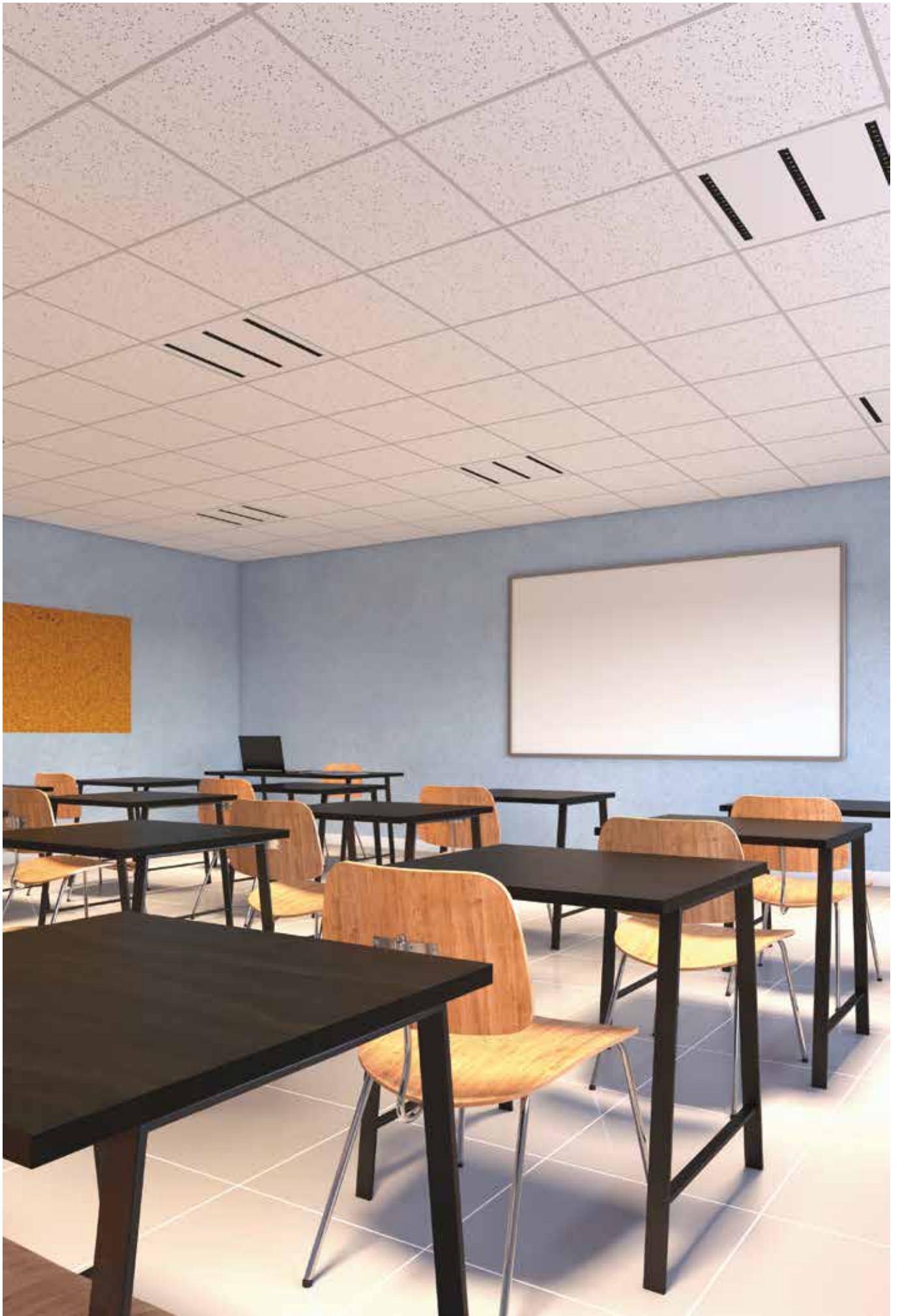

CORA



Características do produto

Corpo

Chapa de aço



Acabamento

Revestido a epóxi-poliéster

230V/50Hz

Sistema ótico

bOPTICS - Refletor simétrico

Fonte de luz

LED, RG1, CRI>80, MacAdam Step ≤ 3



Vida útil LED

80.000h @ L90, B10, Ta 25°C

650°C

Fonte de alimentação

Driver LED 220-240V-50/60Hz incluído

01. Seleccionar versão



CORA 2

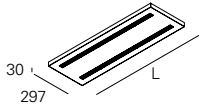

bOPTICS - Refletor simétrico 48°

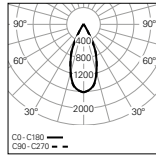

UGR	W	lm output	lm/W	Lmm	CÓDIGO*
≤10	18	2272	126	597	90727L260♥♣♦♦00
≤10	30	3779	126	897	90727L290♥♣♦♦00
≤10	39	5286	136	1197	90727L212♥♣♦♦00
≤10	50	6816	136	1497	90727L215♥♣♦♦00

*Substitua os símbolos para completar o código

Fonte de alimentação ▼

HF	E
DALI	H

Cor ▲

□ Branco	W
■ Preto	B

Emergência ●

No EM	0
EM 3h (K3) ¹	3

Temp. de Cor ◆

3000K	3
4000K	0

CORA 3

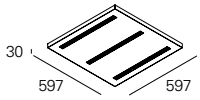

bOPTICS - Refletor simétrico 48°

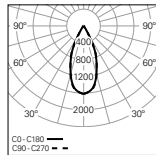

UGR	W	lm output	lm/W	CÓDIGO*
≤10	26	3408	131	90727Q360♥♣♦♦00

CORA 4

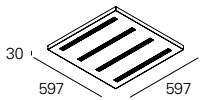

bOPTICS - Refletor simétrico 48°

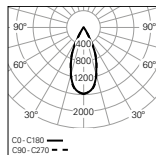





UGR	W	lm output	lm/W	CÓDIGO*
≤10	34	4544	134	90727Q460♥♣♦♦00

CORA 2 | CORA 3 | CORA 4

• Para completar o produto é necessário encomendar suspensão, cabo e caixa de alimentação em separado.

¹ Preparado para telecomando.

02. Selecionar opções

OPÇÕES	Código*
Suspensão	
S11 L1500 mm (x4)	9129041
S11 L3000 mm (x4)	9129042
S11 L6000 mm (x4)	9129043
Cabo de alimentação transparente	
L1500 mm - 3 x 0,75 mm ²	940400
L1500 mm - 5 x 0,75 mm ²	940500
L1500 mm - 7 x 0,75 mm ²	940600
L3000 mm - 3 x 0,75 mm ²	940401
L3000 mm - 5 x 0,75 mm ²	940501
L3000 mm - 7 x 0,75 mm ²	940601
L6000 mm - 3 x 0,75 mm ²	940402
L6000 mm - 5 x 0,75 mm ²	940507
L6000 mm - 7 x 0,75 mm ²	940602
<ul style="list-style-type: none"> • Para a versão DALI com kit de emergência e telecomando é necessário encomendar 2 cabos de alimentação 5 x 0,75 mm². 	
Caixa de alimentação	
Saliente T25  45 l  100	978610▲
Saliente T29 (DALI+K3)	978611▲
Encastrar T7  Ø70 35 l  90	971400▲
Encastrar T59 (DALI+K3)	971410▲
Versão Low Output	
<ul style="list-style-type: none"> • Sob consulta. 	



*Substitua os símbolos para completar o código

Cor

<input type="checkbox"/> Branco	W
<input checked="" type="checkbox"/> Preto	B



Detalhes do produto



Aplicação suspensa



Difusor bOPTICS

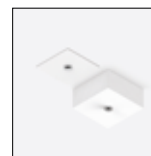

Caixas de alimentação

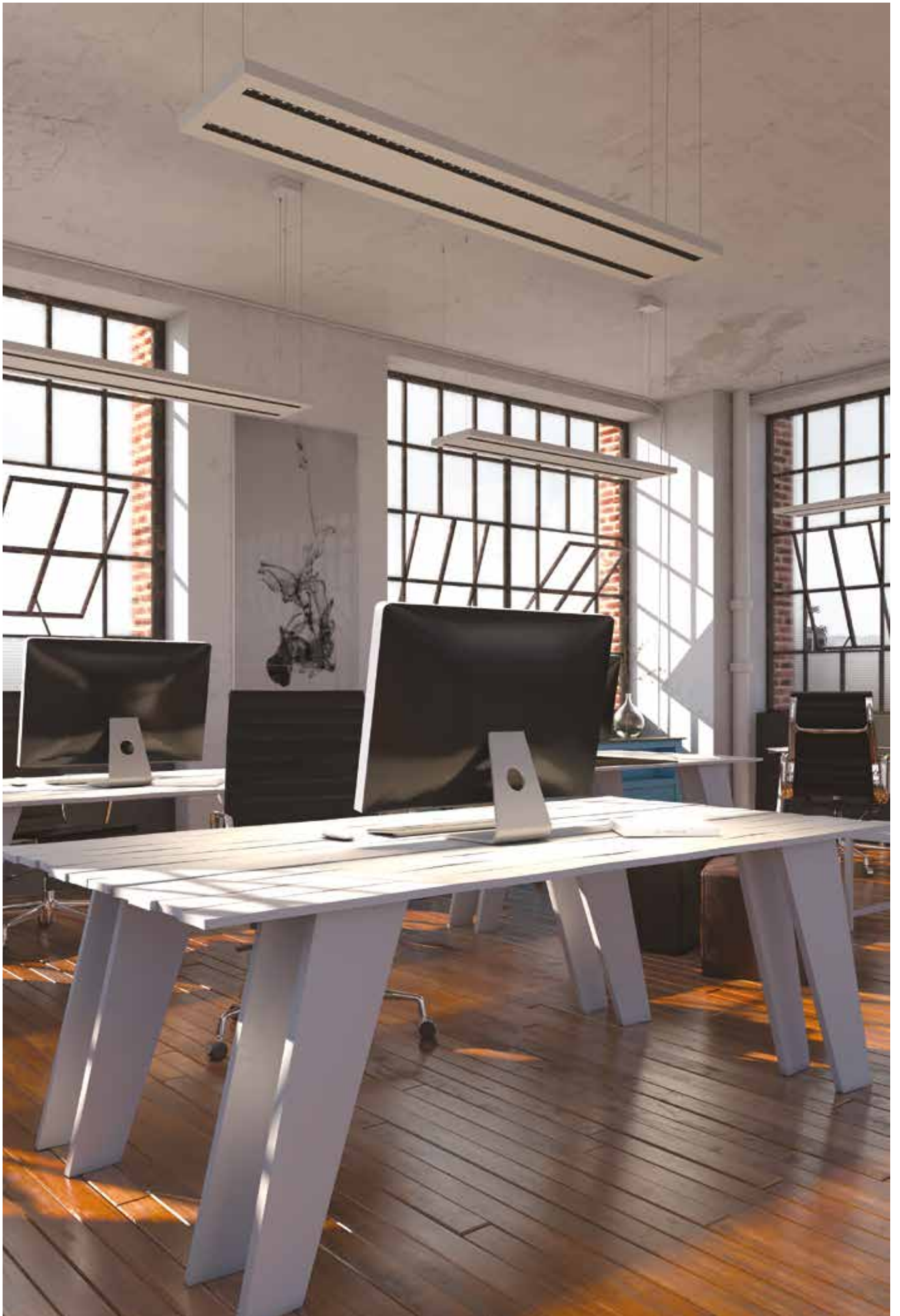

CORA /C



Características do produto

Corpo

Chapa de aço



Acabamento

Revestido a epóxi-poliéster

230V/50Hz

Sistema ótico

bOPTICS - Refletor simétrico



IP 20

Fonte de luz

LED, RG1, CRI>80, MacAdam Step ≤ 3

Vida útil LED

80.000h @ L90, B10, Ta 25°C

650°C

Fonte de alimentação

Driver LED 220-240V-50/60Hz incluído

01. Selecionar versão



CORA / C 2

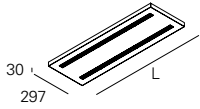

bOPTICS - Refletor simétrico 48°

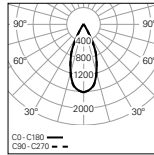

UGR	W	lm output	lm/W	Lmm	CÓDIGO*
≤10	18	2272	126	597	90728L260▼▲◆♦00
≤10	30	3779	126	897	90728L290▼▲◆♦00
≤10	39	5286	136	1197	90728L212▼▲◆♦00
≤10	50	6816	136	1497	90728L215▼▲◆♦00

*Substitua os símbolos para completar o código

Fonte de alimentação	▼
HF	E
DALI	H

Cor	▲
□ Branco	W
■ Preto	B

Emergência	●
No EM	0
EM 3h (K3) ¹	3

CORA / C 3

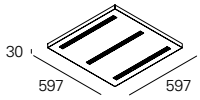

bOPTICS - Refletor simétrico 48°

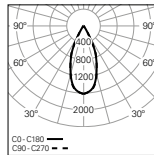

UGR	W	lm output	lm/W	CÓDIGO*
≤10	26	3408	131	90728Q360▼▲◆♦00

Temp. de Cor	◆
3000K	3
4000K	0

CORA / C 4

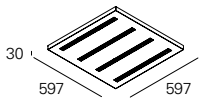

bOPTICS - Refletor simétrico 48°

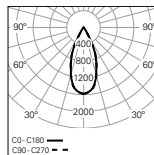

UGR	W	lm output	lm/W	CÓDIGO*
≤10	34	4544	134	90728Q460▼▲◆♦00

¹ Preparado para telecomando.

02. Selecionar opções

OPÇÕES	Código
--------	--------

Versão Low Output

- Sob consulta.



Detalhes do produto



Aplicação saliente



Difusor bOPTICS

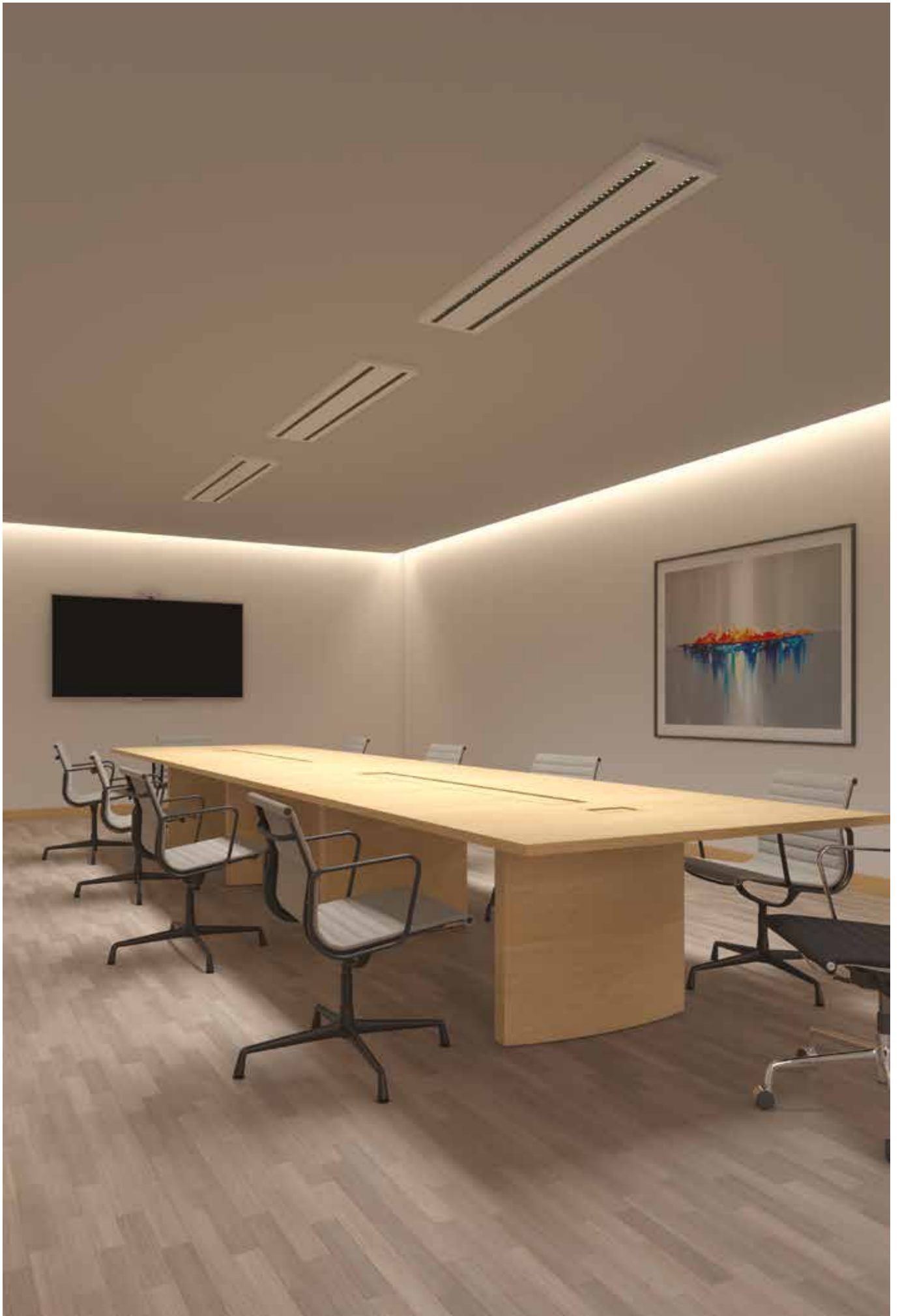



Iluminação
técnica

CLOUD



CLOUD
634



CLOUD

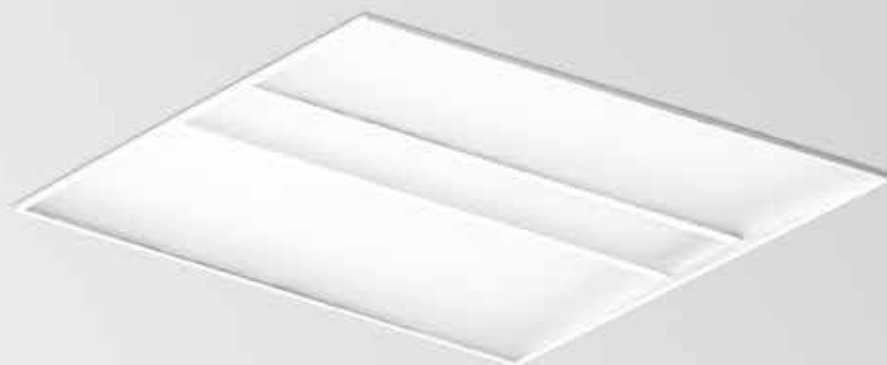

Características do produto

Corpo

Chapa de aço



Acabamento

Revestido a epóxi-poliéster em branco mate

230V/50Hz

Sistema de fixação

Versão de encastrar sob teto com niveladores



Sistema ótico

DAM - Difusor microprismático

Fonte de luz

LED, RG1, CRI>80, MacAdam Step ≤3



Vida útil LED

80.000h @ L90, B10, Ta 25°C

Fonte de alimentação

Driver LED 220-240V-50/60Hz incluído

Espessura do teto

Para tetos entre 1-25 mm

01. Seleccionar versão



CLOUD

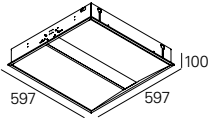

DAM - Difusor microprismático

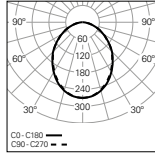

UGR	W	lm output	lm/W	□	CÓDIGO*
≤19	41	4370	107	582x582	90840L060▼W●◆♣
≤22	47	5376	114	582x582	90839L060▼W●◆♣

*Substitua os símbolos para completar o código

Fonte de alimentação	▼
HF	E
DALI	H

Emergência	●
No EM	0
EM 3h (K3) ¹	3

Temp. de Cor	◆
3000K	3
4000K	0

Conetor	♣
Sem conetor	00
W3M ²	W3
W5MD ³	W5

02. Seleccionar opções



Detalhes do produto

OPÇÕES	Código
Cabo de segurança em aço L1500 mm	955000
Fluxo de ar • Sob consulta.	
Projetos à medida • Sob consulta.	



Conetor DALI



Sistema de fluxo de ar

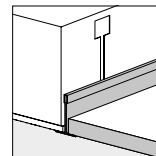

Aplicação sobre tetos modulares de perfil T visível

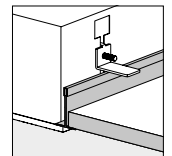

Aplicação sob tetos modulares de perfil T visível com niveladores

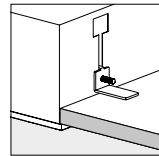

Aplicação de encastrar sob teto com niveladores

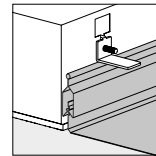

Aplicação sob tetos modulares SAS 150 com niveladores

¹ Preparado para telecommando.

² Conetor macho Wieland de 3 pólos GST1813.

³ Conetor macho Wieland de 5 pólos GST1815 DIM.



Iluminação
técnica

TEI



TEI
638





Características do produto

Corpo

Chapa de aço



Acabamento

Revestido a epóxi-poliéster em branco mate

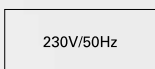

Sistema de fixação

Versão de encastrar sob teto com niveladores



Sistema ótico

DCS - Difusor microperfurado

Fonte de luz

LED, RG1, CRI>80, MacAdam Step ≤ 3



Vida útil LED

80.000h @ L90, B10, Ta 25°C

Fonte de alimentação

Driver LED 220-240V-50/60Hz incluído

Espessura do teto

Para tetos entre 1-25 mm

01. Seleccionar versão

TEI

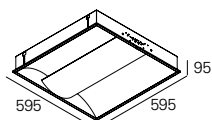

DCS - Difusor microperfurado

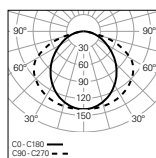

UGR	W	lm output	lm/W	□	CÓDIGO*
≤19	29	2223	77	578x578	90853L060▼W●●♣
≤22	43	3334	78	578x578	90852L060▼W●●♣



*Substitua os símbolos para completar o código

Fonte de alimentação	▼
HF	E
DALI	H

Emergência	●
No EM	0
EM 3h (K3) ¹	3

Temp. de Cor	◆
3000K	3
4000K	0

Conetor	♣
Sem conetor	00
W3M ²	W3
W5MD ³	W5

02. Seleccionar opções

OPÇÕES	Código
--------	--------

Cabo de segurança em aço L1500 mm	955000
---	--------

Projetos à medida

- Sob consulta.

¹ Preparado para telecomando.

² Conetor macho Wieland de 3 pólos GST18I3.

³ Conetor macho Wieland de 5 pólos GST18I5 DIM.



Iluminação
técnica

bLED



bLED
642



bLED

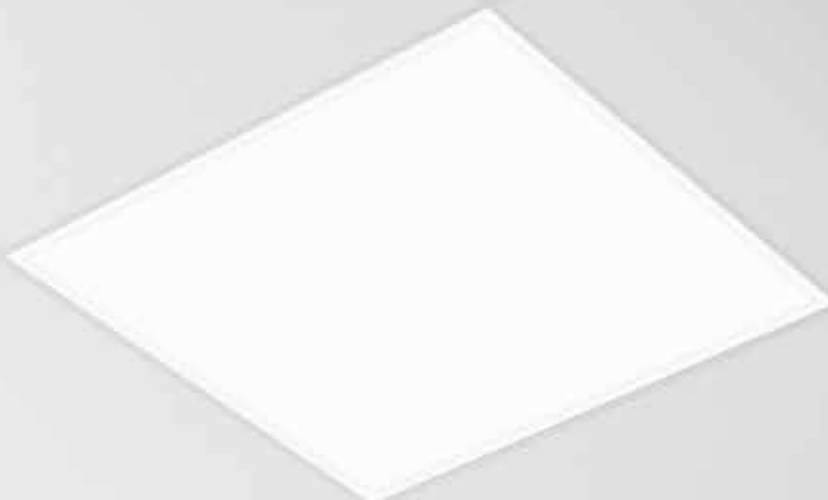

Características do produto

Corpo

Chapa de aço



Acabamento

Revestido a epóxi-poliéster em branco mate

230V/50Hz

Sistema de fixação

Versão de encastrar sobre tetos
modulares de perfil T visível 15/24 mm
sem niveladores



Sistema ótico

DAM - Difusor microprismático
LIGHT+ - Difusor opalino



Fonte de luz

LED, RG1, CRI>80, MacAdam Step ≤3

Vida útil LED

80.000h @ L90, B10, Ta 25°C

Fonte de alimentação

Driver LED 220-240V-50/60Hz incluído

01. Selecionar versão

bLED

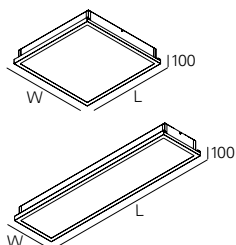

DAM - Difusor microprismático

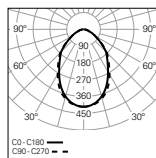

UGR	W	lm output	lm/W	LxWmm	CÓDIGO*
≤19	44	5683	129	595x595	90843L060▼W◆◆00
≤19	44	5683	129	1195x295	90843L120▼W◆◆00

LIGHT+ - Difusor opalino

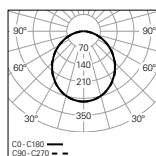

UGR	W	lm output	lm/W	LxWmm	CÓDIGO*
≤22	44	6144	140	595x595	90841L060▼W◆◆00
≤22	44	6144	140	1195x295	90841L120▼W◆◆00



*Substitua os símbolos para completar o código

Fonte de alimentação ▼
 HF E
 DALI H

Emergência ●
 No EM 0
 EM 3h (K3) ¹ 3

Temp. de Cor ◆
 3000K 3
 4000K 0

02. Selecionar opções

OPÇÕES Código

Cabo de segurança em aço
 L1500 mm 955000

Versão IP20/65

- Sob consulta.

CRI>90

- Sob consulta.

Versão Low Output

- Sob consulta.

Projetos à medida

- Sob consulta.



Detalhes do produto

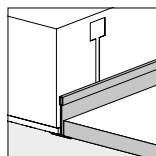

Aplicação sobre tetos modulares de perfil T visível

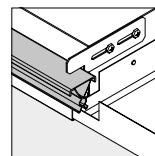

Aplicação sobre tetos modulares SAS 120 (sob consulta)

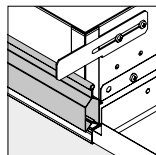

Aplicação sobre tetos modulares SAS 150/330 (sob consulta)

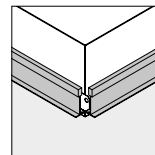

Aplicação sobre tetos modulares Microlook 8 (sob consulta)

¹ Preparado para telecomando.



Iluminação
técnica

LNE



LNE
646



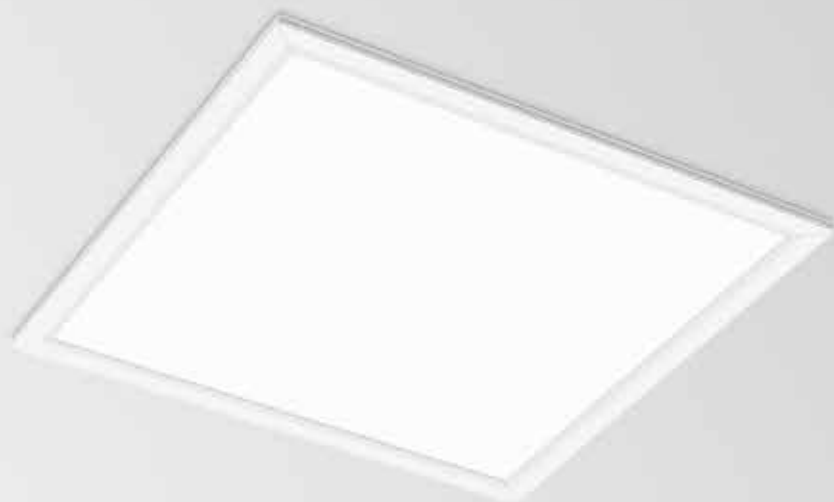

Características do produto

Corpo

Chapa de aço



Aro

Alumínio

230V/50Hz

Acabamento

Revestido a epóxi-poliéster em branco mate

Sistema de fixação

Versão de encastrar sob teto com niveladores



Sistema ótico

DAM - Difusor microprismático
LIGHT+ - Difusor opalino



Fonte de luz

LED, RG1, CRI>80, MacAdam Step ≤3

Vida útil LED

80.000h @ L80, B10, Ta 25°C

Fonte de alimentação

Driver LED 220-240V-50/60Hz incluído

Espessura do teto

Para tetos entre 1-25 mm

01. Selecionar versão

LNE

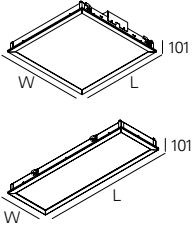

DAM - Difusor microprismático

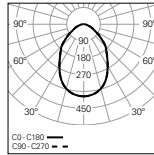

UGR	W	lm output	lm/W	LxWmm	□	CÓDIGO*
≤19	26	3169	122	897x297	882x282	90827L093♥W●●♣
≤19	34	4225	124	1197x297	1182x282	90827L123♥W●●♣
≤19	42	5282	126	1497x297	1482x282	90827L153♥W●●♣
≤19	34	4225	124	597x597	582x582	90827L066♥W●●♣

LIGHT+ - Difusor opalino

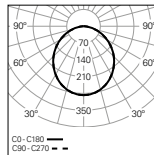

UGR	W	lm output	lm/W	LxWmm	□	CÓDIGO*
≤22	26	3441	132	897x297	882x282	90828L093♥W●●♣
≤22	34	4587	135	1197x297	1182x282	90828L123♥W●●♣
≤22	42	5734	137	1497x297	1482x282	90828L153♥W●●♣
≤22	34	4587	135	597x597	582x582	90828L066♥W●●♣



*Substitua os símbolos para completar o código

Fonte de alimentação	▼
HF	E
DALI	H

Emergência	●
No EM	0
EM 3h (K3) ¹	3

Temp. de Cor	◆
3000K	3
4000K	0

Conetor	♣
Sem conetor	00
W3M ²	W3
W5MD ³	W5

02. Selecionar opções

OPÇÕES Código

CRI>90

- Sob consulta.

Cabo de segurança em aço

L1500 mm 955000



Detalhes do produto



Aro com sistema click

¹ Preparado para telecomando.

² Conetor macho Wieland de 3 pólos GST18I3.

³ Conetor macho Wieland de 5 pólos GST18I5 DIM.



Iluminação
técnica

LNS



LNS
650



LNS



Características do produto

Corpo

Chapa de aço

Acabamento

Revestido a epóxi-poliéster em branco mate

Sistema ótico

DAM - Difusor microprismático
LIGHT+ - Difusor opalino

Fonte de luz

LED, RG1, CRI>80, MacAdam Step ≤ 3

Vida útil LED

80.000h @ L80, B10, Ta 25°C

Fonte de alimentação

Driver LED 220-240V-50/60Hz incluído



230V/50Hz



IP 40

650°C

01. Selecionar versão

LNS

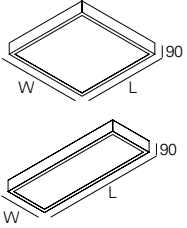

DAM - Difusor microprismático

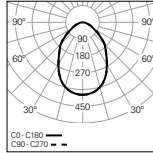

UGR	W	lm output	lm/W	LxWmm	CÓDIGO*
≤19	26	3169	122	873x320	90829L063▼W◆◆00
≤19	34	4225	124	1149x320	90829L123▼W◆◆00
≤19	42	5282	126	1425x320	90829L153▼W◆◆00
≤19	34	4225	124	597x597	90829L066▼W◆◆00

LIGHT+ - Difusor opalino

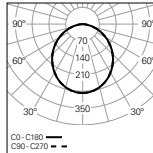

UGR	W	lm output	lm/W	LxWmm	CÓDIGO*
≤22	26	3441	132	873x320	90830L063▼W◆◆00
≤22	34	4587	135	1149x320	90830L123▼W◆◆00
≤22	42	5734	137	1425x320	90830L153▼W◆◆00
≤22	34	4587	135	597x597	90830L066▼W◆◆00



*Substitua os símbolos para completar o código

Fonte de alimentação	
HF	E
DALI	H

Emergência	
No EM	0
EM 3h (K3) ¹	3

Temp. de Cor	
3000K	3
4000K	0

02. Selecionar opções

OPÇÕES

CRI>90

- Sob consulta.



Detalhes do produto



Aro com sistema click

¹ Preparado para telecomando.

AMBIENTES ASSÉTICOS





**Ambientes
asséticos**

HOSPITAL AND CLEAN ROOMS



AVT
656



THE
658



THS
660



LNE IP
662



LNS IP
664



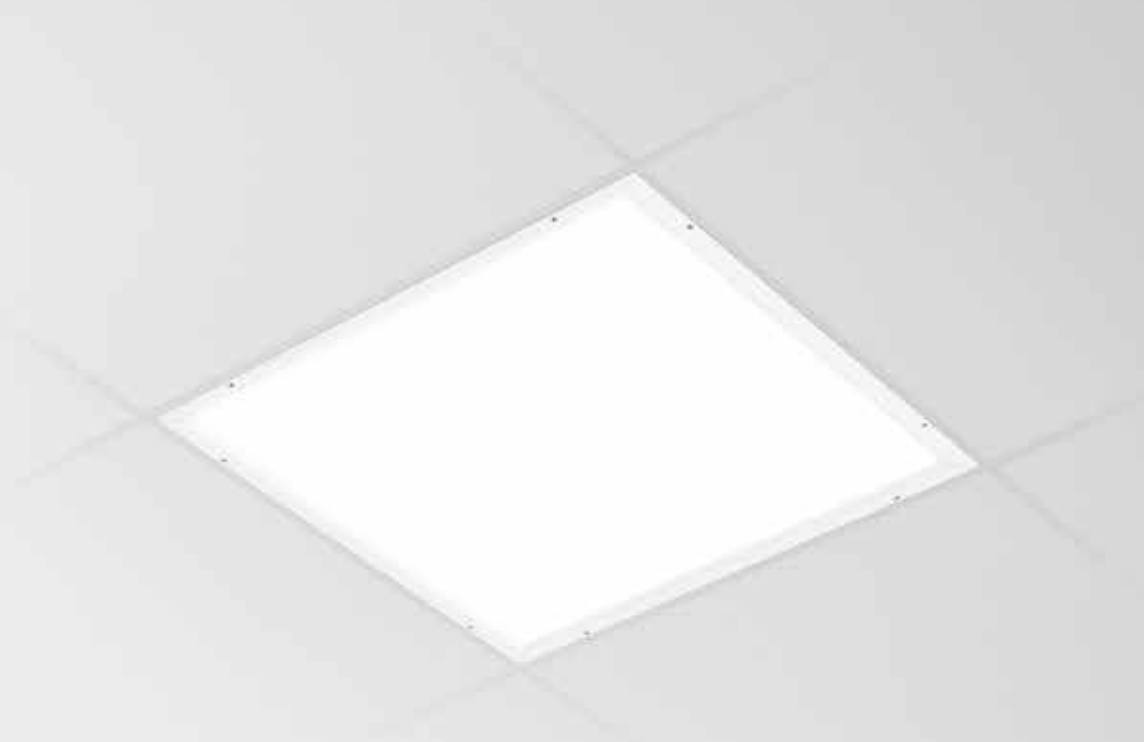

Características do produto

Corpo

Chapa de aço



Aro

Alumínio

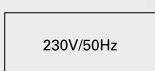

Acabamento

Revestido a epóxi-poliéster em branco mate

Sistema de fixação

Versão de encastrar sobre tetos modulares
de perfil T visível sem niveladores



Cablagem

Pré-cablagem com cabo H05VV-F
de 1000 mm



Sistema ótico

DAM - Difusor microprismático
LIGHT+ - Difusor opalino

Fonte de luz

LED, RG1, CRI>80, MacAdam Step ≤3

Vida útil LED

80.000h @ L80, B10, Ta 25°C

Fonte de alimentação

Driver LED 220-240V-50/60Hz incluído

01. Selecionar versão



AVT

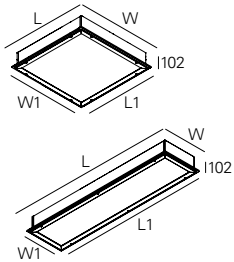

DAM - Difusor microprismático

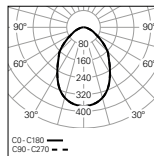

UGR	W	Im output	Im/W	LxWmm	L1xW1mm	CÓDIGO*
≤19	34	4104	121	1197x297	1175x275	90797L123▼VV●000
≤19	42	5131	122	1497x297	1475x275	90797L153▼VV●000
≤22	74	8656	117	1497x297	1475x275	90799L153▼VV●000
≤19	34	4104	121	597x597	575x575	90797L066▼VV●000
≤19	59	6925	117	597x597	575x575	90799L066▼VV●000

LIGHT+ - Difusor opalino

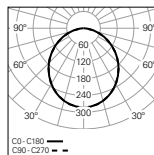

UGR	W	Im output	Im/W	LxWmm	L1xW1mm	CÓDIGO*
≤22	34	4527	133	1197x297	1175x275	90798L123▼VV●000
≤22	42	5659	135	1497x297	1475x275	90798L153▼VV●000
≤25	74	9548	129	1497x297	1475x275	90800L153▼VV●000
≤22	34	4527	133	597x597	575x575	90798L066▼VV●000
≤22	59	7638	129	597x597	575x575	90800L066▼VV●000

*Substitua os símbolos para completar o código

Fonte de alimentação ▼
 HF E
 DALI H

Emergência ●
 No EM 0
 EM 3h (K3) ¹ 3

02. Selecionar opções



Detalhes do produto

OPÇÕES	Código
Conetor	
Conetor macho Wieland de 3 pólos GST18i3	965301
Conetor macho Wieland de 5 pólos GST18i5	
DIM	965403
Cabo de segurança em aço	
L1500 mm	955000
CRI>90	
• Sob consulta.	
Projetos à medida	
• Sob consulta.	



Aplicação sobre tetos modulares sem niveladores

¹ Preparado para telecomando.

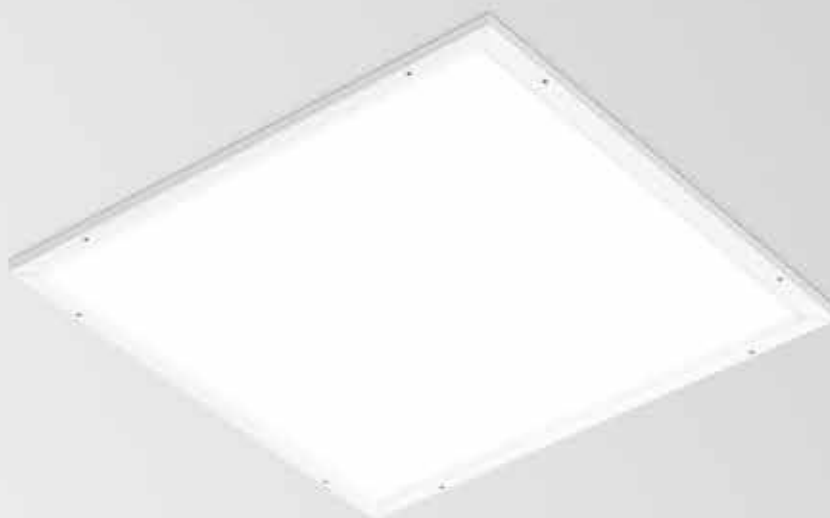

Características do produto

Corpo

Chapa de aço

Aro

Alumínio

Acabamento

Revestido a epóxi-poliéster em branco mate

Sistema de fixação

Versão de encastrar sob teto com niveladores

Cablagem

Pré-cablagem com cabo H05VV-F
de 1000 mm

Sistema ótico

DAM - Difusor microprismático
LIGHT+ - Difusor opalino

Fonte de luz

LED, RG1, CRI>80, MacAdam Step ≤ 3

Vida útil LED

80.000h @ L80, B10, Ta 25°C

Fonte de alimentação

Driver LED 220-240V-50/60Hz incluído

Espessura do teto

Para tetos entre 2-60 mm

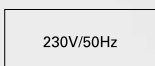

01. Selecionar versão



THE

*Substitua os símbolos para completar o código

Fonte de alimentação ▼
HF E
DALI H

Emergência ●
No EM 0
EM 3h (K3) ¹ 3

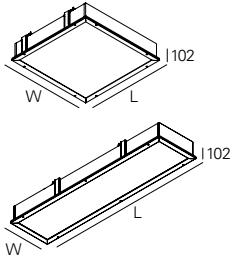

DAM - Difusor microprismático

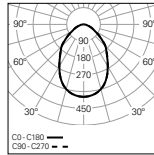

UGR	W	lm output	lm/W	LxWmm	■	CÓDIGO*
≤19	34	4225	124	1197x297	1180x288	90793L123▼W●000
≤19	42	5282	126	1497x297	1480x288	90793L153▼W●000
≤19	74	8911	120	1497x297	1480x288	90795L153▼W●000
≤19	34	4225	124	597x597	580x588	90793L066▼W●000
≤19	59	7129	121	597x597	580x588	90795L066▼W●000

LIGHT+ - Difusor opalino

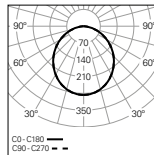

UGR	W	lm output	lm/W	LxWmm	■	CÓDIGO*
≤22	34	4587	135	1197x297	1180x288	90794L123▼W●000
≤22	42	5734	137	1497x297	1480x288	90794L153▼W●000
≤25	74	9675	131	1497x297	1480x288	90796L153▼W●000
≤22	34	4587	135	597x597	580x588	90794L066▼W●000
≤22	59	7740	131	597x597	580x588	90796L066▼W●000

02. Selecionar opções

OPÇÕES Código

Conetor

Conetor macho Wieland de 3 pólos GST18i3 965301
Conetor macho Wieland de 5 pólos GST18i5 DIM 965403

Cabo de segurança em aço

L1500 mm 955000

CRI>90

• Sob consulta.

Projetos à medida

• Sob consulta.



Detalhes do produto



Aplicação de encastrar sob teto com niveladores



Nivelador

¹ Preparado para telecomando.

THS



Características do produto

Corpo

Chapa de aço

Aro

Alumínio

Acabamento

Revestido a epóxi-poliéster em branco mate

Sistema ótico

DAM - Difusor microprismático
LIGHT+ - Difusor opalino

Fonte de luz

LED, RG1, CRI>80, MacAdam Step ≤ 3

Vida útil LED

80.000h @ L80, B10, Ta 25°C

Fonte de alimentação

Driver LED 220-240V-50/60Hz incluído



230V/50Hz



IP 65

650°C

01. Seleccionar versão

THS

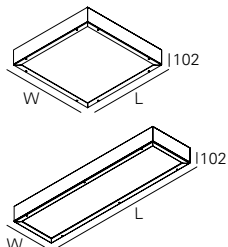

DAM - Difusor microprismático

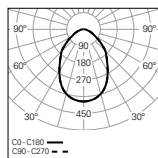

UGR	W	lm output	lm/W	LxWmm	CÓDIGO*
≤19	34	4225	124	1142x297	90801L123▼W●000
≤19	42	5282	126	1417x297	90801L153▼W●000
≤22	74	8911	120	1417x297	90803L153▼W●000
≤19	34	4225	124	597x597	90801L066▼W●000
≤19	59	7129	121	597x597	90803L066▼W●000

LIGHT+ - Difusor opalino

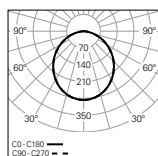

UGR	W	lm output	lm/W	LxWmm	CÓDIGO*
≤22	34	4587	135	1142x297	90802L123▼W●000
≤22	42	5734	137	1417x297	90802L153▼W●000
≤25	74	9675	120	1417x297	90804L153▼W●000
≤22	34	4587	135	597x597	90802L066▼W●000
≤22	59	7740	121	597x597	90804L066▼W●000



*Substitua os símbolos para completar o código

Fonte de alimentação ▼
 HF E
 DALI H

Emergência ●
 No EM 0
 EM 3h (K3) ¹ 3

02. Seleccionar opções

OPÇÕES

CRI>90

- Sob consulta.

LNE IP

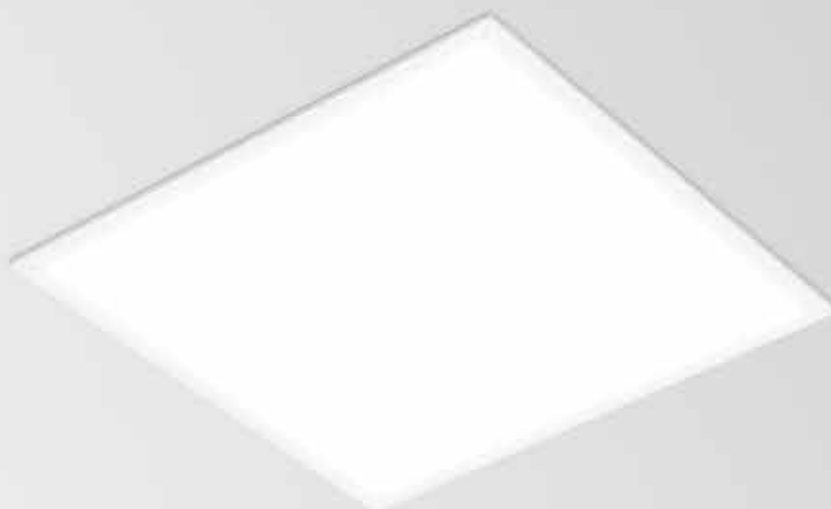

Características do produto

Corpo

Chapa de aço



Aro

Chapa de aço

230V/50Hz

Acabamento

Revestido a epóxi-poliéster em branco mate

Sistema de fixação

Versão de encastrar sob teto com niveladores



IP 20/54

Sistema ótico

DAM - Difusor microprismático
LIGHT+ - Difusor opalino

650°C



Fonte de luz

LED, RG1, CRI>80, MacAdam Step ≤ 3

Vida útil LED

80.000h @ L80, B10, Ta 25°C

Fonte de alimentação

Driver LED 220-240V-50/60Hz incluído

Espessura do teto

Para tetos entre 1-25 mm

01. Selecionar versão

LNE IP

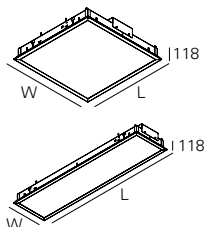

DAM - Difusor microprismático

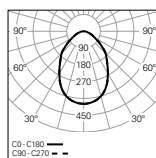

UGR	W	lm output	lm/W	LxWmm	□	CÓDIGO*
≤19	34	4225	124	1197x297	1180x280	90805L123▼W●000
≤19	42	5282	126	1479x297	1480x280	90805L153▼W●000
≤19	34	4225	124	597x597	580x588	90805L066▼W●000

LIGHT+ - Difusor opalino

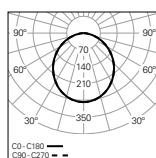

UGR	W	lm output	lm/W	LxWmm	□	CÓDIGO*
≤22	34	4587	135	1197x297	1180x280	90806L123▼W●000
≤22	42	5734	137	1479x297	1480x280	90806L153▼W●000
≤22	34	4587	135	597x597	580x588	90806L066▼W●000



*Substitua os símbolos para completar o código

Fonte de alimentação ▼
HF E
DALI H

Emergência ●
No EM 0
EM 3h (K3) ¹ 3

02. Selecionar opções

OPÇÕES	Código
Conetor	
Conetor macho Wieland de 3 pólos GST18i3	965301
Conetor macho Wieland de 5 pólos GST18i5 DIM	965403
Cabo de segurança em aço	
L1500 mm	955000



Detalhes do produto



Aplicação de encastrar sob teto com niveladores

¹ Preparado para telecomando.

LNS IP



Características do produto

Corpo

Chapa de aço

Aro

Chapa de aço

Acabamento

Revestido a epóxi-poliéster em branco mate

Sistema ótico

DAM - Difusor microprismático
LIGHT+ - Difusor opalino

Fonte de luz

LED, RG1, CRI>80, MacAdam Step ≤3

Vida útil LED

80.000h @ L80, B10, Ta 25°C

Fonte de alimentação

Driver LED 220-240V-50/60Hz incluído



230V/50Hz



IP 54

650°C

01. Selecionar versão

LNS IP

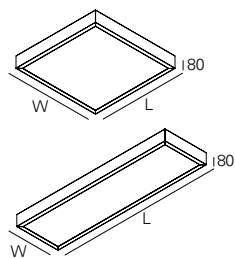

DAM - Difusor microprismático

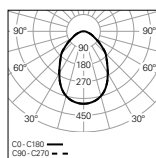

UGR	W	lm output	lm/W	LxWmm	CÓDIGO*
≤19	34	4225	124	1149x320	90809L123▼W●000
≤19	42	5282	126	1425x320	90809L153▼W●000
≤19	34	4225	124	597x597	90809L066▼W●000

LIGHT+ - Difusor opalino

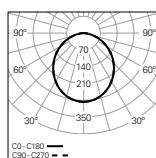

UGR	W	lm output	lm/W	LxWmm	CÓDIGO*
≤22	34	4587	135	1149x320	90810L123▼W●000
≤22	42	5734	137	1425x320	90810L153▼W●000
≤22	34	4587	135	597x597	90810L066▼W●000



*Substitua os símbolos para completar o código

Fonte de alimentação ▼
 HF E
 DALI H

Emergência ●
 No EM 0
 EM 3h (K3) ¹ 3

02. Selecionar opções

OPÇÕES

Código

Conetor

Conetor macho Wieland de 3 pólos GST18i3	965301
Conetor macho Wieland de 5 pólos GST18i5	
DIM	965403

¹ Preparado para telecomando.

Capítulo
05

LUMINÁRIAS TUBULARES





Luminárias
tubulares

TALEA



TALEA
678



TALEA HRZ
678



TALEA Line
682



TALEA Glare /C
686



TALEA Glare
690



Tipos de aplicação

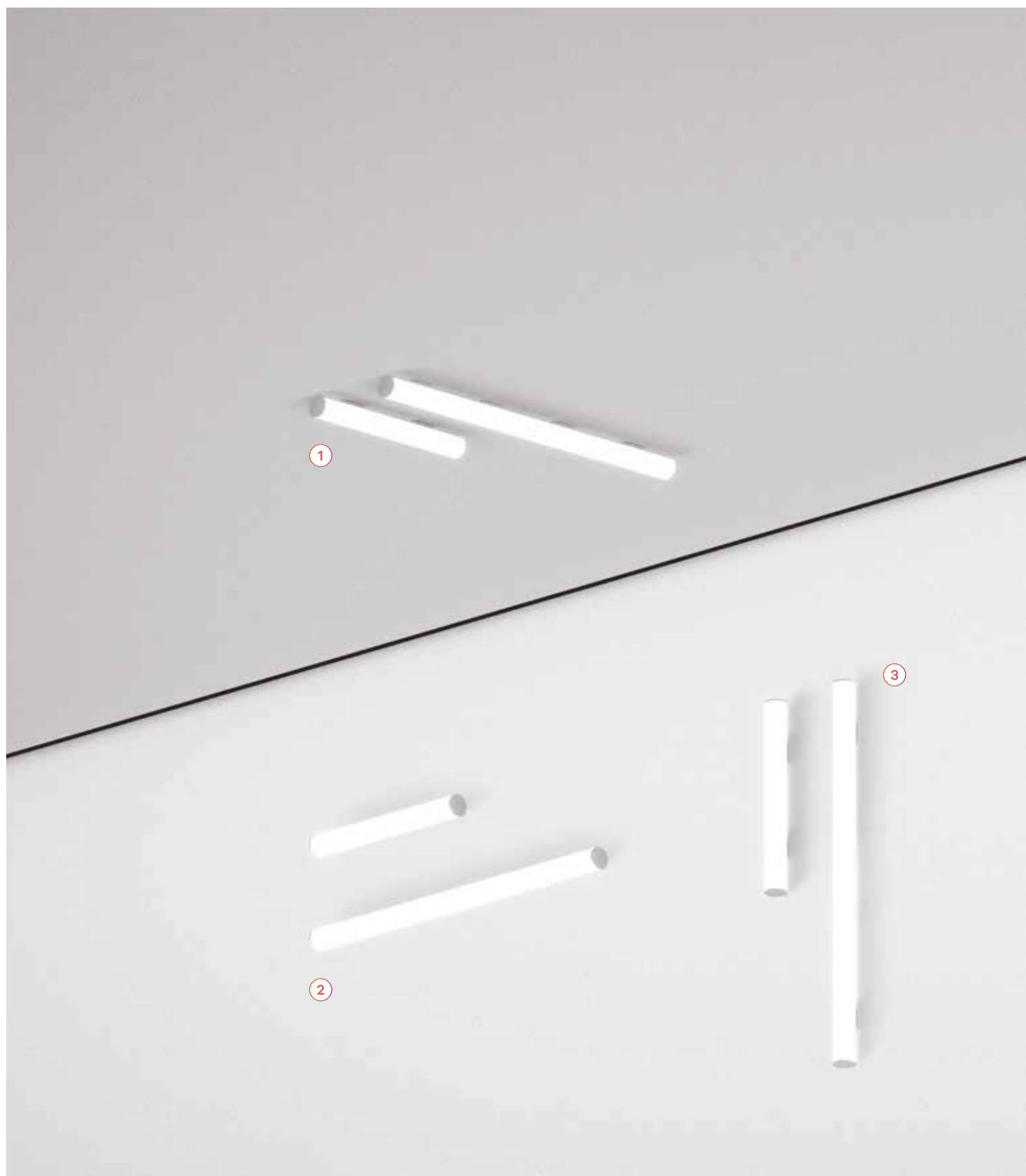



1. Saliente de teto

**2. Saliente de parede
Horizontal**

**3. Saliente de parede
Vertical**

4. Suspensa



Sistema ótico

LUMINÁRIAS
TUBULARES

Escala 1:1



1. bLINE

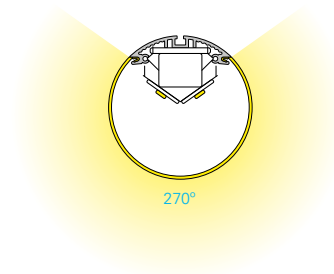
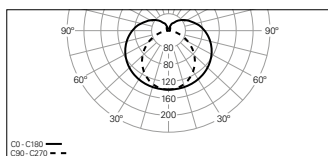

Composição de elementos estruturais

1. Topos

2. Módulos LED

- 2.1 Módulo início (SRT).
- 2.2 Módulo intermédio (MID).
- 2.3 Módulo fim (END).

3. Difusor

4. Kit de união

5. Caixas de alimentação

6. Cabo de alimentação

7. Kit de fixação saliente

8. Suspensão

Módulos disponíveis

(Vista de cima)

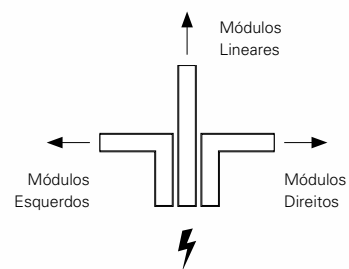

Como estruturar uma linha

(Vista de cima)

— Topo



Módulo início esquerdo (SRT)



Módulo intermédio linear (MID)



Módulo intermédio direito (MID)



Módulo fim esquerdo (END)

— Topo



Defina a sua cor

LUMINÁRIAS
TUBULARES

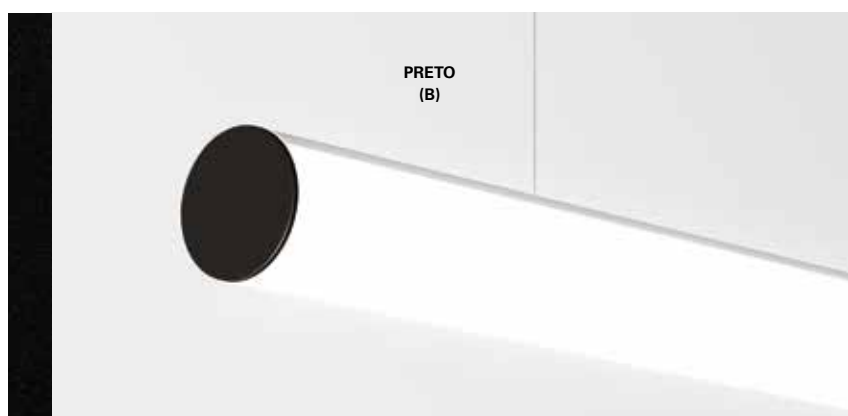
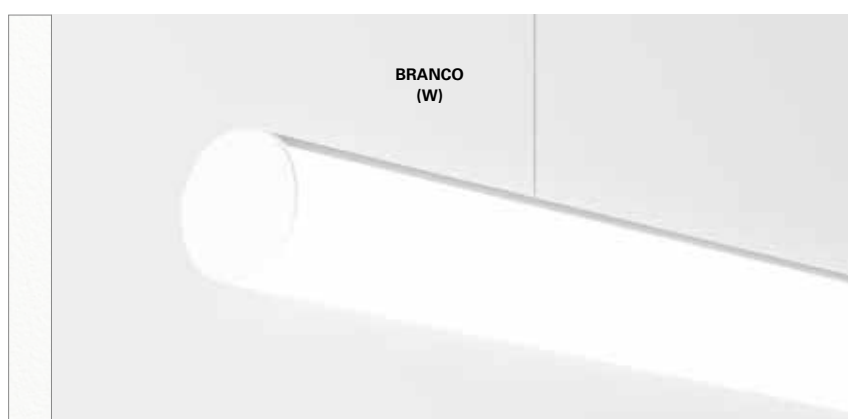



TALEA

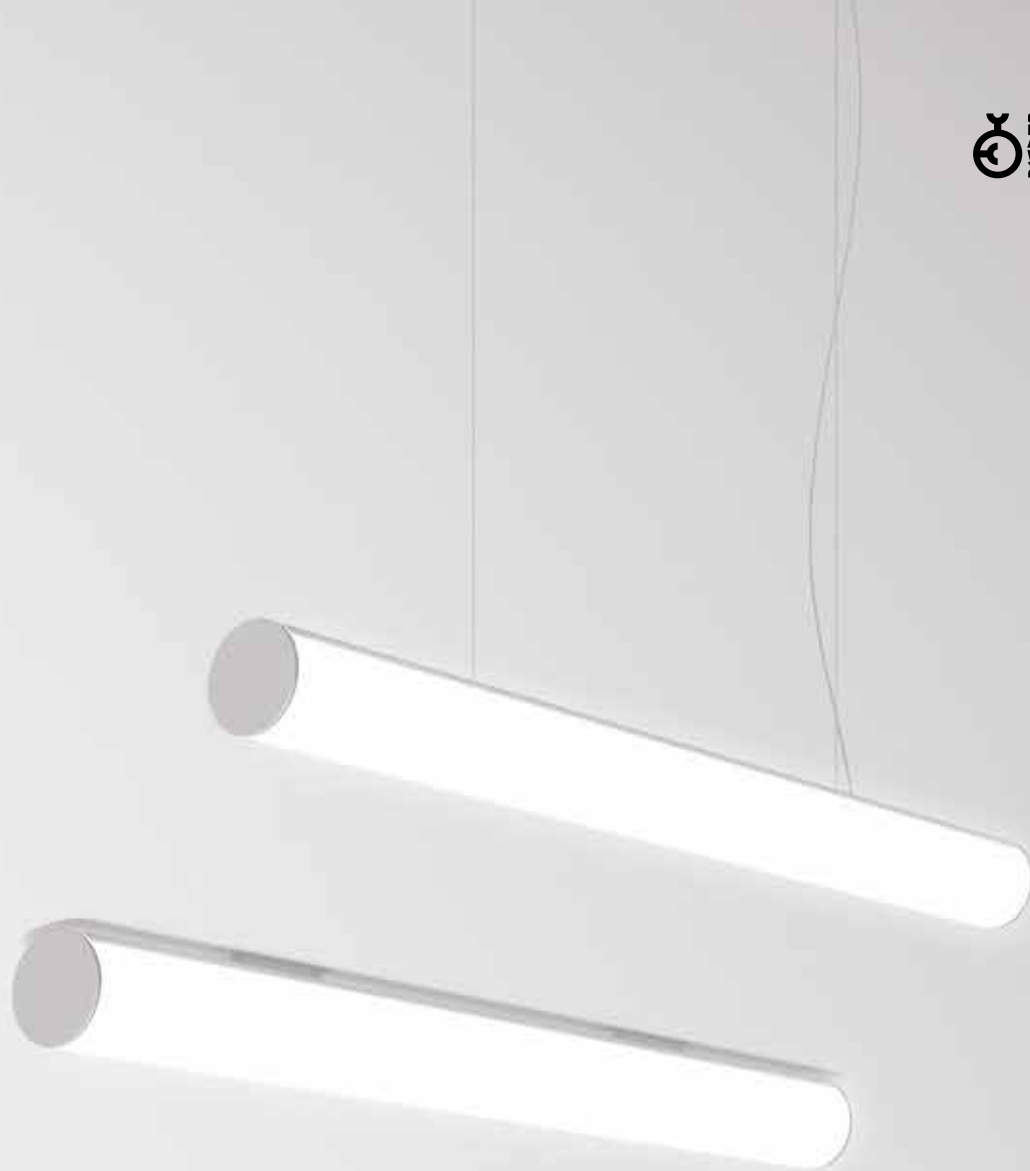

Características do produto

Corpo

Perfil de alumínio extrudido

**Topos**

Policarbonato injetado

230V/50Hz

Acabamento

Anodizado na cor natural



IP 40

Sistema ótico

bLINE - Difusor opalino

Cablagem

Pré-cablagem com cabo de alimentação transparente 1500 mm incluído

960°C

Fonte de luz

LED, RG1, CRI>80, MacAdam Step ≤3

Vida útil LED

80.000h @ L90, B10, Ta 25°C

Fonte de alimentação

Driver LED 220-240V-50/60Hz incluído

01. Selecionar versão



TALEA

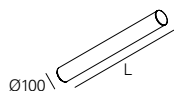

bLINE - Difusor opalino

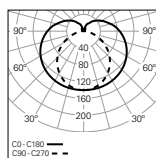

W	lm output	lm/W	Lmm	CÓDIGO*
19	2340	123	598	90438L220▼▲0♦00
27	3510	130	878	90438L230▼▲0♦00
35	4680	134	1158	90438L240▼▲0♦00
43	5850	136	1438	90438L250▼▲0♦00
54	7020	130	1718	90438L260▼▲0♦00
62	8190	132	1998	90438L270▼▲0♦00
70	9360	134	2278	90438L280▼▲0♦00
78	10530	135	2558	90438L290▼▲0♦00
86	11700	136	2838	90438L200▼▲0♦00

*Substitua os símbolos para completar o código

Orientação ▲
LEFT L
RIGHT R

Fonte de alimentação ▼
HF E
DALI H

Cor¹ ▲
□ Branco W
■ Cinzento G
■ Preto B

Emergência ●
No EM 0
EM 3h (K3)² 3

Temp. de Cor ♦
3000K 3
4000K 0

TALEA HRZ

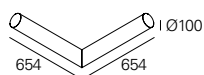

bLINE - Difusor opalino

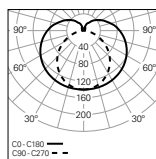

W	lm output	lm/W	CÓDIGO*
35	4680	134	90753▲220▼▲0♦00





TALEA

- Para versão saliente é necessário encomendar sistema de fixação em separado.
- Para versão suspensa é necessário encomendar suspensão e caixa de alimentação em separado.

¹ Cor dos topos.

² Kit de emergência de 3 horas com auto-test. Apenas disponível nas versões HF.

02. Selecionar opções

OPÇÕES	Código*
Kit de fixação saliente	
TALEA (x2)	926400
TALEA HRZ (x4)	926410
Suspensão	
• Para TALEA:	
S5 L1500 mm (x2)	910409
S5 L3000 mm (x2)	910412
S5 L6000 mm (x2)	910421
• Para TALEA HRZ:	
S5 L1500 mm (x3)	910423
S5 L3000 mm (x3)	910424
S5 L6000 mm (x3)	910425
Cabo de alimentação	
L3000 mm - 3 x 0,75 mm ²	940401
L3000 mm - 5 x 0,75 mm ²	940501
L6000 mm - 3 x 0,75 mm ²	940402
L6000 mm - 5 x 0,75 mm ²	940507
Caixa de alimentação circular	
Saliente T24 D95  45  Ø95	978600▲
Encastrar T5 D90  Ø70 33  Ø90	971300▲



*Substitua os símbolos para completar o código

Cor ▲
 Branco W
 Preto B



Detalhes do produto

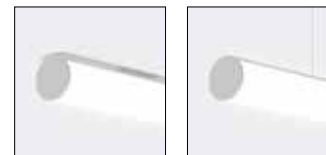

Aplicação saliente

Aplicação suspensa



Aplicação de parede

Talea HRZ



Difusor bLINE

Difusor clip-in



Uniformidade de luz

Kit de fixação saliente



Caixas de alimentação

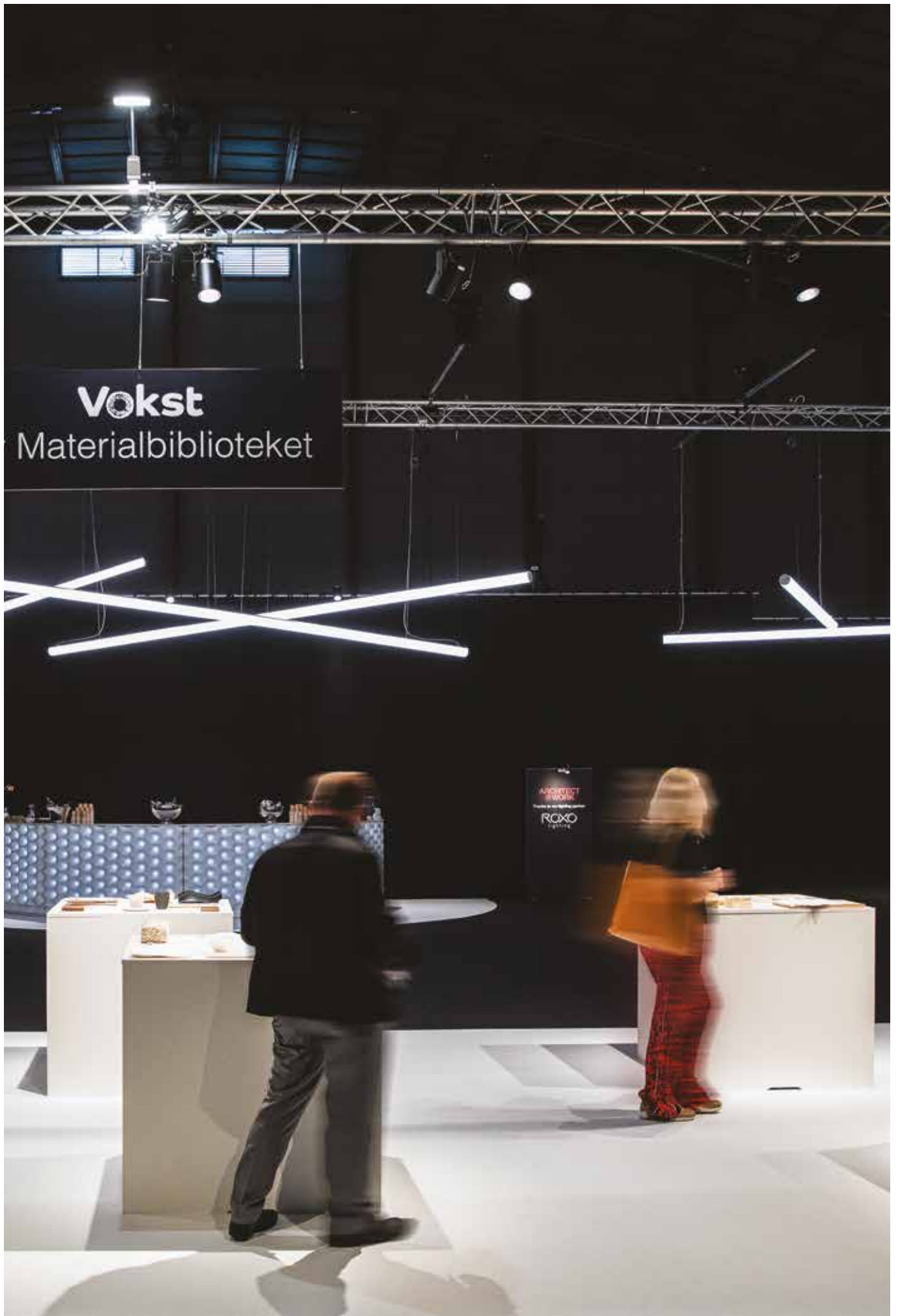

Vokst
Materialbiblioteket

ARKITECT
ROXO

TALEA Line



Características do produto

Corpo

Perfil de alumínio extrudido



Topos

Policarbonato injetado

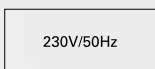

Acabamento

Anodizado na cor natural



Sistema ótico

bLINE - Difusor opalino

Cablagem

Pré-cablagem com cabo de alimentação transparente 1500 mm incluído nos módulos início (SRT)



Fonte de luz

LED, RG1, CRI>80, MacAdam Step ≤ 3

Vida útil LED

80.000h @ L90, B10, Ta 25°C

Fonte de alimentação

Driver LED 220-240V-50/60Hz incluído

01. Seleccionar versão



TALEA Line

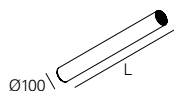

bLINE - Difusor opalino

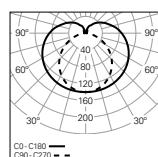

W	lm output	lm/W	Lmm	CÓDIGO*
19	2340	123	590	90439L220▼00♣♣
27	3510	130	870	90439L230▼00♣♣
35	4680	134	1150	90439L240▼00♣♣♣
43	5850	136	1430	90439L250▼00♣♣♣
54	7020	130	1710	90439L260▼00♣♣♣
62	8190	132	1990	90439L270▼00♣♣♣
70	9360	134	2270	90439L280▼00♣♣♣
78	10530	135	2550	90439L290▼00♣♣♣
86	11700	136	2830	90439L200▼00♣♣♣

*Substitua os símbolos para completar o código

Orientação	▲
LEFT	L
RIGHT	R

Fonte de alimentação	▼
HF	E
DALI	H

Emergência	●
No EM	0
EM 3h (K3) ¹	3

TALEA HRZ

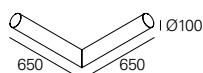

bLINE - Difusor opalino

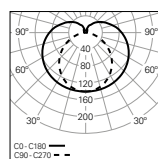

W	lm output	lm/W	CÓDIGO*
35	4680	134	90754▲220▼00♣♣

Temp. de Cor	◆
3000K	3
4000K	0

Módulo	♣
SRT	49
MID	00
END	50

MÓDULOS DISPONÍVEIS

Módulo início (SRT)
 Módulo intermédio (MID)
 Módulo fim (END)

TALEA Line

- Para versão saliente é necessário encomendar sistema de fixação em separado.
- Para versão suspensa é necessário encomendar suspensão e caixa de alimentação em separado.
- Para completar a linha é necessário encomendar start kit e kit de união em separado.
- As dimensões não incluem start kit. Adicione 8 mm ao comprimento para completar a linha.

¹ Kit de emergência de 3 horas com auto-test. Apenas disponível nas versões HF.

02. Selecionar opções

OPÇÕES	Código*
Start kit - topo início/fim	
Branco	922700
Cinzento	922701
Preto	922702
• Dois topos incluídos.	
Kit de união	
HF (x1)	931801
HF + K3 (x1)	931802
DALI (x1)	931800
• União em policarbonato injetado.	
Kit de fixação	
TALEA (x2)	926400
TALEA HRZ (x4)	926410
Suspensão	
• Para TALEA:	
S5 L1500 mm (x2)	910409
S5 L3000 mm (x2)	910412
S5 L6000 mm (x2)	910421
• Para TALEA HRZ:	
S5 L1500 mm (x3)	910423
S5 L3000 mm (x3)	910424
S5 L6000 mm (x3)	910425
Cabo de alimentação	
L3000 mm - 5 x 1,5 mm ²	940001
L6000 mm - 5 x 1,5 mm ²	940002
Caixa de alimentação circular	
Saliente T24 D95  45 l Ø95	978600♣
Encastrar T5 D90  Ø70 33 l Ø90	971300♣



*Substitua os símbolos para completar o código

Cor

<input type="checkbox"/> Branco	W
<input checked="" type="checkbox"/> Preto	B



Detalhes do produto

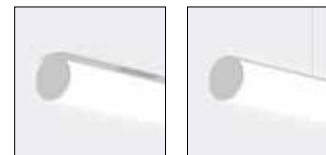

Aplicação saliente

Aplicação suspensa

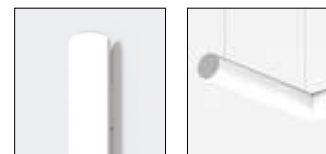

Aplicação de parede

Talea HRZ

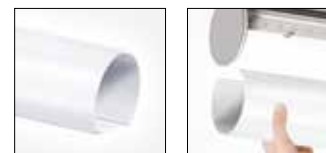

Difusor bLINE

Difusor clip-in



Uniformidade de luz

Kit de fixação saliente



Caixas de alimentação

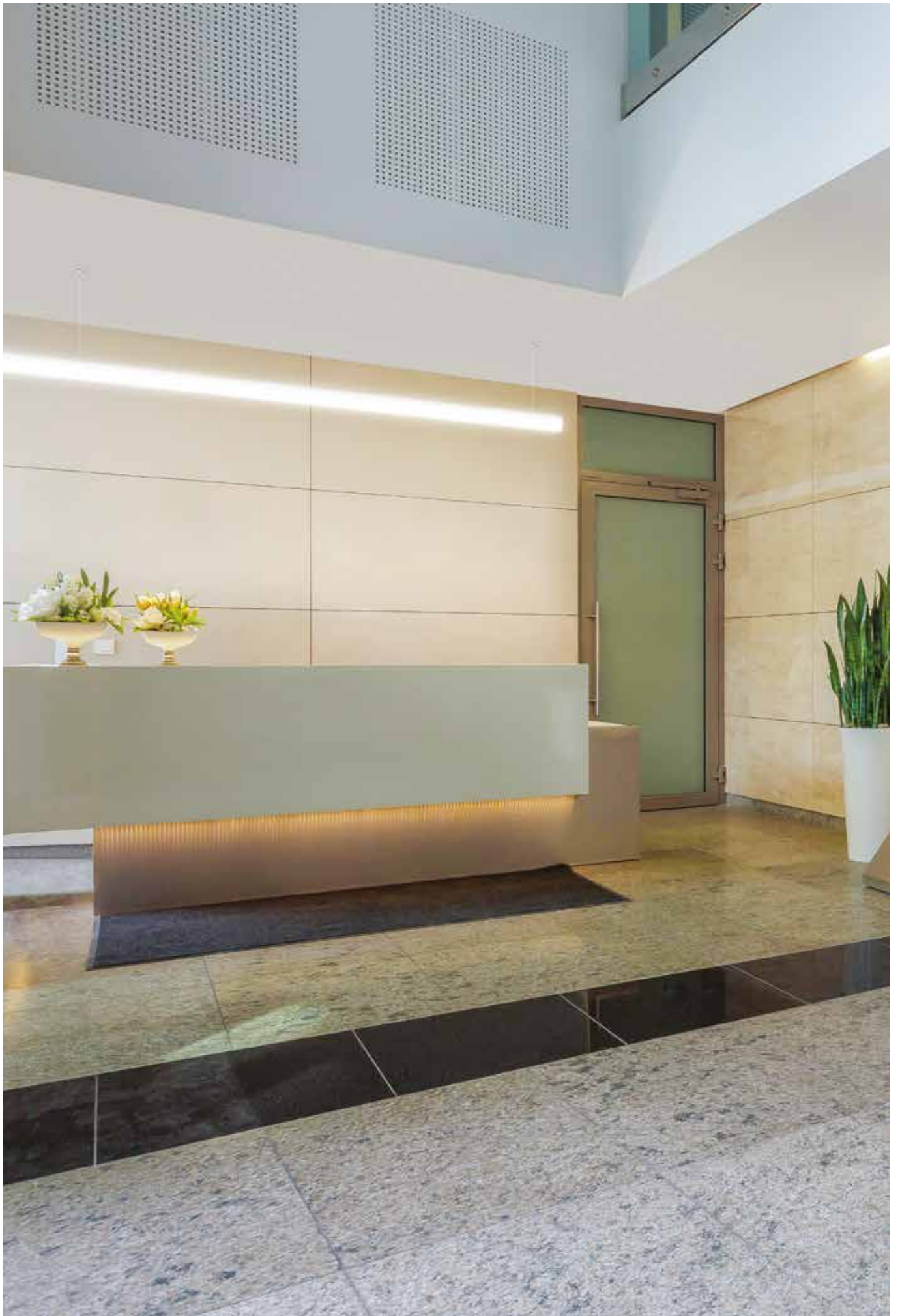

TALEA Glare /C



Características do produto

Corpo

Perfil de alumínio extrudido



Topos

Policarbonato injetado

230V/50Hz

Acabamento

Anodizado na cor natural



IP 40

Sistema ótico

bLINE - Difusor opalino

Fonte de luz

LED, RG1, CRI>80, MacAdam Step ≤3

960°C

Vida útil LED

80.000h @ L90, B10, Ta 25°C

Fonte de alimentação

Driver LED 220-240V-50/60Hz incluído

01. Selecionar versão

TALEA Glare /C

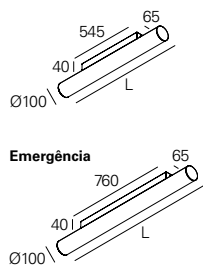

bLINE - Difusor opalino

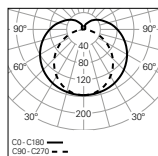

UGR	W	lm output	lm/W	Lmm	CÓDIGO*
≤19	15	1802	120	878	90429L130▼▲◆00
≤19	19	2402	126	1158	90429L140▼▲◆00
≤19	23	3003	131	1438	90429L150▼▲◆00
≤19	27	3604	133	1718	90429L160▼▲◆00
≤19	32	4204	131	1998	90429L170▼▲◆00
≤19	35	4805	137	2278	90429L180▼▲◆00
≤19	41	5405	132	2558	90429L190▼▲◆00
≤19	43	6006	140	2838	90429L100▼▲◆00



*Substitua os símbolos para completar o código

Fonte de alimentação ▼

HF E
DALI H

Cor¹ ▲

□ Branco W
■ Cinzento G
■ Preto B

Emergência ●

No EM 0
EM 3h (K3)² 3

Temp. de Cor ◆

3000K 3
4000K 0



Detalhes do produto



Aplicação saliente



Aplicação de parede



Difusor bLINE



Difusor clip-in



Uniformidade de luz

¹ Cor dos topos.

² Kit de emergência de 3 horas com auto-test. Apenas disponível nas versões HF.





TALEA Glare



Características do produto

Corpo

Perfil de alumínio extrudido



Topos

Policarbonato injetado

230V/50Hz

Acabamento

Anodizado na cor natural



IP 40

Sistema ótico

bLINE - Difusor opalino

Cablagem

Pré-cablagem com cabo de alimentação transparente 1500 mm incluído

960°C

Fonte de luz

LED, RG1, CRI>80, MacAdam Step ≤3

Vida útil LED

80.000h @ L90, B10, Ta 25°C

Fonte de alimentação

Não incluída

01. Selecionar versão



TALEA Glare

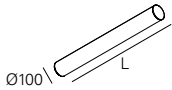

bLINE - Difusor opalino

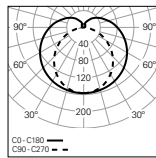

UGR	W	lm output	lm/W	Lmm	CÓDIGO*
≤19	15	1802	120	878	90428L1300♣♦00
≤19	19	2402	126	1158	90428L1400♣♦♦00
≤19	23	3003	131	1438	90428L1500♣♦♦00
≤19	27	3604	133	1718	90428L1600♣♦♦00
≤19	32	4204	131	1998	90428L1700♣♦♦00
≤19	35	4805	137	2278	90428L1800♣♦♦00
≤19	41	5405	132	2558	90428L1900♣♦♦00
≤19	43	6006	140	2838	90428L1000♣♦♦00

*Substitua os símbolos para completar o código

Cor ¹	W
□ Branco	W
■ Cinzento	G
■ Preto	B

Emergência	0
No EM	0
EM 3h (K3) ²	3

TALEA Glare

• Para completar o produto é necessário encomendar suspensão e caixa de alimentação em separado.

Temp. de Cor	♦
3000K	3
4000K	0

02. Selecionar caixa de alimentação

Encastrar - No EM

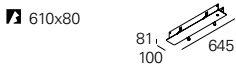

Encastrar - EM 3h (K3)

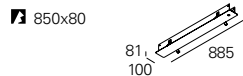

Saliente - No EM

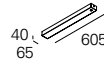

Saliente - EM 3h (K3)

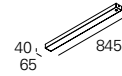

HF

	CÓDIGO*
L878	978401♣
L1158	978402♣
L1438	978403♣
L1718	978404♣
L1998	978405♣
L2278	978406♣
L2558	978407♣
L2838	978408♣

HF + EM 3h (K3)

	CÓDIGO*
L1158	978432♣
L1438	978433♣
L1718	978434♣
L1998	978435♣
L2278	978436♣
L2558	978437♣
L2838	978438♣

HF

	CÓDIGO*
L878	978201♣
L1158	978202♣
L1438	978203♣
L1718	978204♣
L1998	978205♣
L2278	978206♣
L2558	978207♣
L2838	978208♣

HF + EM 3h (K3)

	CÓDIGO*
L1158	978232♣
L1438	978233♣
L1718	978234♣
L1998	978235♣
L2278	978236♣
L2558	978237♣
L2838	978238♣

DALI

	CÓDIGO*
L878	978501♣
L1158	978502♣
L1438	978503♣
L1718	978504♣
L1998	978505♣
L2278	978506♣
L2558	978507♣
L2838	978508♣

DALI + EM 3h (K3)

	CÓDIGO*
L1158	978532♣
L1438	978533♣
L1718	978534♣
L1998	978535♣
L2278	978536♣
L2558	978537♣
L2838	978538♣

DALI

	CÓDIGO*
L878	978301♣
L1158	978302♣
L1438	978303♣
L1718	978304♣
L1998	978305♣
L2278	978306♣
L2558	978307♣
L2838	978308♣

DALI + EM 3h (K3)

	CÓDIGO*
L1158	978332♣
L1438	978333♣
L1718	978334♣
L1998	978335♣
L2278	978336♣
L2558	978337♣
L2838	978338♣

CAIXA DE ALIMENTAÇÃO

- Fonte de alimentação incluída na caixa de alimentação.
- A distância máxima entre a caixa de alimentação e o produto são 3000 mm.

¹ Cor dos topos.

² Preparado para telecomando.

03. Selecionar opções

OPÇÕES	Código
Suspensão	
S5 L1500 mm (x2)	910409
S5 L3000 mm (x2)	910412
Cabo de alimentação	
• HF/DALI L3000 mm - 2 x 0,75 mm ²	942801
• HF/DALI + EM 3h (K3) L3000 mm - 5 x 0,75 mm ²	940501



Detalhes do produto

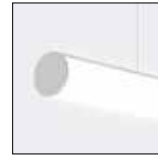

Aplicação suspensa



Difusor bLINE



Difusor clip-in



Uniformidade de luz



Caixas de alimentação



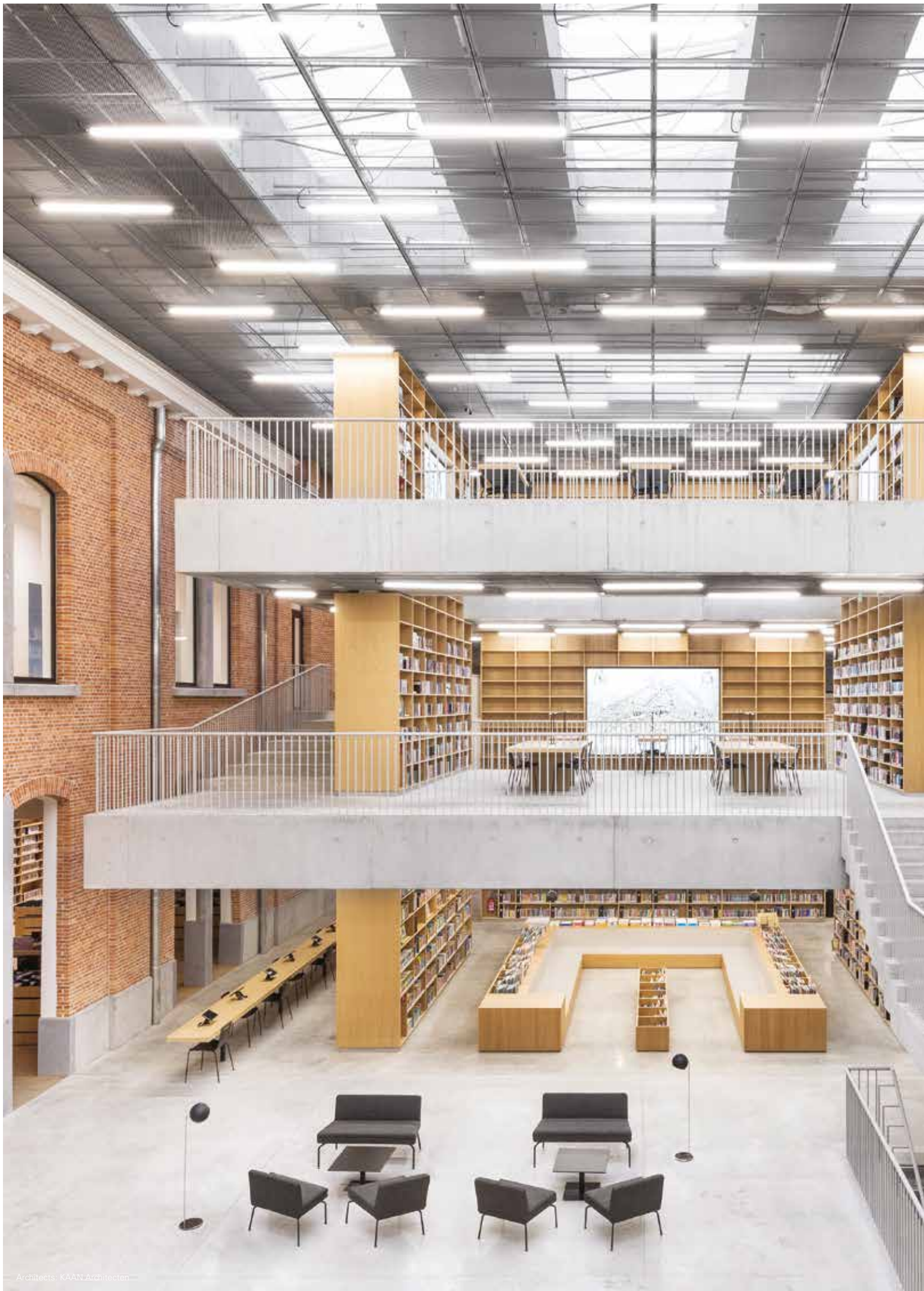

Luminárias
tubulares

TTP



TTP 50
708



TTP 50 Line
712



TTP 70
716



TTP 70 Line
720



TTP 100
724



TTP 100 Line
728



Tipos de aplicação

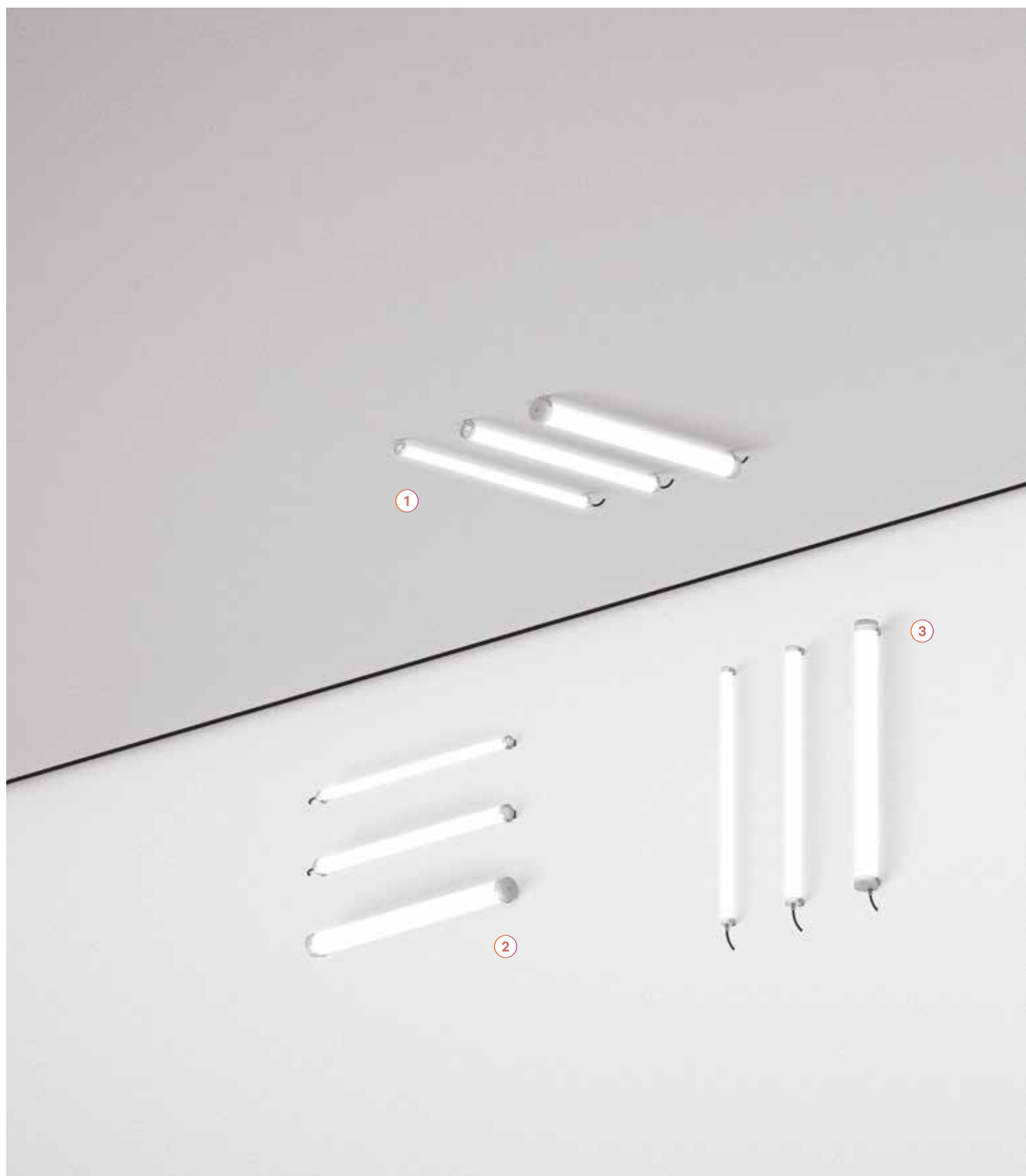

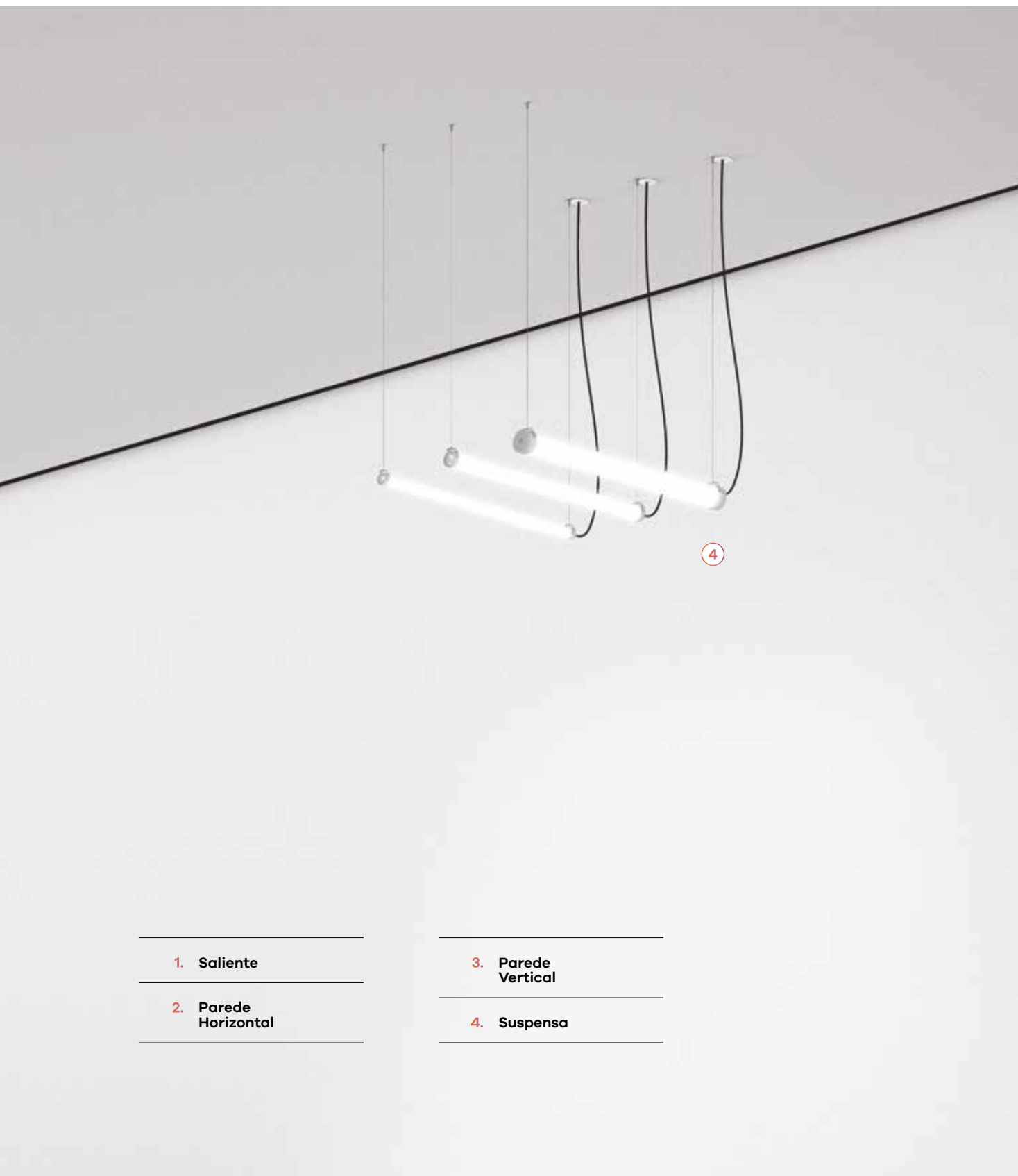

Uma escolha versátil para o seu projeto



TTP 50
≈ Ø50 mm



TTP 70
≈ Ø70 mm



TTP 100
≈ Ø100 mm



	TTP 50	TTP 50 Line	TTP 70	TTP 70 Line	TTP 100	TTP 100 Line
MEDIDAS	≈ Ø50 mm	≈ Ø50 mm	≈ Ø70 mm	≈ Ø70 mm	≈ Ø100 mm	≈ Ø100 mm
≈650 mm	•	•	•	•	•	•
≈900 mm	•	•	•	•	•	•
≈1200 mm	•	•	•	•	•	•
≈1500 mm	•	•	•	•	•	•
Sensor						
≈750 mm	•		•		•	
≈830 mm		•		•		•
≈1040 mm	•		•		•	
≈1110 mm		•		•		•
≈1320 mm	•		•		•	
≈1390 mm		•		•		•
≈1600 mm	•		•		•	
≈1670 mm		•		•		•



1. TUP

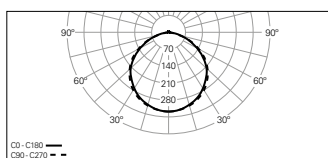

2. TOP

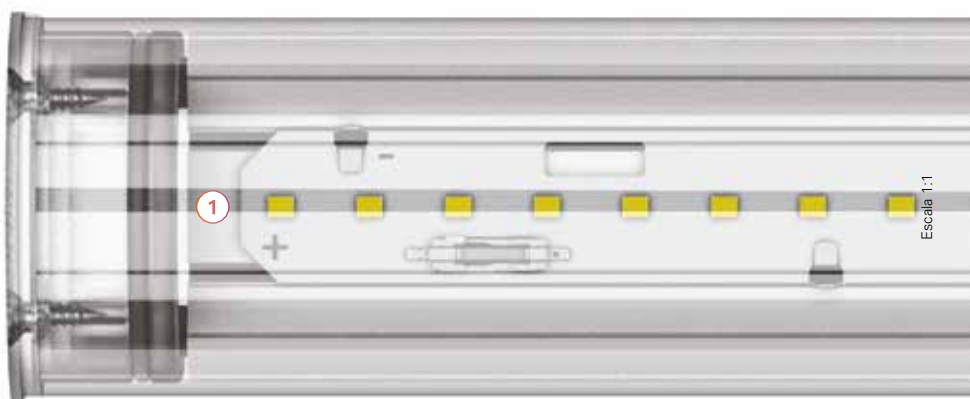
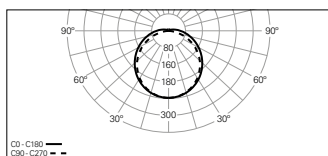

Minimalismo e tecnologia

1. Versão standard

Versões individuais pré-eletrificadas com cabo H07RN-F de 1500 mm e bucim plástico. Cabo de alimentação não incluído nas versões de linha contínua.

2. Topos

A TTP 50 e TTP 70 está disponível com topos em policarbonato transparente injetado ou inox. A TTP 100 está disponível com topos em alumínio ou inox.



3. Bucins opcionais

- 3.1 Bucim metálico
- 3.2 Bucim metálico ventilado

4. Abraçadeiras

- 4.1 Abraçadeira em PVC
- 4.2 Abraçadeira em inox com clip
- 4.3 Abraçadeira em inox A1
- 4.4 Abraçadeira em inox A2
- 4.5 Abraçadeira em inox com fecho

Todos as abraçadeiras podem ser utilizadas para aplicação saliente, suspensa ou de parede.

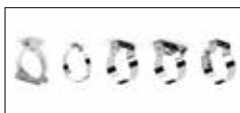

5. Suspensão e caixa de alimentação

Suspensões ajustáveis de 1500, 3000 ou 6000 mm compatíveis com todas as abraçadeiras disponíveis.

Caixas de alimentação de encastrar ou saliente disponíveis na cor branca ou preta.



- **LED**
SDCM MacAdam ≤ 3 , temperatura de cor 3000K / 4000K, CRI > 80 e vida útil de 80.000h L90 B10.

- **Tunable White**
Versões Tunable White disponíveis com um espectro de branco de 2700K até 6500K.



- **TUP ou TOP**
Sistema ótico de alta tecnologia com versão transparente (TUP), ou opalina (TOP) para uma luz suave e uniforme sem pontos visíveis.



- **Kit de emergência**
Kit de emergência de 3 horas. Disponível nas versões HF a partir de 1180 mm.

- **Isento de risco fotobiológico**
Grupo de risco fotobiológico 0 de acordo com IEC 62471.

• Marcações / Certificações





Descubra os pormenores

- **Flexibilidade de linhas contínuas**

Versões de linha contínua disponíveis para TTP 50, 70 e 100, permitindo até 35 luminárias por linha.

Disponível em luminárias iniciais/intermédias (SRT/MID) equipadas com dois buçins e luminárias finais (END) equipadas com um buçim.

- **Índice Proteção**

Graças ao IP68, as luminárias estão totalmente protegidas contra pó e efeitos prolongados de imersão a baixa pressão. Luminária com IK10, que garante proteção contra impactos mecânicos até 20 joules.

- **Versões HO e LO disponíveis**

Todas as luminárias estão disponíveis em versão low output (LO) até 163 lm/W e high output (HO) até 142 lm/W.

- **Sensor**

Sensor de presença disponível para versões individuais ou linha contínua.

Numa linha contínua, apenas a primeira luminária inclui um sensor que comunica com até 16 luminárias por linha.

Módulos disponíveis

(Vista de cima)

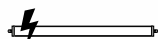

Módulo início / intermédio (SRT/MID)

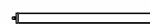

Módulo fim (END)

Como estruturar uma linha

(Vista de cima)

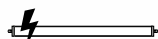

Módulo início / intermédio (SRT/MID)

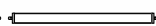

Módulo início / intermédio (SRT/MID)

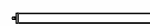

Módulo fim (END)



Saliente ou parede



Suspensa



Sensor





Architects: KAAAN Architecten



TTP 50



Características do produto

Corpo

Tubo de policarbonato

Acabamento

Interior revestido a epóxi-poliéster em branco mate

Sistema de fixação

Abraçadeiras não incluídas

Sistema ótico

TUP - Difusor transparente
TOP - Difusor opalino

Cablagem

Cabo H07RN-F de 1500 mm com buçim plástico incluído

Fonte de luz

LED, RG0, CRI>80, MacAdam Step ≤3

Vida útil LED

80.000h @ L90, B10, Ta 25°C

Fonte de alimentação

Driver LED 220-240V-50/60Hz incluído

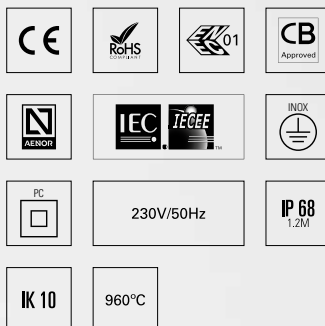

01. Selecionar versão



LOW OUTPUT

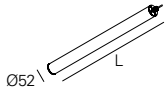

TUP - Difusor transparente

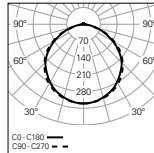

W	lm output	lm/W	Lmm	CÓDIGO*
12	1868	156	620	90473L060▼▲0◆00
17	2802	165	900	90473L090▼▲0◆00
21	3735	178	1180	90473L120▼▲0◆00
26	4669	180	1460	90473L150▼▲0◆00

TOP - Difusor opalino

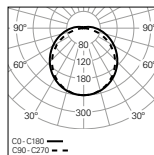

W	lm output	lm/W	Lmm	CÓDIGO*
12	1573	131	620	90472L060▼▲0◆00
17	2359	139	900	90472L090▼▲0◆00
21	3146	150	1180	90472L120▼▲0◆00
26	3932	151	1460	90472L150▼▲0◆00

*Substitua os símbolos para completar o código

Fonte de alimentação ▼
HF E
DALI H

Topos ▲
Policarbonato¹ 0
Inox² S

Emergência ●
No EM 0
EM 3h (K3)³ 3

Temp. de Cor ◆
3000K 3
4000K 0
Tunable White⁴ T

HIGH OUTPUT

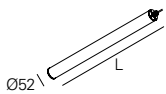

TUP - Difusor transparente

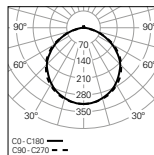

W	lm output	lm/W	Lmm	CÓDIGO*
26	3982	153	620	90471L060▼▲0◆00
40	5973	149	900	90471L090▼▲0◆00
51	7964	156	1180	90471L120▼▲0◆00
63	9954	158	1460	90471L150▼▲0◆00

TOP - Difusor opalino

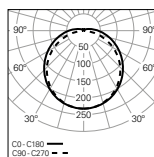

W	lm output	lm/W	Lmm	CÓDIGO*
26	3419	132	620	90470L060▼▲0◆00
40	5129	128	900	90470L090▼▲0◆00
51	6838	134	1180	90470L120▼▲0◆00
63	8548	136	1460	90470L150▼▲0◆00

LOW OUTPUT | HIGH OUTPUT

- Para completar o produto é necessário encomendar sistema de fixação em separado.
- Para versão suspensa é necessário encomendar suspensão e caixa de alimentação em separado.
- A luminária com sensor possui mais 130 mm de comprimento do que a medida standard.







¹ Topos injetados em policarbonato transparente. O produto é classe II.

² Topos em inox. O produto é classe I.

³ Kit de emergência de 3 horas com auto-test. Apenas disponível nas versões HF.

⁴ Apenas disponível nas versões DALI sem kit de emergência (No EM).

02. Selecionar opções

OPÇÕES	Código*
SwitchDIM Tunable White	926600
• Permite controlar no máximo 20 luminárias, por cada SwitchDIM Tunable White.	
Sistema de fixação	
Abraçadeira PVC D50 (x2)  26 69 17	915001
Abraçadeira inox D50 clip (x2)  14 60 10	915003
Abraçadeira inox A1 D50 (x2)  36 65 20	915303
Abraçadeira inox A2 D50 (x2)  56 63 20	915305
Abraçadeira inox D50 com fecho (x2)  29 67 20	915304
Suspensão	
S4 L1500 mm (x2)	910200
Caixa de alimentação ¹	
Saliente T24 D95  45 Ø95	978600▲
Encastrar T5 D90  Ø70 33 Ø90	971300▲
Bucim para versões HF	
Metálico M16 (x1)	925000
Metálico ventilado M16 (x1)	926700
Bucim para versões DALI	
Metálico M20 (x1)	925001
Metálico ventilado M20 (x1)	926701
Sensor	
• Sob consulta.	
• Área de deteção: 100%. Tempo de espera: 5s. Limite de luz natural: desativo. Para outras programações consulte o manual do sensor.	
Sensor e kit de emergência (3 Horas)	
• Sob consulta.	



*Substitua os símbolos para completar o código

Cor

<input type="checkbox"/> Branco	W
<input checked="" type="checkbox"/> Preto	B



Detalhes do produto



Aplicação saliente

Aplicação suspensa

Aplicação de parede



Difusor opalino

Difusor transparente

Topos de policarbonato transparente



Topos inox

Abraçadeira PVC D50

Abraçadeira inox D50 clip



Abraçadeira inox A1 D50

Abraçadeira inox A2 D50

Abraçadeira inox D50 com fecho



Caixas de alimentação

Bucim plástico

Bucim metálico



Bucim metálico ventilado

Sensor

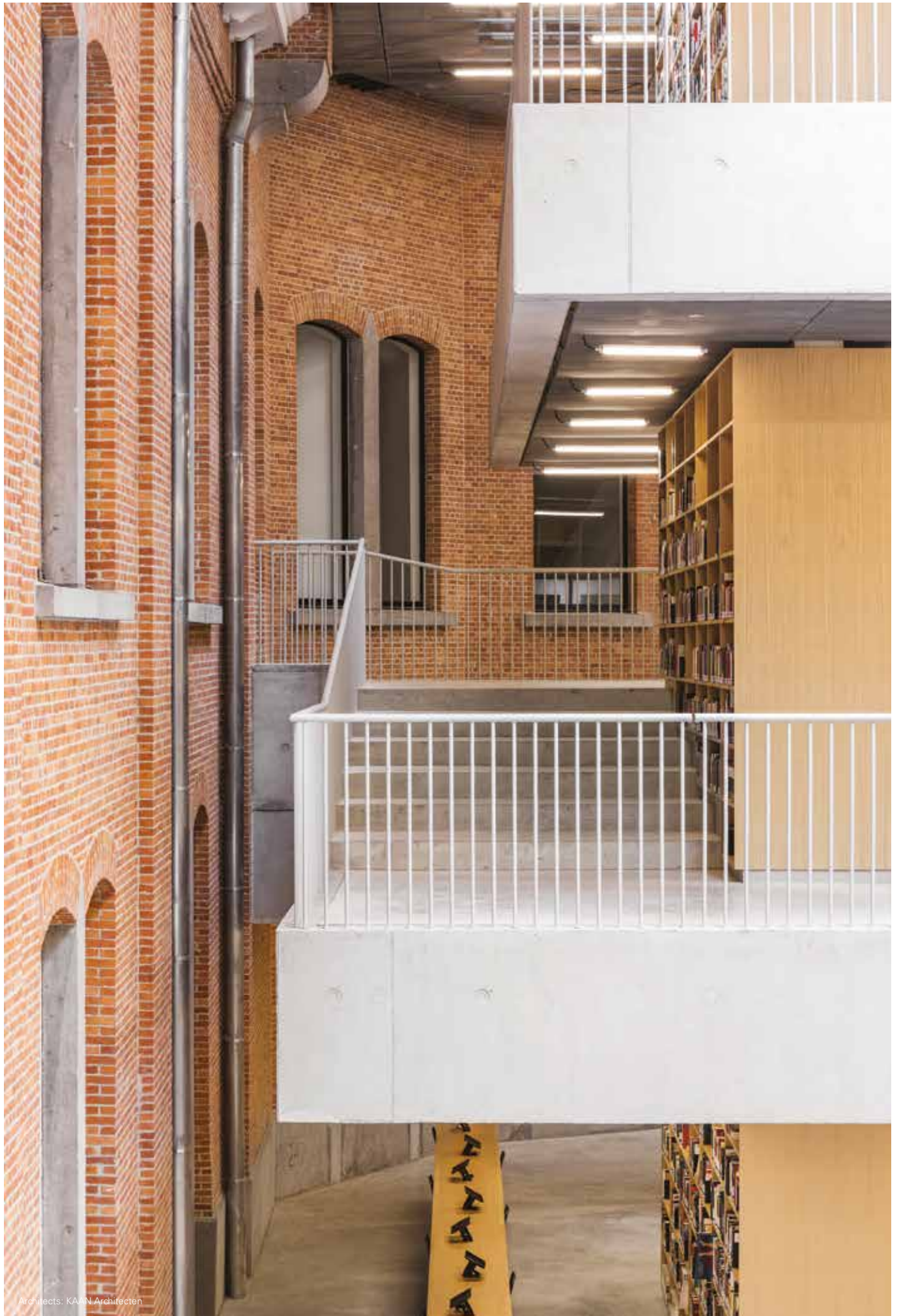

Architects: KAAN Architecten

TTP 50 Line



Características do produto

Corpo

Tubo de policarbonato

Acabamento

Interior revestido a epóxi-poliéster em branco mate

Sistema de fixação

Abraçadeiras não incluídas

Sistema ótico

TUP - Difusor transparente
TOP - Difusor opalino

Cablagem

Bucim plástico e cablagem interna de linha contínua incluído
Cabo H07RN-F de 1500 mm não incluído

Fonte de luz

LED, RG0, CRI>80, MacAdam Step ≤3

Vida útil LED

80.000h @ L90, B10, Ta 25°C

Fonte de alimentação

Driver LED 220-240V-50/60Hz incluído

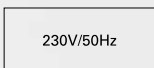

01. Selecionar versão



LOW OUTPUT

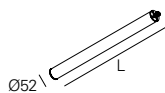

TUP - Difusor transparente

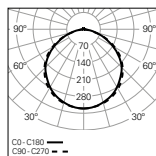

W	lm output	lm/W	Lmm	CÓDIGO*
12	1868	156	620	90485L060▼▲0◆♣
17	2802	165	900	90485L090▼▲0◆♣
21	3735	178	1180	90485L120▼▲0◆♣
26	4669	180	1460	90485L150▼▲0◆♣

TOP - Difusor opalino

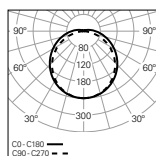

W	lm output	lm/W	Lmm	CÓDIGO*
12	1573	131	620	90484L060▼▲0◆♣
17	2359	139	900	90484L090▼▲0◆♣
21	3146	150	1180	90484L120▼▲0◆♣
26	3932	151	1460	90484L150▼▲0◆♣

*Substitua os símbolos para completar o código

Fonte de alimentação ▼
HF E
DALI H

Topos ▲
Policarbonato¹ 0
Inox² S

Temp. de Cor ◆
3000K 3
4000K 0
Tunable White³ T

Módulo ♣
SRT/MID 58
END 50

HIGH OUTPUT

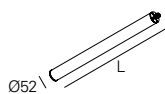

TUP - Difusor transparente

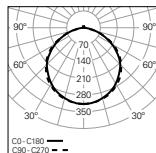

W	lm output	lm/W	Lmm	CÓDIGO*
26	3982	153	620	90483L060▼▲0◆♣
40	5973	149	900	90483L090▼▲0◆♣
51	7964	156	1180	90483L120▼▲0◆♣
63	9954	158	1460	90483L150▼▲0◆♣

TOP - Difusor opalino

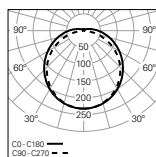

W	lm output	lm/W	Lmm	CÓDIGO*
26	3419	132	620	90482L060▼▲0◆♣
40	5129	128	900	90482L090▼▲0◆♣
51	6838	134	1180	90482L120▼▲0◆♣
63	8548	136	1460	90482L150▼▲0◆♣

MÓDULOS DISPONÍVEIS

◀ Módulo início / intermédio (SRT/MID) Módulo fim (END) ▶

LOW OUTPUT | HIGH OUTPUT

- Para completar o produto é necessário encomendar sistema de fixação em separado.
- Para versão suspensa é necessário encomendar suspensão e caixa de alimentação em separado.
- A luminária com sensor possui mais 215 mm de comprimento do que a medida standard.
- O número máximo de luminárias high output que se pode ligar em linha é 15. Com sensor o número máximo é 9.
- O número máximo de luminárias low output que se pode ligar em linha é 35. Com sensor o número máximo é 16.

¹ Topos injetados em policarbonato transparente. O produto é classe II.

² Topos em inox. O produto é classe I.

³ Apenas disponível nas versões DALI. Para os comprimentos de L620 e L900 mm, Tunable White é apenas aplicável para versões fim de linha (END).

02. Selecionar opções

OPÇÕES	Código*
SwitchDIM Tunable White	926600
• Permite controlar no máximo 20 luminárias, por cada SwitchDIM Tunable White.	
Sistema de fixação	
Abraçadeira PVC D50 (x2)	26 169 17 915001
Abraçadeira inox D50 clip (x2)	14 160 10 915003
Abraçadeira inox A1 D50 (x2)	36 165 20 915303
Abraçadeira inox A2 D50 (x2)	56 163 20 915305
Abraçadeira inox D50 com fecho (x2)	29 167 20 915304
Suspensão	
S4 L1500 mm (x2)	910200
S4 L3000 mm (x2)	910204
S4 L6000 mm (x2)	910208
Caixa de alimentação ¹	
Saliente T24 D95	45 Ø95 978600
Encastrar T5 D90	Ø70 33 Ø90 971300
Bucim para versões HF	
• Para todos os módulos início/intermédio (SRT/MID):	
Metálico M16 (x2)	925010
Metálico ventilado M16 (x2)	926710
• Para todos os módulos fim (END):	
Metálico M16 (x1)	925000
Metálico ventilado M16 (x1)	926700
Bucim para versões DALI	
• Para todos os módulos início/intermédio (SRT/MID):	
Metálico M20 (x2)	925011
Metálico ventilado M20 (x2)	926711
• Para todos os módulos fim (END):	
Metálico M20 (x1)	925001
Metálico ventilado M20 (x1)	926701
Sensor	
• Sob consulta.	
• Área de deteção: 100%. Tempo de espera: 5s. Limite de luz natural: desativo. Para outras programações consulte o manual do sensor.	



*Substitua os símbolos para completar o código

Cor

<input type="checkbox"/> Branco	W
<input checked="" type="checkbox"/> Preto	B



Detalhes do produto





TTP 70



Características do produto

Corpo

Tubo de policarbonato



Acabamento

Interior revestido a epóxi-poliéster
em branco mate



Sistema de fixação

Abraçadeiras não incluídas

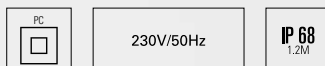

Sistema ótico

TUP - Difusor transparente
TOP - Difusor opalino



Cablagem

Cabo H07RN-F de 1500 mm com buçim
plástico incluído

Fonte de luz

LED, RG0, CRI>80, MacAdam Step ≤3

Vida útil LED

80.000h @ L90, B10, Ta 25°C

Fonte de alimentação

Driver LED 220-240V-50/60Hz incluído

01. Selecionar versão



LOW OUTPUT

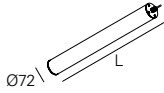

TUP - Difusor transparente

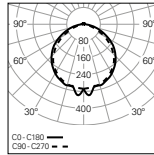

W	lm output	lm/W	Lmm	CÓDIGO*
12	1789	149	620	90477L060▼▲0◆00
17	2684	158	900	90477L090▼▲0◆00
21	3578	170	1180	90477L120▼▲0◆00
26	4473	172	1460	90477L150▼▲0◆00

TOP - Difusor opalino

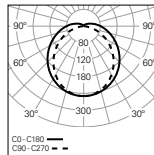

W	lm output	lm/W	Lmm	CÓDIGO*
12	1691	141	620	90476L060▼▲0◆00
17	2536	149	900	90476L090▼▲0◆00
21	3382	161	1180	90476L120▼▲0◆00
26	4227	163	1460	90476L150▼▲0◆00

*Substitua os símbolos para completar o código

Fonte de alimentação ▼
HF E
DALI H

Topos ▲
Policarbonato¹ 0
Inox² S

Emergência ●
No EM 0
EM 3h (K3)³ 3

Temp. de Cor ◆
3000K 3
4000K 0
Tunable White⁴ T

HIGH OUTPUT

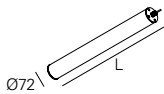

TUP - Difusor transparente

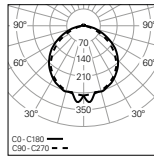

W	lm output	lm/W	Lmm	CÓDIGO*
26	3765	145	620	90475L060▼▲0◆00
40	5648	141	900	90475L090▼▲0◆00
51	7531	148	1180	90475L120▼▲0◆00
63	9413	149	1460	90475L150▼▲0◆00

TOP - Difusor opalino

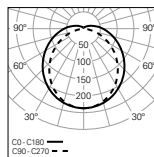

W	lm output	lm/W	Lmm	CÓDIGO*
26	3506	135	620	90474L060▼▲0◆00
40	5259	131	900	90474L090▼▲0◆00
51	7011	137	1180	90474L120▼▲0◆00
63	8764	139	1460	90474L150▼▲0◆00

LOW OUTPUT | HIGH OUTPUT

- Para completar o produto é necessário encomendar sistema de fixação em separado.
- Para versão suspensa é necessário encomendar suspensão e caixa de alimentação em separado.
- A luminária com sensor possui mais 130 mm de comprimento do que a medida standard.

¹ Topos injetados em policarbonato transparente. O produto é classe II.

² Topos em inox. O produto é classe I.

³ Kit de emergência de 3 horas com auto-test. Apenas disponível nas versões HF.

⁴ Apenas disponível nas versões DALI sem kit de emergência (No EM).

02. Selecionar opções

OPÇÕES	Código*
SwitchDIM Tunable White • Permite controlar no máximo 20 luminárias, por cada SwitchDIM Tunable White.	926600
Sistema de fixação	
Abracadeira inox A1 D70 (x2) 	915403
Abracadeira inox A2 D70 (x2) 	915405
Abracadeira inox D70 com fecho (x2) 	915404
Suspensão S4 L1500 mm (x2)	910200
Caixa de alimentação ¹	
Saliente T24 D95 	978600▲
Encastrar T5 D90 	971300▲
Bucim para versões HF	
Metálico M16 (x1)	925000
Metálico ventilado M16 (x1)	926700
Bucim para versões DALI	
Metálico M20 (x1)	925001
Metálico ventilado M20 (x1)	926701
Sensor • Sob consulta. • Área de deteção: 100%. Tempo de espera: 5s. Limite de luz natural: desativo. Para outras programações consulte o manual do sensor.	
Sensor e kit de emergência (3 Horas) • Sob consulta.	



*Substitua os símbolos para completar o código

Cor
 Branco W
 Preto B



Detalhes do produto

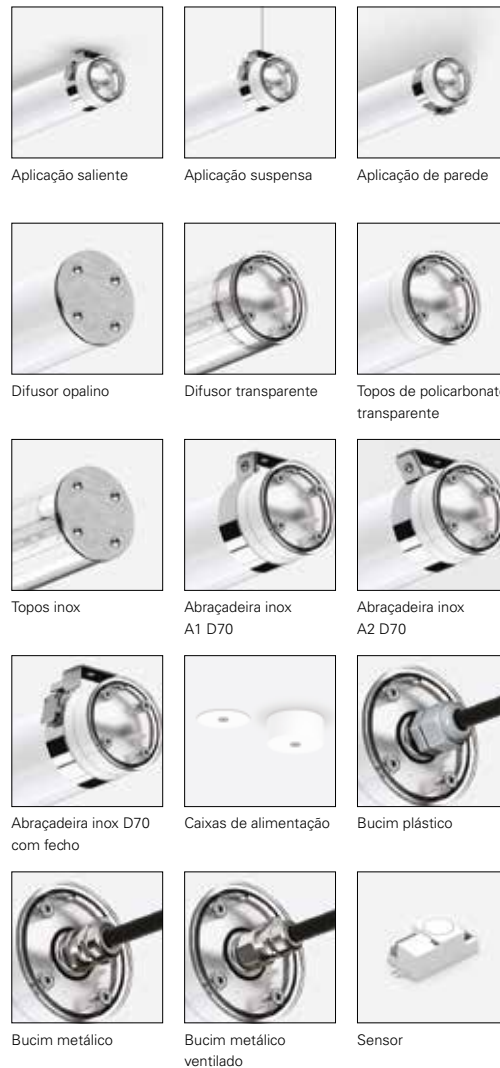

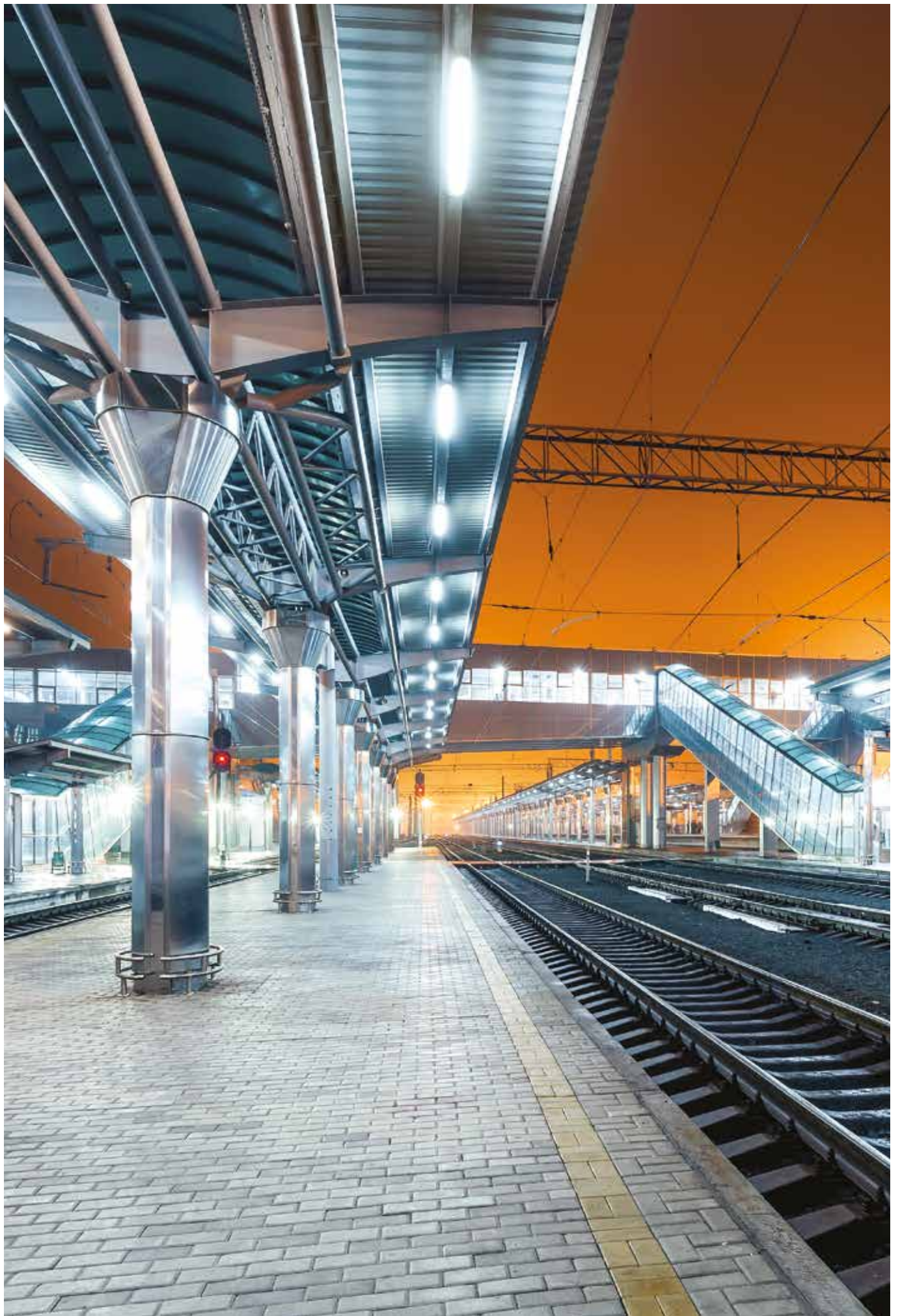

TTP 70 Line



Características do produto

Corpo

Tubo de policarbonato

Acabamento

Interior revestido a epóxi-poliéster em branco mate

Sistema de fixação

Abraçadeiras não incluídas

Sistema ótico

TUP - Difusor transparente
TOP - Difusor opalino

Cablagem

Bucim plástico e cablagem interna de linha contínua incluído
Cabo H07RN-F de 1500 mm não incluído

Fonte de luz

LED, RG0, CRI>80, MacAdam Step ≤3

Vida útil LED

80.000h @ L90, B10, Ta 25°C

Fonte de alimentação

Driver LED 220-240V-50/60Hz incluído

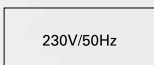

01. Selecionar versão



LOW OUTPUT

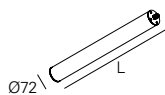

TUP - Difusor transparente

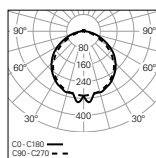

W	lm output	lm/W	Lmm	CÓDIGO*
12	1789	149	620	90489L060▼▲0♣♣
17	2684	158	900	90489L090▼▲0♣♣
21	3578	170	1180	90489L120▼▲0♣♣
26	4473	172	1460	90489L150▼▲0♣♣

TOP - Difusor opalino

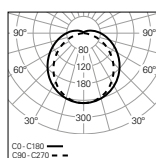

W	lm output	lm/W	Lmm	CÓDIGO*
12	1691	141	620	90488L060▼▲0♣♣
17	2536	149	900	90488L090▼▲0♣♣
21	3382	161	1180	90488L120▼▲0♣♣
26	4227	163	1460	90488L150▼▲0♣♣

*Substitua os símbolos para completar o código

Fonte de alimentação ▼
HF E
DALI H

Topos ▲
Policarbonato¹ 0
Inox² S

Temp. de Cor ◆
3000K 3
4000K 0
Tunable White³ T

Módulo ♣
SRT/MID 58
END 50

HIGH OUTPUT

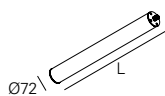

TUP - Difusor transparente

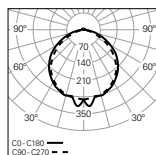

W	lm output	lm/W	Lmm	CÓDIGO*
26	3765	145	620	90487L060▼▲0♣♣
40	5648	141	900	90487L090▼▲0♣♣
51	7531	148	1180	90487L120▼▲0♣♣
63	9413	149	1460	90487L150▼▲0♣♣

TOP - Difusor opalino

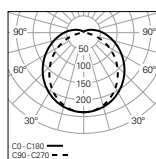

W	lm output	lm/W	Lmm	CÓDIGO*
26	3506	135	620	90486L060▼▲0♣♣
40	5259	131	900	90486L090▼▲0♣♣
51	7011	137	1180	90486L120▼▲0♣♣
63	8764	139	1460	90486L150▼▲0♣♣

MÓDULOS DISPONÍVEIS

◀ Módulo início / intermédio (SRT/MID) Módulo fim (END) ▶

LOW OUTPUT | HIGH OUTPUT

- Para completar o produto é necessário encomendar sistema de fixação em separado.
- Para versão suspensa é necessário encomendar suspensão e caixa de alimentação em separado.
- A luminária com sensor possui mais 215 mm de comprimento do que a medida standard.
- O número máximo de luminárias high output que se pode ligar em linha é 15. Com sensor o número máximo é 9.
- O número máximo de luminárias low output que se pode ligar em linha é 35. Com sensor o número máximo é 16.

¹ Topos injetados em policarbonato transparente. O produto é classe II.

² Topos em inox. O produto é classe I.

³ Apenas disponível nas versões DALI. Para os comprimentos de L620 e L900 mm, Tunable White é apenas aplicável para versões fim de linha (END).

02. Selecionar opções

OPÇÕES	Código*
SwitchDIM Tunable White	926600
• Permite controlar no máximo 20 luminárias, por cada SwitchDIM Tunable White.	
Sistema de fixação	
Abraçadeira inox A1 D70 (x2)	915403
Abraçadeira inox A2 D70 (x2)	915405
Abraçadeira inox D70 com fecho (x2)	915404
Suspensão	
S4 L1500 mm (x2)	910200
S4 L3000 mm (x2)	910204
S4 L6000 mm (x2)	910208
Caixa de alimentação ¹	
Saliente T24 D95	978600
Encastrar T5 D90	971300
Bucim para versões HF	
• Para todos os módulos início/intermédio (SRT/MID):	
Metálico M16 (x2)	925010
Metálico ventilado M16 (x2)	926710
• Para todos os módulos fim (END):	
Metálico M16 (x1)	925000
Metálico ventilado M16 (x1)	926700
Bucim para versões DALI	
• Para todos os módulos início/intermédio (SRT/MID):	
Metálico M20 (x2)	925011
Metálico ventilado M20 (x2)	926711
• Para todos os módulos fim (END):	
Metálico M20 (x1)	925001
Metálico ventilado M20 (x1)	926701
Sensor	
• Sob consulta.	
• Área de deteção: 100%. Tempo de espera: 5s. Limite de luz natural: desativo. Para outras programações consulte o manual do sensor.	



*Substitua os símbolos para completar o código

Cor

Branco W

Preto B



Detalhes do produto

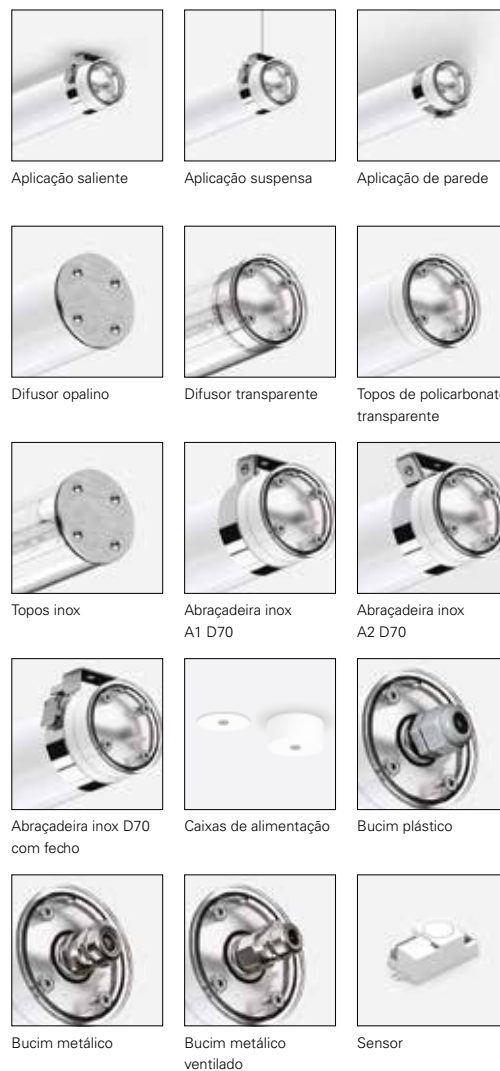

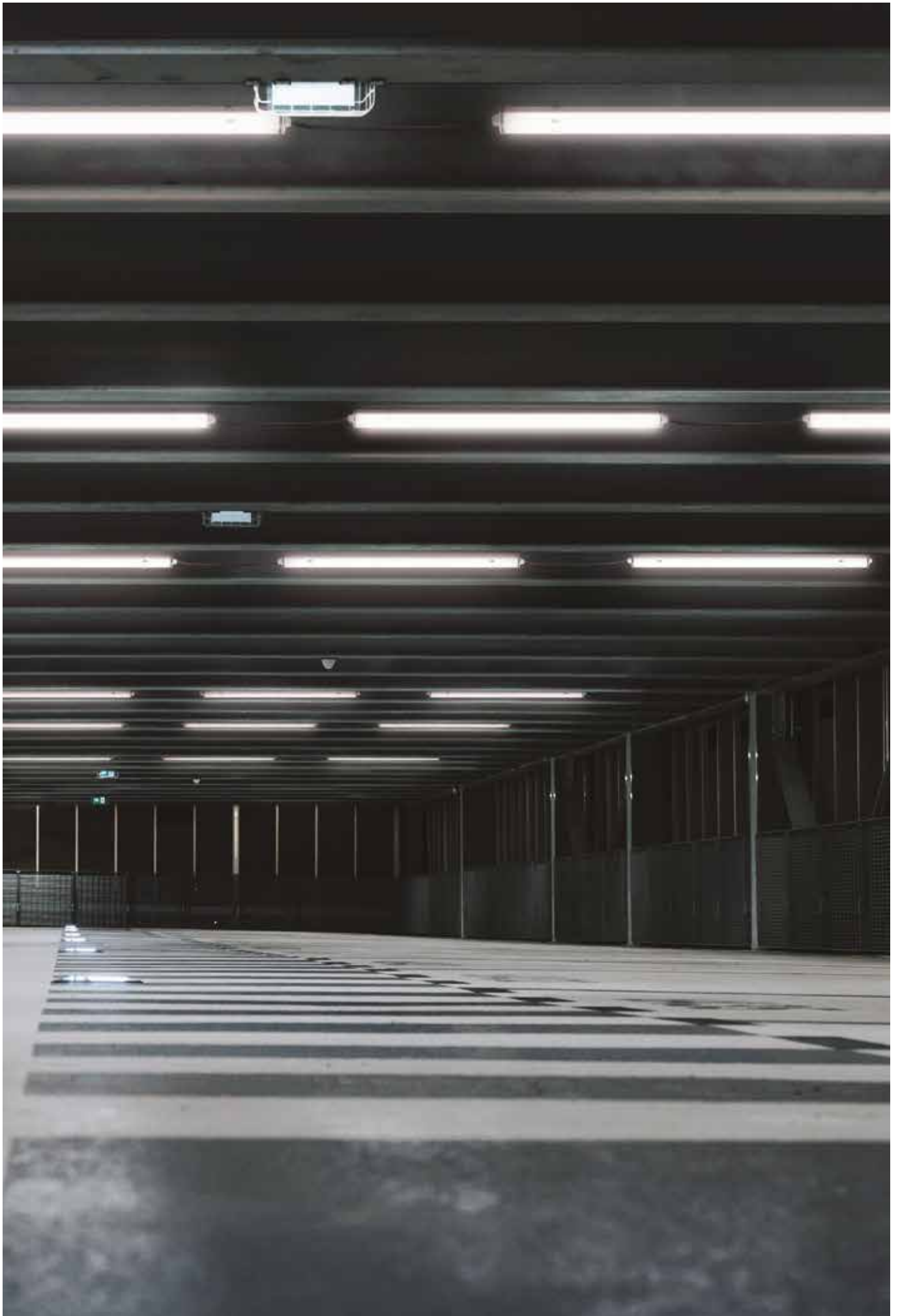

TTP 100



Características do produto

Corpo

Tubo de policarbonato



Acabamento

Interior revestido a epóxi-poliéster em branco mate



Sistema de fixação

Abraçadeiras não incluídas



Sistema ótico

TUP - Difusor transparente
TOP - Difusor opalino



Cablagem

Cabo H07RN-F de 1500 mm com buçim plástico incluído

Fonte de luz

LED, RG0, CRI>80, MacAdam Step ≤3

Vida útil LED

80.000h @ L90, B10, Ta 25°C

Fonte de alimentação

Driver LED 220-240V-50/60Hz incluído

01. Seleccionar versão

TTP 100

Topos em Alumínio

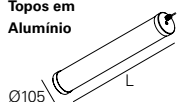

Topos em Inox

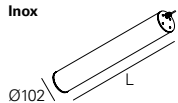

TUP - Difusor transparente

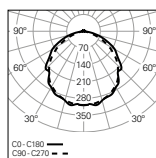

W	lm output	lm/W	Lmm	CÓDIGO*
23	3578	156	660	90481L060▼▲0◆00
33	5367	163	940	90481L090▼▲0◆00
45	7156	159	1220	90481L120▼▲0◆00
76	12556	165	1500	90496L150▼▲0◆00
95	15435	162	1500	90479L150▼▲0◆00

TOP - Difusor opalino

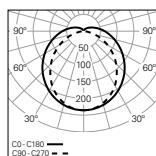

W	lm output	lm/W	Lmm	CÓDIGO*
23	3264	142	660	90480L060▼▲0◆00
33	4895	148	940	90480L090▼▲0◆00
45	6527	145	1220	90480L120▼▲0◆00
76	11388	150	1500	90495L150▼▲0◆00
95	13681	144	1500	90478L150▼▲0◆00

TTP 100

- Para completar o produto é necessário encomendar sistema de fixação em separado.
- Para versão suspensa é necessário encomendar suspensão e caixa de alimentação em separado.
- A luminária com sensor possui mais 105 mm de comprimento do que a medida standard.



*Substitua os símbolos para completar o código

Fonte de alimentação ▼

HF E

DALI H

Topos ▲

Alumínio 0

Inox S

Emergência ●

No EM 0

EM 3h (K3) ¹ 3

Temp. de Cor ◆

3000K 3





4000K 0

Tunable White ² T

¹ Kit de emergência de 3 horas com auto-test. Apenas disponível nas versões HF. Não disponível na versão 95W.

² Apenas disponível nas versões DALI sem kit de emergência (No EM).

02. Selecionar opções

OPÇÕES	Código*
SwitchDIM Tunable White	926600
<ul style="list-style-type: none"> • Permite controlar no máximo 20 luminárias, por cada SwitchDIM Tunable White. • Para versão de L1500 mm, apenas permite controlar no máximo 10 luminárias. 	
Sistema de fixação	
Abraçadeira inox A1 D100 (x2)	 915503
Abraçadeira inox A2 D100 (x2)	 915505
Abraçadeira inox D100 com fecho (x2)	 915504
Suspensão	
S4 L1500 mm (x2)	910200
Caixa de alimentação ¹	
Saliente T24 D95	 978600♣
Encastrar T5 D90	 971300♣
Bucim para versões HF	
Metálico M16 (x1)	925000
Metálico ventilado M16 (x1)	926700
Bucim para versões DALI	
Metálico M20 (x1)	925001
Metálico ventilado M20 (x1)	926701
Sensor	
<ul style="list-style-type: none"> • Sob consulta. • Área de deteção: 100%. Tempo de espera: 5s. Limite de luz natural: desativo. Para outras programações consulte o manual do sensor. 	
Sensor e kit de emergência (3 Horas)	
• Sob consulta.	



*Substitua os símbolos para completar o código

Cor ♣

Branco W

Preto B



Detalhes do produto



Aplicação saliente

Aplicação suspensão

Aplicação de parede

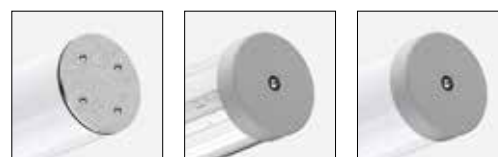

Difusor opalino

Difusor transparente

Topos de alumínio



Topos inox

Abraçadeira inox A1 D100

Abraçadeira inox A2 D100



Abraçadeira inox D100 com fecho

Caixas de alimentação

Bucim plástico



Bucim metálico

Bucim metálico ventilado

Sensor

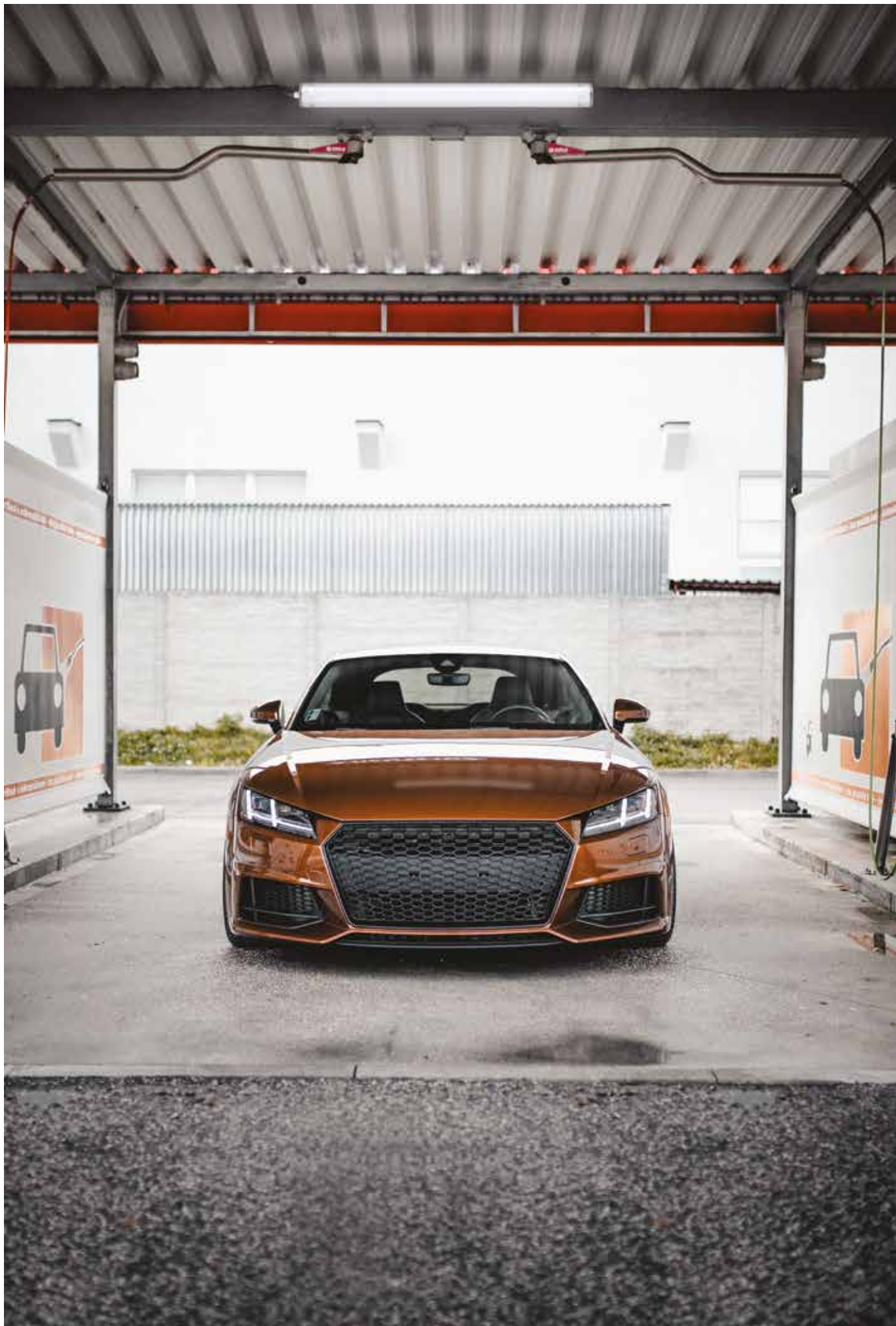

TTP 100 Line



Características do produto

Corpo

Tubo de policarbonato

**Acabamento**

Interior revestido a epóxi-poliéster em branco mate

230V/50Hz

Sistema de fixação

Abraçadeiras não incluídas

**Sistema ótico**

TUP - Difusor transparente
TOP - Difusor opalino

**Cablagem**

Bucim plástico e cablagem interna de linha contínua incluída
Cabo H07RN-F de 1500 mm não incluído

Fonte de luz

LED, RG0, CRI>80, MacAdam Step ≤3

Vida útil LED

80.000h @ L90, B10, Ta 25°C

Fonte de alimentação

Driver LED 220-240V-50/60Hz incluído

01. Selecionar versão



TTP 100 Line

Topos em Alumínio

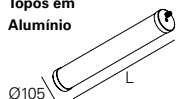

Topos em Inox

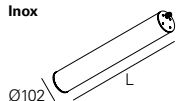

TUP - Difusor transparente

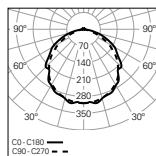

W	lm output	lm/W	Lmm	CÓDIGO*
23	3578	156	660	90493L060▼▲0♣♣
33	5367	163	940	90493L090▼▲0♣♣
45	7156	159	1220	90493L120▼▲0♣♣
76	12556	165	1500	90514L150▼▲0♣♣
95	15435	162	1500	90491L150▼▲0♣♣

TOP - Difusor opalino

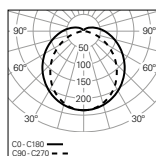

W	lm output	lm/W	Lmm	CÓDIGO*
23	3264	142	660	90492L060▼▲0♣♣
33	4895	148	940	90492L090▼▲0♣♣
45	6527	145	1220	90492L120▼▲0♣♣
76	11388	150	1500	90513L150▼▲0♣♣
95	13681	144	1500	90490L150▼▲0♣♣

*Substitua os símbolos para completar o código

Fonte de alimentação ▼

HF E

DALI H

Topos ▲

Alumínio 0

Inox S

Temp. de Cor ◆

3000K 3

4000K 0

Tunable White¹ T

Módulo ♣

SRT/MID 58

END 50

MÓDULOS DISPONÍVEIS

Módulo início / intermédio (SRT/MID)

 Módulo fim (END)

TTP 100 Line

- Para completar o produto é necessário encomendar sistema de fixação em separado.
- Para versão suspensa é necessário encomendar suspensão e caixa de alimentação em separado.
- A luminária com sensor possui mais 170 mm de comprimento do que a medida standard.
- O número máximo de luminárias que se pode ligar em linha é 31. Com sensor o número máximo é 8.
- O número máximo de luminárias que se pode ligar em linha para versão (L1500 mm - 95 W) é 15. Com sensor o número máximo é 4.

¹ Apenas disponível nas versões DALI. Para os comprimentos de L660 e L940 mm, Tunable White é apenas aplicável para versões fim de linha (END).

02. Selecionar opções

OPÇÕES	Código*
SwitchDIM Tunable White	926600
<ul style="list-style-type: none"> • Permite controlar no máximo 20 luminárias, por cada SwitchDIM Tunable White. • Para versão de L1500 mm, apenas permite controlar no máximo 10 luminárias. 	
Sistema de fixação	
Abraçadeira inox A1 D100 (x2)	915503
Abraçadeira inox A2 D100 (x2)	915505
Abraçadeira inox D100 com fecho (x2)	915504
Suspensão	
S4 L1500 mm (x2)	910200
S4 L3000 mm (x2)	910204
S4 L6000 mm (x2)	910208
Caixa de alimentação ¹	
Saliente T24 D95	978600
Encastrar T5 D90	971300
Bucim para versões HF	
• Para todos os módulos início/intermédio (SRT/MID):	
Metálico M16 (x2)	925010
Metálico ventilado M16 (x2)	926710
• Para todos os módulos fim (END):	
Metálico M16 (x1)	925000
Metálico ventilado M16 (x1)	926700
Bucim para versões DALI	
• Para todos os módulos início/intermédio (SRT/MID):	
Metálico M20 (x2)	925011
Metálico ventilado M20 (x2)	926711
• Para todos os módulos fim (END):	
Metálico M20 (x1)	925001
Metálico ventilado M20 (x1)	926701



*Substitua os símbolos para completar o código

Cor

<input type="checkbox"/> Branco	W
<input type="checkbox"/> Preto	B



Detalhes do produto



Aplicação saliente



Aplicação suspensa



Aplicação de parede



Difusor opalino

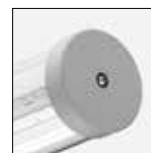

Difusor transparente



Topos de alumínio



Topos inox



Abraçadeira inox A1 D100



Abraçadeira inox A2 D100



Abraçadeira inox D100 com fecho



Caixas de alimentação



Bucim plástico



Bucim metálico



Bucim metálico ventilado



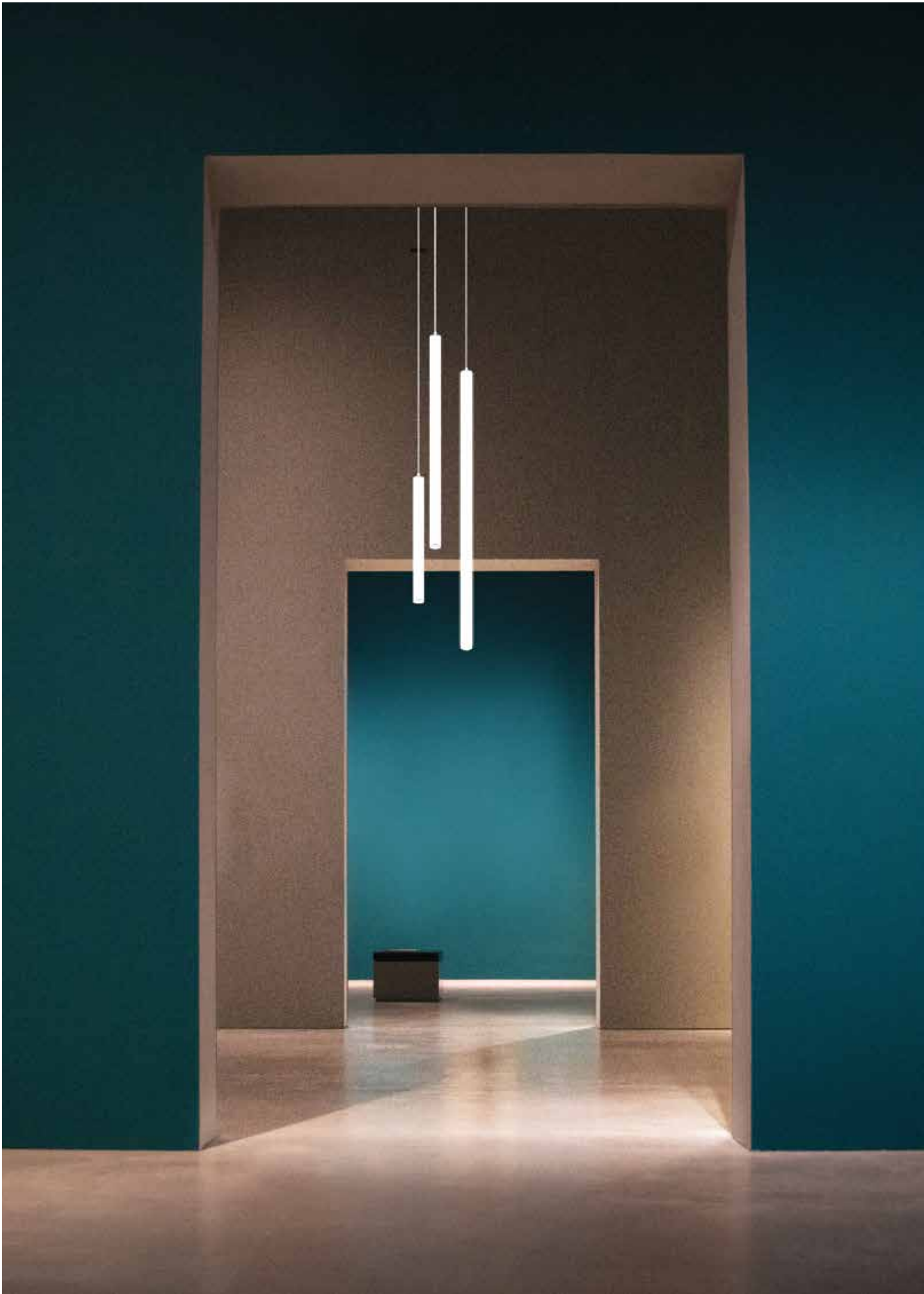

Luminárias
tubulares

TTP 50 360



TTP 50 360 HRZ
734

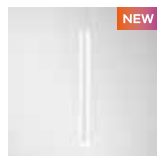

TTP 50 360 VRT
738



TTP 50 360 HRZ



Características do produto

Corpo

Tubo de policarbonato

Acabamento

Topos em alumínio revestidos
a epóxi-poliéster

Sistema ótico

TOP - Difusor opalino

Fonte de luz

LED, RG0, CRI>80, MacAdam Step ≤3

Vida útil LED

70.000h @ L80, B10, Ta 25°C

Fonte de alimentação

Não incluída



01. Seleccionar versão

TTP 50 360 HRZ

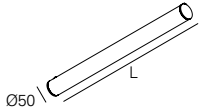

TOP - Difusor opalino

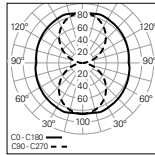

W	lm output	lm/W	Lmm	CÓDIGO*
10	912	91	572	90677L0600▲0◆00
18	1685	94	972	90677L0900▲0◆00
23	2275	99	1272	90677L1200▲0◆00
29	2916	101	1572	90677L1500▲0◆00



*Substitua os símbolos para completar o código

Cor	◆
□ Branco	W
■ Cinzento	G
■ Preto	B

Temp. de Cor	◆
3000K	3
4000K	0

TTP 50 360 HRZ

- Para completar o produto é necessário encomendar suspensão, cabo e caixa de alimentação em separado.

02. Seleccionar caixa de alimentação

Encastrar - T31 D90

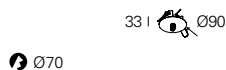

HF

L572, L972, L1272, L1572 **CÓDIGO***
972750♣

DALI

L572, L972, L1272, L1572 **CÓDIGO***
972752♣

Saliente - T36 L350W50

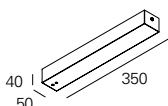

HF

L572, L972, L1272, L1572 **CÓDIGO***
972770♣

DALI

L572, L972, L1272, L1572 **CÓDIGO***
972772♣

CAIXA DE ALIMENTAÇÃO

- Fonte de alimentação incluída na caixa de alimentação.

03. Seleccionar opções

OPÇÕES

Código

Suspensão

- Para caixa encastrar T31 D90:

S4 L1500 mm (x2) 910200
S4 L3000 mm (x2) 910204
S4 L6000 mm (x2) 910208

- Para caixa saliente T36 L350W50:

S13 L1500 mm (x2) 913200
S13 L3000 mm (x2) 913201
S13 L6000 mm (x2) 913202

Cabo de alimentação transparente

L1500 mm - 2 x 0,75 mm² 942800
L3000 mm - 2 x 0,75 mm² 942801
L6000 mm - 2 x 0,75 mm² 942802



*Substitua os símbolos para completar o código

Cor

□ Branco

■ Preto

♣

W

B



Detalhes do produto



Suspensão

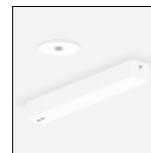

Caixas de alimentação



TTP 50 360 VRT



Características do produto

Corpo

Tubo de policarbonato

**Acabamento**

Topos em alumínio revestidos
a epóxi-poliéster

**Sistema ótico**

Policarbonato

**Fonte de luz**

LED, RG0, CRI>80, MacAdam Step ≤3

Vida útil LED

70.000h @ L80, B10, Ta 25°C

Fonte de alimentação

Não incluída

01. Seleccionar versão



TTP 50 360 VRT

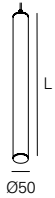

TOP - Difusor opalino

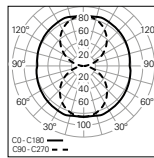

W	lm output	lm/W	Lmm	CÓDIGO*
10	912	91	570	90555L0600▲0♦00
18	1685	94	970	90555L0900▲0♦00
23	2275	99	1270	90555L1200▲0♦00
29	2916	101	1570	90555L1500▲0♦00
34	3370	99	1870	90555L1800▲0♦00
37	3744	101	2070	90555L2000▲0♦00

*Substitua os símbolos para completar o código

Cor	◆
□ Branco	W
■ Cinzento	G
■ Preto	B

Temp. de Cor	◆
3000K	3
4000K	0

TTP 50 360 VRT

- Para completar o produto é necessário encomendar cabo e caixa de alimentação em separado.

02. Seleccionar caixa de alimentação

Encastrar - T31 D90

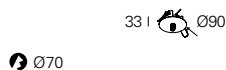

HF

	CÓDIGO*
L572, L972, L1272, L1572	972750♣
L1872, L2072	972751♣

DALI

	CÓDIGO*
L572, L972, L1272, L1572	972752♣
L1872, L207	972753♣

Saliente - T32 D80

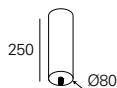

HF

	CÓDIGO*
L572, L972, L1272, L1572	972760♣
L1872, L2072	972761♣

DALI

	CÓDIGO*
L572, L972, L1272, L1572	972762♣
L1872, L2072	972763♣

CAIXA DE ALIMENTAÇÃO

- Fonte de alimentação incluída na caixa de alimentação.

03. Seleccionar opções

OPÇÕES

Cabo de alimentação transparente

	Código
L1500 mm - 2 x 0,75 mm ²	942800
L3000 mm - 2 x 0,75 mm ²	942801
L6000 mm - 2 x 0,75 mm ²	942802

Projetos à medida

- Sob consulta.



*Substitua os símbolos para completar o código

Cor	♣
<input type="checkbox"/> Branco	W
<input type="checkbox"/> Preto	B



Detalhes do produto



Caixas de alimentação

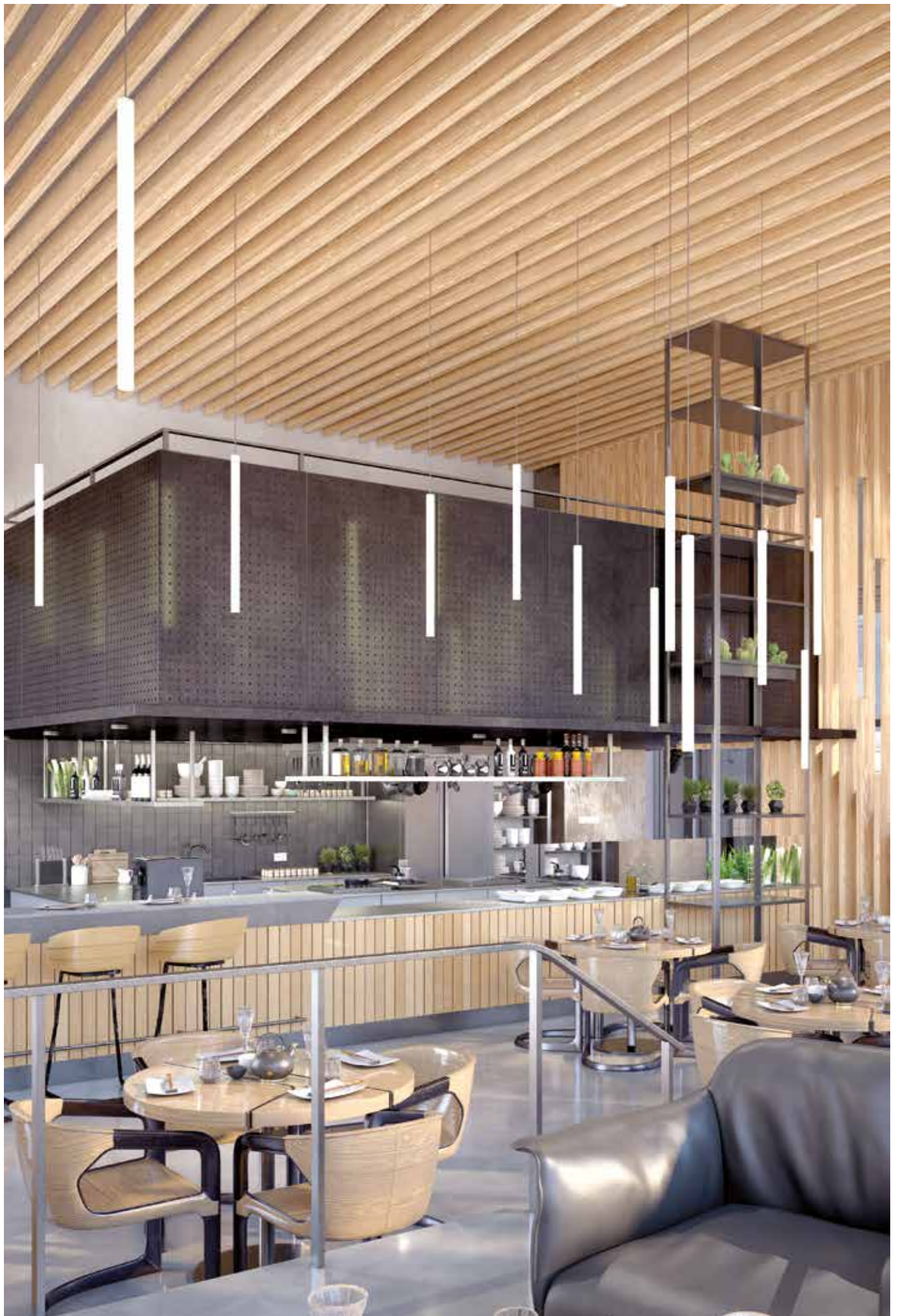



Luminárias
tubulares

TTP 70 COLOUR



TTP 70 Colour
746



Defina a sua cor

LUMINÁRIAS
TUBULARES

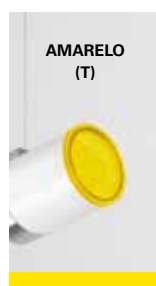
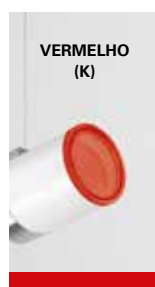
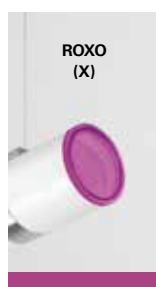
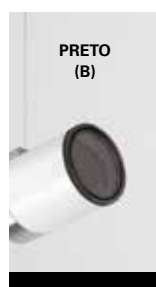
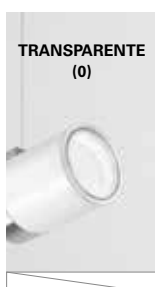

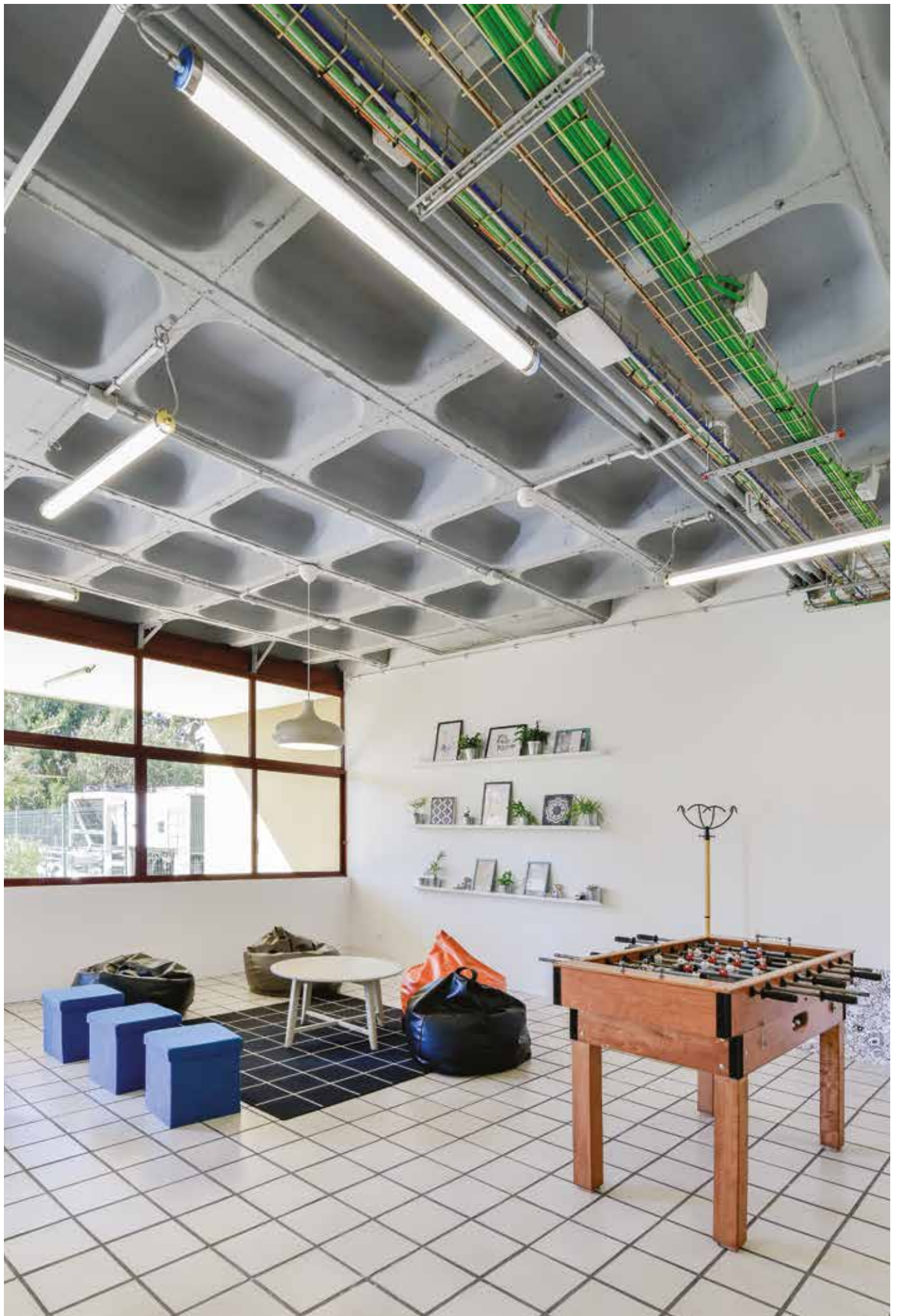

TTP 70 Colour

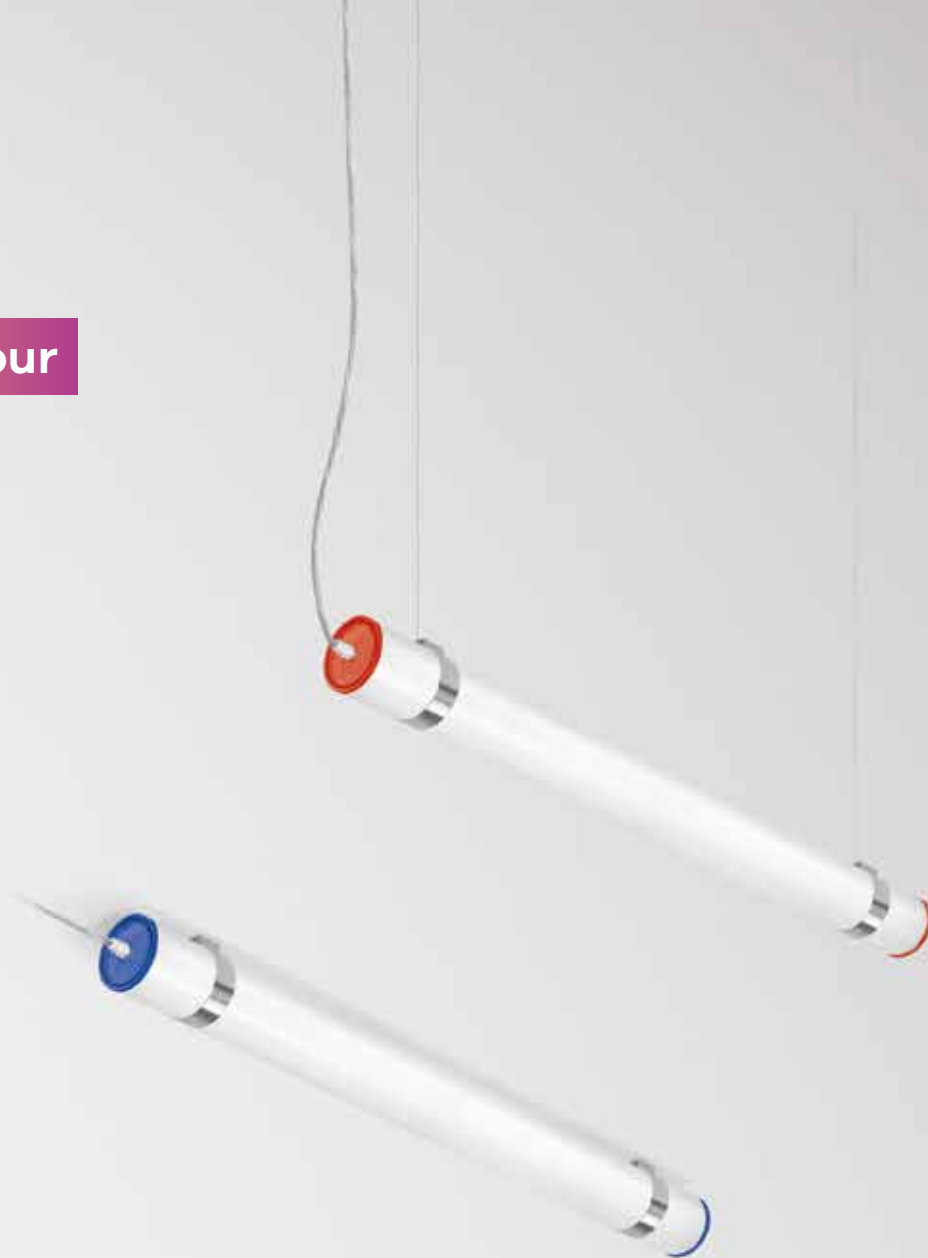

Características do produto

Corpo

Tubo de policarbonato e topos injetados em policarbonato



Acabamento

Interior revestido a epóxi-poliéster em branco mate

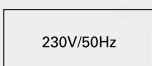

Sistema de fixação

Abraçadeiras não incluídas



Sistema ótico

TOP - Difusor opalino



Cablagem

Cabo transparente de 1500 mm com buçim plástico incluído

Fonte de luz

LED, RG0, CRI>80, MacAdam Step ≤3

Vida útil LED

80.000h @ L90, B10, Ta 25°C

Fonte de alimentação

Driver LED 220-240V-50/60Hz incluído

01. Selecionar versão

TTP 70 Colour

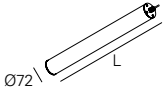

TOP - Difusor opalino

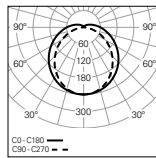

W	lm output	lm/W	Lmm	CÓDIGO*
12	1691	141	620	90551L060♥♣♦00
17	2536	149	900	90551L090♥♣♦00
21	3382	161	1180	90551L120♥♣♦00
26	4227	163	1460	90551L150♥♣♦00

TTP 70 Colour

- Para completar o produto é necessário encomendar sistema de fixação em separado.
- Para versão suspensa é necessário encomendar suspensão e caixa de alimentação em separado.



*Substitua os símbolos para completar o código

Fonte de alimentação ▼

HF E

DALI¹ H

Cor² ♣

☐ Transparente 0

■ Preto B

■ Roxo X

■ Vermelho K

■ Laranja Y

■ Amarelo T

■ Verde V

■ Azul U

Emergência ●

No EM 0

EM 3h (K3)³ 3

Temp. de Cor ◆

3000K 3

4000K 0

02. Selecionar opções

OPÇÕES

Sistema de fixação

Abraçadeira inox A1 D70 (x2) 915403

Suspensão

S4 L3000 mm (x2) 910204

S4 L6000 mm (x2) 910208

Cabo de alimentação transparente

L3000 mm - 3 x 0,75 mm² 940401

L3000 mm - 5 x 0,75 mm² 940501

L6000 mm - 3 x 0,75 mm² 940402

L6000 mm - 5 x 0,75 mm² 940507

Caixa de alimentação circular

Saliente T24 D95 978600♣

Encastrar T5 D90 971300♣

IP44

- Sob consulta.

¹ Nas versões DALI a luminária é equipada com buçim metálico e cabo transparente 5 x 1,5 mm².

² Cor dos topos.

³ Kit de emergência de 3 horas com auto-test. Apenas disponível nas versões HF.

LUMINÁRIAS ESTANQUES



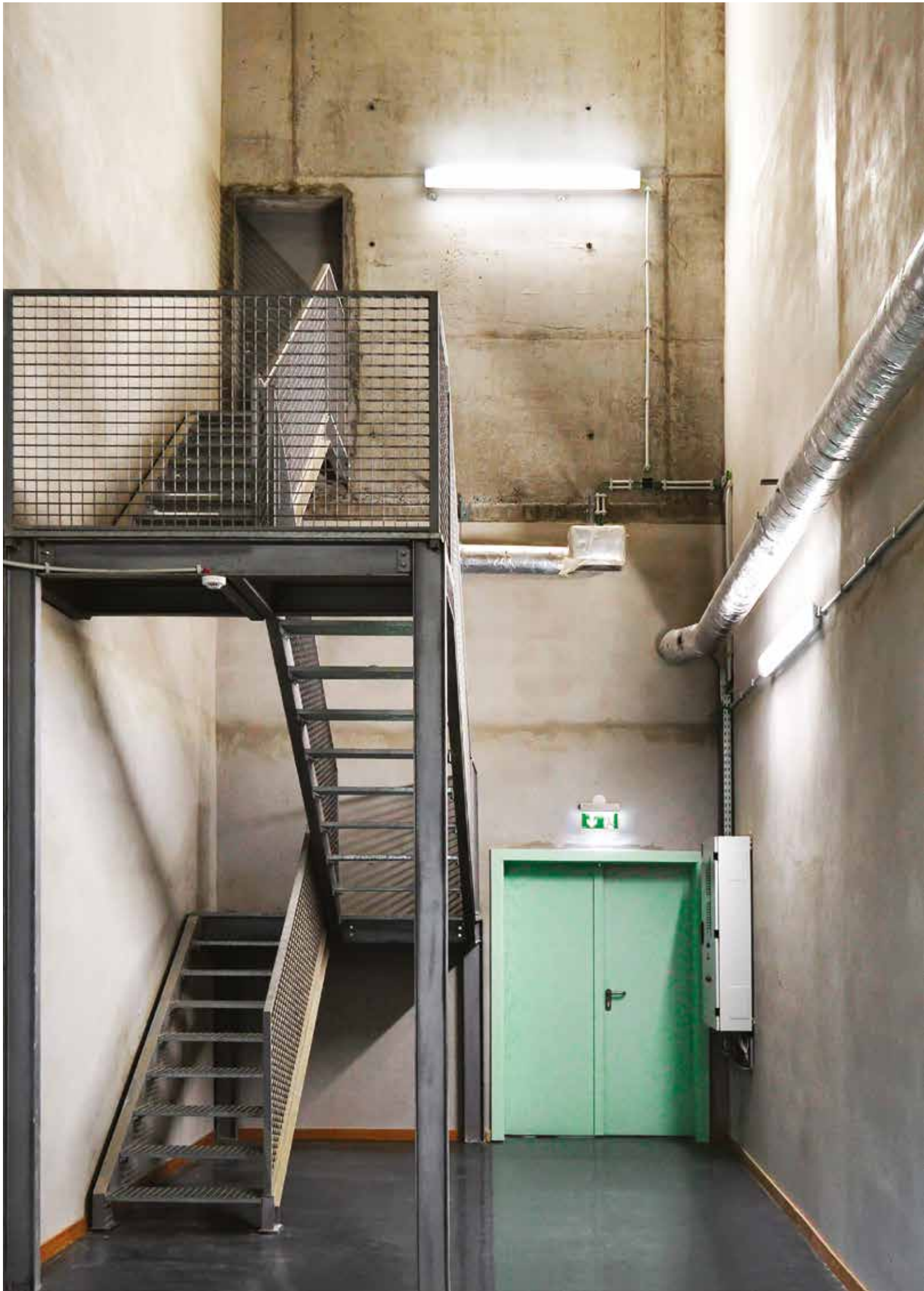

Luminárias
estanques

DORIS



DORIS
752



DORIS



Características do produto

Corpo

Policarbonato e junta de estanquicidade em poliuretano

Acabamento

Interior revestido a epóxi-poliéster em branco mate

Sistema de fixação

Clipes e suportes de fixação em aço inox

Sistema ótico

PC0 - Difusor em policarbonato opalino

Fonte de luz

LED 4000K, RG1, CRI>80, MacAdam Step ≤3

Vida útil LED

50.000h @ L90, B10, Ta 25°C

Fonte de alimentação

Driver LED 220-240V-50/60Hz incluído

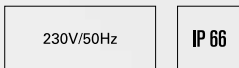

01. Selecionar versão

DORIS

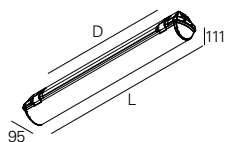

PC0 - Difusor em policarbonato opalino

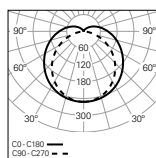

W	lm output	lm/W	Lmm	Dmm	CÓDIGO*
14	1960	140	662	350	90617L060♥0●000
27	3870	143	1272	700	90617L120♥0●000
38	5570	147	1272	700	90617L122♥0●000
33	4820	146	1572	940	90617L150♥0●000
45	6890	153	1572	940	90617L152♥0●000



*Substitua os símbolos para completar o código

Fonte de alimentação ▼
 HF E
 DALI H

Emergência ●
 No EM 0
 EM 3h (K3) ¹ 3



Detalhes do produto



Clipes em aço inox



Suportes de fixação em aço inox para montagem no teto



Suportes de fixação em aço inox para montagem suspensa



Corpo preparado para Loop In Loop Out



Difusor em policarbonato opalino

¹ Preparado para telecommando.

AMBIENTES INDUSTRIAIS E DESPORTIVOS





**Ambientes industriais
e desportivos**

CAB



CAB
758



CAB



Características do produto

Corpo

Chapa de aço

Aro

Alumínio

Acabamento

Revestido a epóxi-poliéster em branco mate

Cablagem

Pré-cablagem com cabo H05VV-F
de 1000 mm

Sistema ótico

Narrow - Ângulo de abertura estreito
Medium - Ângulo de abertura médio
Wide - Ângulo de abertura largo

Fonte de luz

LED 4000K, RG1, CRI>80, MacAdam Step ≤ 3

Vida útil LED

80.000h @ L80, B10, Ta 25°C

Fonte de alimentação

Driver LED 220-240V-50/60Hz incluído



230V/50Hz



01. Seleccionar versão



CAB

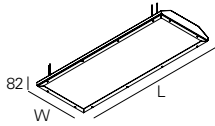

NARROW - Ângulo de abertura estreito

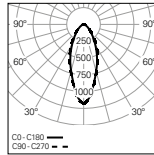

W	lm output	lm/W	LxWmm	CÓDIGO*
68	11206	165	676x365	90849L063▼VV●000
136	22411	165	1250x365	90849L123▼VV●000
182	29882	164	1250x470	90849L124▼VV●000

MEDIUM - Ângulo de abertura médio

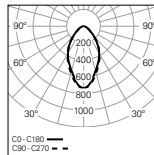

W	lm output	lm/W	LxWmm	CÓDIGO*
68	11206	165	676x365	90850L063▼VV●000
136	22411	165	1250x365	90850L123▼VV●000
182	29882	164	1250x470	90850L124▼VV●000

WIDE - Ângulo de abertura largo

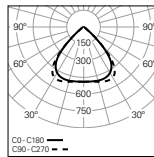

W	lm output	lm/W	LxWmm	CÓDIGO*
68	11327	167	676x365	90851L063▼VV●000
136	22655	167	1250x365	90851L123▼VV●000
182	30206	166	1250x470	90851L124▼VV●000

*Substitua os símbolos para completar o código

Fonte de alimentação	▼
HF	E
DALI	H



Emergência	●
No EM	0
EM 3h (K3) ¹	3

CAB

• Para completar o produto é necessário encomendar sistema de fixação em separado.

¹ Preparado para telecomando.

02. Selecionar opções

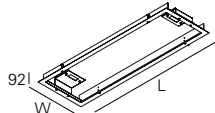
OPÇÕES	Código
Kit de conetores	
Kit de conetor IP68 3 pólos	966300
Kit de conetor IP68 5 pólos	966400
Kit saliente	
Fixações e parafusos incluídos (x2)	925701
Kit rotação	
Fixações e parafusos incluídos (x2)	925700
Suspensão	
Kit "pigtail" (x4)	911200
Kit olhal (x4)	911202
Kit para cabo de aço (x2)	911203
Kit encastrar	
676x365 mm	925702
1250x365 mm	925703
1250x470 mm	925704
<ul style="list-style-type: none">  725x412  1300x412  1300x518 	
	
Cabo de segurança em aço	
L1500 mm	955000
Sensor de luminosidade e presença	
• Sob consulta.	
Versão Low Output	
• Sob consulta.	



Detalhes do produto



Kit saliente



Kit rotação



Suspensões



Kit encastrar



LUMINÁRIAS ANTI-VANDALISMO





Luminárias
anti-vandalismo

ZLP



ZLP /E
766



ZLP
768



ZLP /C
772



ZLP /W
774



ZLP /E



Características do produto

Corpo

Chapa de aço

Acabamento

Revestido a epóxi-poliéster em branco mate

Sistema de fixação

Varão roscado M5 não incluído

Sistema ótico

DOZ - Difusor opalino

Fonte de luz

LED, RG1, CRI>80, MacAdam Step ≤3

Vida útil LED

72.000h @ L80, B10, Ta 25°C

Fonte de alimentação

Driver LED 220-240V-50/60Hz incluído

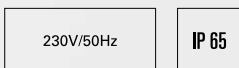

01. Selecionar versão

ZLP / E

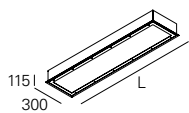

DOZ - Difusor opalino

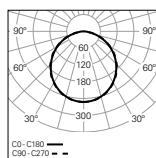

W	lm output	lm/W	Lmm	■	CÓDIGO*
38	4561	120	1225	1200x275	906J2222J♥4♣♦00
47	5701	121	1525	1500x275	906J2272J♥4♣♦00



*Substitua os símbolos para completar o código

Fonte de alimentação	▼
HF	F
DALI	E

Versão	♣
No EM	0
EM 3h (K3) ¹	3
Sensor	4
Night Light	N

Temp. de Cor	♦
3000K	3
4000K	0

02. Selecionar opções

OPÇÕES	Código
--------	--------

Bit especial anti-vândalo	926000
---------------------------	--------



Detalhes do produto



Bit anti-vândalo



Parafuso anti-vandalismo



Desenvolvida para resistir a impactos físicos extremos de até 170 Joules (IK17)

¹ Preparado para telecomando.



Características do produto

Corpo

Chapa de aço



Acabamento

Revestido a epóxi-poliéster em branco mate

230V/50Hz

Sistema de fixação

Varão roscado M5 não incluído



Sistema ótico

DOZ - Difusor opalino

Fonte de luz

LED, RG1, CRI>80, MacAdam Step ≤ 3



Vida útil LED

72.000h @ L80, B10, Ta 25°C

Fonte de alimentação

Driver LED 220-240V-50/60Hz incluído

01. Selecionar versão

ZLP

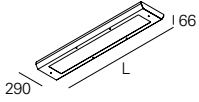

DOZ - Difusor opalino

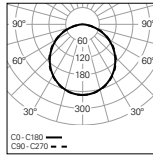

W	lm output	lm/W	Lmm	CÓDIGO*
38	4561	120	1350	906H2222J♥4♣♦00
47	5701	121	1650	906H2272J♥4♣♦00



*Substitua os símbolos para completar o código

Fonte de alimentação	
HF	F
DALI	E

Versão	
No EM	0
EM 3h (K3) ¹	3
Sensor	4
Night Light	N

Temp. de Cor	
3000K	3
4000K	0

02. Selecionar opções

OPÇÕES	Código
Bit especial anti-vândalo	926000



Detalhes do produto



Bit anti-vândalo



Parafuso anti-vandalismo



Desenvolvida para resistir a impactos físicos extremos de até 170 Joules (IK17)

¹ Preparado para telecomando.





ZLP /C

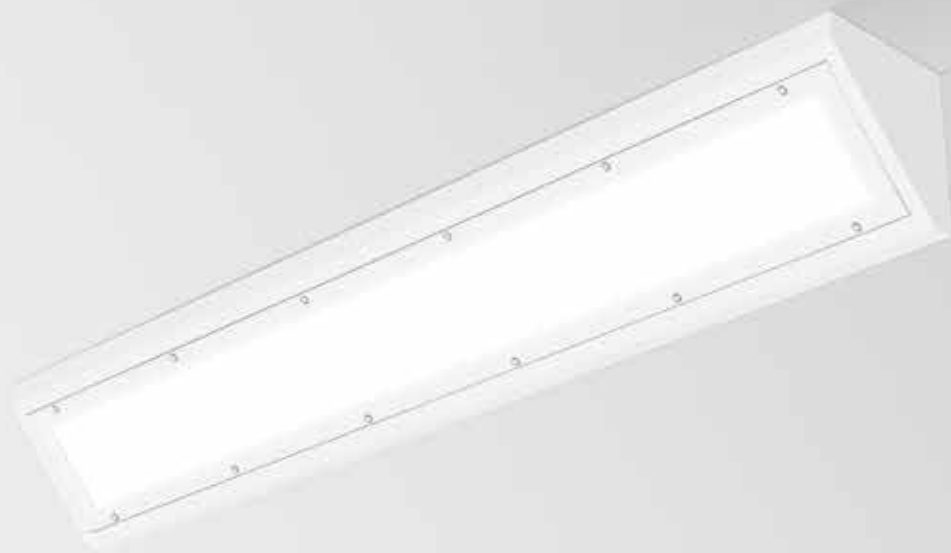

Características do produto

Corpo

Chapa de aço



Acabamento

Revestido a epóxi-poliéster em branco mate

230V/50Hz

Sistema de fixação

Varão roscado M5 não incluído



Sistema ótico

DOZ - Difusor opalino

Fonte de luz

LED, RG1, CRI>80, MacAdam Step ≤3

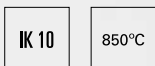

Vida útil LED

72.000h @ L80, B10, Ta 25°C

Fonte de alimentação

Driver LED 220-240V-50/60Hz incluído

01. Selecionar versão

ZLP / C

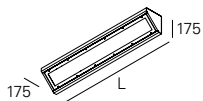

DOZ - Difusor opalino

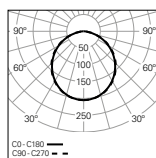

W	lm output	lm/W	Lmm	CÓDIGO*
38	3662	96	1215	906I2222J♥4♣♦00
47	4577	97	1515	906I2272J♥4♣♦00



*Substitua os símbolos para completar o código

Fonte de alimentação	
HF	F
DALI	E

Versão	
No EM	0
EM 3h (K3) ¹	3
Sensor	4
Night Light	N

Temp. de Cor	
3000K	3
4000K	0

02. Selecionar opções

OPÇÕES	Código
Bit especial anti-vândalo	926000



Detalhes do produto



Bit anti-vândalo



Parafuso anti-vandalismo



Desenvolvida para resistir a impactos físicos extremos de até 170 Joules (IK17)

¹ Preparado para telecomando.

ZLP /W



Características do produto

Corpo

Chapa de aço



Acabamento

Revestido a epóxi-poliéster em branco mate

230V/50Hz

Sistema de fixação

Varão roscado M5 não incluído



Sistema ótico

DOZ - Difusor opalino

Fonte de luz

LED, RG1, CRI>80, MacAdam Step ≤3



Vida útil LED

80.000h @ L90, B10, Ta 25°C

Fonte de alimentação

Driver LED 220-240V-50/60Hz incluído

01. Selecionar versão



ZLP /W

*Substitua os símbolos para completar o código



DOZ - Difusor opalino

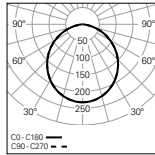

W	lm output	lm/W	Lmm	CÓDIGO*
4	307	77	200	90832L020♥W0♦00
6	614	102	200	90831L020♥W0♦00
6	613	102	300	90832L030♥W0♦00
11	1226	111	300	90831L030♥W0♦00

Fonte de alimentação	
HF	E
DALI	H

Temp. de Cor	
3000K	3
4000K	0

02. Selecionar opções



Detalhes do produto

OPÇÕES	Código
Bit especial anti-vândalo	926000



Bit anti-vândalo



Parafuso anti-vandalismo



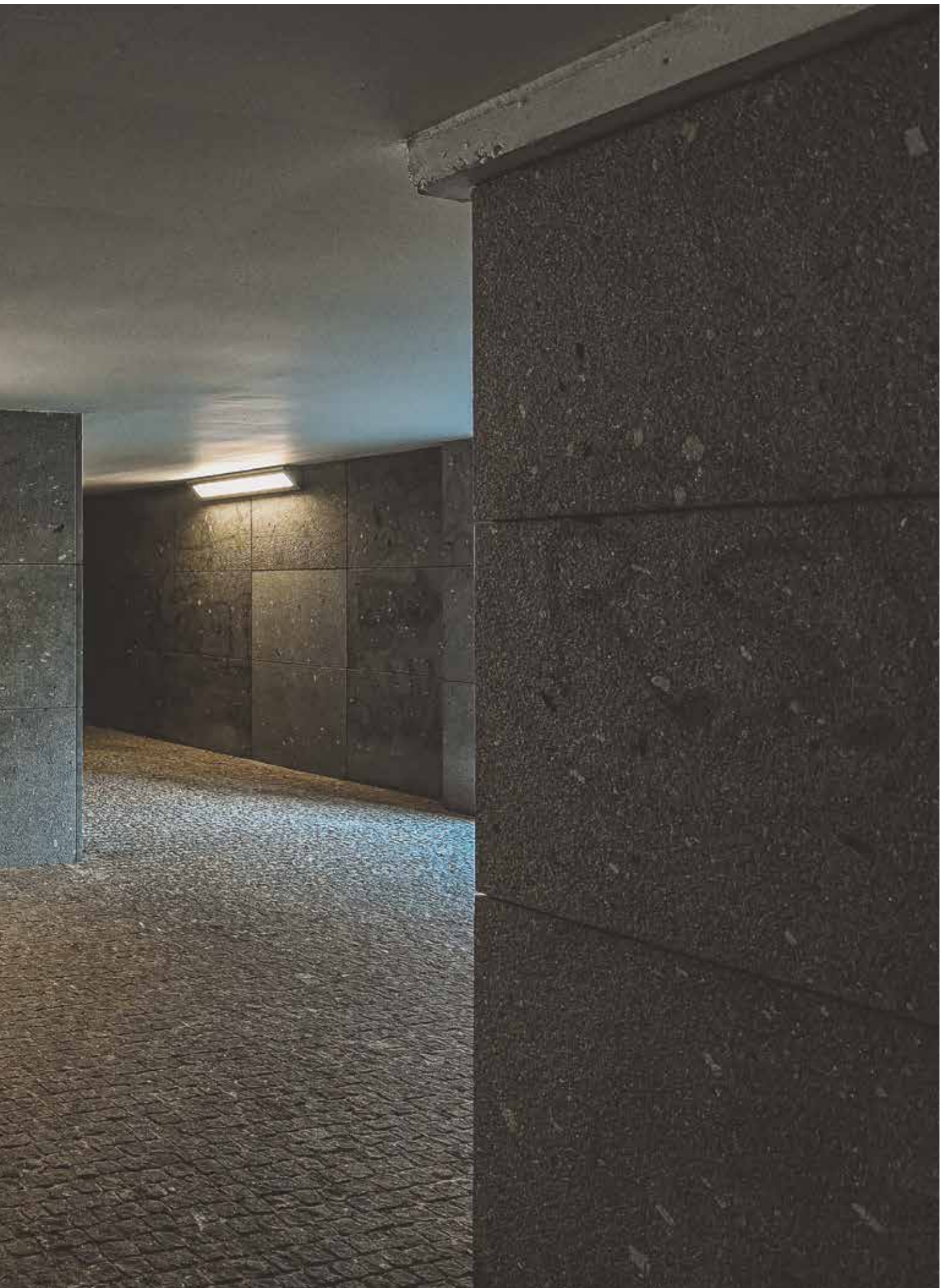

RÉGUAS E SISTEMAS DE CALHA





Réguas e sistemas
de calha

PAS



PAS
782



PAS Line
784



PAS



Características do produto

Corpo

Perfil de alumínio extrudido

Acabamento

Revestido a epóxi-poliéster

Sistema ótico

Lente

Fonte de luz

LED 4000K, RG1, CRI>80, MacAdam Step ≤3

Vida útil LED

80.000h @ L80, B10, Ta 25°C

Fonte de alimentação

Driver LED 220-240V-50/60Hz incluído



230V/50Hz



IP 20

650°C

01. Selecionar versão

PAS

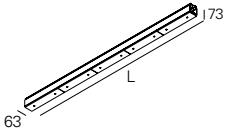

Lente simétrica | Ângulo de abertura de 90°

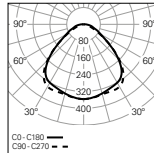

W	lm output	lm/W	Lmm	CÓDIGO*
50	8050	161	1436	90770L005♥♣♠000
59	9338	158	1436	90771L005♥♣♠000
100	16100	161	2871	90770L010♥♣♠000
118	18676	158	2871	90771L010♥♣♠000

Lente assimétrica

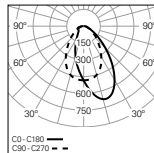

W	lm output	lm/W	Lmm	CÓDIGO*
50	7963	159	1436	90772L005♥♣♠000
59	9237	157	1436	90773L005♥♣♠000
100	15925	159	2871	90772L010♥♣♠000
118	18473	157	2871	90773L010♥♣♠000



*Substitua os símbolos para completar o código

Fonte de alimentação ▼
 HF E
 DALI H

Cor ▲
 Branco W
 Cinzento G

Emergência ●
 No EM 0
 EM 3h (K3) ¹ 3

PAS

• Nos comprimentos de L2871 mm, apenas metade da luminária é equipada com kit de emergência.

02. Selecionar opções



Detalhes do produto

OPÇÕES Código

Cabo de alimentação

• Sob consulta.

Suspensão

Suporte de fixação para varão roscado (x2)	910102
Suporte de fixação + gancho "pigtail" (x2)	910101
Suporte de fixação + cabo de aço ajustável (x2)	910103
Suporte de fixação + gancho de fixação suspensa (x2)	910100



Suspensões

¹ Preparado para telecomando.

PAS Line



Características do produto

Corpo

Perfil de alumínio extrudido

Acabamento

Revestido a epóxi-poliéster

Sistema ótico

Lente

Fonte de luz

LED 4000K, RG1, CRI>80, MacAdam Step ≤3

Vida útil LED

80.000h @ L80, B10, Ta 25°C

Fonte de alimentação

Driver LED 220-240V-50/60Hz incluído



230V/50Hz



IP 20

650°C

01. Selecionar versão

PAS Line

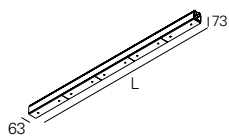

Lente simétrica | Ângulo de abertura de 90°

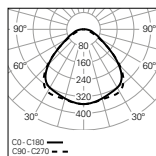

W	lm output	lm/W	Lmm	CÓDIGO*
50	8050	161	1435	90774L005▼▲●000
59	9338	158	1435	90775L005▼▲●000
100	16100	161	2870	90774L010▼▲●000
118	18676	158	2870	90775L010▼▲●000

Lente assimétrica

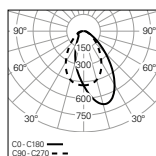

W	lm output	lm/W	Lmm	CÓDIGO*
50	7963	159	1435	90776L005▼▲●000
59	9237	157	1435	90777L005▼▲●000
100	15925	159	2870	90776L010▼▲●000
118	18473	157	2870	90777L010▼▲●000



*Substitua os símbolos para completar o código

Fonte de alimentação ▼

HF	E
DALI	H
HF TRIFASICO	R
DALI TRIFASICO	S

Cor ▲

<input type="checkbox"/> Branco	W
<input type="checkbox"/> Cinzento	G

Emergência ●

No EM	0
EM 3h (K3) ¹	3

PAS Line

- Para versão suspensa é necessário encomendar suspensão em separado.
- Para completar a linha é necessário encomendar start kit, cablagem de linha contínua e kit de união em separado.
- Nos comprimentos de L2870 mm, apenas metade da luminária é equipada com kit de emergência.
- As dimensões não incluem start kit. Adicione 1 mm ao comprimento para completar a linha.
- O comprimento máximo da linha com um único ponto de alimentação é 30000 mm.

¹ Preparado para telecomando.

02. Selecionar opções

OPÇÕES	Código*
Start kit - topo início/fim	
Branco	921501
Cinzento	921500
• Dois topos incluídos.	
Cablagem linha contínua	
3 x 1,5 mm ²	945660
5 x 1,5 mm ²	945760
7 x 1,5 mm ²	946060
9 x 1,5 mm ²	948660
11 x 1,5 mm ²	948860
Kit de união	
• União galvanizada.	930800
Cabo de alimentação	
• Sob consulta.	
Suspensão	
Suporte de fixação para varão roscado (x2)	910102
Suporte de fixação + gancho "pigtail" (x2)	910101
Suporte de fixação + cabo de aço ajustável (x2)	910103
Suporte de fixação + gancho de fixação suspensa (x2)	910100
Módulo cego	
L1500 mm	992600♣
L3000 mm	992601♣
Projetos à medida	
• Sob consulta.	



*Substitua os símbolos para completar o código

Cor	♣
<input type="checkbox"/> Branco	W
<input type="checkbox"/> Cinzento	G



Detalhes do produto



Suspensões



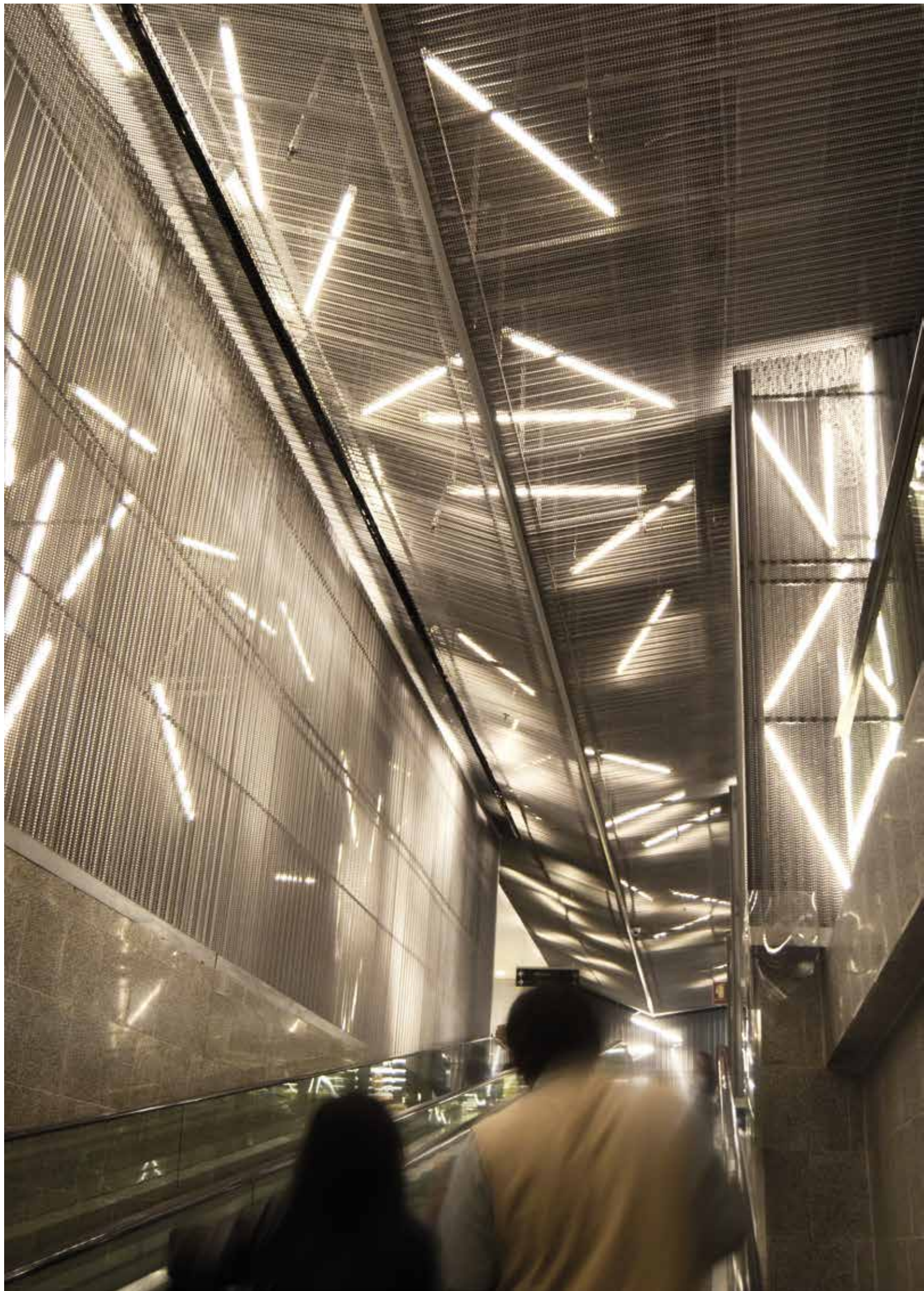

Réguas e sistemas
de calha

TRN



TRN
790





Características do produto

Corpo

Chapa de aço



Acabamento

Revestido a epóxi-poliéster em branco mate

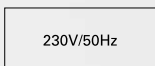

Sistema ótico

DAZ - Difusor opalino



Fonte de luz

LED, RG1, CRI>80, MacAdam Step ≤3

Vida útil LED

80.000h @ L90, B10, Ta 25°C



Fonte de alimentação

Driver LED 220-240V-50/60Hz incluído

01. Selecionar versão

TRN

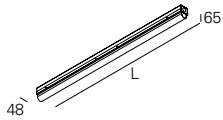

DAZ - Difusor opalino

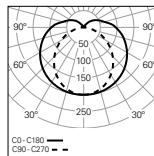

W	lm output	lm/W	Lmm	CÓDIGO*
12	1747	146	590	90834L060▼W0♣♣
23	3494	146	1150	90834L120▼W0♣♣
29	4368	151	1430	90834L150▼W0♣♣



*Substitua os símbolos para completar o código

Fonte de alimentação	▼
HF	E
DALI	H

Emergência	●
No EM	0
EM 3h (K3) ¹	3

Temp. de Cor	◆
3000K	3
4000K	0

Conetor	♣
Sem conetor	00
M3M ²	M3
M5M ³	M5
M3MFC ⁴	C3
M5MFC ⁵	C5



Detalhes do produto



Conetor



LED

¹ Preparado para telecomando.

² Conetor macho mini Wieland de 3 pólos GST15i3.

³ Conetor macho mini Wieland de 5 pólos GST15i5.

⁴ Conetor macho mini Wieland de 3 pólos GST15i3 + L1000 mm de cabo com conetor fêmea de 3 pólos GST15i3.

⁵ Conetor macho mini Wieland de 5 pólos GST15i5 + L1000 mm de cabo com conetor fêmea de 5 pólos GST15i5 DIM.

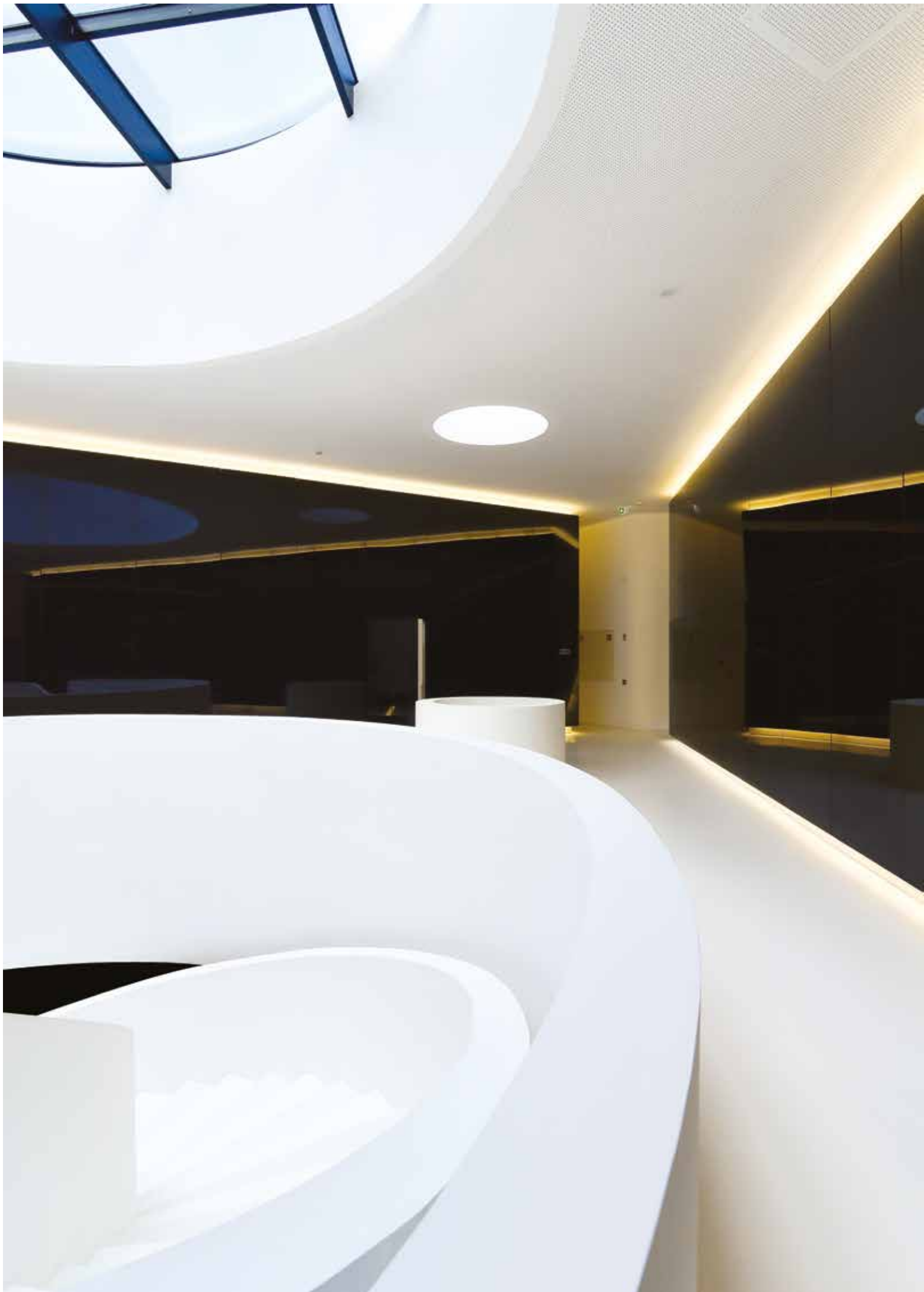

Réguas e sistemas
de calha

AVL



AVL
794





Características do produto

Corpo

Chapa de aço



Acabamento

Revestido a epóxi-poliéster em branco mate

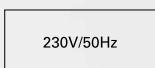

Sistema ótico

DPT - Difusor transparente



Fonte de luz

LED, RG1, CRI>80, MacAdam Step ≤3

Vida útil LED

80.000h @ L80, B10, Ta 25°C



Fonte de alimentação

Driver LED 220-240V-50/60Hz incluído

01. Selecionar versão

AVL

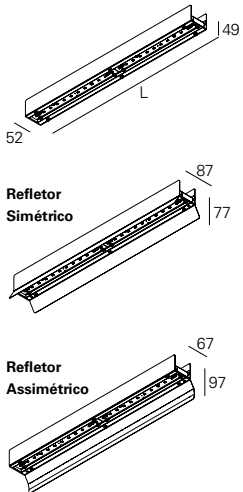

DPT - Difusor transparente

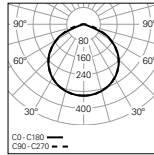

W	lm output	lm/W	Lmm	CÓDIGO*
13	1786	137	561	90826L060♥VV0♦00
18	2678	149	841	90826L090♥VV0♦00
24	3571	149	1121	90826L120♥VV♦♦00
29	4464	154	1401	90826L150♥VV♦♦00



*Substitua os símbolos para completar o código

Fonte de alimentação	▼
HF	E
DALI	H

Emergência	●
No EM	0
EM 3h (K3) ¹	3

Temp. de Cor	◆
3000K	3
4000K	0

02. Selecionar opções

OPÇÕES	Código
Refletor simétrico	
L561 mm	980600
L841 mm	980601
L1121 mm	980602
L1401 mm	980603
Refletor assimétrico	
L561 mm	980500
L841 mm	980501
L1121 mm	980502
L1401 mm	980503
Cablagem linha contínua	
3 x 1,5 mm ²	945650
5 x 1,5 mm ²	945750
7 x 1,5 mm ²	946050
9 x 1,5 mm ²	948650
Kit de fixação	
• Fixação para parafusos M4x8 DIN7985.	926100



Detalhes do produto



Refletor simétrico



Refletor assimétrico



Kit de fixação

¹ Preparado para telecomando.

SISTEMA DE CALHA



Composição de elementos estruturais

1. Alimentador terminal

- 1.1 Esquerdo
- 1.2 Direito

2. Calha

3. Alimentador em L

- 3.1 Interior
- 3.2 Exterior

4. Alimentador em T

- 4.1 Exterior direito
- 4.2 Exterior esquerdo
- 4.3 Interior esquerdo
- 4.4 Interior direito

5. Alimentador central

6. Alimentador em X

7. Conetor

- 7.1 Conetor reto
- 7.2 Conetor ajustável
- 7.3 Conetor flexível

8. Topo

Esquema elétrico

A

1-fase, 3-circuito 230 V AC,
16 A, 3.7 kVA



N-condutor I = máx. 16 A

B

3-fase, 3-circuito 230/400 V AC,
16 A, 3 x 3.7 kVA

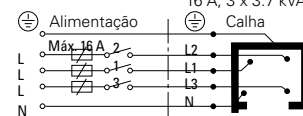

L1+L2+L3: I = máx. 16 A

C

3-fase, 3-fase 230/400 V AC,
16 A, 11.1 kVA

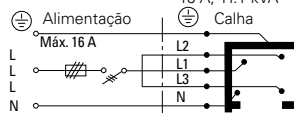

N-condutor I = máx. 16 A

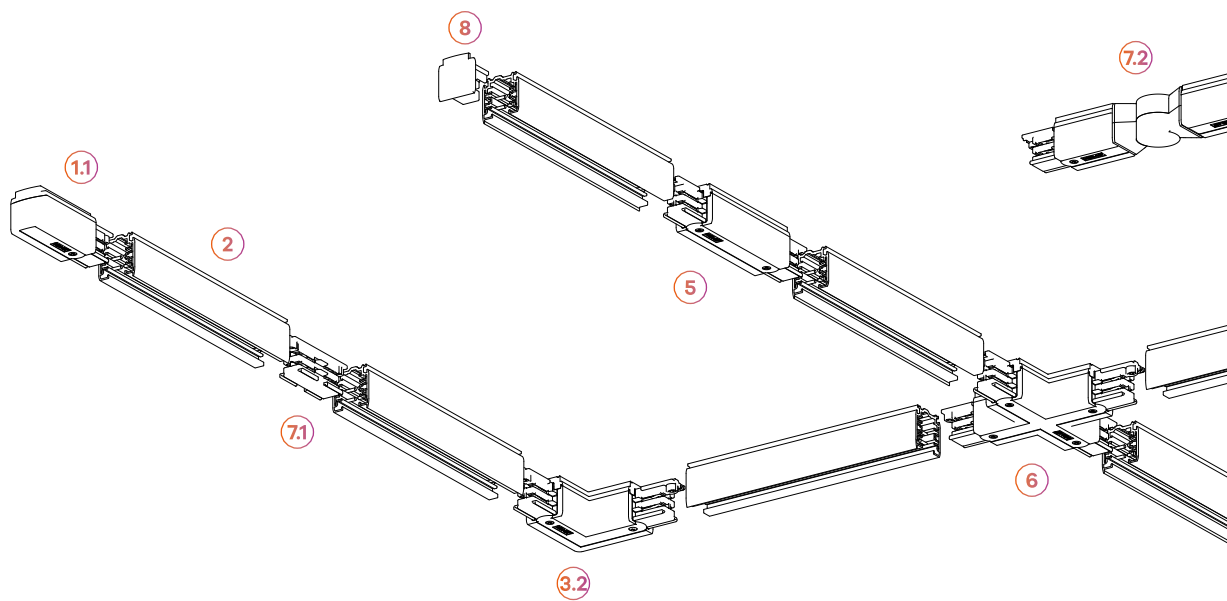

Como estruturar uma linha

(Vista de cima)

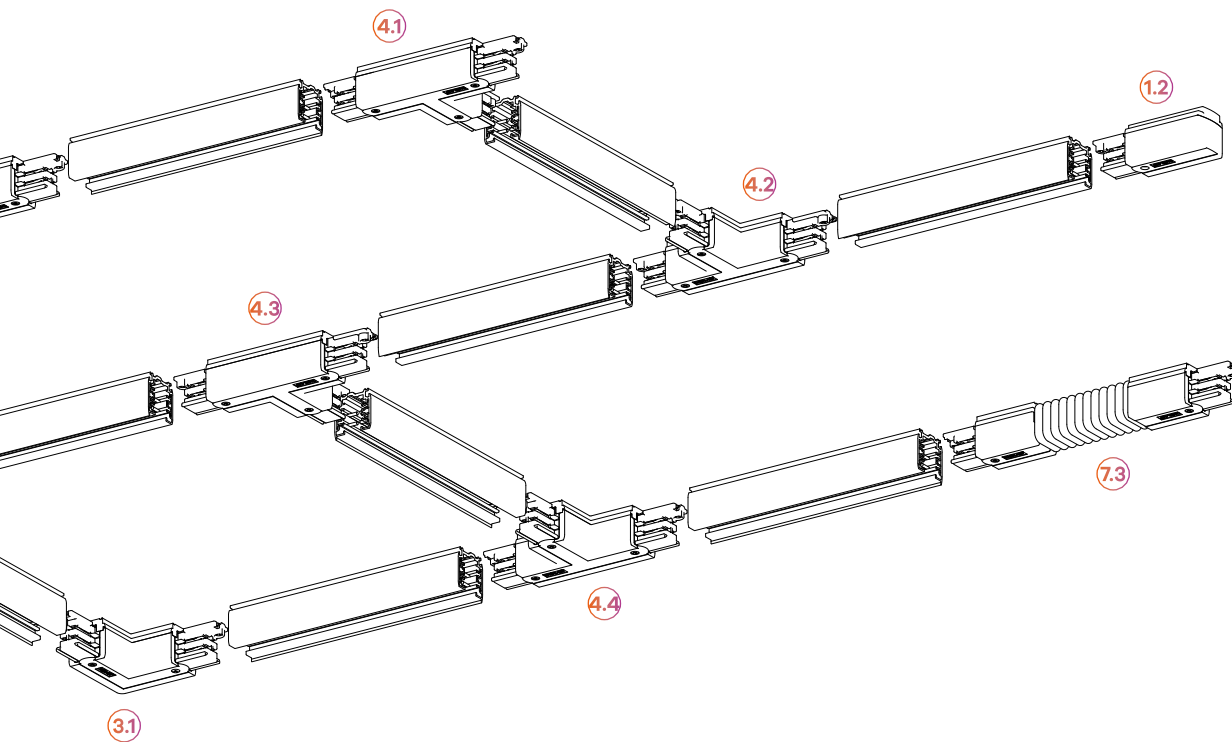
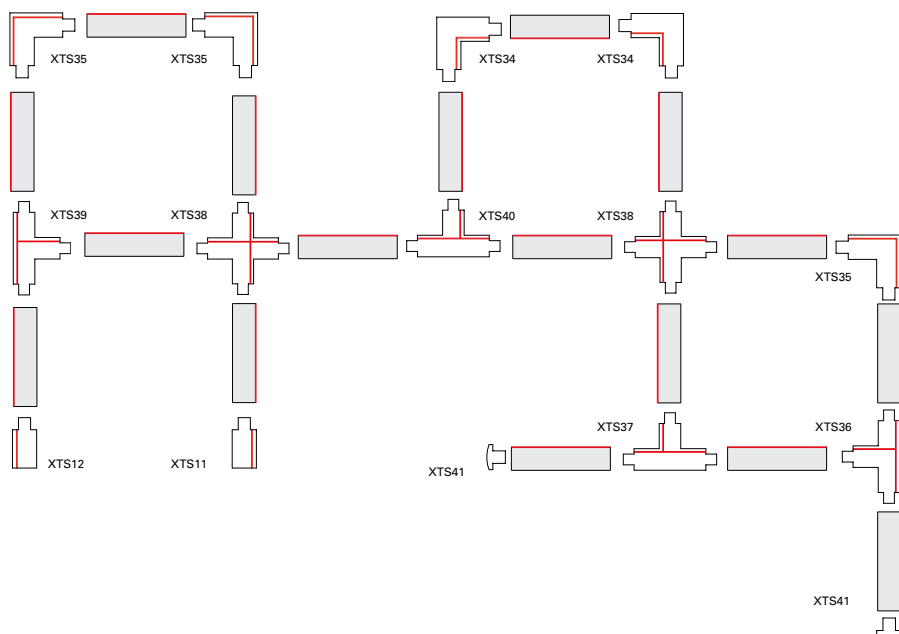

01. Seleccionar sistema de calha

TRACK SYSTEM - SISTEMA DE CALHA

Encastrar

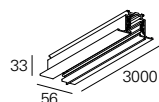

HF
DALI

CÓDIGO*
XTSF4300-▲
XTSCF6300-▲

Saliente

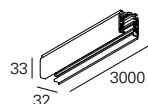

HF
DALI

CÓDIGO*
XTS4300-▲
XTSC6300-▲



*Substitua os símbolos para completar o código

Cor	▲
■ Alumínio	1
■ Preto	2
□ Branco	3

02. Seleccionar alimentadores

ALIMENTADOR

Terminal - Direito

HF
DALI

CÓDIGO*
XTS11-▲
XTSC611-▲

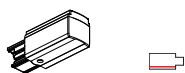

T - Exterior direito

HF
DALI

CÓDIGO*
XTS36-▲
XTSC636-▲

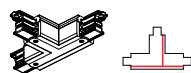

L - Interior

HF
DALI

CÓDIGO*
XTS34-▲
XTSC634-▲

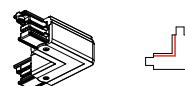

Terminal - Esquerdo

HF
DALI

CÓDIGO*
XTS12-▲
XTSC612-▲



T - Interior esquerdo

HF
DALI

CÓDIGO*
XTS37-▲
XTSC637-▲

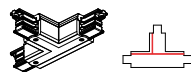

L - Exterior

HF
DALI

CÓDIGO*
XTS35-▲
XTSC635-▲

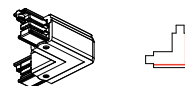

T - Exterior esquerdo

HF
DALI

CÓDIGO*
XTS39-▲
XTSC639-▲

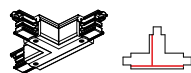

Central

HF
DALI

CÓDIGO*
XTS14-▲
XTSC614-▲

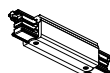

T - Interior direito

HF
DALI

CÓDIGO*
XTS40-▲
XTSC640-▲

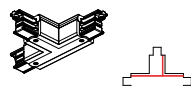

X

HF
DALI



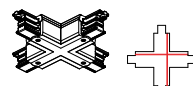







CÓDIGO*
XTS38-▲
XTSC638-▲



*Substitua os símbolos para completar o código

Cor	▲
■ Alumínio	1
■ Preto	2
□ Branco	3

03. Selecionar opções

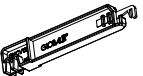
OPÇÕES		Código*
Fixação		
SKB 10		SKB10-♣
SKB 12		SKB12-♣
Conector		
Conector reto HF		XTS21-♣
Conector reto DALI		XTSC621-♣
Conector flexível HF		XTS23-♣
Conector flexível DALI		XTSC623-♣
Conector ajustável HF		XTS24-♣
Topo HF/DALI		
		XTS41-♣
Tampa para encastrar		
XTSF 10		XTSF610-♣
XTSF 30		XTSF30-♣
Ferramenta		
		XTSV12



*Substitua os símbolos para completar o código

Cor	♣
■ Aluminio	1
■ Preto	2
□ Branco	3



Detalhes do produto



Calha de encastrar



Calha saliente

INFORMAÇÃO TÉCNICA



Legenda

	Produto fabricado em conformidade com a Diretiva de Compatibilidade Eletromagnética 2004/108/CE e com a Diretiva para Equipamento de Baixa Tensão 2006/95/CE.	HF	Driver - Sem regulação de fluxo.	CRI	Colour Render Index - Índice de reprodução de cor é a capacidade de uma fonte de luz reproduzir cores de forma fiel em comparação com uma fonte de luz ideal ou natural (Daylight CRI = 100). Um índice de reprodução de cor entre 90 e 100 é considerado muito bom, e entre 80 e 90 é bom.
	Classe I - Aparelhos de iluminação com um terminal terra para proteção, ao qual estão conectadas todas as partes metálicas, de forma a que as partes condutoras acessíveis não possam ficar ativas em caso de defeito do isolamento principal.	DALI	Digital Addressable Lighting Interface - Driver DALI para regulação de fluxo.	Lxx) B(xx)	Degradação do fluxo luminoso - O fluxo luminoso de um módulo LED diminui ao longo do seu tempo de vida. Esta degradação é caracterizada pelo valor L. A vida útil de um módulo LED que integra uma luminária está relacionado com a depreciação do fluxo luminoso a uma determinada temperatura ambiente. L70, L80 ou L90 indica a quantidade de lumens (em % relativamente ao fluxo luminoso inicial) que permanecerá após o fim de vida útil dos módulos LED, ou seja, L80 significa que o módulo LED apresentará 80% do seu fluxo luminoso inicial. É importante ter em atenção que o valor de L está relacionado com o número de horas de funcionamento que, conseqüentemente, irá definir o tempo de vida útil do módulo LED. O valor B define a quantidade de módulos LED que estão abaixo do especificado no valor L, ou seja, L70B10 significa que 10% dos módulos LED estão abaixo de 70% do fluxo luminoso inicial e respetivamente 90% estará acima de 70% do valor inicial.
	Classe II - Aparelhos de iluminação em que as partes metálicas não estão acessíveis. Normalmente são aparelhos com duplo isolamento, ou com todas as partes metálicas isoladas. Não necessita de terminal terra para proteção.	TouchDIM	Touch DIM oferece a oportunidade de controlar a iluminação sem nenhum dispositivo de controle adicional. Touch DIM não faz parte do protocolo standard DALI. Touch DIM permite o controle através de botões (em vez de interruptores).	EM 3h (K3)	Indica a disponibilidade para Kit de emergência de 3 horas. Válido apenas para as versões driver HF (ON/OFF). Versões DALI disponíveis sob consulta.
	Classe III - Aparelhos de iluminação que funcionam com tensão de segurança reduzida. Não necessita de terminal terra para proteção.	SwitchDIM	A função SwitchDIM permite, através de um impulso no interruptor a regulação da intensidade de luz. Um breve toque (<0,6 s) liga ou desliga a luminária. Quando pressionado por aprox. 2 segundos, o sistema começa a contar os impulsos, fazendo a luminária aumentar ou diminuir a intensidade de luz.	UGR	Unified Glare Rating - Traduz o índice de ofuscamento. Os valores apresentados neste catálogo são indicativos e estão de acordo com os planos de reflexão 70/50/20.
IP XX	Índice de proteção contra a penetração de objetos sólidos e líquidos.	W	Watt - Unidade de potência.		Dimensão da área de corte para produtos de encastrar em milímetros (mm).
IP XX/YY	IP XX/YY Luminária com IPxx no corpo e IPyy na parte visível (aro).	lm	Lumen - Unidade de medida de fluxo luminoso utilizada para descrever a quantidade de luz emitida por uma fonte de luz.	K	Temperatura de cor em Kelvin (K).
IK XX	Índice de proteção mecânica contra impactos mecânicos.	lm/W	Eficácia luminosa - Indica a eficiência com a qual a energia eléctrica consumida é transformada em luz. Os valores indicados referem-se às medições efetuadas no lado primário: Output power (230 V, 50 Hz).		Ângulo do feixe de luz - Indica os ângulos de feixe de luz em graus (°) (valor aproximado) tendo como base o plano C0-C180.
XXX°C	Resistência ao fio incandescente, em graus Celsius (°C).				
230V/50Hz	Tensão e Frequência de alimentação da luminária.				
	Luminária que não pode ser coberta com material isolante térmico.				
	Produto com 5 anos de garantia (verificar nas Condições Gerais de Venda).				
	Rotação horizontal máxima e / ou inclinação vertical da luminária, em graus (°).				

Índice de proteção

ÍNDICE DE PROTEÇÃO - IP _ _

Código representado como "IPxx", em que "xx" são os dígitos que fornecem informação relativa ao índice de proteção do aparelho contra objetos sólidos (1º dígito) e líquidos (2º dígito), definidos pela norma EN 60 529, pelas diretivas UTEC 20 010 e DIN 40 050.

1º Dígito

(Proteção contra poeira e objetos sólidos)

0	Sem proteção.
1	Protegido contra corpos sólidos > 50mm.
2	Protegido contra corpos sólidos > 12mm.
3	Protegido contra corpos sólidos > 2,5mm.
4	Protegido contra corpos sólidos > 1mm.
5	Protegido contra pó.
6	Totalmente protegido contra o pó.

2º Dígito

(Proteção contra humidade e líquidos)

0	Sem proteção.
1	Protegido contra queda vertical de gotas de água.
2	Protegido contra quedas de água > 15° na vertical.
3	Protegido contra quedas de água > 60° na vertical.
4	Protegido contra lançamento de água.
5	Protegido contra jatos de água.
6	Protegido contra jatos de água (alta pressão).
7	Protegido contra imersão temporária.
8	Protegido contra efeitos prolongados de imersão em baixa pressão.

ÍNDICE DE PROTEÇÃO MECÂNICA - IK _ _

Este código é representado como "IKxx", em que "xx" são os dígitos que fornecem informação relativa ao índice de proteção mecânica do aparelho contra impactos mecânicos, definidos pela norma EN 50 102.

Os dígitos "xx" representam o valor de energia de impacto, medida em Joule, em conformidade com a escala seguinte:

00	Sem proteção.
01	Protegido contra impacto de 0,15J
02	Protegido contra impacto de 0,2J
03	Protegido contra impacto de 0,35J
04	Protegido contra impacto de 0,5J
05	Protegido contra impacto de 0,7J
06	Protegido contra impacto de 1J
07	Protegido contra impacto de 2J
08	Protegido contra impacto de 5J
09	Protegido contra impacto de 10J
10	Protegido contra impacto de 20J

Tabela de resistência aos agentes químicos

AGENTES QUÍMICOS	PC	PMMA	PES	AL
Acetato de etilo	-	-	-	+
Acetona	-	-	-	+
Ácido acético 10%	+	+	+	+
Ácido carbônico	-	-	+	+
Ácido cítrico 20%	+	+	+	+
Ácido clorídrico 5%	+	+	~	-
Ácido nítrico 20%	~	~	-	-
Ácido nítrico a mais de 20%	-	-	-	-
Ácido sulfúrico até 50%	+	+	-	-
Ácido sulfúrico concentrado	-	-	-	-
Água oxigenada até 30%	+	+	-	+
Água oxigenada a mais de 30%	~	~	-	+
Álcool concentrado	-	-	~	~
Álcool etílico 30%	+	~	+	~
Amónia a 25%	-	+	-	+
Anilina	-	-	-	+
Benzeno	-	-	-	+
Cimento	+	+	+	+
Clima marítimo	+	+	+	~
Cloro líquido (vapores)	-	-	-	-
Clorofenol	-	-	-	+
Clorofórmio	-	-	-	+
Cloro de cálcio	+	+	+	+
Cloro de sódio	+	+	+	~
Diclorometano	-	-	-	~
Éter	-	-	~	+
Fenol	-	-	-	~
Gasóleo - nafta	~	+	+	+
Hidróxido de sódio	+	+	+	-
Iodo	-	-	+	~
Metanol	-	-	+	+
Nitrato de cálcio	+	+	+	+
Nitrato de potássio	+	+	+	+
Óleos e gorduras alimentares	-	+	+	+
Óleo mineral	+	+	+	+
Oxigénio	+	+	+	+
Ozono	+	+	+	+
Petróleo	-	+	+	+
Soda cáustica 5%	-	+	-	-
Sulfato de alumínio	+	+	+	+
Sulfato de cobre	+	+	+	-
Sulfato de magnésio	+	+	+	+
Sulfato de sódio	+	+	+	+
Sulfato de zinco	+	+	+	~
Tetracloro de carbono	-	-	-	+
Tolueno	-	-	-	+
Tricloroetileno	-	-	-	+

LEGENDA

PC (Policarbonato), PMMA (Acrílico), PES (Poliéster), AL (Alumínio)
+ Resistente, ~ Parcialmente resistente, - Não resistente

NOTA

Os dados da tabela são referentes à temperatura de 22°C, considerando que o grau de saturação das substâncias químicas e a temperatura ambiente condicionam a velocidade e intensidade das reações, dependendo do tipo e composição das substâncias envolvidas.

6	6th ELEMENT /C	48	F	FESAL	422	R	ROFY 60	172	
	6th ELEMENT /W	54		FESAL IP	426		ROFY 60 D/I	176	
	6th ELEMENT *	36		FESAL Sq	424		ROFY 60 Sq	198	
	6th ELEMENT	40		FESAL Sq IP	428		ROFY 60 Sq D/I	202	
	6th ELEMENT FIX	44		FOCUS 2	360		ROFY 85 /E	180	
A	AURA	452	G	GLAM /W	268		ROFY 85	182	
	AVL	794		GLAM /WE	264		ROFY 85 D/I	186	
	AVT	656		GLAM	248		ROFY 85 IP /C	192	
B	bLED	642		GLAM 48V	274		ROFY 85 IP /E	190	
C	CAB	758	H	HOLI Sq /AS Max	404	S	SENSE	416	
	CLOUD	634		HOLI Sq /C	408		SLIM	456	
	CONCEPT D 35	122		HOLI Sq /C Max	410	T	TALEA	678	
	CONCEPT D 35 D/I	126		HOLI Sq /C Mini	406		TALEA Glare /C	686	
	CONCEPT O 35 /E	104		HOLI Sq /T	390		TALEA Glare	690	
	CONCEPT O 35	106		HOLI Sq /T Max	392		TALEA HRZ	678	
	CONCEPT O 35 D/I	110		HOLI Sq /T Mini	388		TALEA Line	682	
	CONCEPT O 65	146		HOLI Sq	398		TEI	638	
	CONCEPT O 65 D/I	150		HOLI Sq Max	400		THE	658	
	CONCEPT S 35 /E	90		HOLI Sq Mini	396		THS	660	
	CONCEPT S 35	94	L	LNE	646		TRN	790	
	CONCEPT S 35 D/I	98		LNE IP	662		TTP 100	724	
	CONCEPT S 65	138		LNS	650		TTP 100 Line	728	
	CONCEPT S 65 D/I	142		LNS IP	664		TTP 50 360 HRZ	734	
	CONCEPT Sq 35	114	N	NOAH /D	68		TTP 50 360 VRT	738	
	CONCEPT Sq 35 D/I	118		NOAH	62		TTP 50	708	
	CORA /C	628	O	OREO /C	214		TTP 50 Line	712	
	CORA /E	620		OREO In	216		TTP 70	716	
	CORA	624		OREO Linea Down	232		TTP 70 Colour	746	
D	DORIS	752		OREO Linea Up	236		TTP 70 Line	720	
	DYNA /C	442	P	OREO Out	220		V	VEGA /E	366
	DYNA	438		OREO V In	224		VEGA	372	
	DYNA IP	444		OREO V Out	228		VEGA IP /E	378	
	DYNA MINI /C	434	R	PAS	782		VEGA IP	382	
	DYNA MINI	430		PAS Line	784		VEGA Sq /E	368	
	DYNA MINI Sq	432	R	REBA 50 /E	522		VEGA Sq IP /E	380	
	DYNA Sq	440		REBA 50 /E bOPTICS	474		VEGA Sq	374	
	DYNA Sq IP	446		REBA 50 /E bOPTICS Line	478		VISA	460	
E	ELI /C	342		REBA 50 /E Line	526	Z	ZLP /C	772	
	ELI /E 1	328		REBA 50 /T	512		ZLP /E	766	
	ELI /E 2	330		REBA 50 /T Line	516		ZLP /W	774	
	ELI /W	348		REBA 50 /W	560		ZLP	768	
	ELI /W D/I	352		REBA 50 /W Line	564				
	ELI	338		REBA 50	532				
	ELI 50 /C	300		REBA 50 bOPTICS	484				
	ELI 50 /E 1	284		REBA 50 bOPTICS Line	488				
	ELI 50 /E 2	286		REBA 50 D/I	550				
	ELI 50 /W	304		REBA 50 D/I Line	554				
	ELI 50 /W D/I	308		REBA 50 HEXA	546				
	ELI 50	294		REBA 50 Line	536				
	ELI 50 Spot /C	318		REBA 65 /E	584				
	ELI 50 Spot /E 1	314		REBA 65 /E Line	588				
	ELI 50 Spot /E 2	316		REBA 65 /T	574				
	ELI 50 Spot Track	320		REBA 65 /T Line	578				
	ELI 50 Sq /C	302		REBA 65	594				
	ELI 50 Sq /E 1	288		REBA 65 D/I	604				
	ELI 50 Sq /E 2	290		REBA 65 D/I Line	608				
	ELI 50 Sq /W	306		REBA 65 Line	598				
	ELI 50 Sq /W D/I	310		ROFY 60 /T	166				
	ELI 50 Sq	296		ROFY 60 /T D/I	168				
	ELI Sq /C	344							
	ELI Sq /E 1	332							
	ELI Sq /E 2	334							
	ELI Sq /W	350							
	ELI Sq /W D/I	354							
	ELI Sq	340							

INDELAGUE GROUP

HEADQUARTERS

INDELAGUE - INDÚSTRIA ELÉTRICA
DE ÁGUEDA S.A.
Rua da Mina 465 | Covão
Zona industrial EN1 Norte
3750-792 Trofa
ÁGUEDA | PORTUGAL
T. +351 234 612 310
indelague@indelague.pt

SPAIN

INDELAGUE ESPAÑA, S.L.
Avenida del Ejército, nº 8 - 1º C
C.P. 15006 | A CORUÑA | ESPAÑA
comercial@indelague.com

PUBLICAÇÃO

Indelague SA

EDITOR

Indelague SA

CONCEITO E DESIGN

Indelague SA

EDIÇÃO

Julho 2024

Made in Portugal

CATÁLOGO INDELAGUE - VOLUME 15

Versão Portuguesa
Impresso em Portugal

Todos os dados contidos neste catálogo não constituem nenhum compromisso por parte da empresa que lhe reserva o direito de efetuar as modificações que considere oportunas, sem aviso prévio. É interdita a reprodução, ainda que parcial, deste catálogo.
Dados elétricos/óticos = $\pm 10\%$.

