

GLAM

Range

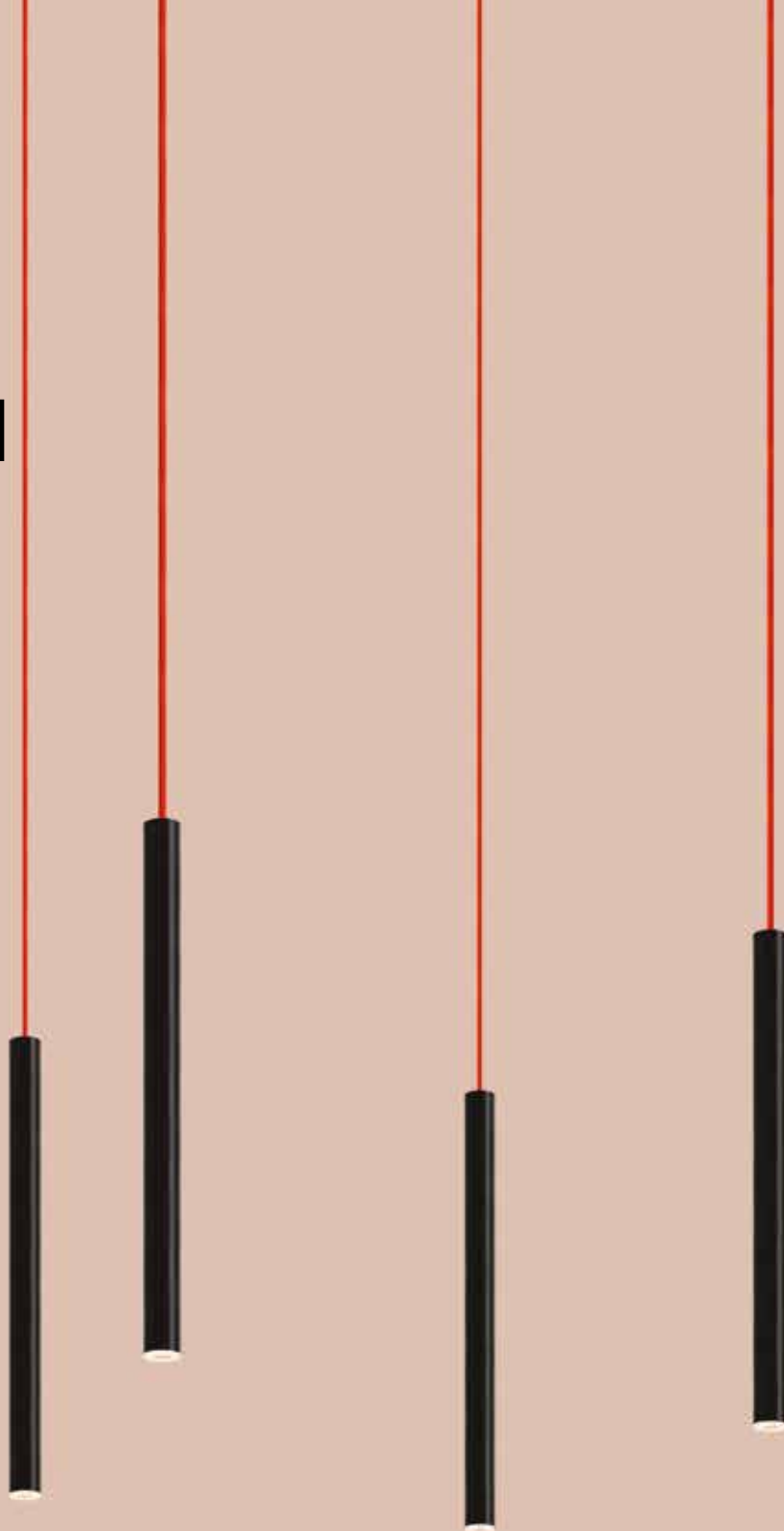

INDELAGUE GROUP

INDELAGUE ROXO lighting

Overview

ARCHITECTURAL
LIGHTING

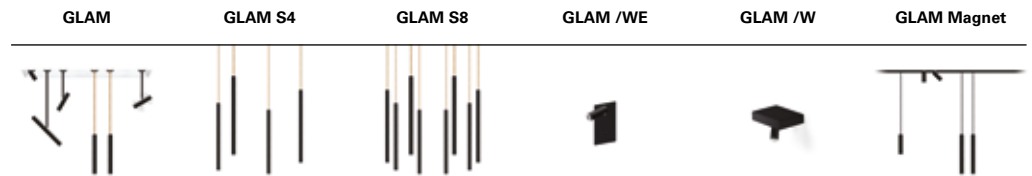

	GLAM	GLAM S4	GLAM S8	GLAM /WE	GLAM /W	GLAM Magnet
Type of application						
Recessed	•			•		
Wall mounted				•	•	
Suspended	•	•	•			•
Spotlights	•					•
Track						•
Light distribution						
Direct	•	•	•	•	•	•
Luminaire diameter						
Ø30 mm	•	•	•	•	•	•
Optical system						
14° lens	•	•	•	•	•	•
47° lens	•	•	•	•	•	•
Oval lens	•	•	•	•	•	•
Colour temperature						
2700K	•	•	•	•	•	•
4000K	•	•	•	•	•	•
Colour						
White; Grey; Black; Sahara; Mist; Carbon; Autumn; Rusty chain; Jungle; Golden eye; Old rose; Copper	•	•	•	•	•	•
Ceiling rose						
Trimless	•					
Recessed	•					
Surface mounted	•	•	•			
Track system						
Trimless						•
Recessed						•
Surface mounted						•
Protection						
IP 20	•	•	•	•	•	
IP 40						•
Adjustable						
	•			•	•	•
Sensor ON/OFF						
				•	•	
USB connection						
					•	
Bespoke projects						
						•



Types of application





1. Individual or continuous line

2. 4 modules suspended

3. 8 modules suspended

4. Wall mounted Recessed

5. Wall mounted Surface mounted

6. Magnetic clip-in system

Optical system

1. 14° lens

2. 47° lens

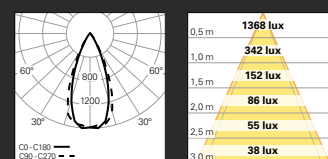
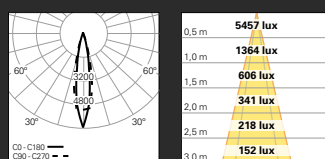

3. Oval lens

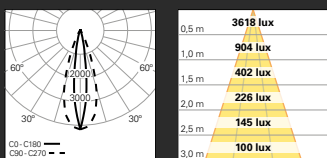
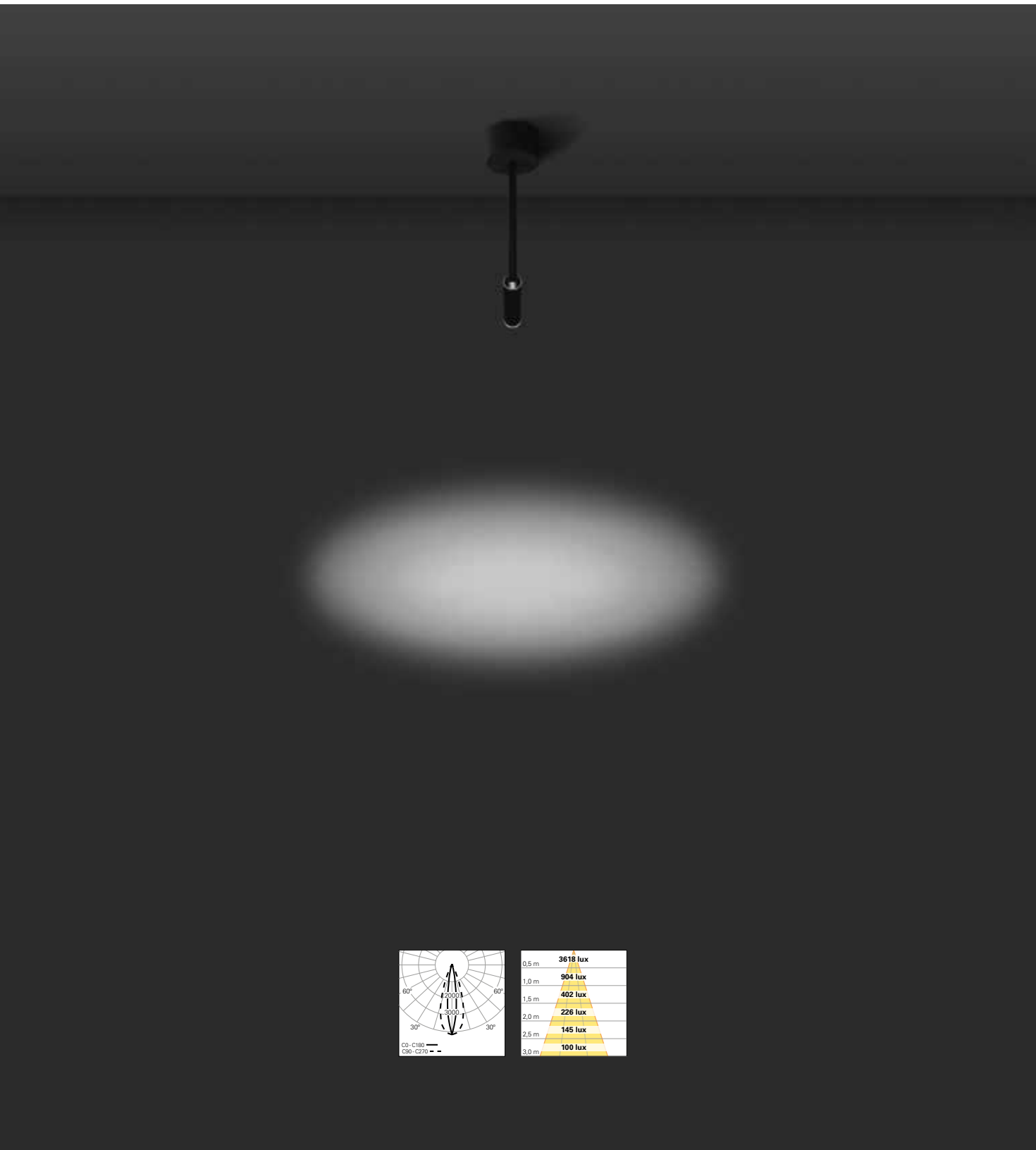

Minimalism and technology



1. Body



2. LED

3. Fixing system

4. Optical system

- 4.1 14° lens
- 4.2 47° lens
- 4.3 Oval lens

5. Decorative trim

6. Current supply cable and fixing system





Define your colour

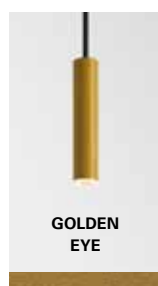



Wall mounted versions



1. 90°+355° rotation

2. ON/OFF sensor

3. USB connection









Magnetic track version

2.2



1.2

1. AVAILABLE MODULES

1.1 Suspended

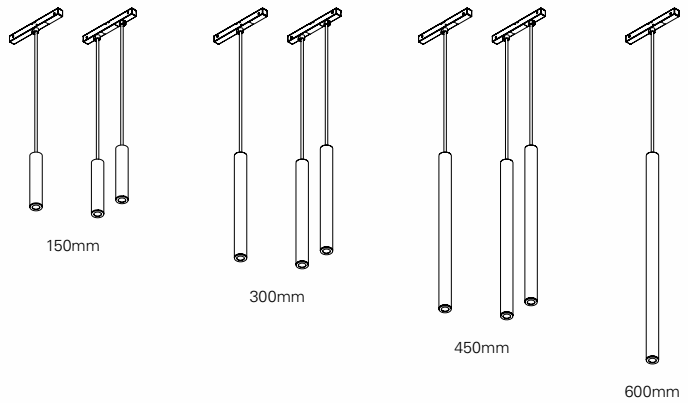

1.2 Spotlights

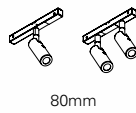

1.3 Line ¹

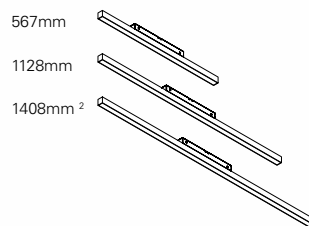

1.1



¹ Available bGLARE and bLINE versions.
² Only available for bLINE version.

1.3

2. MAGNETIC TRACK SYSTEM



2.1 Trimless



74x54mm



2.2 Surface mounted or suspended



26x53mm

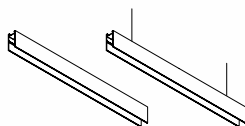

1.1





INDELAGUE GROUP

HEADQUARTERS

INDÚSTRIA ELÉTRICA
DE ÁGUEDA S.A.
Rua da Mina 465 | Covão
Zona industrial EN1 Norte
3750-792 Trofa
ÁGUEDA | PORTUGAL
T. +351 234 612 310
indelague@indelague.pt

SPAIN

INDELAGUE ESPAÑA, S.L.
Avenida del Ejército, nº 8 - 1º C
C.P. 15006 | A CORUÑA | ESPAÑA
comercial@indelague.com

All data contained in this brochure does not constitute any commitment to INDELAGUE - Indústria Eléctrica de Águeda, SA. The company itself, reserves the right to change or modify any information stated without prior notice. The reproduction of this brochure or any part of it is prohibited.